

PRODUCT NO
SEE TABLE

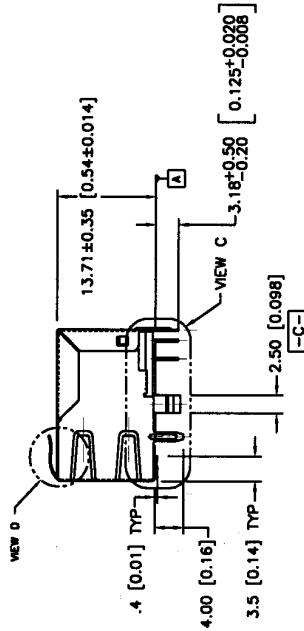
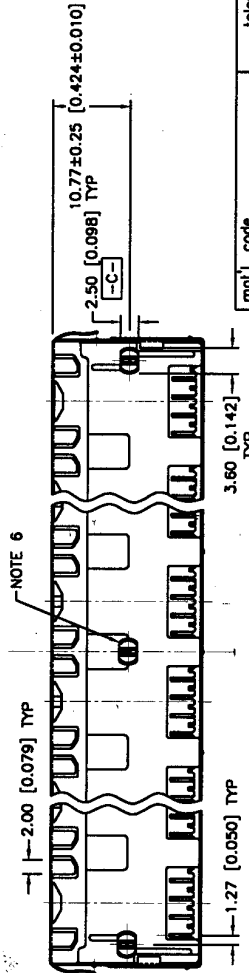
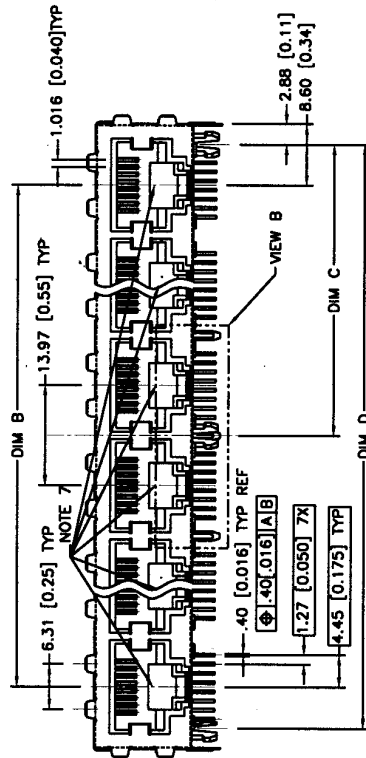
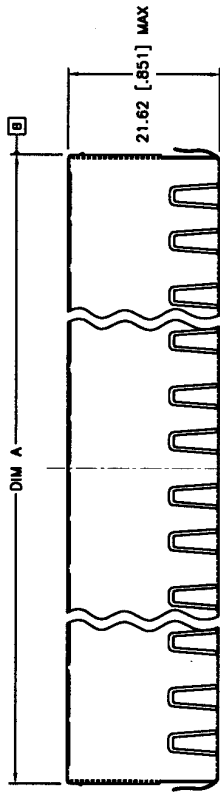

mat'l. code		tolerances unless otherwise specified		CUSTOMER COPY		FCJ	
ltr	ec'n no	dr	date	linear	angular	projection	title
B	V91281	LP	6/9/99	xx ±.01/xx±.3	° ±7	⊕	MPS SERIES, RJ45
C	V92058	LP	10/20/99	xxxx ±.005/xxx±.051			THRU HOLE SNAP PEG ASSY
D	V00653	CSP	7/17/00				product family MOD JACK
E	V10984	BKG	3/9/01	L.POTTEGER	11/16/98		size (dwg no)
F	V12561	LP	10/23/01	B.MARSHALL	11/16/98		code
G	V03-1103	PJ	10/23/01	B.MARSHALL	11/16/98		sheet
H	MDS-0074	MHT	4/22/05	B.MARSHALL	11/16/98		1 of 5
sheet	revision	H	G	H	G		
index	sheet	1	2	3	4	5	

ACAD PDM: Rev:H STATUS:Released 22526 cage code
3 4
Printed: Mar 12, 2007

Tous droits strictement reserves. Reproduction ou communication a des tiers interdite sous quelque forme que ce soit sans autorisation écrite du propriétaire. Propriete de FCJ. Droits de reproduction FCJ.



All rights strictly reserved. Reproduction or issue to third parties in any form whatever is not permitted without written authority from the proprietor.

PRODUCT NO.
SEE TABLE

NOTE 7

13.97 [0.550]

NOTE 7

13.97 [0.550]

SEE NOTE 7

13.97 [0.550]

6.98 [0.275]

1.270 [0.050] 2X

1.270 [0.050] 2X

1.270 [0.050] 3X

1.270 [0.050] 2X

1.270 [0.050]

1.270 [0.050]

1.270 [0.050]

1.270 [0.050]

FOR PORT NO. 4,6,8

FOR PORT NO. 3,5,7

FOR 2-PORT

VIEW B

(CENTER PEG OMITTED FOR CLARITY)

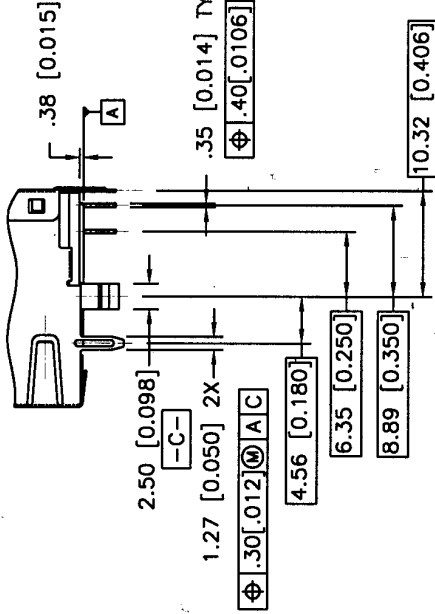

VIEW C

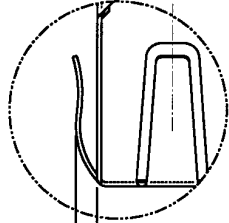

VIEW D

SCALE: 2/1
TYP FOR ALL GROUND SPRINGS

mat'l. code		tolerances unless otherwise specified		CUSTOMER COPY		FCJ	
ltr	ecm no	linear	angles	projection	title	code	sheet
G		.XX ±.01/XX±.3	0° ±2°	⊕	MPS SERIES, RJ45 THRU HOLE SNAP PEG ASSY	213	2 of 5
		.XXXX ±.0020/XXXX.051			product family MOD JACK	code	sheet
					size/dwg no	213	2 of 5
					MM/INCH	74838	
					scale		
					1:1		
sheet	revision						
index	sheet						

ACAD PDM: Rev:H STATUS:Released 22526 cage code 4

Printed: Mar 12, 2007

Tous droits strictement reserves. Reproduction ou communication a des tiers interdite sans queique forme que ce soit sans autorisation ecrite du proprietaire. Propriete de FCJ. Droits de reproduction FCJ.



All rights strictly reserved. Reproduction or issue to third parties in any form whatever is not permitted without written authority from the proprietor. Property of FCJ. Copyright FCJ.

PRODUCT NO. [Ⓢ]	NO. OF PORTS	DIM A +.60[-.024] -00[.000]	DIM B	DIM C ±.10 [-.004]	DIM D ±.15 [-.006]	DIM E ±.13 [-.005]
74838-X02Y	2	31.68 [1.247]	13.97 [0.550]	12.70 [0.500]	25.40 [1.000]	32.11 [1.264]
74838-X03Y	3	45.65 [1.797]	27.94 [1.010]	19.69 [0.775]	39.37 [1.550]	46.08 [1.814]
74838-X04Y	4	59.62 [2.347]	41.91 [1.650]	26.67 [1.050]	53.34 [2.100]	60.05 [2.364]
74838-X05Y	5	73.59 [2.897]	55.88 [2.200]	33.66 [1.325]	67.31 [2.650]	74.02 [2.914]
74838-X06Y	6	87.56 [3.447]	69.85 [2.750]	40.64 [1.600]	81.28 [3.200]	87.99 [3.464]
74838-X07Y	7	101.53 [3.997]	83.82 [3.300]	47.63 [1.875]	95.25 [3.750]	101.96 [4.014]
74838-X08Y	8	115.50 [4.547]	97.79 [3.850]	54.61 [2.150]	109.22 [4.300]	115.93 [4.564]

SPRING OPTION Y	DESCRIPTION (SEE SHEET 5 FOR OPTIONAL VIEWS)
1	SPRING ON TOP,BOTTOM AND BOTH SIDES
2	NO SPRINGS
3	SPRINGS ON TOP AND BOTTOM
4	SPRINGS ON TOP,BOTTOM AND 1 PER. SIDE (STAGGERED)
5	SAME AS OPTION 4 EXCEPT OPPOSITE STAGGER

PLATING CODE X	PLATING [Ⓢ]
0	.76µm/30u" G.X.T.
3	.76µm/30u" GOLD
5	1.27µm/50u" GOLD

NOTE: PLEASE CHECK FOR AVAILABILITY, NOT ALL OPTIONS AVAILABLE

NOTES:

- HOUSING MATL: HIGH TEMP. THERMOPLASTIC, COLOR BLACK, UL94V-0.
- CONTACT MATL: COPPER ALLOY
MATING AREA PLATING: Au OVER Ni. (SEE TABLE).
SOLDER AREA PLATING: 2.54µm/100u" MIN TIN LEAD OVER Ni.
LEAD FREE OPTION:
SOLDER AREA PLATING: 2.54µm/100u" MIN PURE TIN OVER Ni.
- SHIELDING MATL: TIN PLATED COPPER ALLOY.
- ALL DIMENSIONS IN MILLIMETERS AND INCHES.
- SEE SHEET 5 FOR GROUND TAB CONFIGURATION.
- CENTER PEG FOR 8 PORT ONLY.
- COMPANY LOGO LOCATED IN THIS AREA.
- ADD LF SUFFIX AT THE END OF PART NUMBER FOR LEAD FREE OPTION.
- THE HOUSING WILL WITHSTAND EXPOSURE TO 260°C PEAK TEMPERATURE FOR 15 SECONDS IN A WAVE SOLDER APPLICATION WITH A 1.5mm MINIMUM THICK CIRCUIT BOARD. SEE APPLICATION NOTES/PROCEDURES IF THEY ARE AVAILABLE.
- THIS PRODUCT MEETS EUROPEAN UNION DIRECTIVES AND OTHER COUNTRY REGULATION AS DESCRIBED IN GS-22-008.
- PLATING OPTIONS:
MAY BE EITHER GOLD OR GXT PLATED AT MANUFACTURER'S OPTION.

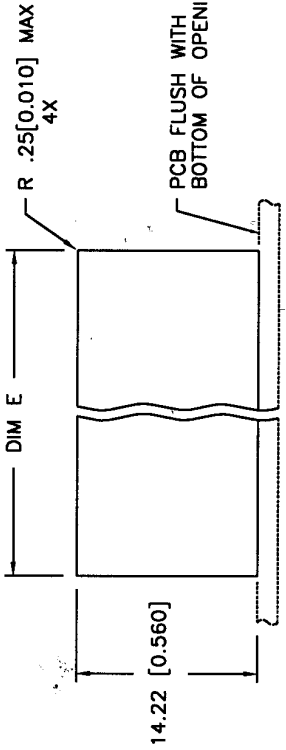

RECOMMENDED PANEL OPENING

mat'l. code		tolerances unless otherwise specified		CUSTOMER COPY	
ltr	ecm no	linear	angles	projection	title
H		.XX ±.01/.XX±.3	0° ±2°	⊕	MPS SERIES, RJ45
		.XXX ±.005/.XXX±.13			THRU HOLE SNAP PEG ASSY
		.XXXX ±.0020/.XXX±.051			product family MOD JACK
					size dwg no
					A
					code
					213
					sheet
					3 of 5

ACAD 3 PDM: Rev:H STATUS:Released 22526 Printed: Mar 12, 2007

Tous droits strictement reserves. Reproduction ou communication a des tiers interdite sous quelque forme que ce soit sans autorisation écrite du propriétaire. Property of FCI. Copyright FCI.



All rights strictly reserved. Reproduction or issue to third parties in any form whatever is not permitted without written authority from the proprietor.

PRODUCT NO.
SEE TABLE

Tous droits strictement réservés. Reproduction ou communication à des tiers interdite sans aucune forme que ce soit sans autorisation écrite du propriétaire. Propriété de C.FCI. Droits de reproduction FCI.



All rights strictly reserved. Reproduction or issue to third parties in any form whatever is not permitted without written authority from the proprietor. Property of FCI. Copyright FCI.

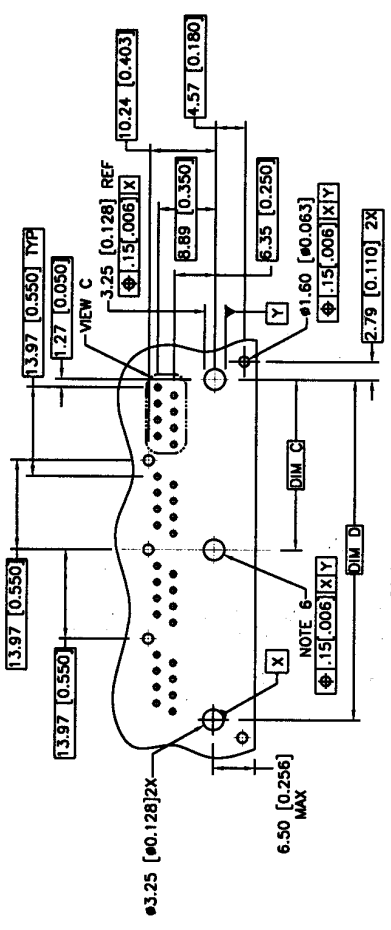

VIEW C
SCALE 2/1
TYPICAL FOOTPRINT

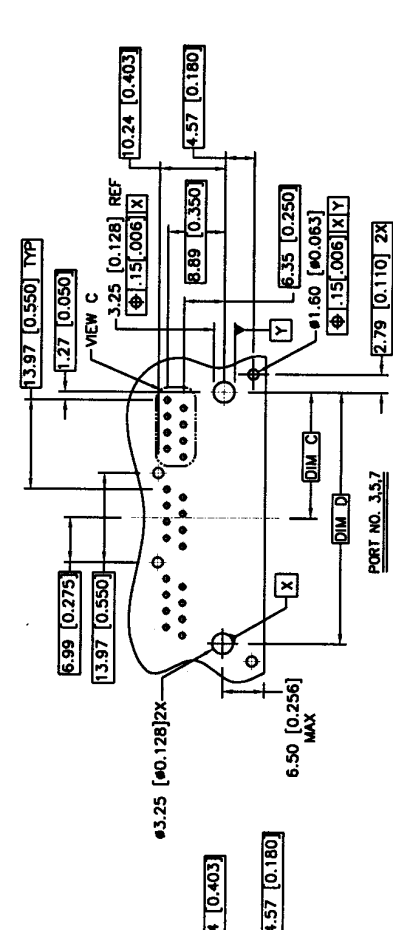

RECOMMENDED P.C.B LAYOUT
AS VIEWED FROM TOP SIDE (COMPONENT SIDE)

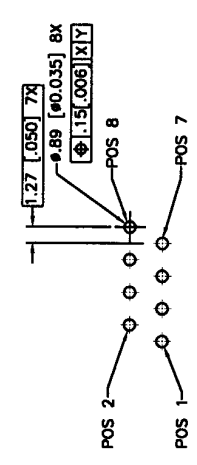

mat'l. code		tolerances unless otherwise specified		CUSTOMER COPY		www.fciconnect.com	
ltr	ecr no	dr	date	linear	angles	projection	title
G				.XX ±.01/XX±.3	0° ±.2°	⊕	MPS SERIES, RJ45
				.XXX ±.0020/XXX±.051			THRU HOLE SNAP PEG ASSY
							product family MOD JACK
							code 213
							size/dwg no A
							sheet 4 of 5
							scale 1:1
sheet index	revision sheet						code code 22526
							74838
							code code 22526
							Printed: Mar 12, 2007

ACAD PDM: Rev:H STATUS:Released

PRODUCT NO
SEE TABLE

SPRING TAB CONFIGURATION OPTION Y

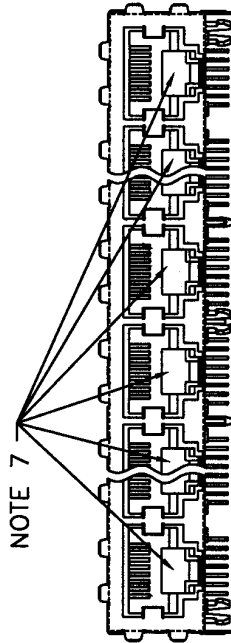

SPRING OPTION 1

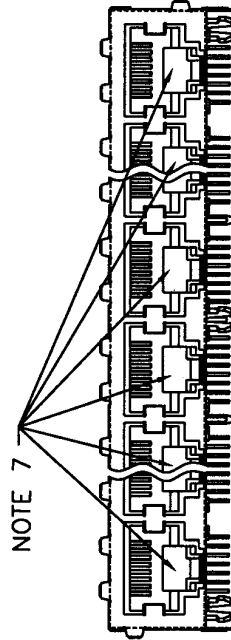

SPRING OPTION 4

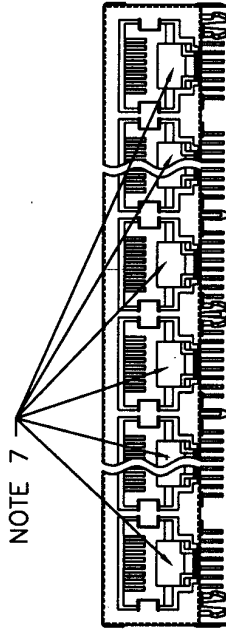

SPRING OPTION 2

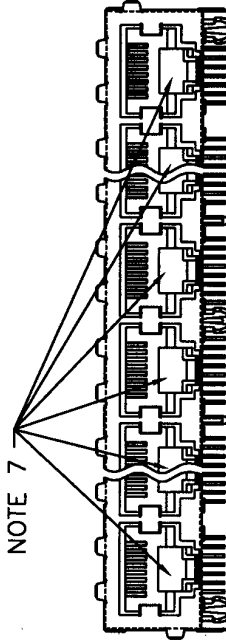

SPRING OPTION 5

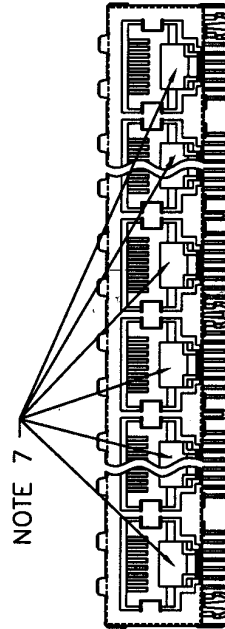

SPRING OPTION 3

Tous droits strictement réservés. Reproduction ou communication à des tiers interdite sous quelque forme que ce soit sans autorisation écrite du propriétaire. Propriété de © FCI. Droits de reproduction FCI.



All rights strictly reserved. Reproduction or issue to third parties in any form whatever is not permitted without written authority from the proprietor. Property of FCI. Copyright FCI.

mat'l. code		tolerances unless otherwise specified		CUSTOMER COPY		FCI	
lir	ecrn no	linear	.XX ±.01/.XX±.3	projection	title	www.fciconnect.com	
G		angles	.XXX ±.005/.XXX±.13	MM/INCH	MPS SERIES, RJ45		
	dr	dr	L.POTEIGER 11/16/98	score	THRU HOLE SNAP PEG ASSY	product family	MOD JACK
	date	engr	B.MARSHALL 11/16/98	1:1	A	size	213
		clir	B.MARSHALL 11/16/98			sheet	5 of 5
		appd	B.MARSHALL 11/16/98				
sheet	revision						
index	sheet						