

Tous droits strictement réservés. Reproduction ou communication à des tiers interdite sous quelque forme que ce soit sans autorisation écrite du propriétaire. Propriété de c FCI. Droits de reproduction FCI.

All rights strictly reserved. Reproduction or issue to third parties in any form whatever is not permitted without written authority from the proprietor. Property of FCI. Copyright FCI.

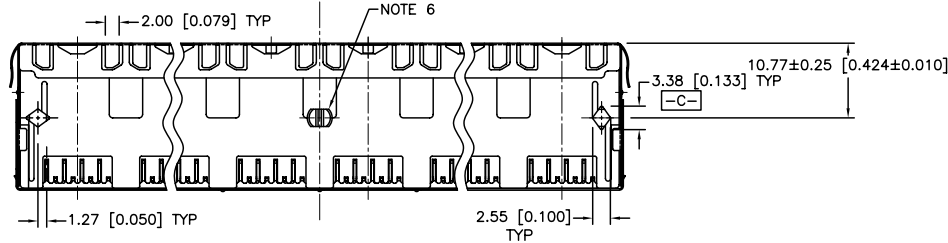

PRODUCT NO  
SEE TABLE

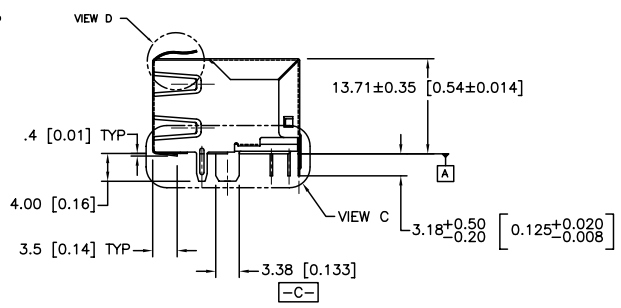
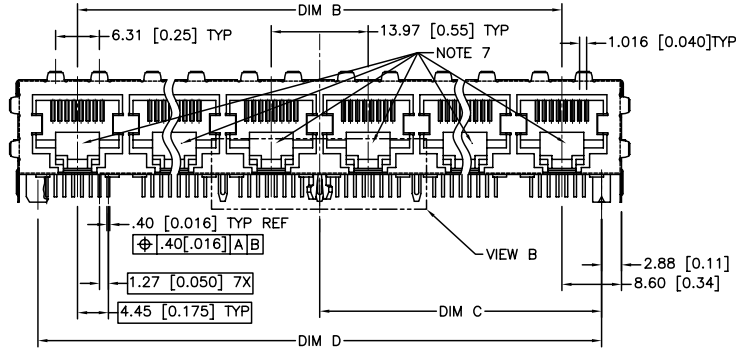
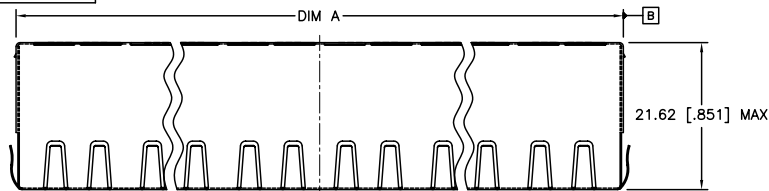

mat'l. code				tolerances unless otherwise specified				CUSTOMER COPY		FCI www.fciconnect.com	
ltr	ecn no	dr	date	linear	.xx ±.01/.X±.3	projection	title		MPS SERIES, RJ45		
B	V91281	LP	6/9/99		.xxx ±.005/.xx±.13		THRU HOLE DIAMOND PEG ASSY		code		
C	V92058	LP	10/20/99		.xxx ±.0020/.xxx±.051		product family		MOD JACK		
D	V00653	CSP	7/17/00	angles	0° ±2°	MM/INCH	size		213		
E	V10984	BKB	3/13/01	dr	L.POTTEIGER 11/16/98	scale	A		74839		
F	V12561	LP	10/23/01	enfr	B.MARSHALL 11/16/98	1:1	sheet		1 of 5		
G	V03-1103	PJ	10/20/03	chr	B.MARSHALL 11/16/98		sheet				
H	M05-0074	MHT	4/23/05	appd	B.MARSHALL 11/16/98		sheet				
sheet	revision	H	G	H	G	G	cage code		22526		
index	sheet	1	2	3	4	5	4				

ACAD PDM: Rev:H STATUS: Released Printed: May 18, 2005

Tous droits strictement réservés. Reproduction ou communication à des tiers interdite sous quelque forme que ce soit sans autorisation écrite du propriétaire. Property of FCI. Droits de reproduction FCI.

**FCI**

All rights strictly reserved. Reproduction or issue to third parties in any form whatever is not permitted without written authority from the proprietor. Property of FCI. Copyright FCI.

PRODUCT NO.  
SEE TABLE

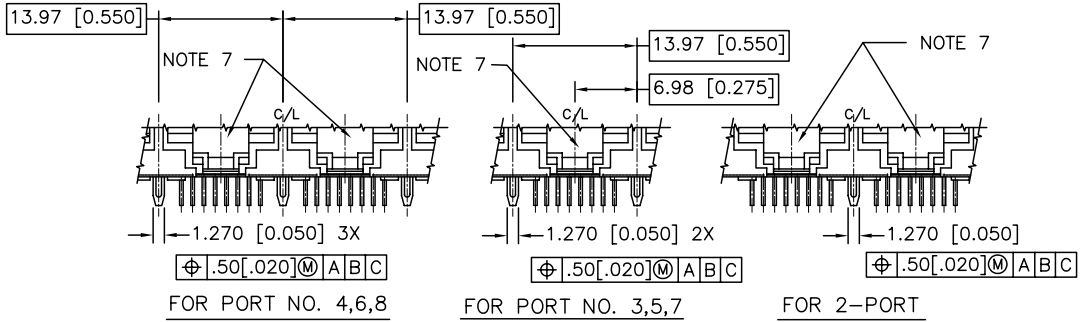

VIEW B  
(CENTER PEG OMITTED FOR CLARITY)

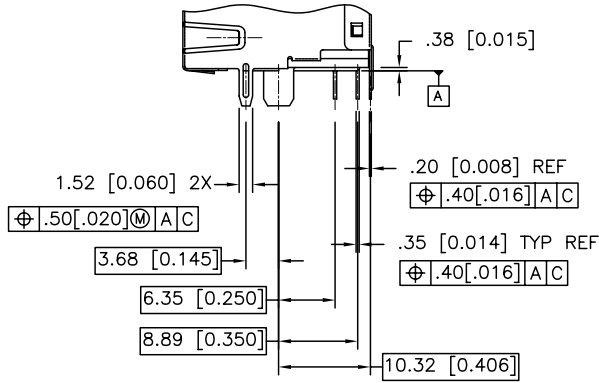

VIEW C

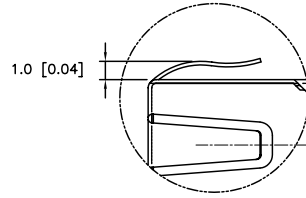

VIEW D  
SCALE: 2/1  
TYP FOR ALL GROUND SPRINGS

mat'l. code				tolerances unless otherwise specified				CUSTOMER COPY		 www.fciconnect.com			
ltr	ecn no	dr	date	linear	.xx ±.01/.X±.3		projection	 title		MPS SERIES, RJ45			
G					.xxx ±.005/.xx±.13					THRU HOLE DIAMOND PEG ASSY			
					.xxx ±.0020/.xxx±.051					product family MOD JACK		code	
					0° ±2°					size		213	
				angles	0° ±2°		MM/INCH	A		sheet			
				dr	L.POTTEIGER	11/16/98				scale		2 of 5	
				engr	B.MARSHALL	11/16/98				1:1		74839	
				chr	B.MARSHALL	11/16/98							
				appd	B.MARSHALL	11/16/98							
sheet index	revision sheet									cage code			
										22526			

ACAD

PDM: Rev:H

STATUS: Released

Printed: May 18, 2005

1 | 2

3

4

Tous droits strictement réservés. Reproduction ou communication à des tiers interdite sous quelque forme que ce soit sans autorisation écrite du propriétaire. Property of FCI. Droits de reproduction FCI.

All rights strictly reserved. Reproduction or issue to third parties in any form whatever is not permitted without written authority from the proprietor. Property of FCI. Copyright FCI.

PRODUCT NO. ⑥	NO. OF PORTS	DIM A <sup>+0.60</sup> <sub>-00</sub> [.024][.000]	DIM B	DIM C <sup>±.10</sup> <sub>±.004</sub>	DIM D <sup>±.15</sup> <sub>±.006</sub>	DIM E <sup>±.13</sup> <sub>±.005</sub>
74839-X02Y	2	31.68 [1.247]	13.97 [0.550]	12.70 [0.500]	25.40 [1.000]	32.11 [1.264]
74839-X03Y	3	45.65 [1.797]	27.94 [1.010]	19.69 [0.775]	39.37 [1.550]	46.08 [1.814]
74839-X04Y	4	59.62 [2.347]	41.91 [1.650]	26.67 [1.050]	53.34 [2.100]	60.05 [2.364]
74839-X05Y	5	73.59 [2.897]	55.88 [2.200]	33.66 [1.325]	67.31 [2.650]	74.02 [2.914]
74839-X06Y	6	87.56 [3.447]	69.85 [2.750]	40.64 [1.600]	81.28 [3.200]	87.99 [3.464]
74839-X07Y	7	101.53 [3.997]	83.82 [3.300]	47.63 [1.875]	95.25 [3.750]	101.96 [4.014]
74839-X08Y	8	115.50 [4.547]	97.79 [3.850]	54.61 [2.150]	109.22 [4.300]	115.93 [4.564]

NOTE: PLEASE CHECK FOR AVAILABILITY, NOT ALL OPTIONS AVAILABLE.

SPRING OPTION Y	DESCRIPTION (SEE SHEET 5 FOR OPTIONAL VIEWS)
1	SPRING ON TOP,BOTTOM AND BOTH SIDES
2	NO SPRINGS
3	SPRINGS ON TOP AND BOTTOM
4	SPRINGS ON TOP,BOTTOM AND 1 PER SIDE (STAGGERED)
5	SAME AS OPTION 4 EXCEPT OPPOSITE STAGGER

PLATING CODE X	PLATING ⑪
0	.76uM/30u" G.X.T.
3	.76uM/30u" GOLD
5	1.27uM/50u" GOLD

NOTES:

- HOUSING MATL: HIGH TEMP. THERMOPLASTIC, COLOR BLACK, UL94V-0.
- CONTACT MATL: COPPER ALLOY  
MATING AREA PLATING: Au OVER Ni., (SEE TABLE).  
SOLDER AREA PLATING: 2.54uM/100u" MIN TIN LEAD OVER Ni.  
LEAD FREE OPTION:  
SOLDER AREA PLATING: 2.54uM/100u" MIN PURE TIN OVER Ni.
- SHIELDING MAT'L: TIN PLATED COPPER ALLOY.
- ALL DIMENSIONS IN MILLIMETERS AND INCHES.
- SEE SHEET 5 FOR GROUND TAB CONFIGURATION.
- CENTER PEG FOR 8 PORT ONLY.
- COMPANY LOGO LOCATED IN THIS AREA.
- ADD LF SUFFIX AT THE END OF PART NUMBER FOR LEAD FREE OPTION.
- THE HOUSING WILL WITHSTAND EXPOSURE TO 260°C PEAK TEMPERATURE FOR 15 SECONDS IN A WAVE SOLDER APPLICATION WITH A 1.5mm MINIMUM THICK CIRCUIT BOARD. SEE APPLICATION NOTES/PROCEDURES IF THEY ARE AVAILABLE.
- THIS PRODUCT MEETS EUROPEAN UNION DIRECTIVES AND OTHER COUNTRY REGULATION AS DESCRIBED IN GS-22-008.
- PLATING OPTIONS:  
MAY BE EITHER GOLD OR GXT PLATED AT MANUFACTURER'S OPTION.

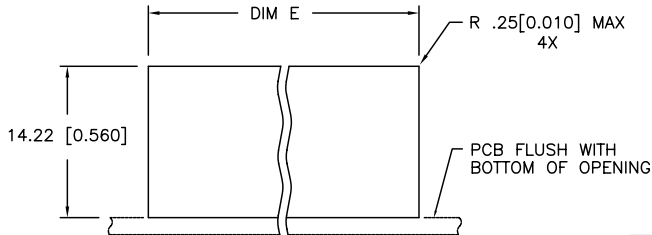

RECOMMENDED PANEL OPENING

mat'l. code				tolerances unless otherwise specified		CUSTOMER COPY		FCI www.fciconnect.com	
ltr	ecn no	dr	date	linear	.XX ±.01/.XX±.3	projection	title	MPS SERIES, RJ45 THRU HOLE DIAMOND PEG ASSY	
H					.XXX ±.005/.XX±.13			product family	MOD JACK
					.XXX ±.0020/.XXX±.051			size	dwg no
				angles	0° ±2°	MM/INCH	A	74839	213
				dr	L.POTTEIGER 11/16/98	scale	1:1		sheet
				engr	B.MARSHALL 11/16/98				3 of 5
				chr	B.MARSHALL 11/16/98				
				appd	B.MARSHALL 11/16/98				
sheet index	revision sheet							cage code	
								22526	

ACAD

PDM: Rev:H

STATUS: Released

Printed: May 18, 200

1 | 2

3

4



1 | 2

3 |

4

PRODUCT NO  
SEE TABLE

# SPRING TAB CONFIGURATION OPTION Y

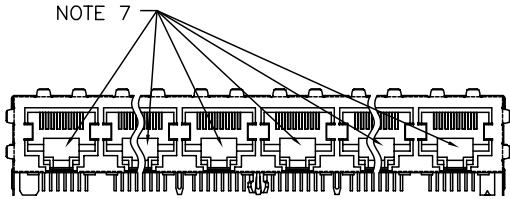

SPRING OPTION 1

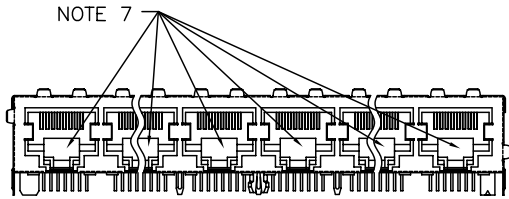

SPRING OPTION 4

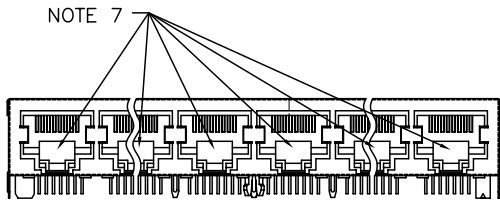

SPRING OPTION 2

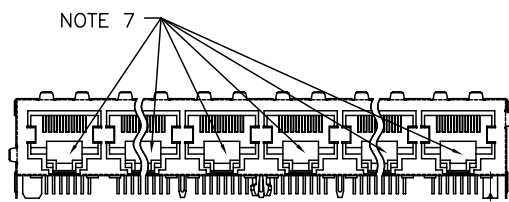

SPRING OPTION 5

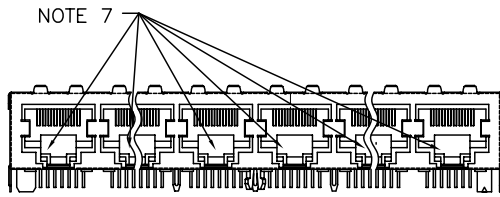



SPRING OPTION 3

Tous droits strictement réservés. Reproduction ou communication à des tiers interdite sous quelque forme que ce soit sans autorisation écrite du propriétaire. Propriété de c FCI. Droits de reproduction FCI.



All rights strictly reserved. Reproduction or issue to third parties in any form whatever is not permitted without written authority from the proprietor. Property of FCI. Copyright FCI.

mat'l. code		tolerances unless otherwise specified		CUSTOMER COPY		 www.fciconnect.com	
ltr	ecn no	dr	date	linear	.xx ±.01/.X±.3	projection	title
G					.xxx ±.005/.xx±.13	 MM/INCH	MPS SERIES, RJ45
				angles	.xxx ±.0020/.xxx±.051		THRU HOLE DIAMOND PEG ASSY
				dr	0° ±2°	scale	product family MOD JACK
				engr	L.POTTEIGER 11/16/98	1:1	code
				chr	B.MARSHALL 11/16/98		213
				appd	B.MARSHALL 11/16/98		sheet
sheet index	revision sheet						5 of 5

1 | 2

3 |

4

ACAD

PDM: Rev:H

STATUS: Released

cage code  
22526

Printed: May 18, 2005