



## Single Port Modular Jacks

### Product Facts

- Meets or exceeds FCC Part 68 rules and regulations; REA PE-76; and UL 1863, Communication Circuit Accessories
- Meets 1000 volt dielectric requirement Contact to Contact
- Available in both top and side entry (Right-Angle)
- Designed for direct mounting on pc boards
- Designed for ease of soldering and board cleaning
- Available in both shielded and unshielded versions
- Shielded jack available with two grounding paths - pc board and panel
- 20 dB shielding effectiveness from 30 MHz to 400 MHz
- Selectively gold plated contacts for lower cost
- All jacks are UL 94V-0 flame retardant polyester, standard color black, unless specified otherwise
- Listed by Underwriters Laboratories Inc., File No. E81956 
- Certified by Canadian Standards Association, File No. LR 7189A 
- Produced under a Quality Management System Certified to ISO 9001  
A copy of the certificate is available upon request

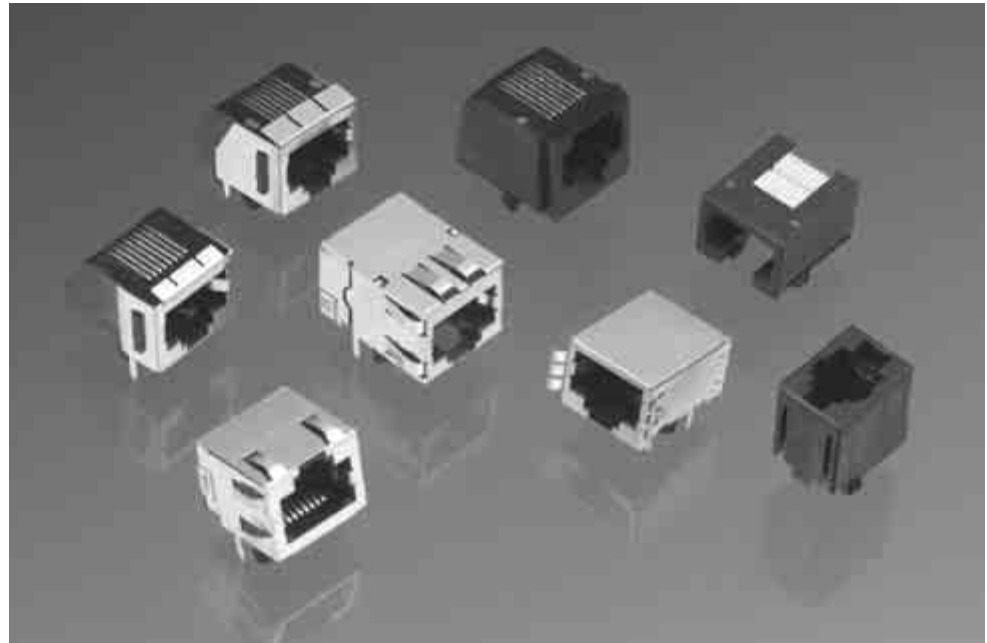

### Specifications

#### Electrical

**Current Rating** — 1.5 amp max. @ 25°C, derated to 0.2 amp max. @ 70°C ambient

**Voltage Rating** — 150 volts AC max.

**Dielectric Withstanding Voltage** — 1000 VAC, RMS, 60 Hz, 1 min. Contact to Contact

#### Mechanical

**PC Board Retention** — will not dislodge from pc board when subjected to 1 lb. [4.4N] pull before soldering and 10 lb. [44N] pull after soldering

**Durability** — 750 mating cycles

### Material and Finish

**Housing** — Through-hole: Polyester (wave solder compatible), UL 94V-0 rated; Surface Mount: Polyphenylene Sulfide, or High Temp Nylon, UL 94V-0 rated

**Contact** — .014 [0.36] thk. Phosphor bronze; plated .000050 [0.00127] gold in contact area and .000150 [0.00381] tin-lead on solder tails, over .000050 [0.00127] nickel underplate

### Technical Documents

**Application Specifications**  
114-02048  
114-6040

**Product Specifications**  
108-01163  
108-01163-1  
108-01163-3  
108-01163-4  
108-01163-7

**Single Port Modular Jacks (Continued)**

**Side Entry (RA), Thru-Hole**

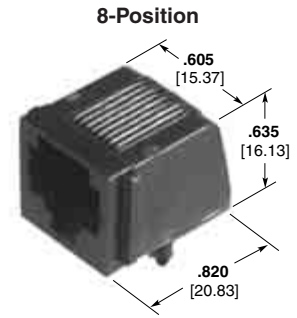

| Part Number | Positions/Contacts | LEDs    | Shielded | Performance | Panel Stops | Inverted | Ground Options |
|-------------|--------------------|---------|----------|-------------|-------------|----------|----------------|
| 215875-1    | 4/4                | Without | No       | Cat 3       | Without     | No       | Without        |
| 2-215875-1  | 4/4                | Without | No       | Cat 3       | Without     | No       | Without        |
| 5520249-2   | 4/4                | Without | No       | Cat 3       | With        | No       | Without        |
| 215876-2    | 6/4                | Without | No       | Cat 3       | Without     | No       | Without        |
| 5555140-2   | 6/4                | Without | Yes      | Cat 3       | With        | No       | Panel and PCB  |
| 5555163-2   | 6/4                | Without | No       | Cat 3       | With        | No       | Without        |
| 1-215876-3  | 6/6                | Without | No       | Cat 3       | Without     | No       | Without        |
| 215876-1    | 6/6                | Without | No       | Cat 3       | N/A         | No       | Without        |
| 5520250-3   | 6/6                | Without | No       | Cat 3       | With        | No       | Without        |
| 5555003-1   | 6/6                | Without | No       | Cat 3       | With        | No       | Without        |
| 5555140-1   | 6/6                | Without | Yes      | Cat 3       | With        | No       | Panel and PCB  |
| 5555154-1   | 6/6                | Without | Yes      | Cat 3       | With        | No       | PCB Ground     |
| 5555163-1   | 6/6                | Without | No       | Cat 3       | With        | No       | Without        |
| 5555165-1   | 6/6                | Without | No       | Cat 3       | Without     | No       | Without        |
| 106066-2    | 8/8                | Without | Yes      | Cat 3       | Without     | No       | Panel and PCB  |
| 1116062-2   | 8/8                | Without | Yes      | Cat 5       | Without     | No       | Panel and PCB  |
| 1116503-2   | 8/8                | Without | Yes      | Cat 5       | Without     | No       | PCB Ground     |
| 6116526-1   | 8/8                | Without | Yes      | Cat 5       | Without     | No       | PCB Ground     |
| 1-215877-3  | 8/8                | Without | No       | Cat 3       | Without     | No       | Without        |

**Note:** Consult Tyco Electronics Sales Representative for additional Part Numbers and features differences (tail length, LED color, IRR, etc.)

**Low Profile, Face Shield**

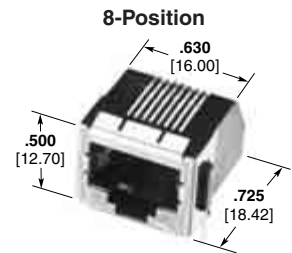
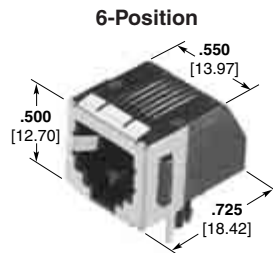
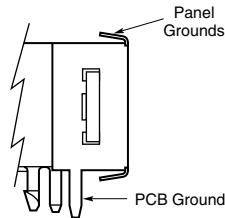

| Part Number | Positions/Contacts | LEDs    | Shielded | Performance | Panel Stops | Inverted | Ground Options |
|-------------|--------------------|---------|----------|-------------|-------------|----------|----------------|
| 5555162-1   | 8/8                | Without | No       | Cat 3       | With        | No       | Without        |
| 5555164-1   | 8/8                | Without | No       | Cat 3       | Without     | No       | Without        |
| 1-5406299-1 | 8/8                | Without | Yes      | Cat 5       | Without     | No       | Panel and PCB  |
| 1-1734264-1 | 8/8                | Without | Yes      | Cat 3       | Without     | No       | Panel and PCB  |
| 1734579-1   | 8/8                | Without | Yes      | Cat 3       | Without     | No       | PCB Ground     |
| 215877-1    | 8/8                | Without | No       | Cat 3       | Without     | No       | Without        |
| 2-215877-1  | 8/8                | Without | No       | Cat 3       | Without     | No       | Without        |
| 2-215878-1  | 8/8                | Without | No       | Cat 3       | Without     | No       | Without        |
| 2-5338556-1 | 8/8                | Without | Yes      | Cat 3       | Without     | No       | Panel and PCB  |
| 3-5338556-1 | 8/8                | Without | Yes      | Cat 3       | Without     | No       | Panel and PCB  |
| 5406217-1   | 8/8                | Without | Yes      | Cat 5       | Without     | No       | Panel and PCB  |
| 5406296-1   | 8/8                | Without | Yes      | Cat 5       | Without     | No       | Panel and PCB  |

**Note:** Consult Tyco Electronics Sales Representative for additional Part Numbers and features differences (tail length, LED color, IRR, etc.)

**Note:** All part numbers are RoHS compliant.

### Single Port Modular Jacks (Continued)

#### Side Entry (RA), Thru-Hole

#### Low Profile, Face Shield (Continued)

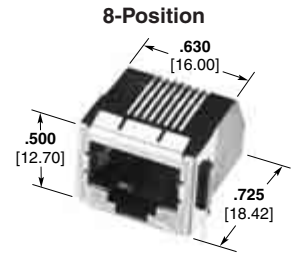
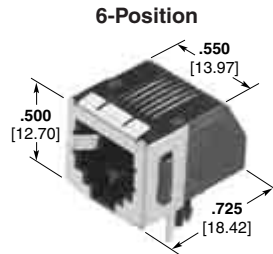
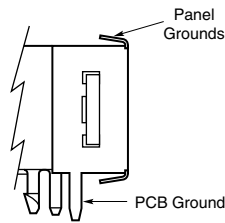

| Part Number | Positions/Contacts | LEDs    | Shielded | Performance | Panel Stops | Inverted | Ground Options |
|-------------|--------------------|---------|----------|-------------|-------------|----------|----------------|
| 5406299-1   | 8/8                | Without | Yes      | Cat 5       | Without     | No       | Panel and PCB  |
| 1-406525-1  | 8/8                | Without | No       | Cat 5       | Without     | Yes      | Without        |
| 1-406541-1  | 8/8                | Without | Yes      | Cat 5       | Without     | Yes      | Panel and PCB  |
| 5520243-4   | 8/8                | Without | No       | Cat 3       | Without     | No       | Without        |
| 5520251-4   | 8/8                | Without | No       | Cat 3       | With        | No       | Without        |
| 5520426-4   | 8/8                | Without | No       | Cat 3       | Without     | No       | Without        |
| 5555141-1   | 8/8                | Without | Yes      | Cat 3       | Without     | No       | Panel and PCB  |
| 5555153-1   | 8/8                | Without | Yes      | Cat 3       | With        | No       | PCB Ground     |
| 5555153-3   | 8/8                | Without | Yes      | Cat 3       | With        | No       | PCB Ground     |

**Note:** Consult Tyco Electronics Sales Representative for additional Part Numbers and features differences (tail length, LED color, IRR, etc.)

#### Side Entry (RA), Thru-Hole

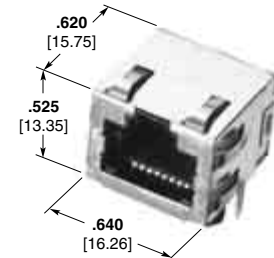
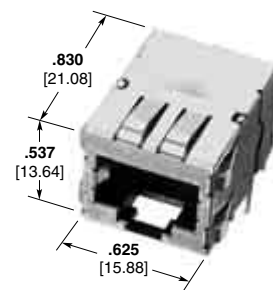
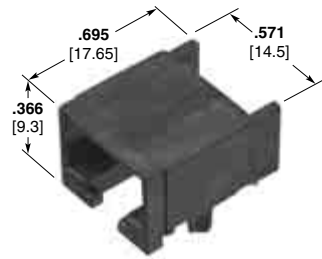

| Part Number | Positions/Contacts | LEDs    | Shielded | Performance | Panel Stops | Inverted | Ground Options |
|-------------|--------------------|---------|----------|-------------|-------------|----------|----------------|
| 5555166-1   | 8/8                | Without | No       | Cat 3       | With        | No       | Without        |
| 5555167-1   | 8/8                | Without | No       | Cat 3       | Without     | No       | Without        |
| 5557785-1   | 8/8                | Without | No       | Cat 3       | Without     | No       | Without        |
| 5557789-1   | 8/8                | Without | Yes      | Cat 3       | Without     | No       | PCB Ground     |
| 5557791-1   | 8/8                | Without | Yes      | Cat 3       | Without     | No       | Panel and PCB  |
| 5558341-1   | 8/8                | Without | No       | Cat 5       | Without     | No       | Without        |
| 5558342-1   | 8/8                | Without | Yes      | Cat 5       | Without     | No       | PCB Ground     |
| 5558344-1   | 8/8                | Without | Yes      | Cat 5       | Without     | No       | Panel and PCB  |
| 5569115-1   | 8/8                | Without | Yes      | Cat 3       | With        | No       | Panel and PCB  |
| 5569118-1   | 8/8                | Without | No       | Cat 3       | Without     | No       | Without        |
| 6116075-1   | 8/8                | With    | Yes      | Cat 5       | Without     | Yes      | PCB Ground     |
| 6116173-1   | 8/8                | With    | Yes      | Cat 5       | Without     | Yes      | Panel and PCB  |
| 6364139-5   | 8/8                | With    | No       | Cat 5       | Without     | Yes      | Without        |
| 1734509-2   | 8/8                | With    | Yes      | Cat 3       | Without     | No       | PCB Ground     |
| 5406533-1   | 8/8                | With    | No       | Cat 5       | Without     | Yes      | Without        |
| 2-406549-1  | 8/8                | With    | Yes      | Cat 5       | Without     | Yes      | Panel and PCB  |
| 2-406549-4  | 8/8                | With    | Yes      | Cat 5       | Without     | Yes      | Panel and PCB  |
| 5569564-1   | 8/8                | With    | Yes      | Cat 3       | Without     | No       | Panel and PCB  |
| 1734542-5   | 10/10              | Without | No       | Cat 3       | Without     | No       | Without        |
| 5558065-1   | 10/10              | Without | No       | Cat 3       | Without     | No       | Without        |
| 5558067-1   | 10/10              | Without | Yes      | Cat 3       | Without     | No       | PCB Ground     |
| 5558070-1   | 10/10              | Without | Yes      | Cat 3       | Without     | No       | Panel and PCB  |

**Note:** Consult Tyco Electronics Sales Representative for additional Part Numbers and features differences (tail length, LED color, IRR, etc.)

**Note:** All part numbers are RoHS compliant.

**Single Port Modular Jacks (Continued)**

**Side Entry (RA),  
Surface Mount**

Single Port  
Modular Jacks

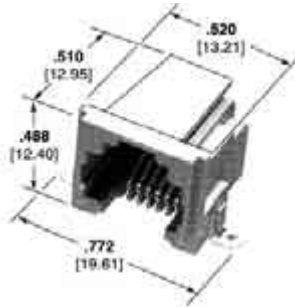

1339212-1

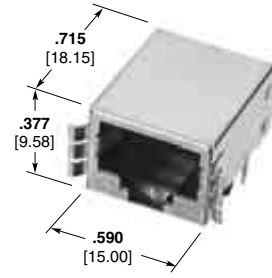

1339212-1

| Part Number | Positions/Contacts | LEDs    | Shielded | Performance | Panel Stops | Inverted | Ground Options |
|-------------|--------------------|---------|----------|-------------|-------------|----------|----------------|
| 6339212-1   | 6/6                | Without | Yes      | Cat 3       | Without     | Yes      | Panel and PCB  |
| 5406514-2   | 6/6                | Without | No       | Cat 3       | Without     | Yes      | Without        |
| 5555077-1   | 6/6                | Without | No       | Cat 3       | With        | No       | Without        |
| 6339160-1   | 8/8                | Without | Yes      | Cat 3       | Without     | Yes      | Panel and PCB  |
| 5406721-1   | 8/8                | Without | No       | Cat 3       | With        | Yes      | Without        |
| 5406721-2   | 8/8                | Without | No       | Cat 3       | With        | Yes      | Without        |
| 5558178-1   | 8/8                | Without | Yes      | Cat 3       | With        | No       | PCB Ground     |

**Note:** Consult Tyco Electronics Sales Representative for additional Part Numbers and features differences (tail length, LED color, IRR, etc.)

**Top Entry, Thru-Hole**

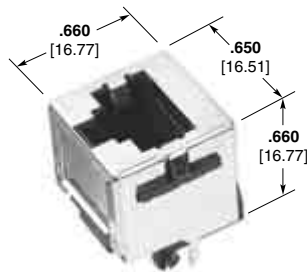

Shielded 557484-1

| Part Number | Positions/Contacts | LEDs    | Shielded | Performance | Panel Stops | Inverted | Ground Options |
|-------------|--------------------|---------|----------|-------------|-------------|----------|----------------|
| 5520257-2   | 4/4                | Without | No       | Cat 3       | With        | No       | Without        |
| 5406010-2   | 6/2                | Without | No       | Cat 3       | Without     | No       | Without        |
| 5520258-2   | 6/4                | Without | No       | Cat 3       | With        | No       | Without        |

**Note:** Consult Tyco Electronics Sales Representative for additional Part Numbers and features differences (tail length, LED color, IRR, etc.)

**Note:** All part numbers are RoHS compliant.

**Single Port Modular Jacks** (Continued)

**Top Entry, Thru-Hole**



| Part Number | Positions/Contacts | LEDs    | Shielded | Performance | Panel Stops | Inverted | Ground Options |
|-------------|--------------------|---------|----------|-------------|-------------|----------|----------------|
| 5520425-2   | 6/4                | Without | No       | Cat 3       | Without     | No       | Without        |
| 216548-1    | 6/6                | Without | No       | Cat 3       | With        | No       | Without        |
| 216564-1    | 6/6                | Without | No       | Cat 3       | With        | No       | Without        |
| 5520258-3   | 6/6                | Without | No       | Cat 3       | With        | No       | Without        |
| 5520425-3   | 6/6                | Without | No       | Cat 3       | Without     | No       | Without        |
| 5554990-1   | 6/6                | Without | No       | Cat 3       | With        | No       | Without        |
| 100616-1    | 8/8                | Without | Yes      | Cat 3       | With        | No       | PCB Ground     |
| 100616-2    | 8/8                | Without | Yes      | Cat 3       | With        | No       | PCB Ground     |
| 6116202-1   | 8/8                | Without | Yes      | Cat 5       | Without     | No       | PCB Ground     |
| 216550-1    | 8/8                | Without | No       | Cat 3       | With        | No       | Without        |
| 216566-1    | 8/8                | Without | No       | Cat 3       | With        | No       | Without        |
| 5520259-4   | 8/8                | Without | No       | Cat 3       | With        | No       | Without        |
| 555799-1    | 8/8                | Without | No       | Cat 3       | Without     | No       | Without        |
| 5556416-1   | 8/8                | Without | No       | Cat 3       | Without     | No       | Without        |
| 5557484-1   | 8/8                | Without | Yes      | Cat 3       | With        | No       | Panel and PCB  |
| 5557730-1   | 8/8                | Without | Yes      | Cat 3       | With        | No       | Panel and PCB  |
| 5557969-1   | 8/8                | Without | Yes      | Cat 3       | With        | No       | Panel and PCB  |
| 5557969-2   | 8/8                | Without | Yes      | Cat 3       | With        | No       | Panel and PCB  |

**Note:** Consult Tyco Electronics Sales Representative for additional Part Numbers and features differences (tail length, LED color, IRR, etc.)

**Top Entry, Surface Mount**

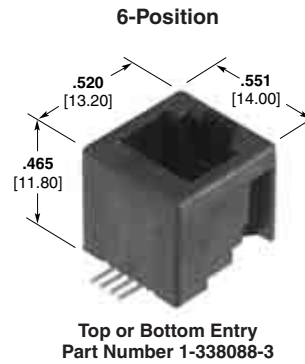

| Part Number | Positions/Contacts | LEDs    | Shielded | Performance | Panel Stops | Inverted | Ground Options |
|-------------|--------------------|---------|----------|-------------|-------------|----------|----------------|
| 1-338084-3  | 4/4                | Without | No       | Cat 3       | Without     | No       | Without        |
| 1-338086-3  | 6/6                | Without | No       | Cat 3       | Without     | No       | Without        |
| 2-338086-3  | 6/6                | Without | No       | Cat 3       | Without     | No       | Without        |
| 1-338088-3  | 8/8                | Without | No       | Cat 3       | Without     | No       | Without        |
| 2-338088-3  | 8/8                | Without | No       | Cat 3       | Without     | No       | Without        |

**Note:** Consult Tyco Electronics Sales Representative for additional Part Numbers and features differences (tail length, LED color, IRR, etc.)

**Note:** All part numbers are RoHS compliant.

**Single Port Modular Jacks (Continued)**

**Top Entry, Press Fit**

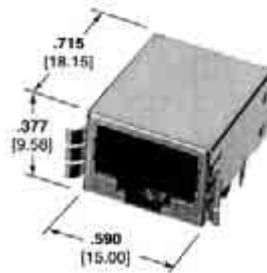

Part Number 1116201-1

| Part Number | Positions/Contacts | LEDs    | Shielded | Performance | Panel Stops | Inverted | Ground Options |
|-------------|--------------------|---------|----------|-------------|-------------|----------|----------------|
| 6116201-1   | 8/8                | Without | No       | Cat 5       | Without     | No       | Without        |
| 6116201-2   | 8/8                | Without | No       | Cat 5       | Without     | No       | Without        |
| 6116202-1   | 8/8                | Without | Yes      | Cat 5       | Without     | No       | PCB            |
| 6116418-1   | 8/8                | Without | Yes      | Cat 5       | Without     | No       | Panel and PCB  |

**Note:** Consult Tyco Electronics Sales Representative for additional Part Numbers and features differences (tail length, LED color, IRR, etc.)

**Bottom Entry, Thru-Hole**

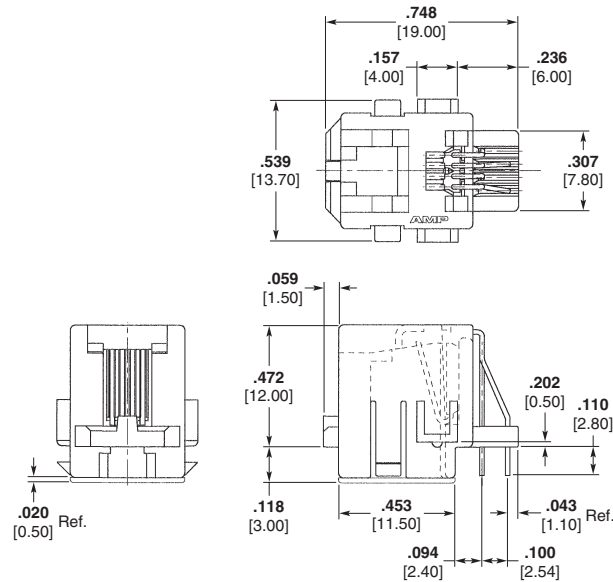

Part Number 216444

| Part Number | Positions/Contacts | LEDs    | Shielded | Performance | Panel Stops | Inverted | Ground Options |
|-------------|--------------------|---------|----------|-------------|-------------|----------|----------------|
| 216444-1    | 4/4                | Without | No       | Cat 3       | Without     | No       | Without        |
| 216446-1    | 6/6                | Without | No       | Cat 3       | Without     | No       | Without        |

**Note:** Consult Tyco Electronics Sales Representative for additional Part Numbers and features differences (tail length, LED color, IRR, etc.)

**Note:** All part numbers are RoHS compliant.

**Single Port Modular Jacks (Continued)**

**Bottom Entry, Surface Mount**

**6-Position**



**Top or Bottom Entry  
Part Number 1-338088-3**

| Part Number | Positions/Contacts | LEDs    | Shielded | Performance | Panel Stops | Inverted | Ground Options |
|-------------|--------------------|---------|----------|-------------|-------------|----------|----------------|
| 100860-1    | 6/6                | Without | No       | Cat 3       | Without     | No       | Without        |
| 1-338088-5  | 8/8                | Without | No       | Cat 3       | Without     | No       | Without        |
| 2-100860-1  | 6/6                | Without | No       | Cat 3       | Without     | No       | Without        |

**Note:** Consult Tyco Electronics Sales Representative for additional Part Numbers and features differences (tail length, LED color, IRR, etc.)

**Shorting  
Unshielded**



| Positions/Contacts | Shorting Configuration             | Tray Packaging Part No. |
|--------------------|------------------------------------|-------------------------|
| 8/8                | 1-4 & 2-5 RJ 48X                   | 5557788-1               |
| 8/8                | 3-5 & 4-6 IBM Token Ring Emulation | 5569972-1               |

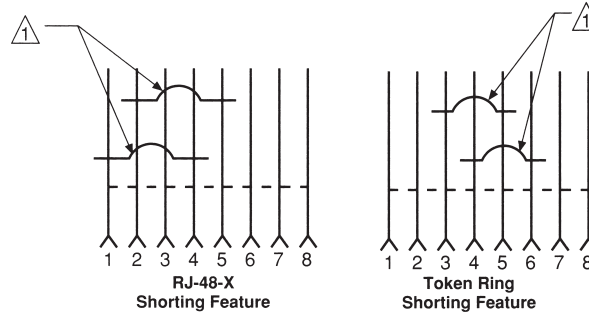

Short is removed by insertion of modular plug.

**Shielded**

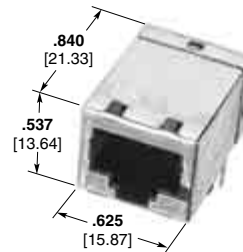

| Positions/Contacts | Shorting Configuration             | Panel Grounds | Tray Packaging Part Numbers |
|--------------------|------------------------------------|---------------|-----------------------------|
| 8/8                | 1-4 & 2-5 RJ 48X                   | —             | 5557789-1                   |
| 8/8                | 1-4 & 2-5 RJ 48X                   | Y             | 5557791-1                   |
| 8/8                | 3-5 & 4-6 IBM Token Ring Emulation | —             | 5569972-1                   |

IBM is a trademark of International Business Machine Corporation.

**Note:** All part numbers are RoHS compliant.

**NOTE:** SHIELDED PRODUCT WITH PANEL GROUNDS ALWAYS CONTAINS PCB GROUNDS