

Single Port Modular Jacks

Product Facts

- Meets or exceeds FCC Part 68 rules and regulations; REA PE-76; and UL 1863, Communication Circuit Accessories
- Meets 1000 volt dielectric requirement Contact to Contact
- Available in both top and side entry (Right-Angle)
- Designed for direct mounting on pc boards
- Designed for ease of soldering and board cleaning
- Available in both shielded and unshielded versions
- Shielded jack available with two grounding paths - pc board and panel
- 20 dB shielding effectiveness from 30 MHz to 400 MHz
- Selectively gold plated contacts for lower cost
- All jacks are UL 94V-0 flame retardant polyester, standard color black, unless specified otherwise
- Listed by Underwriters Laboratories Inc., File No. E81956 
- Certified by Canadian Standards Association, File No. LR 7189A 
- Produced under a Quality Management System Certified to ISO 9001
A copy of the certificate is available upon request



Specifications

Electrical

Current Rating — 1.5 amp max. @ 25°C, derated to 0.2 amp max. @ 70°C ambient

Voltage Rating — 150 volts AC max.

Dielectric Withstanding Voltage — 1000 VAC, RMS, 60 Hz, 1 min. Contact to Contact

Mechanical

PC Board Retention — will not dislodge from pc board when subjected to 1 lb. [4.4N] pull before soldering and 10 lb. [44N] pull after soldering

Durability — 750 mating cycles

Material and Finish

Housing — Through-hole: Polyester (wave solder compatible), UL 94V-0 rated; Surface Mount: Polyphenylene Sulfide, or High Temp Nylon, UL 94V-0 rated

Contact — .014 [0.36] thk. Phosphor bronze; plated .000050 [0.00127] gold in contact area and .000150 [0.00381] tin-lead on solder tails, over .000050 [0.00127] nickel underplate

Technical Documents

Application Specifications

114-02048
114-6040

Product Specifications

108-01163
108-01163-1
108-01163-3
108-01163-4
108-01163-7

Single Port Modular Jacks (Continued)
Side Entry (RA), Thru-Hole

| Part Number | Positions/Contacts | LEDs | Shielded | Performance | Panel Stops | Inverted | Ground Options |
|-------------|--------------------|---------|----------|-------------|-------------|----------|----------------|
| 215875-1 | 4/4 | Without | No | Cat 3 | Without | No | Without |
| 2-215875-1 | 4/4 | Without | No | Cat 3 | Without | No | Without |
| 5520249-2 | 4/4 | Without | No | Cat 3 | With | No | Without |
| 215876-2 | 6/4 | Without | No | Cat 3 | Without | No | Without |
| 5555140-2 | 6/4 | Without | Yes | Cat 3 | With | No | Panel and PCB |
| 5555163-2 | 6/4 | Without | No | Cat 3 | With | No | Without |
| 1-215876-3 | 6/6 | Without | No | Cat 3 | Without | No | Without |
| 215876-1 | 6/6 | Without | No | Cat 3 | N/A | No | Without |
| 5520250-3 | 6/6 | Without | No | Cat 3 | With | No | Without |
| 5555003-1 | 6/6 | Without | No | Cat 3 | With | No | Without |
| 5555140-1 | 6/6 | Without | Yes | Cat 3 | With | No | Panel and PCB |
| 5555154-1 | 6/6 | Without | Yes | Cat 3 | With | No | PCB Ground |
| 5555163-1 | 6/6 | Without | No | Cat 3 | With | No | Without |
| 5555165-1 | 6/6 | Without | No | Cat 3 | Without | No | Without |
| 106066-2 | 8/8 | Without | Yes | Cat 3 | Without | No | Panel and PCB |
| 1116062-2 | 8/8 | Without | Yes | Cat 5 | Without | No | Panel and PCB |
| 1116503-2 | 8/8 | Without | Yes | Cat 5 | Without | No | PCB Ground |
| 6116526-1 | 8/8 | Without | Yes | Cat 5 | Without | No | PCB Ground |
| 1-215877-3 | 8/8 | Without | No | Cat 3 | Without | No | Without |

Note: Consult Tyco Electronics Sales Representative for additional Part Numbers and features differences (tail length, LED color, IRR, etc.)

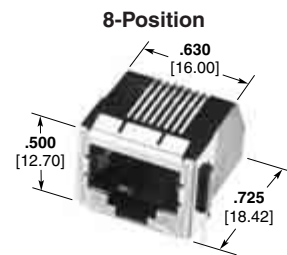
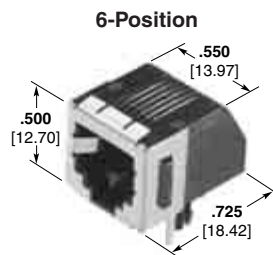
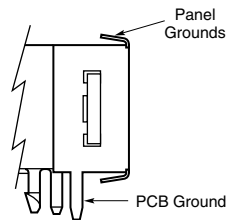
Low Profile, Face Shield

| Part Number | Positions/Contacts | LEDs | Shielded | Performance | Panel Stops | Inverted | Ground Options |
|-------------|--------------------|---------|----------|-------------|-------------|----------|----------------|
| 5555162-1 | 8/8 | Without | No | Cat 3 | With | No | Without |
| 5555164-1 | 8/8 | Without | No | Cat 3 | Without | No | Without |
| 1-5406299-1 | 8/8 | Without | Yes | Cat 5 | Without | No | Panel and PCB |
| 1-1734264-1 | 8/8 | Without | Yes | Cat 3 | Without | No | Panel and PCB |
| 1734579-1 | 8/8 | Without | Yes | Cat 3 | Without | No | PCB Ground |
| 215877-1 | 8/8 | Without | No | Cat 3 | Without | No | Without |
| 2-215877-1 | 8/8 | Without | No | Cat 3 | Without | No | Without |
| 2-215878-1 | 8/8 | Without | No | Cat 3 | Without | No | Without |
| 2-5338556-1 | 8/8 | Without | Yes | Cat 3 | Without | No | Panel and PCB |
| 3-5338556-1 | 8/8 | Without | Yes | Cat 3 | Without | No | Panel and PCB |
| 5406217-1 | 8/8 | Without | Yes | Cat 5 | Without | No | Panel and PCB |
| 5406296-1 | 8/8 | Without | Yes | Cat 5 | Without | No | Panel and PCB |

Note: Consult Tyco Electronics Sales Representative for additional Part Numbers and features differences (tail length, LED color, IRR, etc.)

Note: All part numbers are RoHS compliant.

Single Port Modular Jacks (Continued)

Side Entry (RA), Thru-Hole

Low Profile, Face Shield
(Continued)

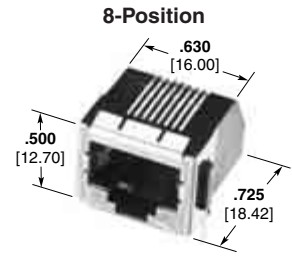
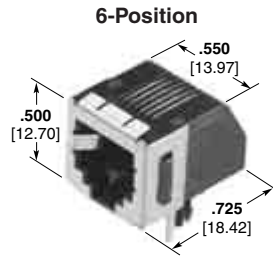

| Part Number | Positions/Contacts | LEDs | Shielded | Performance | Panel Stops | Inverted | Ground Options |
|-------------|--------------------|---------|----------|-------------|-------------|----------|----------------|
| 5406299-1 | 8/8 | Without | Yes | Cat 5 | Without | No | Panel and PCB |
| 1-406525-1 | 8/8 | Without | No | Cat 5 | Without | Yes | Without |
| 1-406541-1 | 8/8 | Without | Yes | Cat 5 | Without | Yes | Panel and PCB |
| 5520243-4 | 8/8 | Without | No | Cat 3 | Without | No | Without |
| 5520251-4 | 8/8 | Without | No | Cat 3 | With | No | Without |
| 5520426-4 | 8/8 | Without | No | Cat 3 | Without | No | Without |
| 5555141-1 | 8/8 | Without | Yes | Cat 3 | Without | No | Panel and PCB |
| 5555153-1 | 8/8 | Without | Yes | Cat 3 | With | No | PCB Ground |
| 5555153-3 | 8/8 | Without | Yes | Cat 3 | With | No | PCB Ground |

Note: Consult Tyco Electronics Sales Representative for additional Part Numbers and features differences (tail length, LED color, IRR, etc.)

Side Entry (RA), Thru-Hole

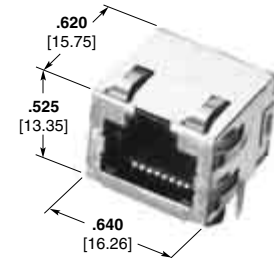

| Part Number | Positions/Contacts | LEDs | Shielded | Performance | Panel Stops | Inverted | Ground Options |
|-------------|--------------------|---------|----------|-------------|-------------|----------|----------------|
| 5555166-1 | 8/8 | Without | No | Cat 3 | With | No | Without |
| 5555167-1 | 8/8 | Without | No | Cat 3 | Without | No | Without |
| 5557785-1 | 8/8 | Without | No | Cat 3 | Without | No | Without |
| 5557789-1 | 8/8 | Without | Yes | Cat 3 | Without | No | PCB Ground |
| 5557791-1 | 8/8 | Without | Yes | Cat 3 | Without | No | Panel and PCB |
| 5558341-1 | 8/8 | Without | No | Cat 5 | Without | No | Without |
| 5558342-1 | 8/8 | Without | Yes | Cat 5 | Without | No | PCB Ground |
| 5558344-1 | 8/8 | Without | Yes | Cat 5 | Without | No | Panel and PCB |
| 5569115-1 | 8/8 | Without | Yes | Cat 3 | With | No | Panel and PCB |
| 5569118-1 | 8/8 | Without | No | Cat 3 | Without | No | Without |
| 6116075-1 | 8/8 | With | Yes | Cat 5 | Without | Yes | PCB Ground |
| 6116173-1 | 8/8 | With | Yes | Cat 5 | Without | Yes | Panel and PCB |
| 6364139-5 | 8/8 | With | No | Cat 5 | Without | Yes | Without |
| 1734509-2 | 8/8 | With | Yes | Cat 3 | Without | No | PCB Ground |
| 5406533-1 | 8/8 | With | No | Cat 5 | Without | Yes | Without |
| 2-406549-1 | 8/8 | With | Yes | Cat 5 | Without | Yes | Panel and PCB |
| 2-406549-4 | 8/8 | With | Yes | Cat 5 | Without | Yes | Panel and PCB |
| 5569564-1 | 8/8 | With | Yes | Cat 3 | Without | No | Panel and PCB |
| 1734542-5 | 10/10 | Without | No | Cat 3 | Without | No | Without |
| 5558065-1 | 10/10 | Without | No | Cat 3 | Without | No | Without |
| 5558067-1 | 10/10 | Without | Yes | Cat 3 | Without | No | PCB Ground |
| 5558070-1 | 10/10 | Without | Yes | Cat 3 | Without | No | Panel and PCB |

Note: Consult Tyco Electronics Sales Representative for additional Part Numbers and features differences (tail length, LED color, IRR, etc.)

Note: All part numbers are RoHS compliant.

Single Port Modular Jacks (Continued)

**Side Entry (RA),
Surface Mount**

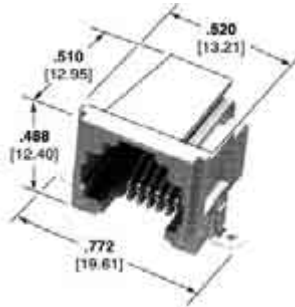

1339212-1

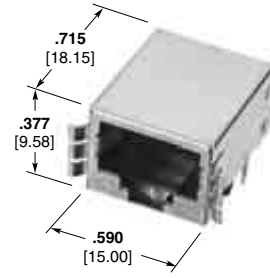

1339212-1

| Part Number | Positions/Contacts | LEDs | Shielded | Performance | Panel Stops | Inverted | Ground Options |
|-------------|--------------------|---------|----------|-------------|-------------|----------|----------------|
| 6339212-1 | 6/6 | Without | Yes | Cat 3 | Without | Yes | Panel and PCB |
| 5406514-2 | 6/6 | Without | No | Cat 3 | Without | Yes | Without |
| 5555077-1 | 6/6 | Without | No | Cat 3 | With | No | Without |
| 6339160-1 | 8/8 | Without | Yes | Cat 3 | Without | Yes | Panel and PCB |
| 5406721-1 | 8/8 | Without | No | Cat 3 | With | Yes | Without |
| 5406721-2 | 8/8 | Without | No | Cat 3 | With | Yes | Without |
| 5558178-1 | 8/8 | Without | Yes | Cat 3 | With | No | PCB Ground |

Note: Consult Tyco Electronics Sales Representative for additional Part Numbers and features differences (tail length, LED color, IRR, etc.)

Top Entry, Thru-Hole

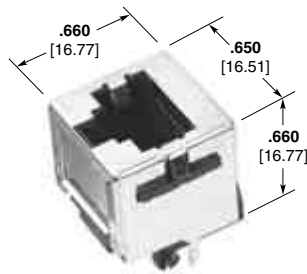

Shielded 557484-1

| Part Number | Positions/Contacts | LEDs | Shielded | Performance | Panel Stops | Inverted | Ground Options |
|-------------|--------------------|---------|----------|-------------|-------------|----------|----------------|
| 5520257-2 | 4/4 | Without | No | Cat 3 | With | No | Without |
| 5406010-2 | 6/2 | Without | No | Cat 3 | Without | No | Without |
| 5520258-2 | 6/4 | Without | No | Cat 3 | With | No | Without |

Note: Consult Tyco Electronics Sales Representative for additional Part Numbers and features differences (tail length, LED color, IRR, etc.)

Note: All part numbers are RoHS compliant.

Single Port Modular Jacks (Continued)

Top Entry, Thru-Hole



| Part Number | Positions/Contacts | LEDs | Shielded | Performance | Panel Stops | Inverted | Ground Options |
|-------------|--------------------|---------|----------|-------------|-------------|----------|----------------|
| 5520425-2 | 6/4 | Without | No | Cat 3 | Without | No | Without |
| 216548-1 | 6/6 | Without | No | Cat 3 | With | No | Without |
| 216564-1 | 6/6 | Without | No | Cat 3 | With | No | Without |
| 5520258-3 | 6/6 | Without | No | Cat 3 | With | No | Without |
| 5520425-3 | 6/6 | Without | No | Cat 3 | Without | No | Without |
| 5554990-1 | 6/6 | Without | No | Cat 3 | With | No | Without |
| 100616-1 | 8/8 | Without | Yes | Cat 3 | With | No | PCB Ground |
| 100616-2 | 8/8 | Without | Yes | Cat 3 | With | No | PCB Ground |
| 6116202-1 | 8/8 | Without | Yes | Cat 5 | Without | No | PCB Ground |
| 216550-1 | 8/8 | Without | No | Cat 3 | With | No | Without |
| 216566-1 | 8/8 | Without | No | Cat 3 | With | No | Without |
| 5520259-4 | 8/8 | Without | No | Cat 3 | With | No | Without |
| 555799-1 | 8/8 | Without | No | Cat 3 | Without | No | Without |
| 5556416-1 | 8/8 | Without | No | Cat 3 | Without | No | Without |
| 5557484-1 | 8/8 | Without | Yes | Cat 3 | With | No | Panel and PCB |
| 5557730-1 | 8/8 | Without | Yes | Cat 3 | With | No | Panel and PCB |
| 5557969-1 | 8/8 | Without | Yes | Cat 3 | With | No | Panel and PCB |
| 5557969-2 | 8/8 | Without | Yes | Cat 3 | With | No | Panel and PCB |

Note: Consult Tyco Electronics Sales Representative for additional Part Numbers and features differences (tail length, LED color, IRR, etc.)

Top Entry, Surface Mount

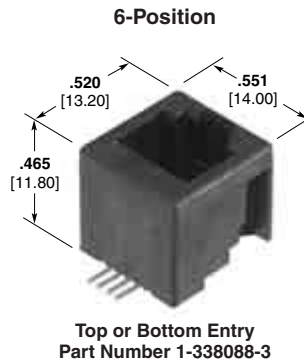

| Part Number | Positions/Contacts | LEDs | Shielded | Performance | Panel Stops | Inverted | Ground Options |
|-------------|--------------------|---------|----------|-------------|-------------|----------|----------------|
| 1-338084-3 | 4/4 | Without | No | Cat 3 | Without | No | Without |
| 1-338086-3 | 6/6 | Without | No | Cat 3 | Without | No | Without |
| 2-338086-3 | 6/6 | Without | No | Cat 3 | Without | No | Without |
| 1-338088-3 | 8/8 | Without | No | Cat 3 | Without | No | Without |
| 2-338088-3 | 8/8 | Without | No | Cat 3 | Without | No | Without |

Note: Consult Tyco Electronics Sales Representative for additional Part Numbers and features differences (tail length, LED color, IRR, etc.)

Note: All part numbers are RoHS compliant.

Single Port Modular Jacks (Continued)

Top Entry, Press Fit

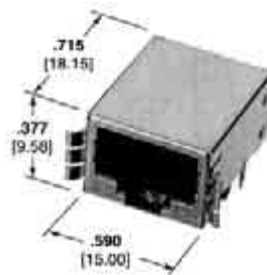

Part Number 1116201-1

| Part Number | Positions/Contacts | LEDs | Shielded | Performance | Panel Stops | Inverted | Ground Options |
|-------------|--------------------|---------|----------|-------------|-------------|----------|----------------|
| 6116201-1 | 8/8 | Without | No | Cat 5 | Without | No | Without |
| 6116201-2 | 8/8 | Without | No | Cat 5 | Without | No | Without |
| 6116202-1 | 8/8 | Without | Yes | Cat 5 | Without | No | PCB |
| 6116418-1 | 8/8 | Without | Yes | Cat 5 | Without | No | Panel and PCB |

Note: Consult Tyco Electronics Sales Representative for additional Part Numbers and features differences (tail length, LED color, IRR, etc.)

Bottom Entry, Thru-Hole



Part Number 216444

| Part Number | Positions/Contacts | LEDs | Shielded | Performance | Panel Stops | Inverted | Ground Options |
|-------------|--------------------|---------|----------|-------------|-------------|----------|----------------|
| 216444-1 | 4/4 | Without | No | Cat 3 | Without | No | Without |
| 216446-1 | 6/6 | Without | No | Cat 3 | Without | No | Without |

Note: Consult Tyco Electronics Sales Representative for additional Part Numbers and features differences (tail length, LED color, IRR, etc.)

Note: All part numbers are RoHS compliant.

Single Port Modular Jacks (Continued)

Bottom Entry, Surface Mount

6-Position



**Top or Bottom Entry
Part Number 1-338088-3**

| Part Number | Positions/Contacts | LEDs | Shielded | Performance | Panel Stops | Inverted | Ground Options |
|-------------|--------------------|---------|----------|-------------|-------------|----------|----------------|
| 100860-1 | 6/6 | Without | No | Cat 3 | Without | No | Without |
| 1-338088-5 | 8/8 | Without | No | Cat 3 | Without | No | Without |
| 2-100860-1 | 6/6 | Without | No | Cat 3 | Without | No | Without |

Note: Consult Tyco Electronics Sales Representative for additional Part Numbers and features differences (tail length, LED color, IRR, etc.)

**Shorting
Unshielded**



| Positions/Contacts | Shorting Configuration | Tray Packaging Part No. |
|--------------------|------------------------------------|-------------------------|
| 8/8 | 1-4 & 2-5 RJ 48X | 5557788-1 |
| 8/8 | 3-5 & 4-6 IBM Token Ring Emulation | 5569972-1 |



1 Short is removed by insertion of modular plug.

Shielded

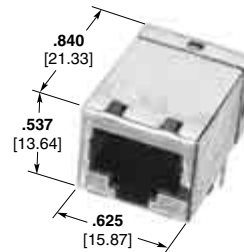

| Positions/Contacts | Shorting Configuration | Panel Grounds | Tray Packaging Part Numbers |
|--------------------|------------------------------------|---------------|-----------------------------|
| 8/8 | 1-4 & 2-5 RJ 48X | — | 5557789-1 |
| 8/8 | 1-4 & 2-5 RJ 48X | Y | 5557791-1 |
| 8/8 | 3-5 & 4-6 IBM Token Ring Emulation | — | 5569972-1 |

IBM is a trademark of International Business Machine Corporation.

Note: All part numbers are RoHS compliant.

NOTE: SHIELDED PRODUCT WITH PANEL GROUNDS ALWAYS CONTAINS PCB GROUNDS