



## Single Port Modular Jacks

### Product Facts

- Meets or exceeds FCC Part 68 rules and regulations; REA PE-76; and UL 1863, Communication Circuit Accessories
- Meets 1000 volt dielectric requirement Contact to Contact
- Available in both top and side entry (Right-Angle)
- Designed for direct mounting on pc boards
- Designed for ease of soldering and board cleaning
- Available in both shielded and unshielded versions
- Shielded jack available with two grounding paths - pc board and panel
- 20 dB shielding effectiveness from 30 MHz to 400 MHz
- Selectively gold plated contacts for lower cost
- All jacks are UL 94V-0 flame retardant polyester, standard color black, unless specified otherwise
- Listed by Underwriters Laboratories Inc., File No. E81956 
- Certified by Canadian Standards Association, File No. LR 7189A 
- Produced under a Quality Management System Certified to ISO 9001  
A copy of the certificate is available upon request

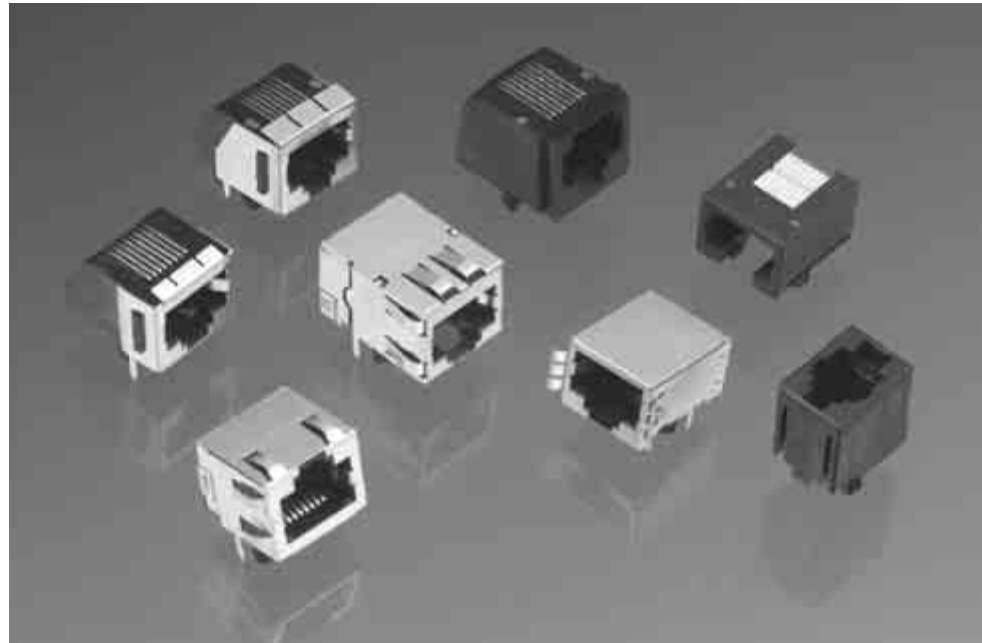

### Specifications

#### Electrical

**Current Rating** — 1.5 amp max. @ 25°C, derated to 0.2 amp max. @ 70°C ambient

**Voltage Rating** — 150 volts AC max.

**Dielectric Withstanding Voltage** — 1000 VAC, RMS, 60 Hz, 1 min. Contact to Contact

#### Mechanical

**PC Board Retention** — will not dislodge from pc board when subjected to 1 lb. [4.4N] pull before soldering and 10 lb. [44N] pull after soldering

**Durability** — 750 mating cycles

### Material and Finish

**Housing** — Through-hole: Polyester (wave solder compatible), UL 94V-0 rated; Surface Mount: Polyphenylene Sulfide, or High Temp Nylon, UL 94V-0 rated

**Contact** — .014 [0.36] thk. Phosphor bronze; plated .000050 [0.00127] gold in contact area and .000150 [0.00381] tin-lead on solder tails, over .000050 [0.00127] nickel underplate

### Technical Documents

**Application Specifications**  
114-02048  
114-6040

**Product Specifications**  
108-01163  
108-01163-1  
108-01163-3  
108-01163-4  
108-01163-7

**Single Port Modular Jacks (Continued)**

**Side Entry (RA), Thru-Hole**



Part Number	Positions/Contacts	LEDs	Shielded	Performance	Panel Stops	Inverted	Ground Options
215875-1	4/4	Without	No	Cat 3	Without	No	Without
2-215875-1	4/4	Without	No	Cat 3	Without	No	Without
5520249-2	4/4	Without	No	Cat 3	With	No	Without
215876-2	6/4	Without	No	Cat 3	Without	No	Without
5555140-2	6/4	Without	Yes	Cat 3	With	No	Panel and PCB
5555163-2	6/4	Without	No	Cat 3	With	No	Without
1-215876-3	6/6	Without	No	Cat 3	Without	No	Without
215876-1	6/6	Without	No	Cat 3	N/A	No	Without
5520250-3	6/6	Without	No	Cat 3	With	No	Without
5555003-1	6/6	Without	No	Cat 3	With	No	Without
5555140-1	6/6	Without	Yes	Cat 3	With	No	Panel and PCB
5555154-1	6/6	Without	Yes	Cat 3	With	No	PCB Ground
5555163-1	6/6	Without	No	Cat 3	With	No	Without
5555165-1	6/6	Without	No	Cat 3	Without	No	Without
106066-2	8/8	Without	Yes	Cat 3	Without	No	Panel and PCB
1116062-2	8/8	Without	Yes	Cat 5	Without	No	Panel and PCB
1116503-2	8/8	Without	Yes	Cat 5	Without	No	PCB Ground
6116526-1	8/8	Without	Yes	Cat 5	Without	No	PCB Ground
1-215877-3	8/8	Without	No	Cat 3	Without	No	Without

**Note:** Consult Tyco Electronics Sales Representative for additional Part Numbers and features differences (tail length, LED color, IRR, etc.)

**Low Profile, Face Shield**

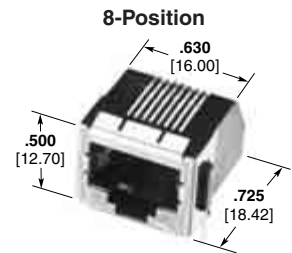
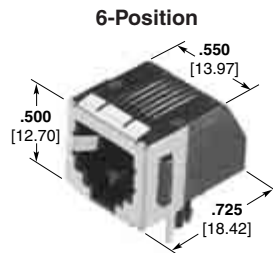
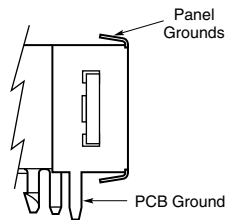

Part Number	Positions/Contacts	LEDs	Shielded	Performance	Panel Stops	Inverted	Ground Options
5555162-1	8/8	Without	No	Cat 3	With	No	Without
5555164-1	8/8	Without	No	Cat 3	Without	No	Without
1-5406299-1	8/8	Without	Yes	Cat 5	Without	No	Panel and PCB
1-1734264-1	8/8	Without	Yes	Cat 3	Without	No	Panel and PCB
1734579-1	8/8	Without	Yes	Cat 3	Without	No	PCB Ground
215877-1	8/8	Without	No	Cat 3	Without	No	Without
2-215877-1	8/8	Without	No	Cat 3	Without	No	Without
2-215878-1	8/8	Without	No	Cat 3	Without	No	Without
2-5338556-1	8/8	Without	Yes	Cat 3	Without	No	Panel and PCB
3-5338556-1	8/8	Without	Yes	Cat 3	Without	No	Panel and PCB
5406217-1	8/8	Without	Yes	Cat 5	Without	No	Panel and PCB
5406296-1	8/8	Without	Yes	Cat 5	Without	No	Panel and PCB

**Note:** Consult Tyco Electronics Sales Representative for additional Part Numbers and features differences (tail length, LED color, IRR, etc.)

**Note:** All part numbers are RoHS compliant.

**Single Port Modular Jacks (Continued)**

**Side Entry (RA), Thru-Hole**

**Low Profile, Face Shield**  
(Continued)

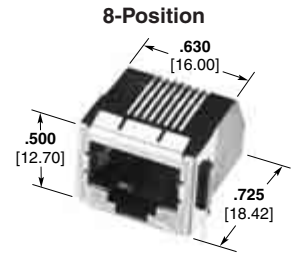
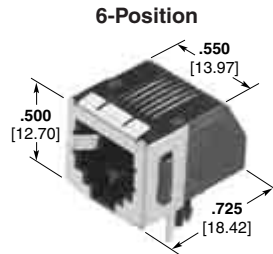
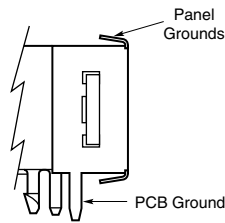

Part Number	Positions/Contacts	LEDs	Shielded	Performance	Panel Stops	Inverted	Ground Options
5406299-1	8/8	Without	Yes	Cat 5	Without	No	Panel and PCB
1-406525-1	8/8	Without	No	Cat 5	Without	Yes	Without
1-406541-1	8/8	Without	Yes	Cat 5	Without	Yes	Panel and PCB
5520243-4	8/8	Without	No	Cat 3	Without	No	Without
5520251-4	8/8	Without	No	Cat 3	With	No	Without
5520426-4	8/8	Without	No	Cat 3	Without	No	Without
5555141-1	8/8	Without	Yes	Cat 3	Without	No	Panel and PCB
5555153-1	8/8	Without	Yes	Cat 3	With	No	PCB Ground
5555153-3	8/8	Without	Yes	Cat 3	With	No	PCB Ground

**Note:** Consult Tyco Electronics Sales Representative for additional Part Numbers and features differences (tail length, LED color, IRR, etc.)

**Side Entry (RA), Thru-Hole**

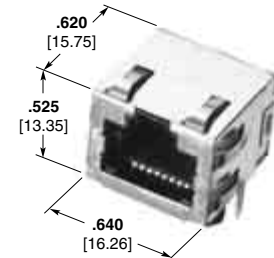
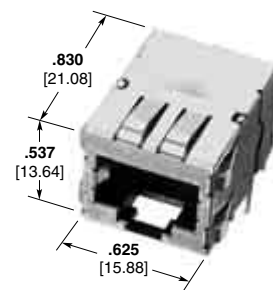
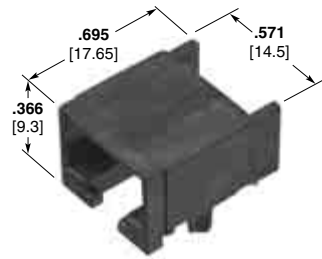

Part Number	Positions/Contacts	LEDs	Shielded	Performance	Panel Stops	Inverted	Ground Options
5555166-1	8/8	Without	No	Cat 3	With	No	Without
5555167-1	8/8	Without	No	Cat 3	Without	No	Without
5557785-1	8/8	Without	No	Cat 3	Without	No	Without
5557789-1	8/8	Without	Yes	Cat 3	Without	No	PCB Ground
5557791-1	8/8	Without	Yes	Cat 3	Without	No	Panel and PCB
5558341-1	8/8	Without	No	Cat 5	Without	No	Without
5558342-1	8/8	Without	Yes	Cat 5	Without	No	PCB Ground
5558344-1	8/8	Without	Yes	Cat 5	Without	No	Panel and PCB
5569115-1	8/8	Without	Yes	Cat 3	With	No	Panel and PCB
5569118-1	8/8	Without	No	Cat 3	Without	No	Without
6116075-1	8/8	With	Yes	Cat 5	Without	Yes	PCB Ground
6116173-1	8/8	With	Yes	Cat 5	Without	Yes	Panel and PCB
6364139-5	8/8	With	No	Cat 5	Without	Yes	Without
1734509-2	8/8	With	Yes	Cat 3	Without	No	PCB Ground
5406533-1	8/8	With	No	Cat 5	Without	Yes	Without
2-406549-1	8/8	With	Yes	Cat 5	Without	Yes	Panel and PCB
2-406549-4	8/8	With	Yes	Cat 5	Without	Yes	Panel and PCB
5569564-1	8/8	With	Yes	Cat 3	Without	No	Panel and PCB
1734542-5	10/10	Without	No	Cat 3	Without	No	Without
5558065-1	10/10	Without	No	Cat 3	Without	No	Without
5558067-1	10/10	Without	Yes	Cat 3	Without	No	PCB Ground
5558070-1	10/10	Without	Yes	Cat 3	Without	No	Panel and PCB

**Note:** Consult Tyco Electronics Sales Representative for additional Part Numbers and features differences (tail length, LED color, IRR, etc.)

**Note:** All part numbers are RoHS compliant.

**Single Port Modular Jacks (Continued)**

**Side Entry (RA),  
Surface Mount**

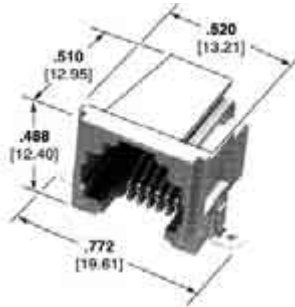

1339212-1

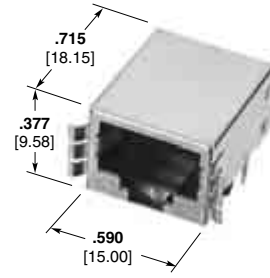

1339212-1

Part Number	Positions/Contacts	LEDs	Shielded	Performance	Panel Stops	Inverted	Ground Options
6339212-1	6/6	Without	Yes	Cat 3	Without	Yes	Panel and PCB
5406514-2	6/6	Without	No	Cat 3	Without	Yes	Without
5555077-1	6/6	Without	No	Cat 3	With	No	Without
6339160-1	8/8	Without	Yes	Cat 3	Without	Yes	Panel and PCB
5406721-1	8/8	Without	No	Cat 3	With	Yes	Without
5406721-2	8/8	Without	No	Cat 3	With	Yes	Without
5558178-1	8/8	Without	Yes	Cat 3	With	No	PCB Ground

**Note:** Consult Tyco Electronics Sales Representative for additional Part Numbers and features differences (tail length, LED color, IRR, etc.)

**Top Entry, Thru-Hole**

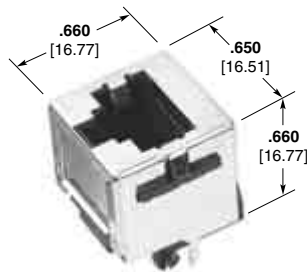

Shielded 557484-1

Part Number	Positions/Contacts	LEDs	Shielded	Performance	Panel Stops	Inverted	Ground Options
5520257-2	4/4	Without	No	Cat 3	With	No	Without
5406010-2	6/2	Without	No	Cat 3	Without	No	Without
5520258-2	6/4	Without	No	Cat 3	With	No	Without

**Note:** Consult Tyco Electronics Sales Representative for additional Part Numbers and features differences (tail length, LED color, IRR, etc.)

**Note:** All part numbers are RoHS compliant.

**Single Port Modular Jacks (Continued)**

**Top Entry, Thru-Hole**



Part Number	Positions/Contacts	LEDs	Shielded	Performance	Panel Stops	Inverted	Ground Options
5520425-2	6/4	Without	No	Cat 3	Without	No	Without
216548-1	6/6	Without	No	Cat 3	With	No	Without
216564-1	6/6	Without	No	Cat 3	With	No	Without
5520258-3	6/6	Without	No	Cat 3	With	No	Without
5520425-3	6/6	Without	No	Cat 3	Without	No	Without
5554990-1	6/6	Without	No	Cat 3	With	No	Without
100616-1	8/8	Without	Yes	Cat 3	With	No	PCB Ground
100616-2	8/8	Without	Yes	Cat 3	With	No	PCB Ground
6116202-1	8/8	Without	Yes	Cat 5	Without	No	PCB Ground
216550-1	8/8	Without	No	Cat 3	With	No	Without
216566-1	8/8	Without	No	Cat 3	With	No	Without
5520259-4	8/8	Without	No	Cat 3	With	No	Without
555799-1	8/8	Without	No	Cat 3	Without	No	Without
5556416-1	8/8	Without	No	Cat 3	Without	No	Without
5557484-1	8/8	Without	Yes	Cat 3	With	No	Panel and PCB
5557730-1	8/8	Without	Yes	Cat 3	With	No	Panel and PCB
5557969-1	8/8	Without	Yes	Cat 3	With	No	Panel and PCB
5557969-2	8/8	Without	Yes	Cat 3	With	No	Panel and PCB

**Note:** Consult Tyco Electronics Sales Representative for additional Part Numbers and features differences (tail length, LED color, IRR, etc.)

**Top Entry, Surface Mount**

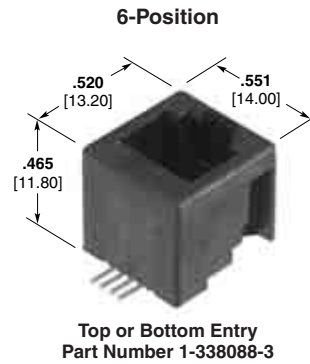

Part Number	Positions/Contacts	LEDs	Shielded	Performance	Panel Stops	Inverted	Ground Options
1-338084-3	4/4	Without	No	Cat 3	Without	No	Without
1-338086-3	6/6	Without	No	Cat 3	Without	No	Without
2-338086-3	6/6	Without	No	Cat 3	Without	No	Without
1-338088-3	8/8	Without	No	Cat 3	Without	No	Without
2-338088-3	8/8	Without	No	Cat 3	Without	No	Without

**Note:** Consult Tyco Electronics Sales Representative for additional Part Numbers and features differences (tail length, LED color, IRR, etc.)

**Note:** All part numbers are RoHS compliant.

**Single Port Modular Jacks (Continued)**

**Top Entry, Press Fit**

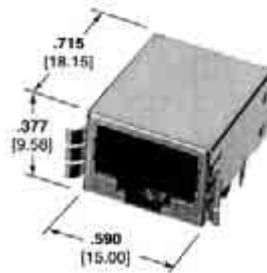

Part Number 1116201-1

Part Number	Positions/Contacts	LEDs	Shielded	Performance	Panel Stops	Inverted	Ground Options
6116201-1	8/8	Without	No	Cat 5	Without	No	Without
6116201-2	8/8	Without	No	Cat 5	Without	No	Without
6116202-1	8/8	Without	Yes	Cat 5	Without	No	PCB
6116418-1	8/8	Without	Yes	Cat 5	Without	No	Panel and PCB

**Note:** Consult Tyco Electronics Sales Representative for additional Part Numbers and features differences (tail length, LED color, IRR, etc.)

**Bottom Entry, Thru-Hole**

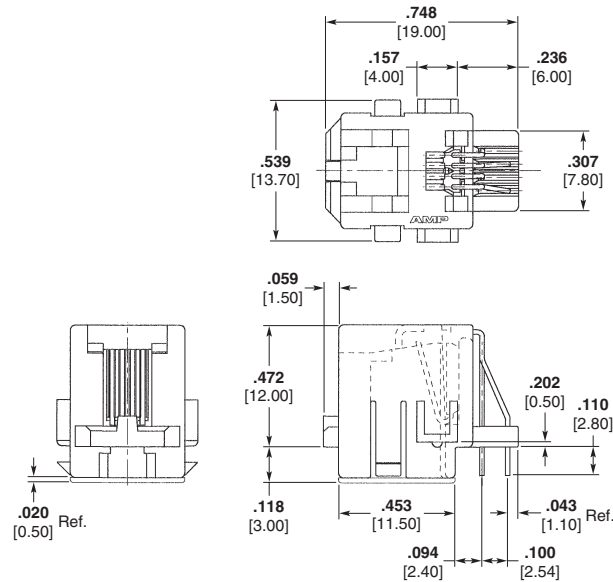

Part Number 216444

Part Number	Positions/Contacts	LEDs	Shielded	Performance	Panel Stops	Inverted	Ground Options
216444-1	4/4	Without	No	Cat 3	Without	No	Without
216446-1	6/6	Without	No	Cat 3	Without	No	Without

**Note:** Consult Tyco Electronics Sales Representative for additional Part Numbers and features differences (tail length, LED color, IRR, etc.)

**Note:** All part numbers are RoHS compliant.

**Single Port Modular Jacks (Continued)**

**Bottom Entry, Surface Mount**

**6-Position**



**Top or Bottom Entry  
Part Number 1-338088-3**

Part Number	Positions/Contacts	LEDs	Shielded	Performance	Panel Stops	Inverted	Ground Options
100860-1	6/6	Without	No	Cat 3	Without	No	Without
1-338088-5	8/8	Without	No	Cat 3	Without	No	Without
2-100860-1	6/6	Without	No	Cat 3	Without	No	Without

**Note:** Consult Tyco Electronics Sales Representative for additional Part Numbers and features differences (tail length, LED color, IRR, etc.)

**Shorting  
Unshielded**



Positions/Contacts	Shorting Configuration	Tray Packaging Part No.
8/8	1-4 & 2-5 RJ 48X	5557788-1
8/8	3-5 & 4-6 IBM Token Ring Emulation	5569972-1

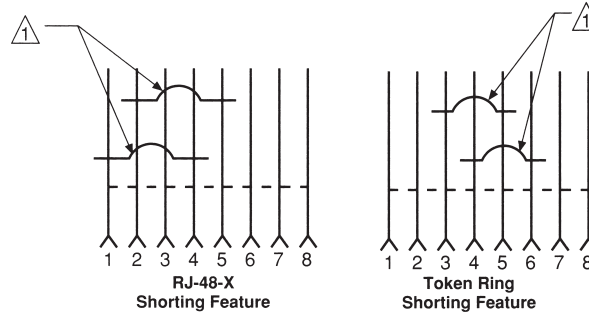

Short is removed by insertion of modular plug.

**Shielded**

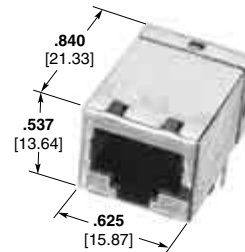

Positions/Contacts	Shorting Configuration	Panel Grounds	Tray Packaging Part Numbers
8/8	1-4 & 2-5 RJ 48X	—	5557789-1
8/8	1-4 & 2-5 RJ 48X	Y	5557791-1
8/8	3-5 & 4-6 IBM Token Ring Emulation	—	5569972-1

IBM is a trademark of International Business Machine Corporation.

**Note:** All part numbers are RoHS compliant.

**NOTE:** SHIELDED PRODUCT WITH PANEL GROUNDS ALWAYS CONTAINS PCB GROUNDS