

Tous droits strictement réservés. Reproduction ou communication à des tiers interdite sous quelque forme que ce soit sans autorisation écrite du propriétaire. Propriété de FCI. Droits de reproduction FCI.

All rights strictly reserved. Reproduction or issue to third parties in any form whatsoever is not permitted without written authority from the proprietor. Property of FCI. Copyright FCI.

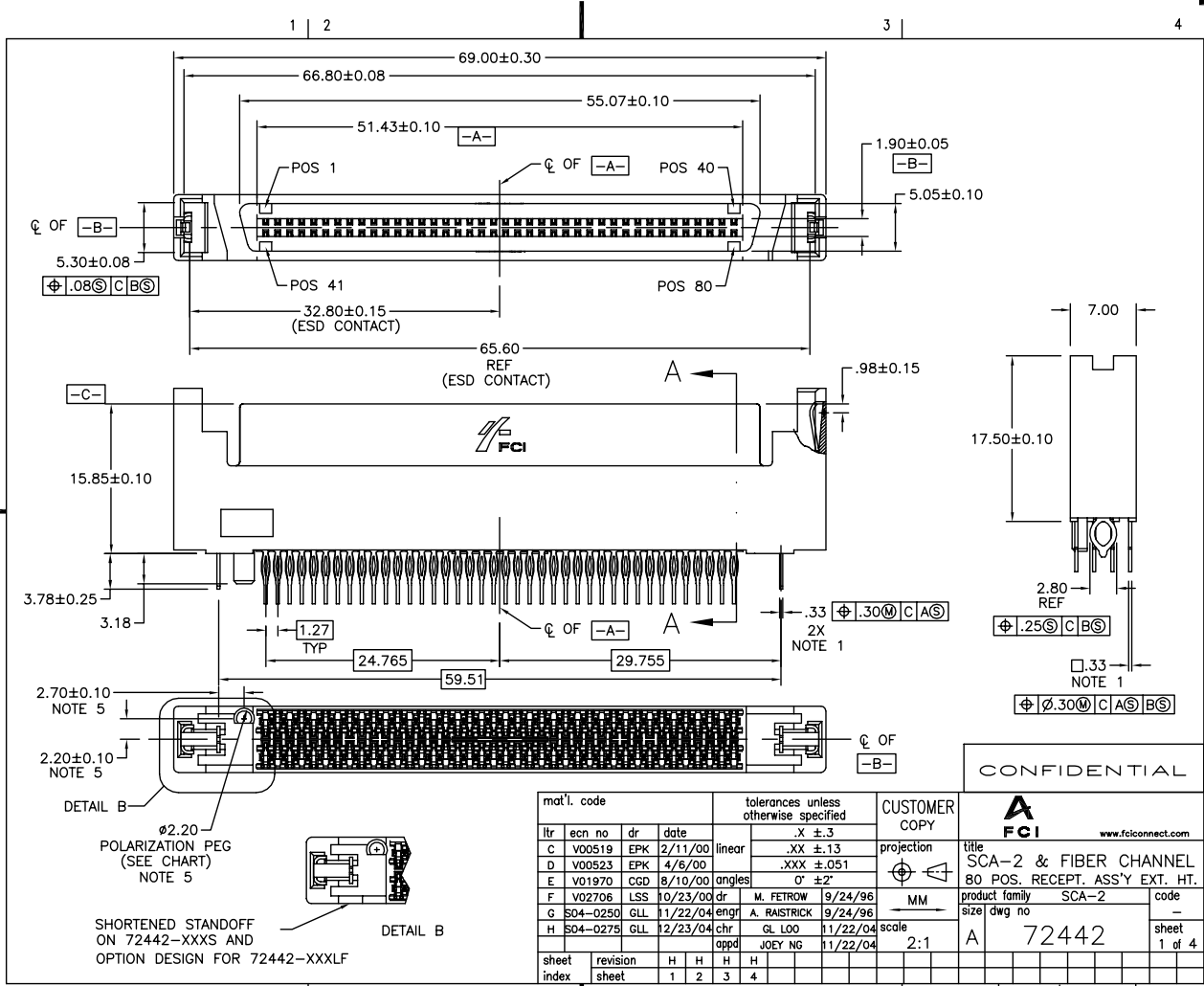

CONFIDENTIAL

mat'l. code		tolerances unless otherwise specified				CUSTOMER COPY	
ltr	ecn no	dr	date	linear	.X ±.3	projection	
C	V00519	EPK	2/11/00		.XX ±.13		
D	V00523	EPK	4/6/00		.XXX ±.051		
E	V01970	CGD	8/10/00	angles	0' ±2'		
F	V02706	LSS	10/23/00	dr	M. FETROW 9/24/96	MM	
G	S04-0250	GLL	11/22/04	enfr	A. RAISTRICK 9/24/96		
H	S04-0275	GLL	12/23/04	chr	GL LOO 11/22/04	scale	2:1
				appd	JOEY NG 11/22/04		
sheet index	revision sheet	H	H	H	H		
		1	2	3	4		

FCI www.fciconnect.com

title SCA-2 & FIBER CHANNEL
80 POS. RECEPT. ASS'Y EXT. HT.

product family SCA-2 code -
size dwg no - sheet 1 of 4

72442

cage code 22526

Ø2.20
POLARIZATION PEG
(SEE CHART)
NOTE 5

SHORTENED STANDOFF
ON 72442-XXXS AND
OPTION DESIGN FOR 72442-XXXLF

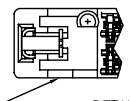

DETAIL B

ACAD

PDM: Rev:H

STATUS: Released

Printed: May 26, 2010

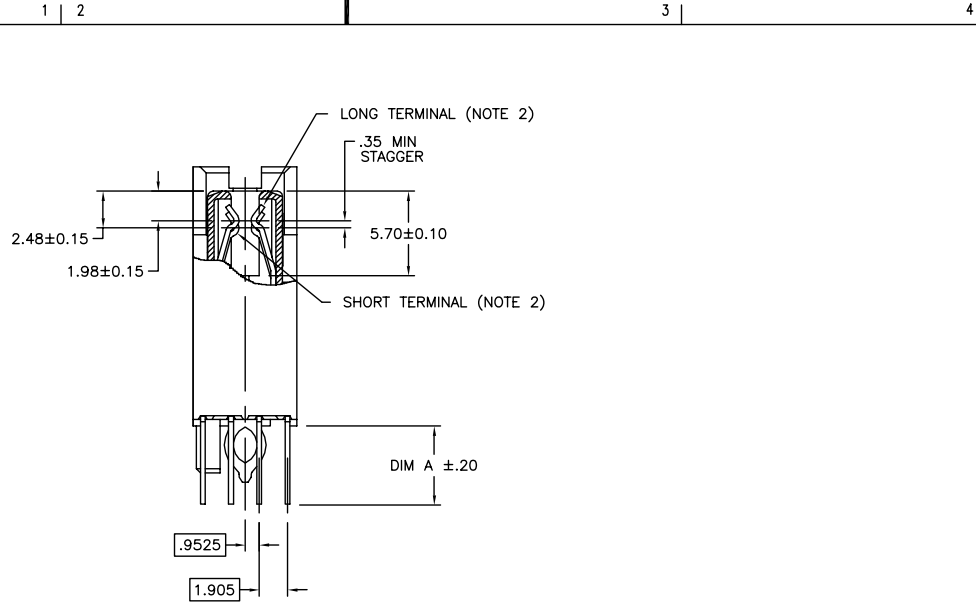

Tous droits strictement réservés. Reproduction ou communication à des tiers interdite sous quelque forme que ce soit sans autorisation écrite du propriétaire. Propriété de c FCI. Droits de reproduction FCI.

All rights strictly reserved. Reproduction or issue to third parties in any form whatsoever is not permitted without written authority from the proprietor. Property of FCI. Copyright FCI.



SECTION A-A

CONFIDENTIAL

mat'l. code				tolerances unless otherwise specified				CUSTOMER COPY		 www.fciconnect.com	
ltr	ecn no	dr	date	linear	.X ±.3	projection			title		
H					.XX ±.13				SCA-2 & FIBER CHANNEL		
				angles	.XXX ±.051				80 POS. RECEPT. ASS'Y EXT. HT.		
				dr	Ø ±.2				product family		
				enfr	M. FETROW 9/24/96	MM			SCA-2		
				chr	A. RAISTRICK 9/24/96	scale			size		
				appd	GL LOO 11/22/04	2:1			72442		
					JOEY NG 11/22/04				sheet		
sheet index	revision sheet								2 of 4		

cage code 22526

ACAD

PDM: Rev:H

STATUS: Released

Printed: May 26, 2010

Tous droits strictement réservés. Reproduction ou communication à des tiers interdite sous quelque forme que ce soit sans autorisation écrite du propriétaire. Propriété de c FCI. Droits de reproduction FCI.

All rights strictly reserved. Reproduction or issue to third parties in any form whatsoever is not permitted without written authority from the proprietor. Property of FCI. Copyright FCI.

PRODUCT NO.	DIM A	POLARIZATION PEG	PLATING	RECOMMENDED P.C. BOARD THICKNESS	PRODUCT NO.	PLATING
72442-001	3.79	YES	NOTE 4	2.36mm (0.093") AND 3.18mm (0.125")	72442-101	NOTE 6
-001S					-101S	
-002	3.79	NO			-102	
-002S					-102S	
-003	4.60	YES			-103	
-003S					-103S	
-004	4.60	NO		-104		
72442-004S				72442-104S		

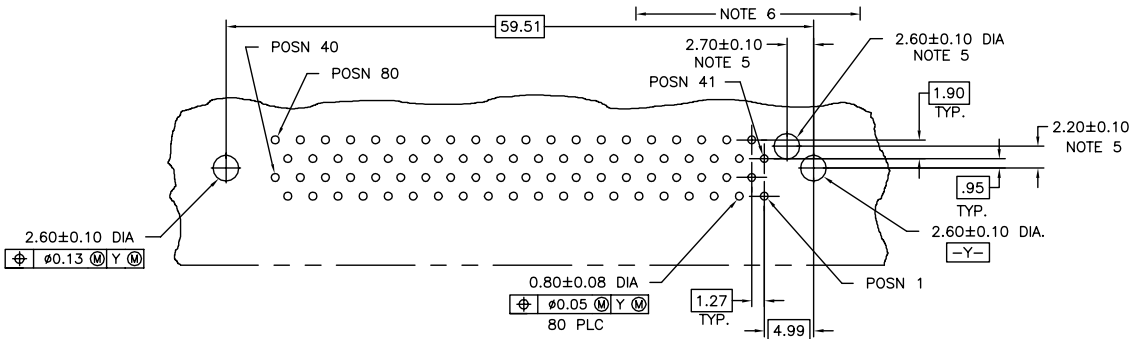

NOTES :

- TRUE POSITION NOTES APPLY AT TERMINAL TIP.
- CONTACTS IN POSITIONS 2 THRU 35, 44 AND 47 THRU 74 ARE SHORT TERMINALS. CONTACTS IN POSITIONS 1, 36 THRU 43, 45, 46, AND 75 THRU 80 ARE LONG TERMINALS.
- RAW MATERIALS:
HOUSING: HTIN, UL94V-0, COLOR: BLACK
CONTACTS: PHOSPHOR-BRONZE
- CONTACT PLATING: 30u" (0.76um) MIN. GXT PLATING OVER 50u" (1.27um) NICKLE MIN. UNDERPLATE IN CONTACT AREA. 20u" (0.5um) MIN-60u" (1.5um)MAX TIN-LEAD PLATING OVER 50u" (1.27um) MIN. NICKLE UNDERPLATE IN P.C. BOARD LEG AREA. 50u" (1.27um) MIN. NICKLE UNDERPLATE OVER REMAINING AREA.
- DIMENSIONS DO NOT APPLY TO CONNECTOR STYLES WITHOUT POLARIZATION PEG. (SEE CHART)
- CONTACT PLATING: 30u" (0.76um) MIN. GOLD PLATING OVER 50u" (1.27um) NICKLE MIN. UNDERPLATE IN CONTACT AREA. 20u" (0.5um) MIN-60u" (1.5um)MAX TIN-LEAD PLATING OVER 50u" (1.27um) MIN. NICKLE UNDERPLATE IN P.C. BOARD LEG AREA. 50u" (1.27um) MIN. NICKLE UNDERPLATE OVER REMAINING AREA.
- PART NUMBERS WITH SUFFIX "S" ARE MANUFACTURED WITH BRIGHT FINISH TIN-LEAD PLATING IN P.C. BOARD LEG AREA.

CONFIDENTIAL

mat'l. code				tolerances unless otherwise specified		CUSTOMER COPY		FCI www.fciconnect.com	
ltr	ecn no	dr	date	linear	.X ±.3	projection	title		
H					.XX ±.13	MM	SCA-2 & FIBER CHANNEL		
				angles	.XXX ±.051		80 POS. RECEPT. ASS'Y EXT. HT.		
				dr	σ ±.2		product family SCA-2		
				enfr	M. FETROW 9/24/96		size dwg no		
				chr	A. RAISTRICK 9/24/96		72442		
				appd	GL LOO 11/22/04	scale	3 of 4		
					JOEY NG 11/22/04	2:1			
sheet index	revision sheet						cage code 22526		

ACAD

Tous droits strictement réservés. Reproduction ou communication à des tiers
 interdite sous quelque forme que ce soit sans autorisation écrite du propriétaire.
 Property of FCI. Copyright FCI.

All rights strictly reserved. Reproduction or issue to third parties in any
 form whatever is not permitted without written authority from the proprietor.
 Property of FCI. Copyright FCI.



PRODUCT NO.	DIM A	POLARIZATION PEG	PLATING	RECOMMENDED P.C. BOARD THICKNESS	PRODUCT NO.	PLATING
72442-001LF	3.79	YES	NOTE 9	2.36mm (0.093") AND 3.18mm (0.125")	72442-201LF	NOTE 8
-002LF	3.79	NO				
-003LF	4.60	YES				
72442-004LF	4.60	NO				

NOTE 8

NOTES :

- ⑧ CONTACT PLATING: 30u" (0.76um) GOLD PLATING OVER 50u" (1.27um) NICKLE UNDERPLATE IN CONTACT AREA. 20u" (0.5um) - 60u"(1.5um) TIN PLATING OVER 50u" (1.27um) -100u" (2.54um) NICKEL UNDERPLATE IN P.C. BOARD LEG AREA. 50u" (1.27um) NICKEL UNDERPLATE OVER REMAINING AREA.
- ⑨ CONTACT PLATING: 30u" (0.76um) GXT PLATING OVER 50u" (1.27um) NICKLE UNDERPLATE IN CONTACT AREA. 20u" (0.5um) - 60u"(1.5um) TIN PLATING OVER 50u" (1.27um) -100u" (2.54um) NICKEL UNDERPLATE IN P.C. BOARD LEG AREA. 50u" (1.27um) NICKEL UNDERPLATE OVER REMAINING AREA.
- ⑩ THE HOUSING WILL WITHSTAND EXPOSURE TO 260° C PEAK TEMPERATURE FOR 10 SECONDS IN A CONVECTION, INFRA RED VAPOR PHASE REFLOW OVEN.
- ⑪ THIS PRODUCT MEETS EUROPEAN UNION DIRECTIVES AND OTHER COUNTRY REGULATIONS AS DESCRIBED IN GS-22-008.
- 12 PART NUMBERS ENDING IN "LF" MEANS FOR NOTE 11 LEAD FREE IDENTIFICATION.

CONFIDENTIAL

mat'l. code		tolerances unless otherwise specified		CUSTOMER COPY		 www.fciconnect.com	
ltr	ecn no	dr	date	linear	.X ±.3	projection	title
H					.XX ±.13		SCA-2 & FIBER CHANNEL
				angles	.XXX ±.051		80 POS. RECEPT. ASS'Y EXT. HT.
				dr	σ ±.2	MM	product family SCA-2
				enfr	M. FETROW 9/24/96	scale	code -
				chr	A. RAISTRICK 9/24/96	2:1	size dwg no
				appd	GL LOO 11/22/04	A	72442
					JOEY NG 11/22/04		sheet 4 of 4
sheet index	revision sheet						

cage code 22526

ACAD

PDM: Rev:H

STATUS: Released

Printed: May 26, 2010