

NO. OF CONTACTS : 40,60,68,80,100,120  
CRITERION PIN

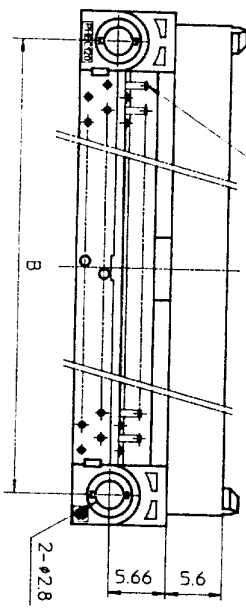

NO. OF CONTACTS : 30,34,50

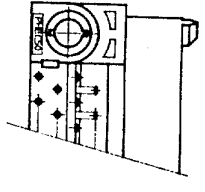

DRAWING NO.  
JSC 90736

SCREW NUT  
M2.6

PHEC\_\_P-R212

PHEC\_\_P-R211

MOUNTING LATCH

RECOMMENDED PC BOARD  
THICKNESS : 1.6 ± 0.2  
HOLE PATTERN (COMPONENT SIDE)

NO. OF CONTACTS : 40,60,68,80,100,120

n : NO. OF CONTACTS

NO. OF CONTACTS : 30,34,50

TOLERANCES  
UNLESS OTHERWISE SPECIFIED : ±0.3

NOTE  
THROUGH-HOLES FOR MOUNTING LATCHES ALSO SHOULD BE PLATED.

CAT. NO.	NO. OF CONTACTS (MATING SIDE)	DIMENSIONS				
		A	B	C	D	E
PHEC30P-R21	15/ROW X 2 ROWS	32.67	26.67	30.3	20.42	17.78
PHEC34P-R21	17/ROW X 2 ROWS	35.21	29.21	32.84	22.96	20.32
PHEC40P-R21	20/ROW X 2 ROWS	39.02	33.02	36.65	26.77	24.13
PHEC50P-R21	25/ROW X 2 ROWS	45.37	39.37	43	33.12	30.48
PHEC60P-R21	30/ROW X 2 ROWS	51.72	45.72	49.35	39.47	36.83
PHEC68P-R21	34/ROW X 2 ROWS	56.8	50.8	54.43	44.55	41.91
PHEC80P-R21	40/ROW X 2 ROWS	64.42	58.42	62.05	52.17	49.53
PHEC100P-R21	50/ROW X 2 ROWS	77.12	71.12	74.75	64.87	62.23
PHEC120P-R21	60/ROW X 2 ROWS	89.82	83.82	87.45	77.57	74.93

MATERIAL : NYLON RESIN GLASS REINFORCED (UL94V-0)  
BODY : BLACK  
LOCATOR : PBT RESIN GLASS REINFORCED (UL94V-0)  
COLOR : BLACK

CONTACT : COPPER ALLOY  
MOUNTING LATCH : PHOSPHOR BRONZE  
SCREW NUT : STEEL  
NICKEL PLATED

CONTACT PLATING TABLE  
(THICKNESS : μm)

CONTACT AREA	REMAINDER
GOLD 0.25 MIN. OVER NICKEL 3Z	SOLDER OVER NICKEL

REV	DATE	DESCRIPTION	CKD	SCALE	DIM. IN	MATERIAL	DESIGNED	DRAWN	CHECKED	APPROVED	DATE	CAT. NO.	DRAWING NO.	REV
92	8-14	30,34,50,68 POSITIONS ADDED. LOCATOR MATERIAL ADDED.										PHEC__P-R21	JSC 90736	3
2	6-7	EC 7866												
1	4-20	EC 7837												

PRINTED CIRCUIT CONNECTOR

CAT. NO. PHEC\_\_P-R21

DRAWING NO. JSC 90736

REV 3

APPROVED *J. Ogasawara*

DATE Mar. 8, 1990

**BURNDY**  
JAPAN Ltd.

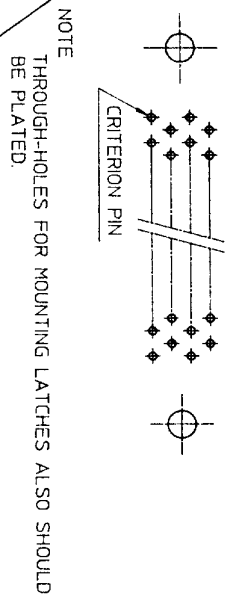
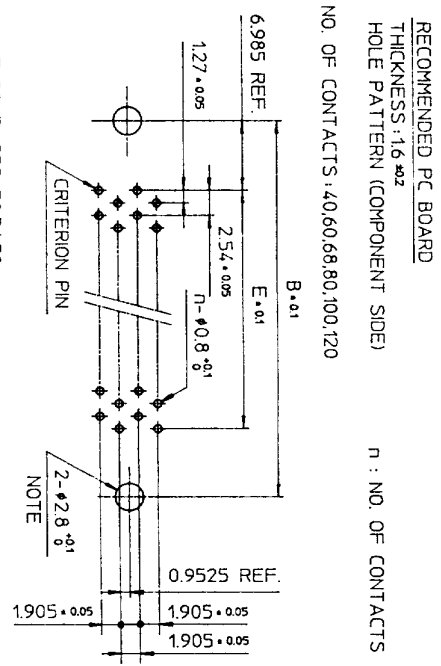
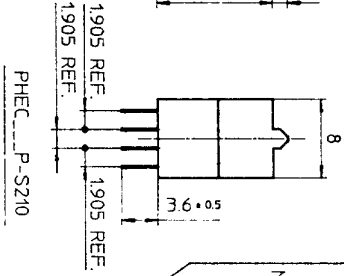
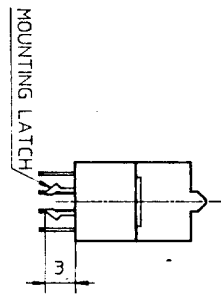
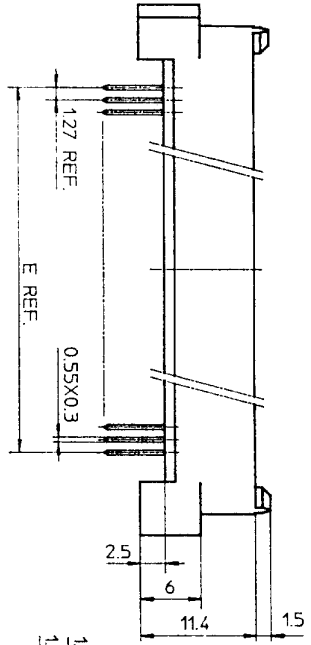
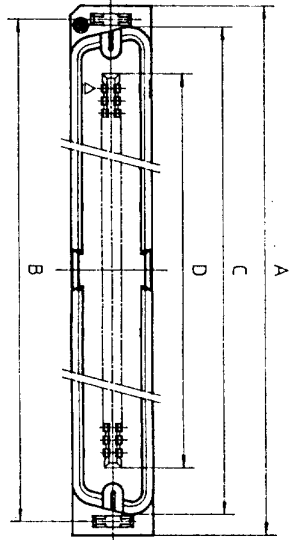

TOLERANCES UNLESS OTHERWISE SPECIFIED: ±0.3

NO. OF CONTACTS: 40,60,68,80,100,120

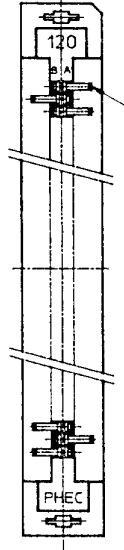

NO. OF CONTACTS: 30,34,50

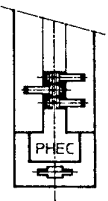

MATERIAL

INSULATOR : NYLON RESIN GLASS REINFORCED (UL94V-0)  
 COLOR : BLACK  
 CONTACT : COPPER ALLOY  
 MOUNTING LATCH : PHOSPHOR BRONZE  
 SOLDER PLATED

CAT. NO.	NO. OF CONTACTS (MATING SIDE)	DIMENSIONS				
		A	B	C	D	E
PHEC30P-S21L	15/ROW X 2 ROWS	34.55	31.75	30.3	20.42	17.78
PHEC34P-S21L	17/ROW X 2 ROWS	37.09	34.29	32.84	22.96	20.32
PHEC40P-S21L	20/ROW X 2 ROWS	40.9	38.1	36.65	26.77	24.13
PHEC50P-S21L	25/ROW X 2 ROWS	47.25	44.45	4.3	33.12	30.48
PHEC60P-S21L	30/ROW X 2 ROWS	53.6	50.8	49.35	39.47	36.83
PHEC68P-S21L	34/ROW X 2 ROWS	58.68	55.88	54.43	44.55	41.91
PHEC80P-S21L	40/ROW X 2 ROWS	66.3	63.5	62.05	52.17	49.53
PHEC100P-S21L	50/ROW X 2 ROWS	79.0	76.2	74.75	64.87	62.23
PHEC120P-S21L	60/ROW X 2 ROWS	91.7	88.9	87.45	77.57	74.93

CONTACT PLATING TABLE

CONTACT AREA	REMAINDER
GOLD 0.25 MIN	SOLDER
OVER NICKEL 3.2 OVER NICKEL	

PRINTED CIRCUIT CONNECTOR  
 CAT. NO. PHEC\_P-S21L  
 DRAWING NO. JSC 90735  
 REV. 3  
**BURNDY JAPAN, Ltd.**

DESIGNED  
 DRAWN *M. Oba*  
 CHECKED *A. Eb*  
 APPROVED *J. Nakagishi*  
 DATE Mar. 8, 1990

SCALE  
 DIM. IN mm  
 MATERIAL

REV.	DATE	DESCRIPTION	CHKD.
3	'92-8-11	30,34,50,68 POSITIONS ADDED.	<i>JK</i>
2	'90-6-5	EC 7866	<i>JK</i>
1	'90-4-20	EC 7837	<i>JK</i>

DRAWING NO. JSC 90735

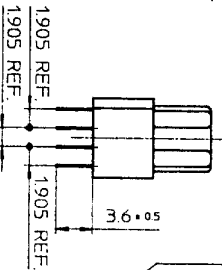
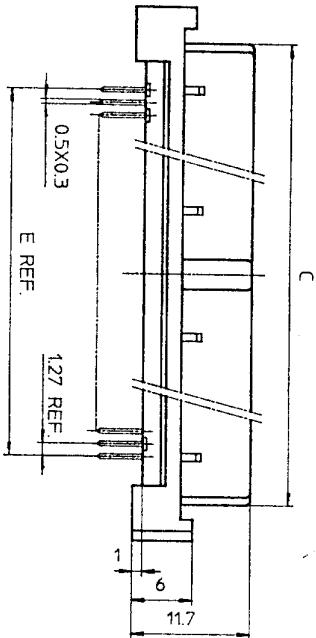
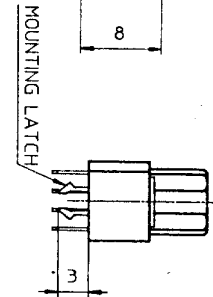
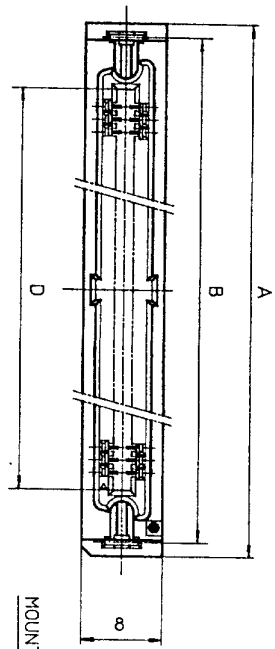

PHEC...R-S210

PHEC...R-S211

RECOMMENDED PC BOARD  
THICKNESS: 1.6 ± 0.2  
HOLE PATTERN (COMPONENT SIDE)  
NO. OF CONTACTS: 40, 60, 68, 80, 100, 120  
n : NO. OF CONTACTS

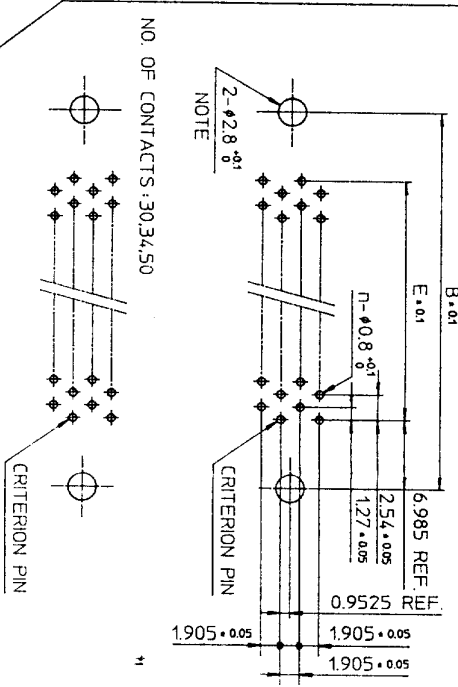

NOTE  
THROUGH-HOLES FOR MOUNTING LATCHES ALSO SHOULD BE PLATED.

TOLERANCES  
UNLESS OTHERWISE SPECIFIED: ±0.3

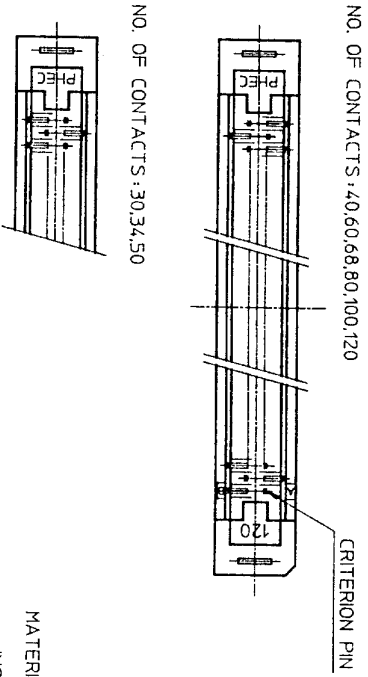

CAT. NO.	NO. OF CONTACTS (MATING SIDE)	DIMENSIONS				
		A	B	C	D	E
PHEC30R-S21	15/ROW X 2 ROWS	34.55	31.75	27.26	21.26	17.78
PHEC34R-S21	17/ROW X 2 ROWS	37.09	34.29	29.8	23.8	20.32
PHEC40R-S21	20/ROW X 2 ROWS	40.9	38.1	33.61	27.61	24.13
PHEC50R-S21	25/ROW X 2 ROWS	47.25	44.45	39.96	33.96	30.48
PHEC60R-S21	30/ROW X 2 ROWS	53.6	50.8	46.31	40.31	36.83
PHEC68R-S21	34/ROW X 2 ROWS	58.68	55.88	51.39	45.39	41.91
PHEC80R-S21	40/ROW X 2 ROWS	66.3	63.5	59.01	53.01	49.53
PHEC100R-S21	50/ROW X 2 ROWS	79.0	76.2	71.71	65.71	62.23
PHEC120R-S21	60/ROW X 2 ROWS	91.7	88.9	84.41	78.41	74.93

MATERIAL

INSULATOR: PBT RESIN GLASS REINFORCED (UL-94V-0)  
COLOR: BLACK

CONTACT: PHOSPHOR BRONZE  
MOUNTING LATCH: PHOSPHOR BRONZE  
SOLDER PLATED

CONTACT PLATING TABLE

CONTACT AREA	REMAINDER	SOLDER
GOLD 0.25 MIN. OVER NICKEL 3.2		OVER NICKEL

DRAWING NO. JSC 90737

PRINTED CIRCUIT CONNECTOR  
CAT. NO. PHEC...R-S21  
DRAWING NO. JSC 90737  
REV 4  
**BURNDY JAPAN, Ltd.**

DESIGNED  
DRAWN *M. Oba*  
CHECKED *A. Ch*  
APPROVED *J. Nakagishi*  
DATE Mar. 8, 1990

SCALE  
DIM IN MM  
MATERIAL

REV. DATE	DESCRIPTION	CKD
4-93	WRONG CONTACT DIM. CORRECTED.	
1-29	30,34,50,68 POSITIONS ADDED	<i>no S.P</i>
3-8-93	EC 7866	<i>no JK</i>
2-5-90	EC 7837	<i>no JK</i>
1-4-20		

DRAWING NO.  
JSC 90739

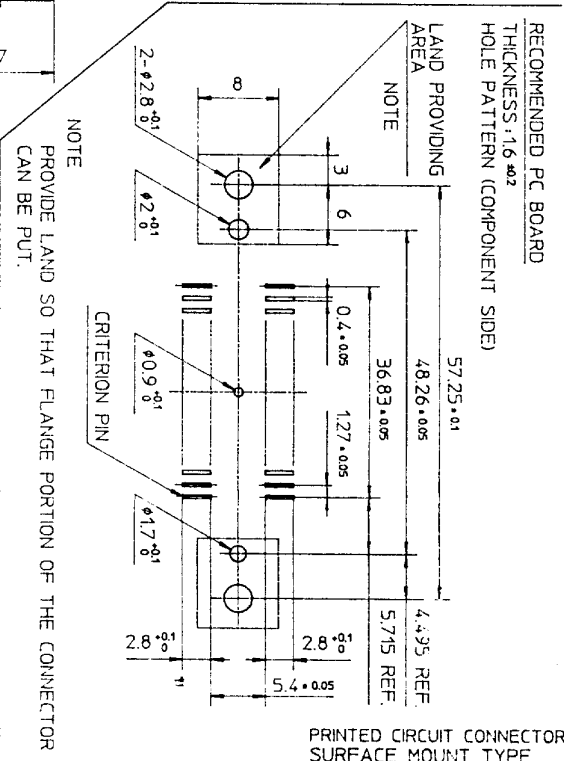
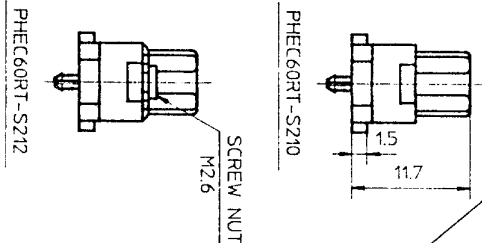
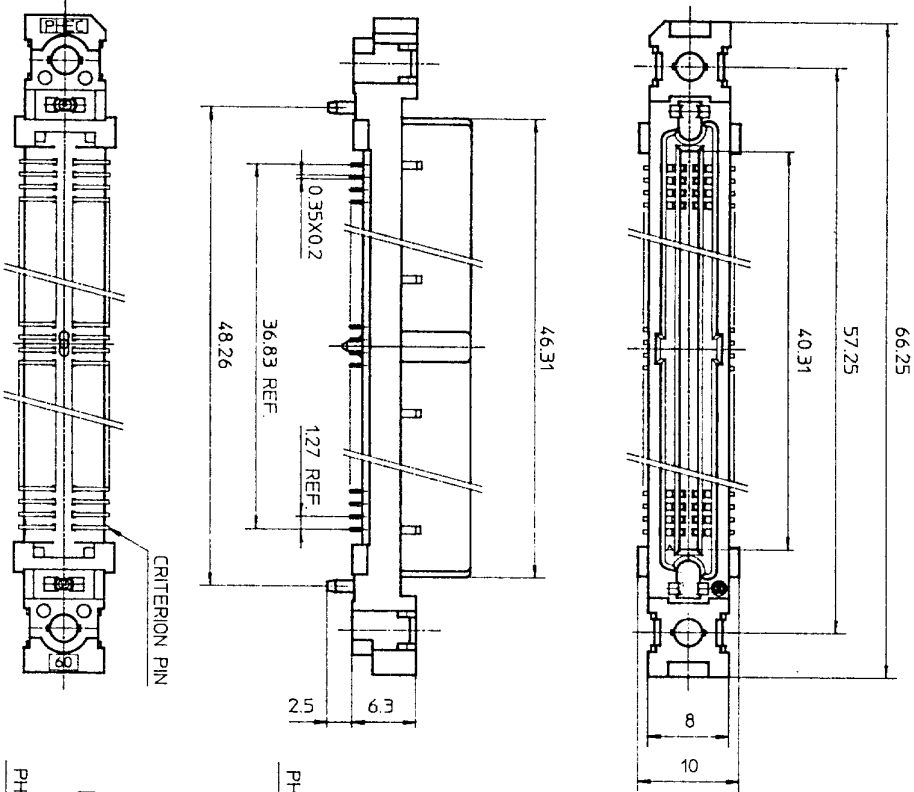

MATERIAL  
INSULATOR : PPS RESIN GLASS REINFORCED (UL94V-0)  
COLOR : BLACK  
CONTACT : PHOSPHOR BRONZE  
SCREW NUT : STAINLESS  
NO. OF CONTACTS : 30/ROW X 2 ROWS (MATING SIDE)

CONTACT PLATING TABLE  
(THICKNESS :  $\mu\text{m}$ )

CONTACT AREA	REMAINDER
GOLD 0.25 MIN.	SOLDER
OVER NICKEL 3Z	OVER NICKEL

TOLERANCES  
UNLESS OTHERWISE SPECIFIED :  $\pm 0.3$

PRINTED CIRCUIT CONNECTOR  
SURFACE MOUNT TYPE

REV	DATE	DESCRIPTION	CHK.
4	'92 8-14	WRONG CONTACT DIM. CORRECTED 100 POSITIONS OF DELETED.	M. Oba
3	'92 1-8	DIM. CHANGED.	J.K
2	'90 6-8	EC7866	J.K
1	'90 4-20	VARIATION ADDED.	J.K
REFERENCE			

SCALE	1:1
DIM IN	mm
MATERIAL	

DESIGNED	
DRAWN	M. Oba
CHECKED	J.K
APPROVED	J. Koyashi
DATE	Mar. 8, 1990

CAT. NO.	PHEC60RT-S212
DRAWING NO.	JSC 90739
REV	4

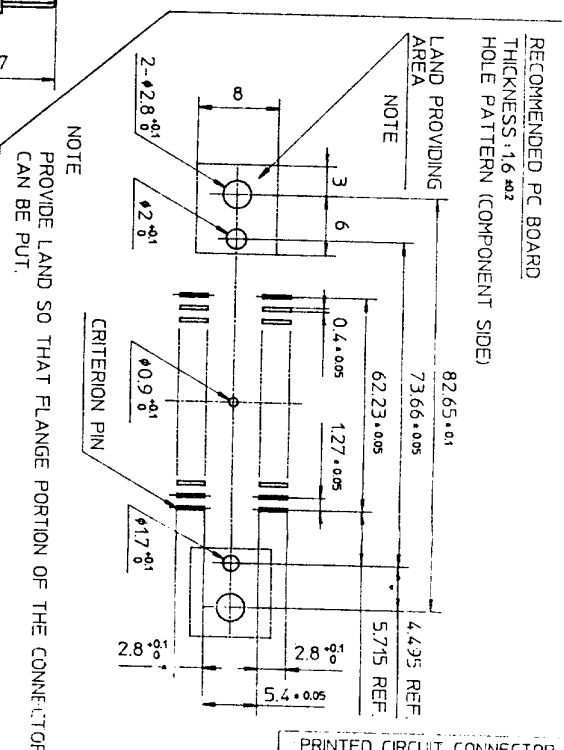
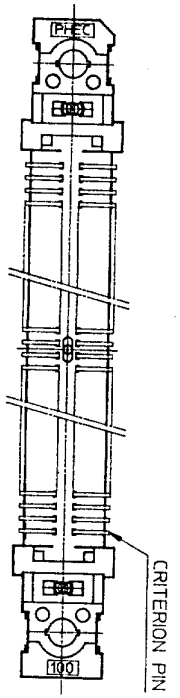
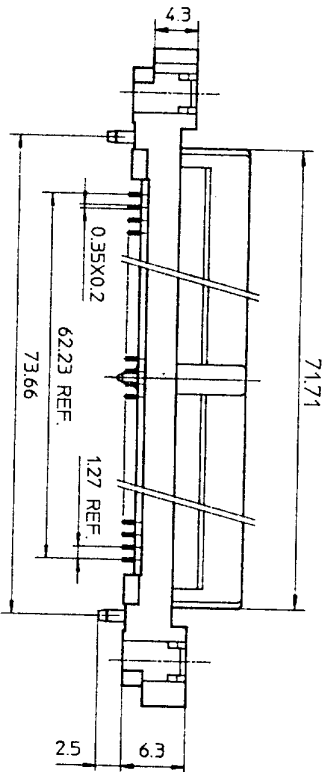
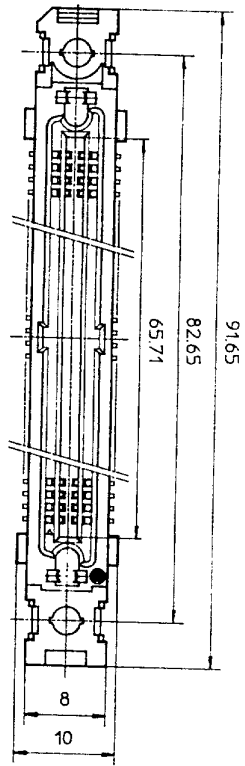

RECOMMENDED PC BOARD THICKNESS: 1.6 ±0.2 HOLE PATTERN (COMPONENT SIDE)

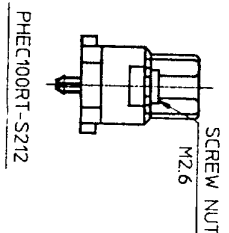
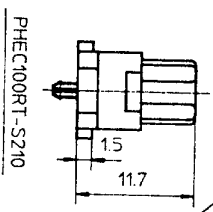

TOLERANCES UNLESS OTHERWISE SPECIFIED: ±0.3

MATERIAL  
 INSULATOR : PPS RESIN GLASS REINFORCED (UL94V-0)  
 COLOR : BLACK  
 CONTACT : PHOSPHOR BRONZE  
 SCREW NUT : STAINLESS  
 NO. OF CONTACTS : 50/ROW X 2 ROWS (MATING SIDE)

CONTACT PLATING TABLE (THICKNESS: μm)

CONTACT AREA	REMAINDER
GOLD 0.25 MIN OVER NICKEL 3.2	SOLDER OVER NICKEL

PRINTED CIRCUIT CONNECTOR SURFACE MOUNT TYPE

CAT. NO. PHEC100RT-S21L

DRAWING NO. JSC 91839 REV. 0

**BURNDY JAPAN Ltd.**

DESIGNED: *[Signature]*  
 DRAWN: *[Signature]*  
 CHECKED: *[Signature]*  
 APPROVED: *[Signature]*  
 DATE: Aug. 11, 1992

SCALE: *[Symbol]*  
 DIM. IN: mm  
 MATERIAL:

REV.	DATE	DESCRIPTION	CHKD.

REFERENCE

DRAWING NO. JSC 91839

DRAWING NO. JSC 90752

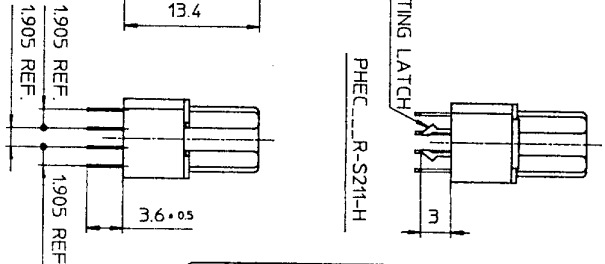
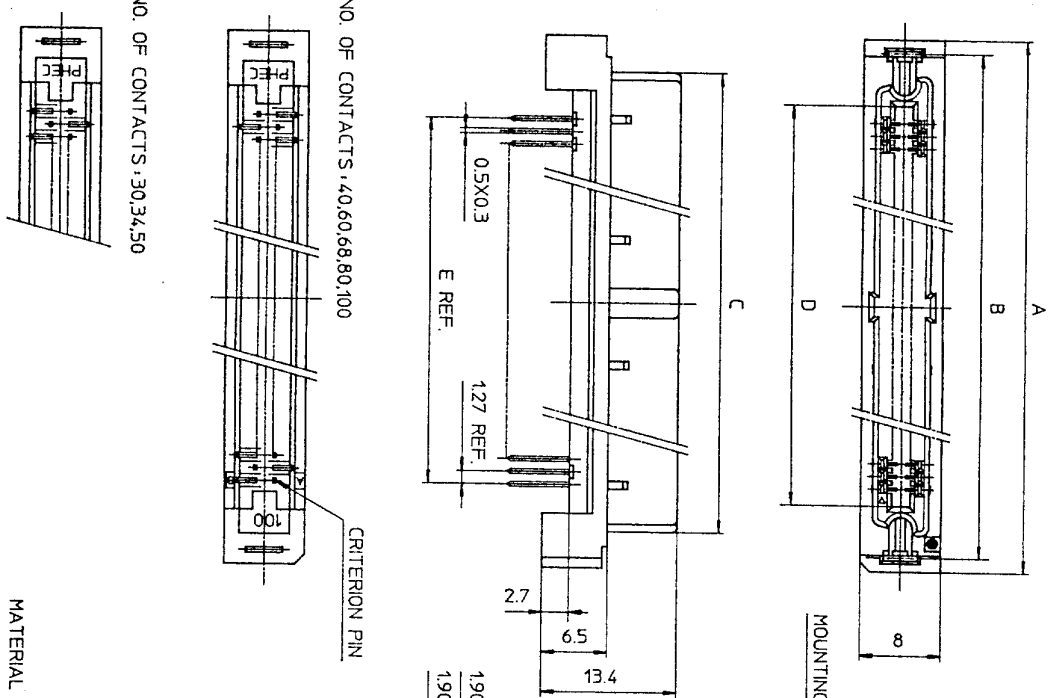

PHEC...R-S211-H

PHEC...R-S210-H

RECOMMENDED PC BOARD

THICKNESS : 1.6 ±0.2  
HOLE PATTERN (COMPONENT SIDE)

NO. OF CONTACTS : 40,60,68,80,100

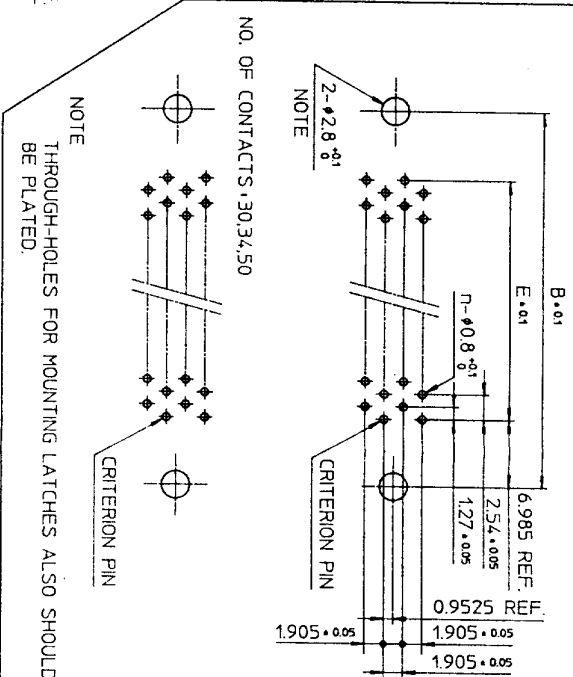

NO. OF CONTACTS : 30,34,50

NOTE  
THROUGH-HOLES FOR MOUNTING LATCHES ALSO SHOULD BE PLATED.

TOLERANCES UNLESS OTHERWISE SPECIFIED, ±0.3

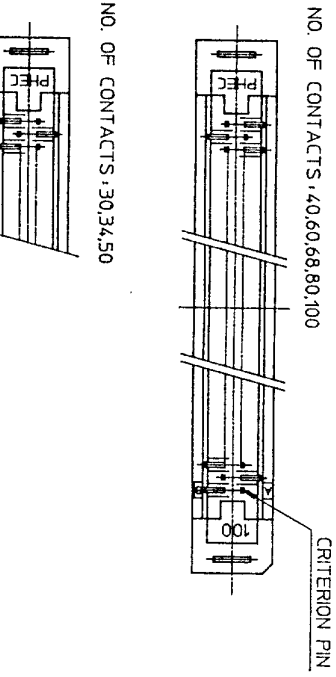

NO. OF CONTACTS : 40,60,68,80,100

NO. OF CONTACTS : 30,34,50

CRITERION PIN

CAT. NO.	NO. OF CONTACTS (MATING SIDE)	DIMENSIONS				
		A	B	C	D	E
PHEC30R-S21-H	15/ROW X 2 ROWS	34.55	31.75	27.26	21.26	17.78
PHEC34R-S21-H	17/ROW X 2 ROWS	37.09	34.29	29.8	23.8	20.32
PHEC40R-S21-H	20/ROW X 2 ROWS	40.9	38.1	33.61	27.61	24.13
PHEC50R-S21-H	25/ROW X 2 ROWS	47.25	44.45	39.96	33.96	30.48
PHEC60R-S21-H	30/ROW X 2 ROWS	53.6	50.8	46.31	40.31	36.83
PHEC68R-S21-H	34/ROW X 2 ROWS	58.68	55.88	51.39	45.39	41.91
PHEC80R-S21-H	40/ROW X 2 ROWS	66.3	63.5	59.01	53.01	49.53
PHEC100R-S21-H	50/ROW X 2 ROWS	79.0	76.2	71.71	65.71	62.23

MATERIAL

INSULATOR : PBT RESIN GLASS REINFORCED (UL94V-0)

COLOR : BLACK

CONTACT : PHOSPHOR BRONZE

MOUNTING LATCH : PHOSPHOR BRONZE  
SOLDER PLATED

CONTACT PLATING TABLE

CONTACT AREA	REMAINDER
GOLD 0.25 MIN	SOLDER
OVER NICKEL 3.2	OVER NICKEL

REV	DATE	DESCRIPTION	CHKD.
5	93-6-22	100 POSITIONS ADDED.	M.O
4	93-2-1	WRONG CONTACT DIM. CORRECTED.	5.9
3	92-8-11	100,120 POSITIONS DELETED. 30,34,50,68 POSITIONS ADDED.	5.9
2	90-5-30	DIM. CHANGED (36.61 → 33.61)	5
1	90-5-14	EC 7866	HE

SCALE  
DIM. IN  
MATERIAL

DESIGNED  
DRAWN  
CHECKED  
APPROVED  
DATE

PRINTED CIRCUIT CONNECTOR  
HIGH STAND OFF TYPE

CAT. NO. PHEC...R-S21-H

DRAWING NO. JSC 90752

REV. 5

**BURNDY JAPAN, Ltd.**



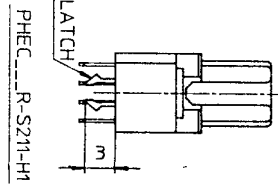
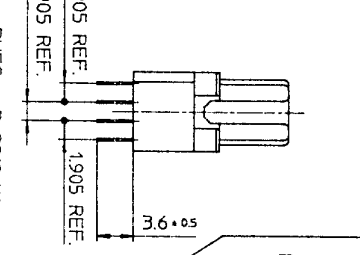
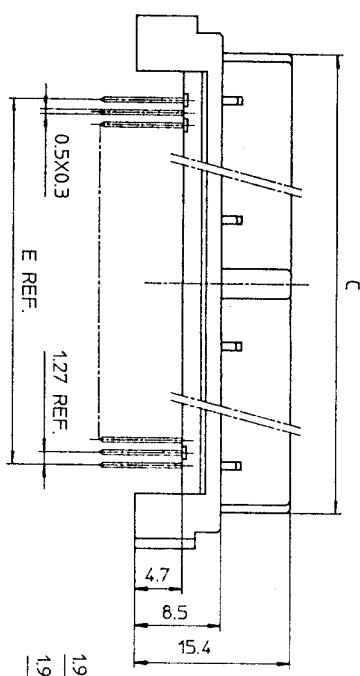
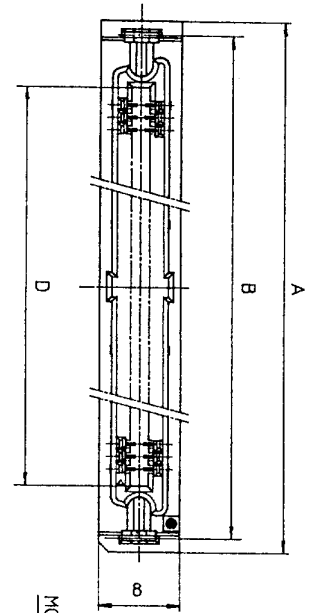

RECOMMENDED PC BOARD  
THICKNESS: 1.6 ±0.2  
HOLE PATTERN (COMPONENT SIDE)  
NO. OF CONTACTS: 40,60,68

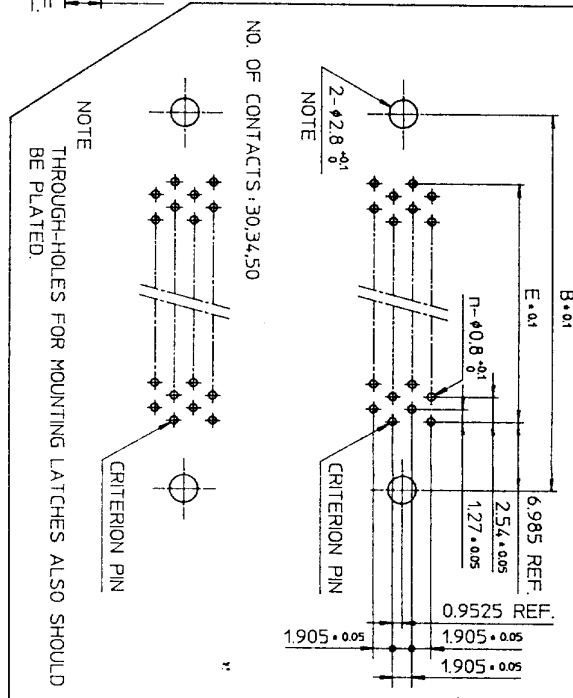

NO. OF CONTACTS: 40,60,68

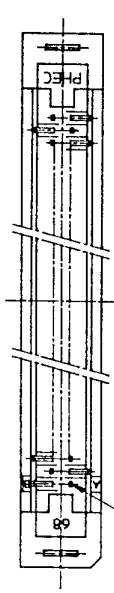

NO. OF CONTACTS: 30,34,50

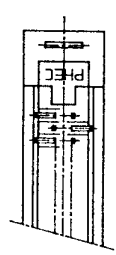

CAT. NO.	NO. OF CONTACTS (MATING SIDE)	DIMENSIONS				
		A	B	C	D	E
PHEC30R-S21-H1	15/ROW X 2 ROWS	34.55	31.75	27.26	21.26	17.78
PHEC34R-S21-H1	17/ROW X 2 ROWS	37.09	34.29	29.8	23.8	20.32
PHEC40R-S21-H1	20/ROW X 2 ROWS	40.9	38.1	33.61	27.61	24.13
PHEC50R-S21-H1	25/ROW X 2 ROWS	47.25	44.45	39.96	33.96	30.48
PHEC60R-S21-H1	30/ROW X 2 ROWS	53.6	50.8	46.31	40.31	36.83
PHEC68R-S21-H1	34/ROW X 2 ROWS	58.68	55.88	51.39	45.39	41.91

TOLERANCES  
UNLESS OTHERWISE SPECIFIED: ±0.3

MATERIAL

INSULATOR: PBT RESIN GLASS REINFORCED (UL94V-0)  
COLOR: BLACK

CONTACT: PHOSPHOR BRONZE  
MOUNTING LATCH: PHOSPHOR BRONZE  
SOLDER PLATED

CONTACT PLATING TABLE  
(THICKNESS: μm)

CONTACT AREA	REMAINDER
GOLD 0.25 MIN. OVER NICKEL 3.2	SOLDER OVER NICKEL

DRAWING NO. JSC 91840

PRINTED CIRCUIT CONNECTOR  
HIGH STAND OFF TYPE  
CAT. NO. PHEC\_R-S21-H1  
DRAWING NO. JSC 91840  
REV. 1  
**BURNDY JAPAN, Ltd.**

DESIGNED  
DRAWN M. Oba  
CHECKED A. Matsuo  
APPROVED S. Ito  
DATE Aug. 17, 1992

SCALE 1:1  
DIM IN mm  
MATERIAL  
WRONG CONTACT DIM. CORRECTED.

REV	DATE	DESCRIPTION	CKD
1	93	WRONG CONTACT DIM. CORRECTED.	
2	91		

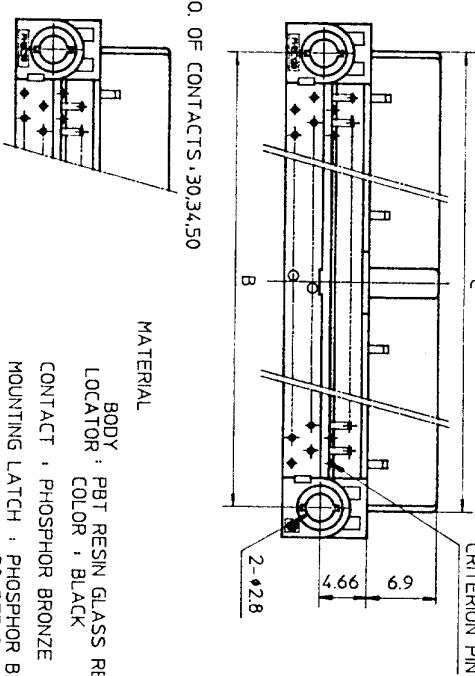
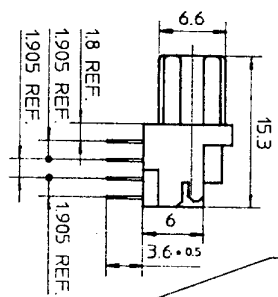
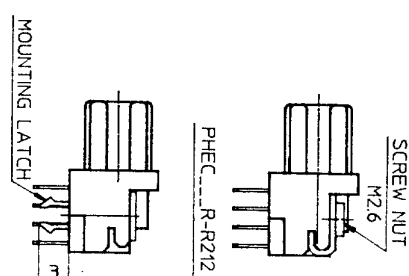
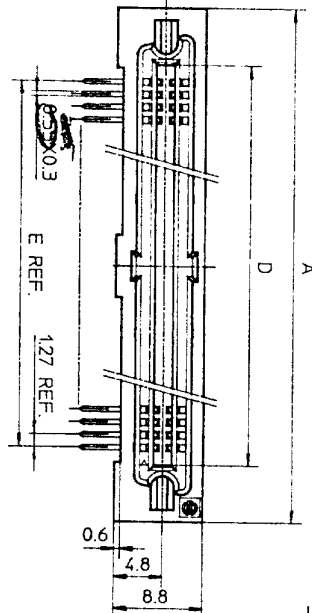
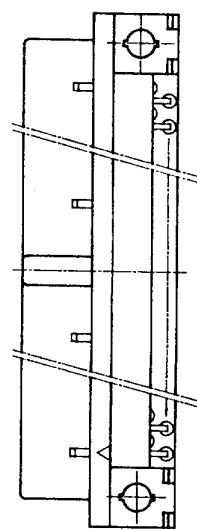

DRAWING NO  
JSC 90738

MATERIAL  
BODY : PBT RESIN GLASS REINFORCED (UL94V-0)  
LOCATOR COLOR : BLACK  
CONTACT : PHOSPHOR BRONZE  
MOUNTING LATCH : PHOSPHOR BRONZE  
SCREW NUT : STEEL  
NICKEL PLATED

RECOMMENDED PC BOARD  
THICKNESS: 1.6 ±0.2  
HOLE PATTERN (COMPONENT SIDE)  
NO. OF CONTACTS: 40,60,68,80,  
100,120

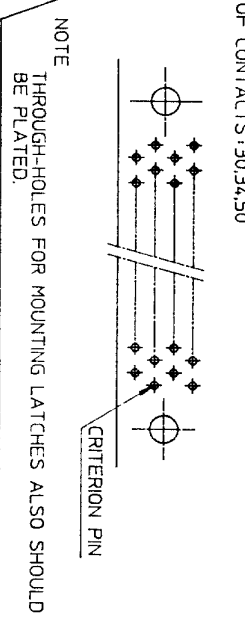
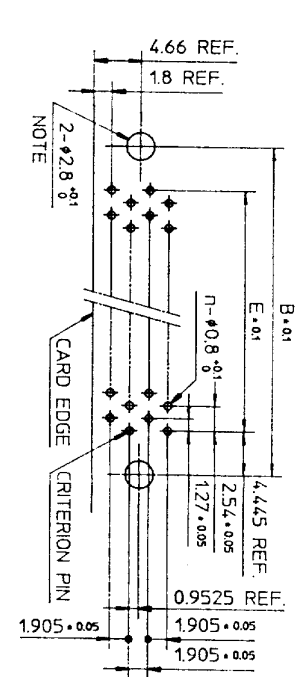

NOTE  
THROUGH-HOLES FOR MOUNTING LATCHES ALSO SHOULD BE PLATED.  
TOLERANCES UNLESS OTHERWISE SPECIFIED: ±0.3

CAT. NO.	NO. OF CONTACTS (MATING SIDE)	DIMENSIONS				
		A	B	C	D	E
PHEC30R-R21	15/ROW X 2 ROWS	32.67	26.67	27.26	21.26	17.78
PHEC34R-R21	17/ROW X 2 ROWS	35.21	29.21	29.8	23.8	20.32
PHEC40R-R21	20/ROW X 2 ROWS	39.02	33.02	33.61	27.61	24.13
PHEC50R-R21	25/ROW X 2 ROWS	45.37	39.37	39.96	33.96	30.48
PHEC60R-R21	30/ROW X 2 ROWS	51.72	45.72	46.31	40.31	36.83
PHEC68R-R21	34/ROW X 2 ROWS	56.8	50.8	51.39	45.39	41.91
PHEC80R-R21	40/ROW X 2 ROWS	64.42	58.42	59.01	53.01	49.53
PHEC100R-R21	50/ROW X 2 ROWS	77.12	71.12	71.71	65.71	62.23
PHEC120R-R21	60/ROW X 2 ROWS	89.82	83.82	84.41	78.41	74.93

CONTACT PLATING TABLE  
(THICKNESS: μm)

CONTACT AREA	REMAINDER
GOLD 0.25 MIN.	SOLDER
OVER NICKEL 3.2	OVER NICKEL

REV. DATE	DESCRIPTION	CKD	SCALE	DESIGNED	PRINTED CIRCUIT CONNECTOR
3	30,34,50,68 POSITIONS ADDED.	1.2	DIM. IN mm	M. Osa	CAT. NO. PHEC...R-R21
2	EC 7866	2.0	MATERIAL	CHECKED	DRAWING NO. JSC 90738
1	EC 7837	2.0		APPROVED	REV. 3
REFERENCE				DATE	BURNDY JAPAN, Ltd.