



PRODUCT NO.10035690-XXX-3W

B

A

1 | 2

3 |

4

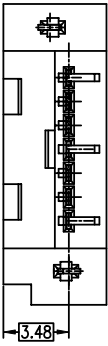
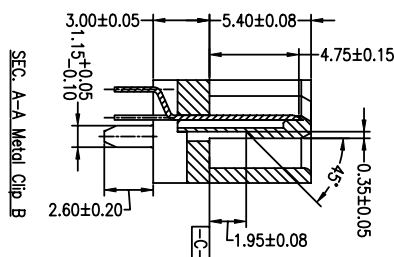
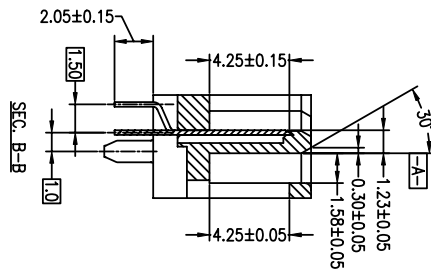
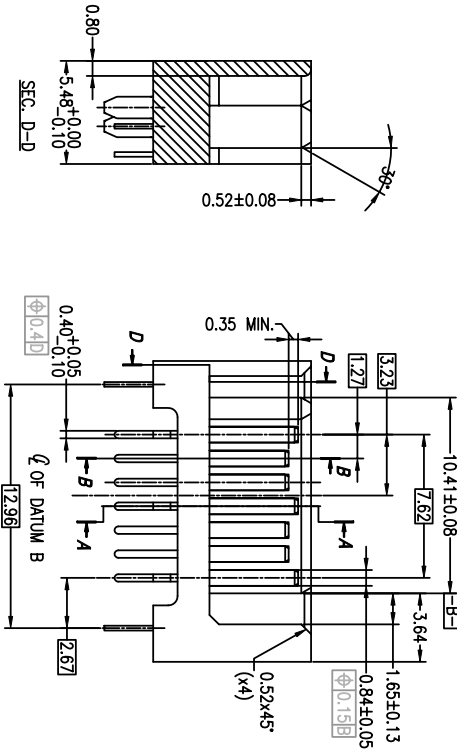
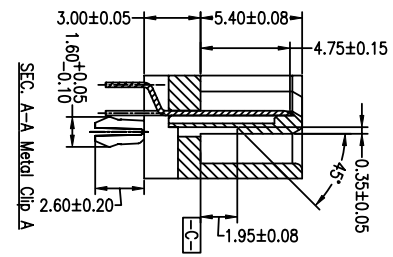
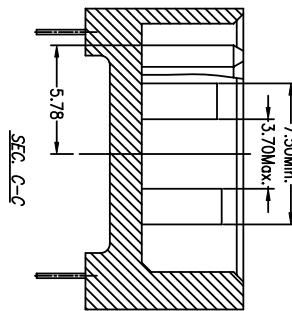
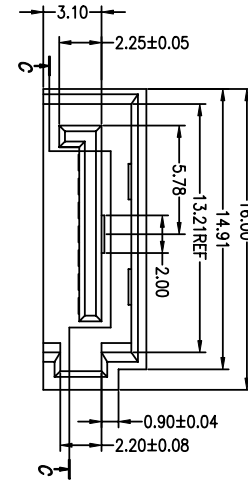

1 | 2

3 |

4

ACAD

code code

mat'l. code			tolerances unless otherwise specified			CUSTOMER COPY			FCI		
lir	ecn no	dr	date	linear	XX ± 0.30	projection	MM	product family	SATA	code	sheet
A	105-0213	W.L	09/09/05	.XXX ± 0.10		projection	MM	S-ATA SIGNAL PLUG		TWN	1 of
B	108-1033	S.Lin	02/29/08	0° ± 2°		projection	MM	DIP VERTICAL TYPE ASSY		TWN	1 of
sheet	revision	sheet	index	dr	Wade Liu	09/09/05	scdle	size	10035690	code	sheet
				enfr	Wade Liu	09/09/05					
				appr	Sterling Lin	09/09/05					



PRODUCT NO.10035690-XXX-4W

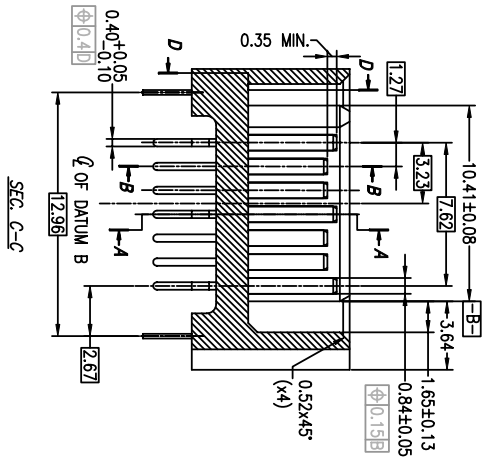
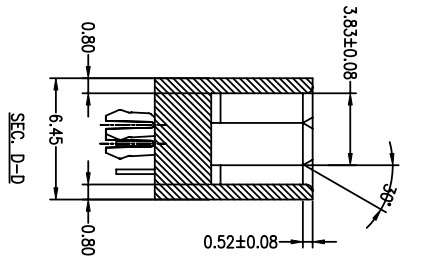
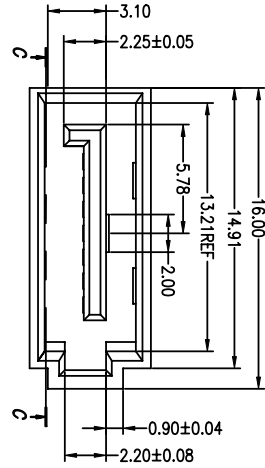

SUF-FIX	DIM C	DIM D
OTHERS	2.05MM	2.60MM
-XX4XLF	3.05MM	3.40MM

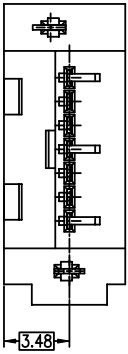
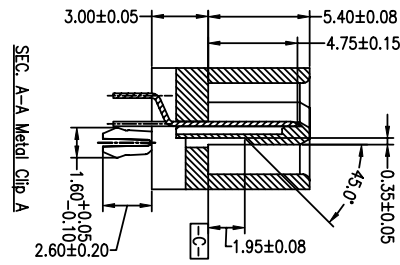
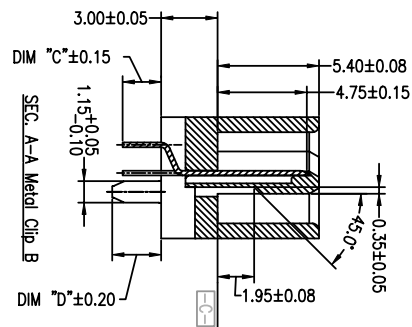
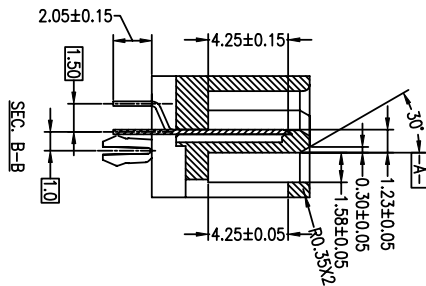

mat'l. code		tolerances unless otherwise specified		CUSTOMER COPY		FCI		title	
lit	ecn no	dr	date	.X ± 0.30		projection		S-ATA SIGNAL PLUG	
A	T05-0213	W.L	09/09/05	.XX ± 0.20		MM		DIP VERTICAL TYPE ASSY	
B	T08-1033	S.Lin	02/29/08	.XXX ± 0.10		NA		product family SATA	
		angles		0° ± 2°		size		code	
		dr		09/09/05		A4		10035690	
		engr		09/09/05		code		TWN	
		chr		09/09/05		sheet		2 of	
		appd		09/09/05		sheet			
sheet	revision	sheet	1	2	3	code			
index	sheet	sheet	1	2	3	code			

ACAD

3

4

1 | 2

3

4



1 | 2

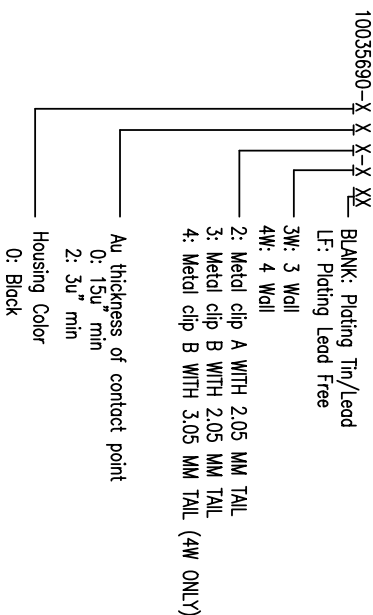
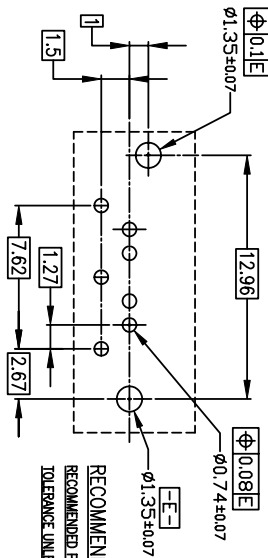

3 |

4

- NOTES :
- MATERIAL
 - HOUSING : HIGH TEMPERATURE THERMOPLASTIC UL94V-0
 - TERMINAL : COPPER ALLOY
 - HOULD DOWN : COPPER ALLOY
 - FINISH
 - TERMINAL : Au PLATING AT CONTACT POINT
100u" min Sn-Pb or PURE TIN PLATING AT SOLDER TAIL WITH NICKEL UNDERPLATE
 - HOULD DOWN : 100-200 u" Sn-Pb or PURE TIN PLATING.
 - P/N : 10035690-XXXXLF
THE HOUSING WILL WITHSTAND EXPOSURE TO 260 DEGREE C PEAK TEMPERATURE FOR 10 SECONDS IN A WAVE SOLDER APPLICATION WITH 1.6MM MINIMUM THICK CIRCUIT BOARD.
 - Packaging spec: GS-14-840.
 - Product Spec: GS-12-194.

1 | 2

mat'l. code		tolerances unless otherwise specified		CUSTOMER COPY		title		www.fciconnect.com	
ltr	ecn no	dr	date	linear	projection	product family	SATA	code	
A	T05-0213	W.L	09/09/05	.XX ± 0.20	MM	S-ATA SIGNAL PLUG		TWN	
B	T08-1033	S.Lin	02/29/08	.XXX ± 0.10	MM	DIP VERTICAL TYPE ASSY		sheet	3 of
		angles		0° ±2°	scale	10035690			
		dr	09/09/05						
		Wade Liu	09/09/05						
		engr	09/09/05						
		chr	09/09/05						
		appr	09/09/05						
sheet	revision								
index	sheet	B	B	B					
		1	2	3					

ACAD

3 |

4