

NO. OF CONTACTS : 40,60,68,80,100,120
CRITERION PIN

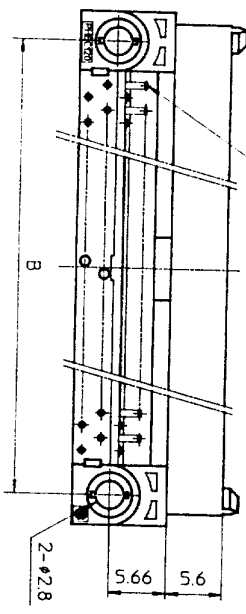

NO. OF CONTACTS : 30,34,50

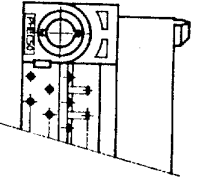

DRAWING NO.
JSC 90736

RECOMMENDED PC BOARD
THICKNESS : 1.6 ± 0.2
HOLE PATTERN (COMPONENT SIDE)

NO. OF CONTACTS : 40,60,68,80,100,120

n : NO. OF CONTACTS

TOLERANCES
UNLESS OTHERWISE SPECIFIED : ± 0.3

CAT. NO.	NO. OF CONTACTS (MATING SIDE)	DIMENSIONS				
		A	B	C	D	E
PHEC30P-R21	15/ROW X 2 ROWS	32.67	26.67	30.3	20.42	17.78
PHEC34P-R21	17/ROW X 2 ROWS	35.21	29.21	32.84	22.96	20.32
PHEC40P-R21	20/ROW X 2 ROWS	39.02	33.02	36.65	26.77	24.13
PHEC50P-R21	25/ROW X 2 ROWS	45.37	39.37	43	33.12	30.48
PHEC60P-R21	30/ROW X 2 ROWS	51.72	45.72	49.35	39.47	36.83
PHEC68P-R21	34/ROW X 2 ROWS	56.8	50.8	54.43	44.55	41.91
PHEC80P-R21	40/ROW X 2 ROWS	64.42	58.42	62.05	52.17	49.53
PHEC100P-R21	50/ROW X 2 ROWS	77.12	71.12	74.75	64.87	62.23
PHEC120P-R21	60/ROW X 2 ROWS	89.82	83.82	87.45	77.57	74.93

MATERIAL : NYLON RESIN GLASS REINFORCED (UL94V-0)
BODY : BLACK
LOCATOR : PBT RESIN GLASS REINFORCED (UL94V-0)
COLOR : BLACK

CONTACT : COPPER ALLOY
MOUNTING LATCH : PHOSPHOR BRONZE
SCREW NUT : STEEL
NICKEL PLATED

CONTACT PLATING TABLE
(THICKNESS : μm)

CONTACT AREA	REMAINDER
GOLD 0.25 MIN. OVER NICKEL 3Z	SOLDER OVER NICKEL

DESIGNED	DRAWN <i>M. Oba</i>	CHECKED <i>4.8/</i>	APPROVED <i>J. Ogasawara</i>	DATE Mar. 8, 1990
PRINTED CIRCUIT CONNECTOR				
CAT. NO. PHEC__P-R21_		DRAWING NO. JSC 90736		
REV		3		
BURNDY JAPAN Ltd.				

REV	DATE	DESCRIPTION	CKD
92	8-14	30,34,50,68 POSITIONS ADDED. LOCATOR MATERIAL ADDED.	
2	6-7	EC 7866	
1	4-20	EC 7837	

CP-FHLC 02

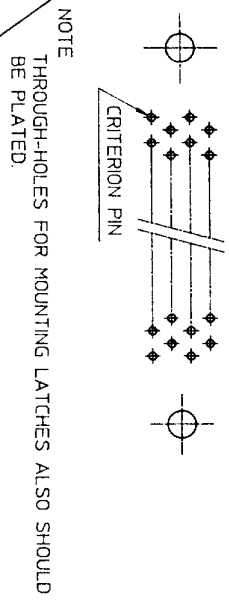
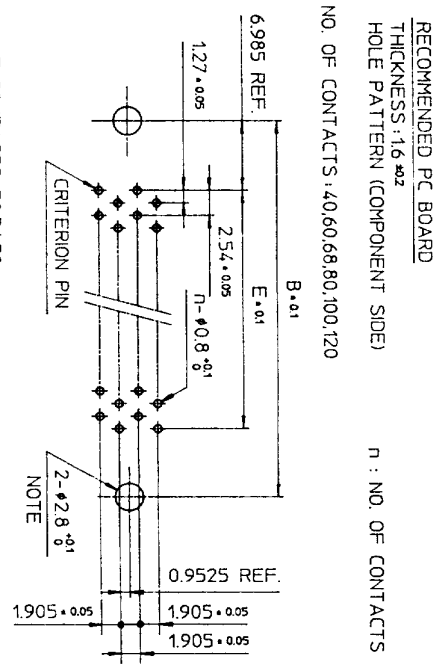
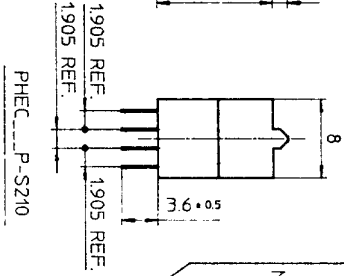
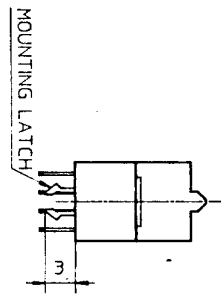
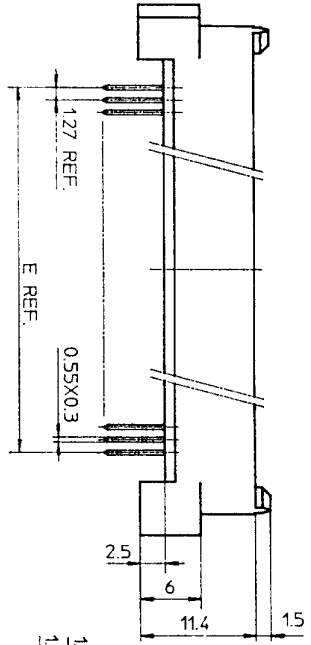
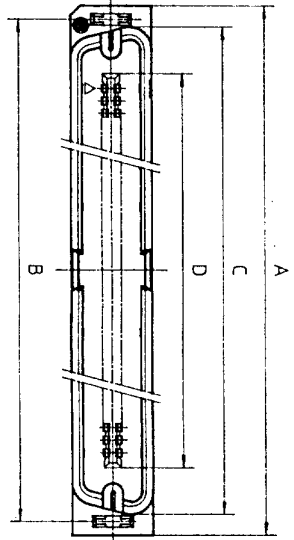

TOLERANCES UNLESS OTHERWISE SPECIFIED: ±0.3

NO. OF CONTACTS: 40,60,68,80,100,120

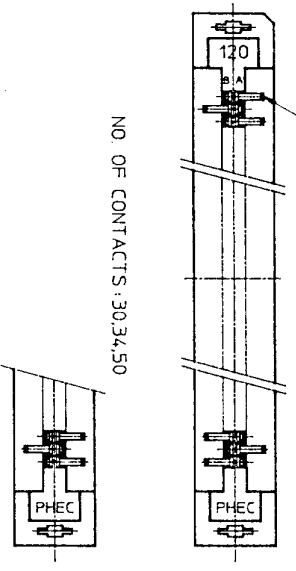

NO. OF CONTACTS: 30,34,50

CAT. NO.	NO. OF CONTACTS (MATING SIDE)	DIMENSIONS				
		A	B	C	D	E
PHEC30P-S21L	15/ROW X 2 ROWS	34.55	31.75	30.3	20.42	17.78
PHEC34P-S21L	17/ROW X 2 ROWS	37.09	34.29	32.84	22.96	20.32
PHEC40P-S21L	20/ROW X 2 ROWS	40.9	38.1	36.65	26.77	24.13
PHEC50P-S21L	25/ROW X 2 ROWS	47.25	44.45	4.3	33.12	30.48
PHEC60P-S21L	30/ROW X 2 ROWS	53.6	50.8	49.35	39.47	36.83
PHEC68P-S21L	34/ROW X 2 ROWS	58.68	55.88	54.43	44.55	41.91
PHEC80P-S21L	40/ROW X 2 ROWS	66.3	63.5	62.05	52.17	49.53
PHEC100P-S21L	50/ROW X 2 ROWS	79.0	76.2	74.75	64.87	62.23
PHEC120P-S21L	60/ROW X 2 ROWS	91.7	88.9	87.45	77.57	74.93

MATERIAL

INSULATOR : NYLON RESIN GLASS REINFORCED (UL94V-0)
 COLOR : BLACK
 CONTACT : COPPER ALLOY
 MOUNTING LATCH : PHOSPHOR BRONZE
 SOLDER PLATED

CONTACT PLATING TABLE

CONTACT AREA	REMAINDER
GOLD 0.25 MIN	SOLDER
OVER NICKEL 3.2 OVER NICKEL	

PRINTED CIRCUIT CONNECTOR
 CAT. NO. PHEC_P-S21L
 DRAWING NO. JSC 90735
 REV. 3
BURNDY JAPAN, Ltd.

DESIGNED
 DRAWN *M. Oba*
 CHECKED *A. Eb*
 APPROVED *J. Nakagishi*
 DATE Mar. 8, 1990

SCALE
 DIM. IN mm
 MATERIAL

REV.	DATE	DESCRIPTION	CHKD.
3	'92-8-11	30,34,50,68 POSITIONS ADDED.	<i>JK</i>
2	'90-6-5	EC 7866	<i>JK</i>
1	'90-4-20	EC 7837	<i>JK</i>

DRAWING NO. JSC 90735

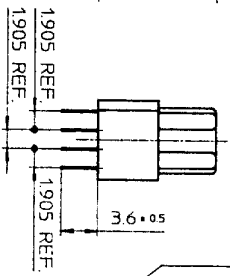
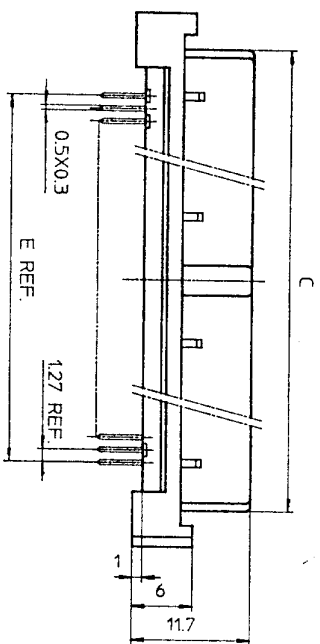
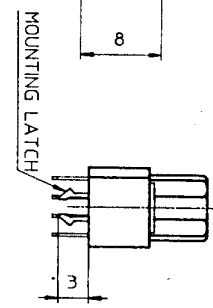
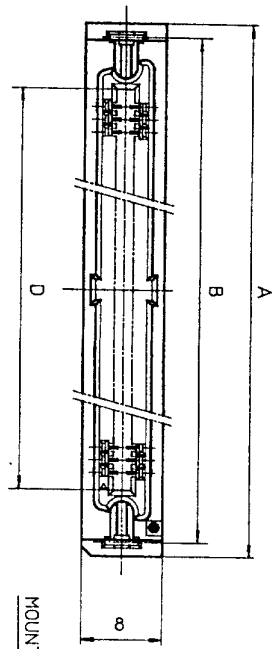

RECOMMENDED PC BOARD
 THICKNESS: 1.6 ± 0.2
 HOLE PATTERN (COMPONENT SIDE)
 NO. OF CONTACTS: 40, 60, 68, 80, 100, 120
 n : NO. OF CONTACTS

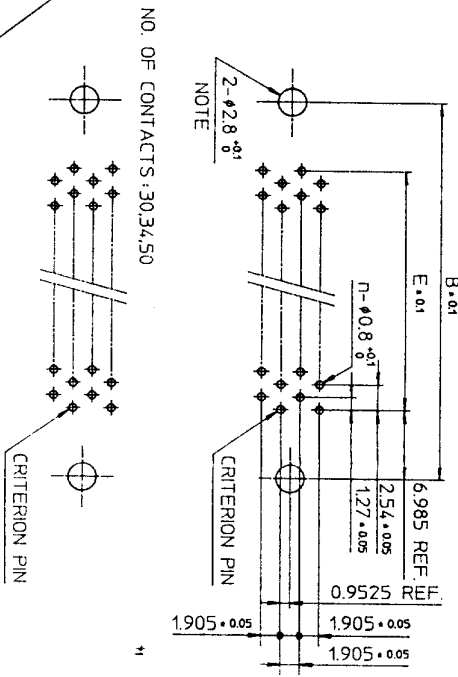

NOTE
 THROUGH-HOLES FOR MOUNTING LATCHES ALSO SHOULD BE PLATED.

TOLERANCES
 UNLESS OTHERWISE SPECIFIED: ±0.3

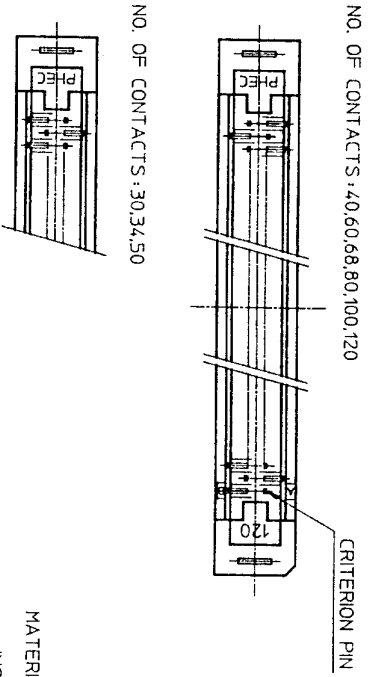

CAT. NO.	NO. OF CONTACTS (MATING SIDE)	DIMENSIONS				
		A	B	C	D	E
PHEC30R-S21	15/ROW X 2 ROWS	34.55	31.75	27.26	21.26	17.78
PHEC34R-S21	17/ROW X 2 ROWS	37.09	34.29	29.8	23.8	20.32
PHEC40R-S21	20/ROW X 2 ROWS	40.9	38.1	33.61	27.61	24.13
PHEC50R-S21	25/ROW X 2 ROWS	47.25	44.45	39.96	33.96	30.48
PHEC60R-S21	30/ROW X 2 ROWS	53.6	50.8	46.31	40.31	36.83
PHEC68R-S21	34/ROW X 2 ROWS	58.68	55.88	51.39	45.39	41.91
PHEC80R-S21	40/ROW X 2 ROWS	66.3	63.5	59.01	53.01	49.53
PHEC100R-S21	50/ROW X 2 ROWS	79.0	76.2	71.71	65.71	62.23
PHEC120R-S21	60/ROW X 2 ROWS	91.7	88.9	84.41	78.41	74.93

MATERIAL

INSULATOR: PBT RESIN GLASS REINFORCED (UL94V-0)
 COLOR: BLACK

CONTACT: PHOSPHOR BRONZE
 MOUNTING LATCH: PHOSPHOR BRONZE
 SOLDER PLATED

CONTACT PLATING TABLE

CONTACT AREA	REMAINDER	SOLDER
GOLD 0.25 MIN. OVER NICKEL 3.2		OVER NICKEL

DRAWING NO. JSC 90737

PRINTED CIRCUIT CONNECTOR
 CAT. NO. PHEC...R-S21
 DRAWING NO. JSC 90737
 REV. 4
BURNDY JAPAN, Ltd.

DESIGNED
 DRAWN *M. Oba*
 CHECKED *A. Ch...*
 APPROVED *J. Nakagawa*
 DATE Mar. 8, 1990

SCALE
 DIM IN MM
 MATERIAL

REV. DATE	DESCRIPTION	CKD
4-1-29	WRONG CONTACT DIM. CORRECTED.	
3-8-11	30,34,50,68 POSITIONS ADDED No. 5.9	
2-5-30	EC 7866 No. JK	
1-4-20	EC 7837 No. JK	

DRAWING NO.
JSC 90739

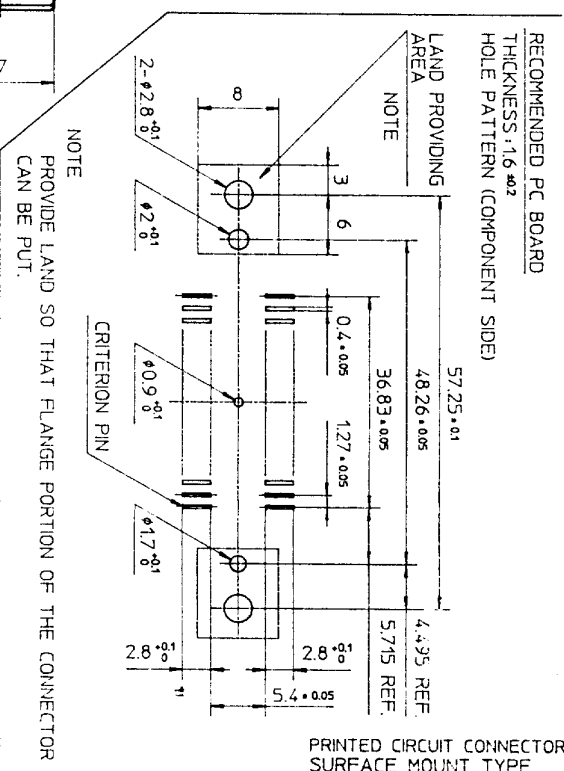
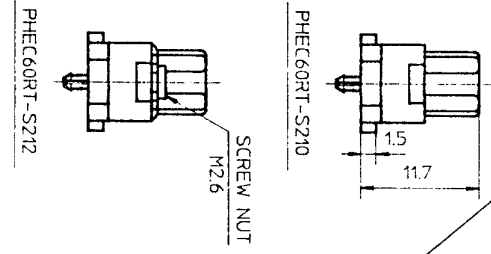
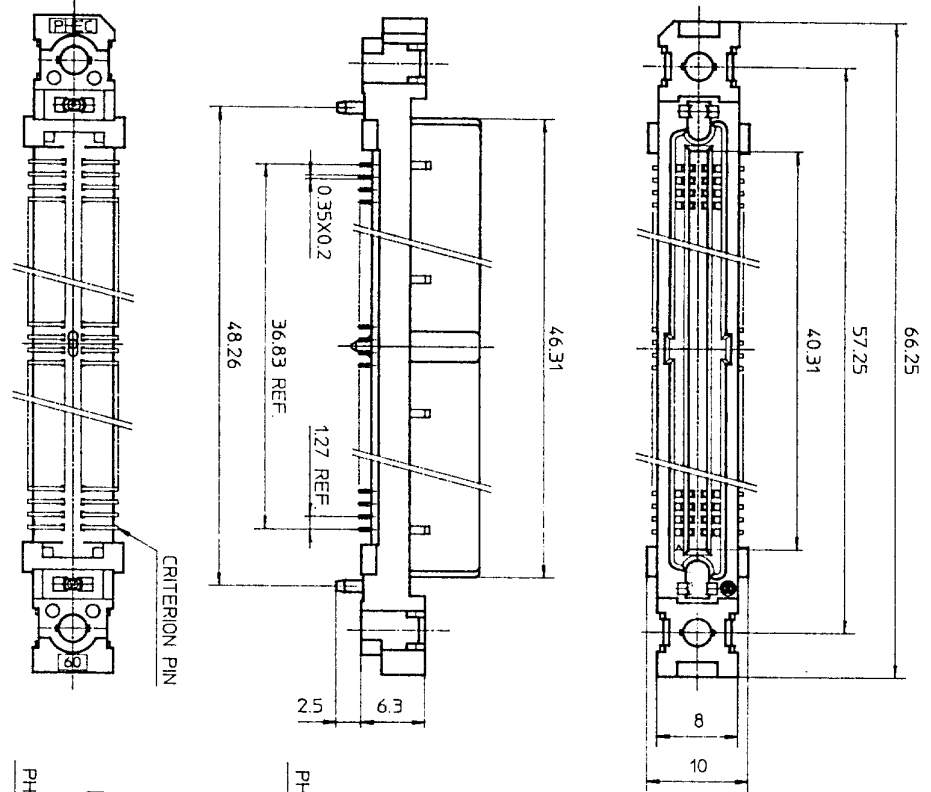

MATERIAL
INSULATOR : PPS RESIN GLASS REINFORCED (UL94V-0)
COLOR : BLACK
CONTACT : PHOSPHOR BRONZE
SCREW NUT : STAINLESS
NO. OF CONTACTS : 30/ROW X 2 ROWS (MATING SIDE)

CONTACT PLATING TABLE
(THICKNESS : μm)

CONTACT AREA	REMAINDER
GOLD 0.25 MIN. OVER NICKEL 3Z	SOLDER OVER NICKEL

TOLERANCES
UNLESS OTHERWISE SPECIFIED: ±0.3

PRINTED CIRCUIT CONNECTOR
SURFACE MOUNT TYPE

REV	DATE	DESCRIPTION	CHK.
4	'92 8-14	WRONG CONTACT DIM. CORRECTED 100 POSITIONS OF DELETED.	M. Oba
3	'92 1-8	DIM. CHANGED.	J. Kobayashi
2	'90 6-8	EC7866	J. Kobayashi
1	'90 4-20	VARIATION ADDED.	J. Kobayashi

SCALE	1:1
DIM IN	mm
MATERIAL	

DESIGNED	
DRAWN	M. Oba
CHECKED	J. Kobayashi
APPROVED	J. Kobayashi
DATE	Mar. 8, 1990

CAT. NO.	PHEC60RT-S212
DRAWING NO.	JSC 90739
REV	4

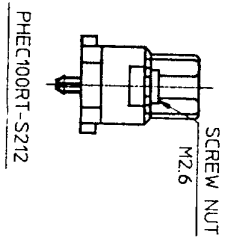
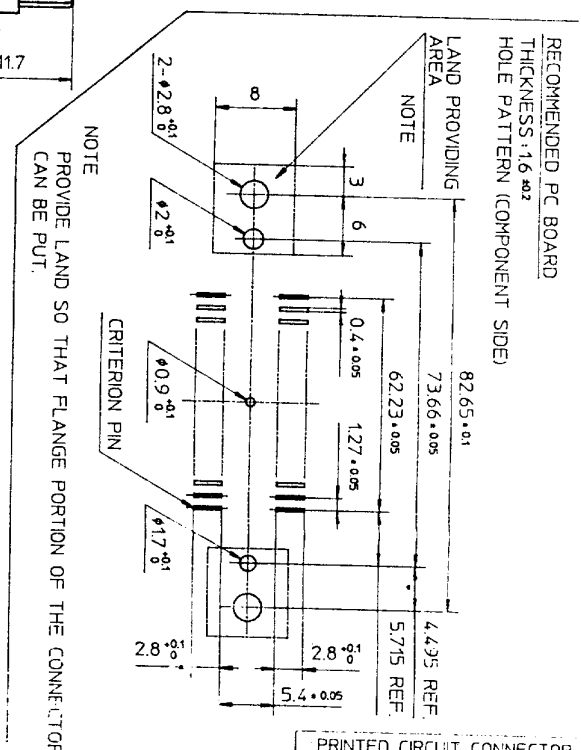
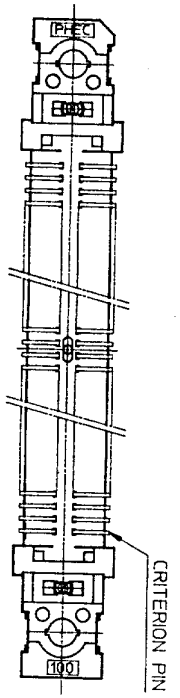
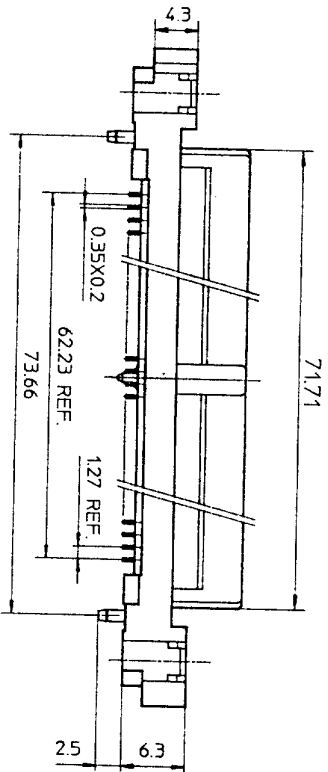
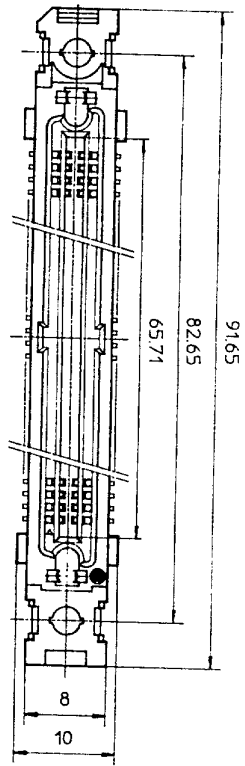

TOLERANCES
UNLESS OTHERWISE SPECIFIED: ±0.3

MATERIAL
INSULATOR: PPS RESIN GLASS REINFORCED (UL94V-0)
COLOR: BLACK
CONTACT: PHOSPHOR BRONZE
SCREW NUT: STAINLESS
NO. OF CONTACTS: 50/ROW X 2 ROWS (MATING SIDE)

CONTACT PLATING TABLE

CONTACT AREA	REMAINDER
GOLD 0.25 MIN OVER NICKEL 3.2	SOLDER OVER NICKEL

(THICKNESS: μm)

PRINTED CIRCUIT CONNECTOR
SURFACE MOUNT TYPE

CAT. NO. PHEC100RT-S21L

DRAWING NO. JSC 91839 REV. 0

BURNDY
JAPAN, Ltd.

DESIGNED: [Signature]
DRAWN: [Signature]
CHECKED: A. [Signature]
APPROVED: [Signature]
DATE: Aug. 11, 1992

SCALE: [Symbol]
DIM. IN: [Symbol]
MATERIAL:

REV.	DATE	DESCRIPTION	CHKD.

REFERENCE

DRAWING NO. JSC 91839

DRAWING NO. JSC 90752

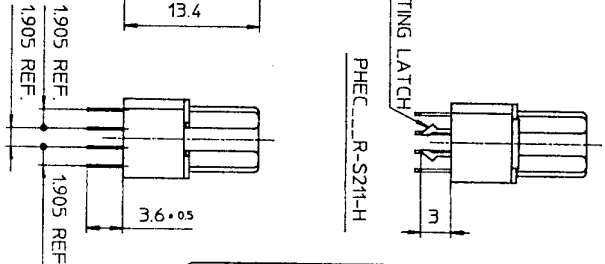
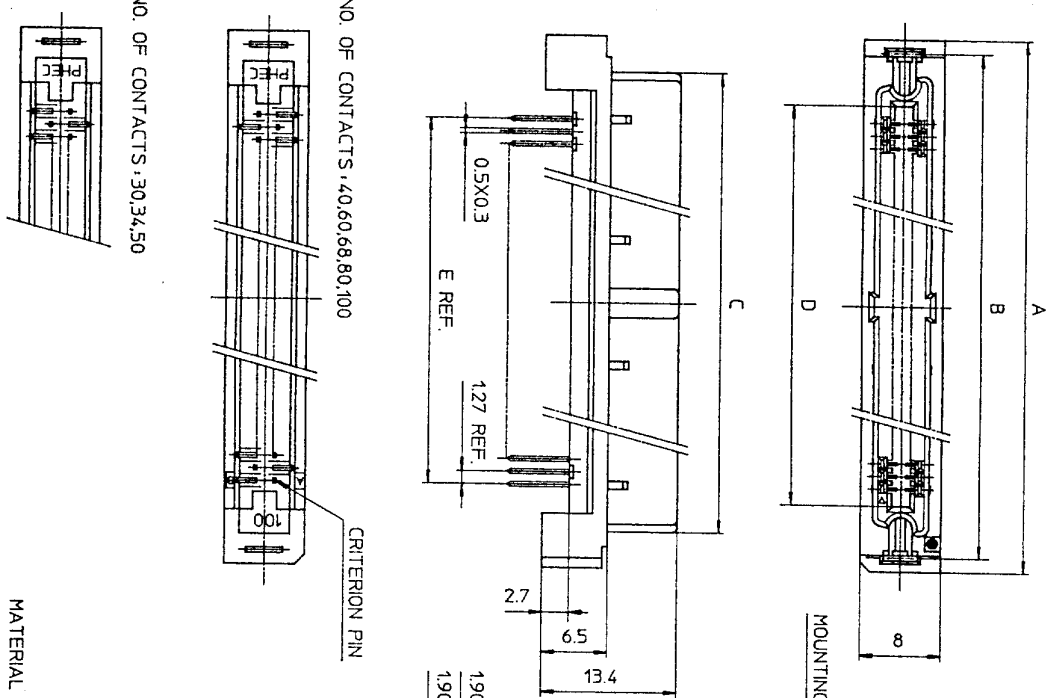

PHEC...R-S210-H

PHEC...R-S211-H

NO. OF CONTACTS : 40,60,68,80,100

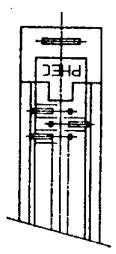

NO. OF CONTACTS : 30,34,50

RECOMMENDED PC BOARD THICKNESS : 1.6 ±0.2 HOLE PATTERN (COMPONENT SIDE) NO. OF CONTACTS : 40,60,68,80,100

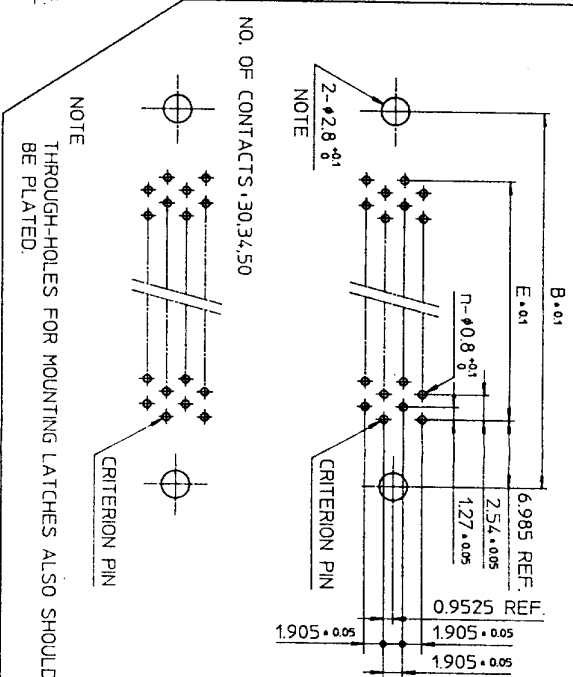

NOTE THROUGH-HOLES FOR MOUNTING LATCHES ALSO SHOULD BE PLATED.

NO. OF CONTACTS : 30,34,50

TOLERANCES UNLESS OTHERWISE SPECIFIED, ±0.3

CAT. NO.	NO. OF CONTACTS (MATING SIDE)	DIMENSIONS				
		A	B	C	D	E
PHEC30R-S21-H	15/ROW X 2 ROWS	34.55	31.75	27.26	21.26	17.78
PHEC34R-S21-H	17/ROW X 2 ROWS	37.09	34.29	29.8	23.8	20.32
PHEC40R-S21-H	20/ROW X 2 ROWS	40.9	38.1	33.61	27.61	24.13
PHEC50R-S21-H	25/ROW X 2 ROWS	47.25	44.45	39.96	33.96	30.48
PHEC60R-S21-H	30/ROW X 2 ROWS	53.6	50.8	46.31	40.31	36.83
PHEC68R-S21-H	34/ROW X 2 ROWS	58.68	55.88	51.99	45.99	41.91
PHEC80R-S21-H	40/ROW X 2 ROWS	66.3	63.5	59.01	53.01	49.53
PHEC100R-S21-H	50/ROW X 2 ROWS	79.0	76.2	71.71	65.71	62.23

MATERIAL

INSULATOR : PBT RESIN GLASS REINFORCED (UL94V-0)

COLOR : BLACK

CONTACT : PHOSPHOR BRONZE

MOUNTING LATCH : PHOSPHOR BRONZE SOLDER PLATED

CONTACT PLATING TABLE

CONTACT AREA	REMAINDER
GOLD 0.25 MIN	SOLDER
OVER NICKEL 3.2	OVER NICKEL

REV	DATE	DESCRIPTION	CHKD.
5	93-6-22	100 POSITIONS ADDED.	M.O
4	93-2-1	WRONG CONTACT DIM. CORRECTED.	5.9
3	92-8-11	100,120 POSITIONS DELETED. 30,34,50,68 POSITIONS ADDED.	5.9
2	90-5-30	DIM. CHANGED (36.61 → 33.61)	5
1	90-5-14	EC 7866	HE

SCALE DIM. IN MATERIAL

DESIGNED DRAWN CHECKED APPROVED DATE Mar. 24, 1990

PRINTED CIRCUIT CONNECTOR HIGH STAND OFF TYPE

CAT. NO. PHEC...R-S21-H

DRAWING NO. JSC 90752 REV 5

BURNDY JAPAN, Ltd.

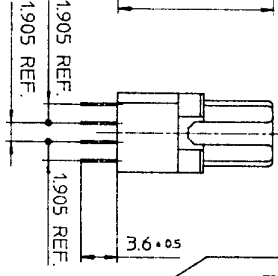
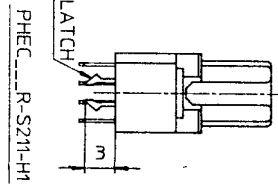
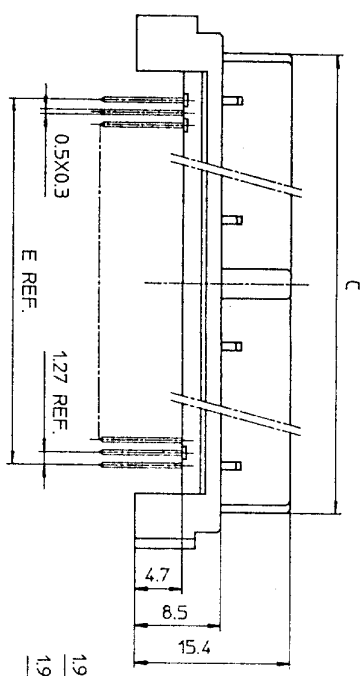
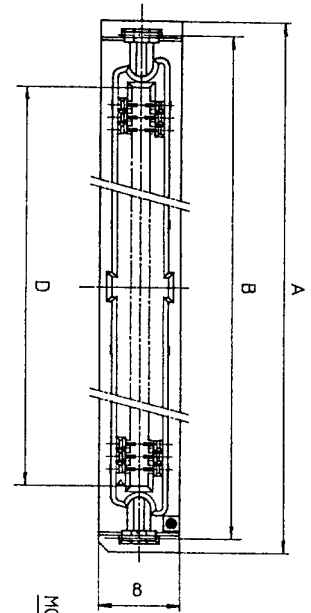

RECOMMENDED PC BOARD
THICKNESS: 1.6 ±0.2
HOLE PATTERN (COMPONENT SIDE)
NO. OF CONTACTS: 40,60,68

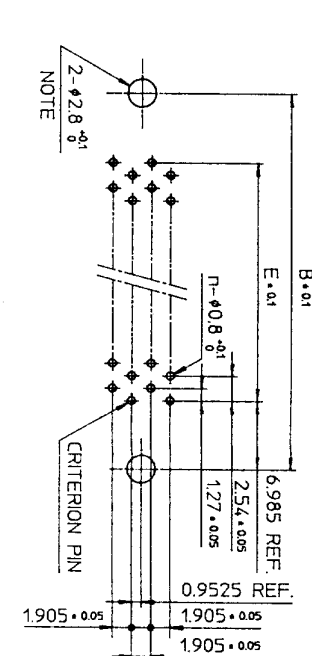

NOTE
THROUGH-HOLES FOR MOUNTING LATCHES ALSO SHOULD BE PLATED.
CRITERION PIN

NO. OF CONTACTS: 40,60,68

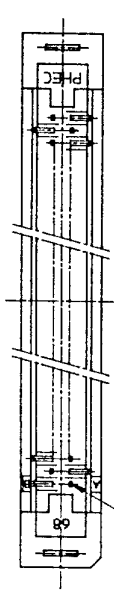

NO. OF CONTACTS: 30,34,50

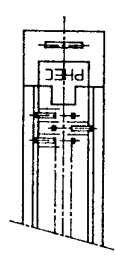

CAT. NO.	NO. OF CONTACTS (MATING SIDE)	DIMENSIONS				
		A	B	C	D	E
PHEC30R-S21-H1	15/ROW X 2 ROWS	34.55	31.75	27.26	21.26	17.78
PHEC34R-S21-H1	17/ROW X 2 ROWS	37.09	34.29	29.8	23.8	20.32
PHEC40R-S21-H1	20/ROW X 2 ROWS	40.9	38.1	33.61	27.61	24.13
PHEC50R-S21-H1	25/ROW X 2 ROWS	47.25	44.45	39.96	33.96	30.48
PHEC60R-S21-H1	30/ROW X 2 ROWS	53.6	50.8	46.31	40.31	36.83
PHEC68R-S21-H1	34/ROW X 2 ROWS	58.68	55.88	51.39	45.39	41.91

TOLERANCES
UNLESS OTHERWISE SPECIFIED: ±0.3

MATERIAL

INSULATOR: PBT RESIN GLASS REINFORCED (UL94V-0)
COLOR: BLACK
CONTACT: PHOSPHOR BRONZE
MOUNTING LATCH: PHOSPHOR BRONZE
SOLDER PLATED

CONTACT PLATING TABLE
(THICKNESS: μm)

CONTACT AREA	REMAINDER
GOLD 0.25 MIN. OVER NICKEL 3.2	SOLDER OVER NICKEL

DRAWING NO. JSC 91840

PRINTED CIRCUIT CONNECTOR
HIGH STAND OFF TYPE
CAT. NO. PHEC_R-S21-H1
DRAWING NO. JSC 91840
REV. 1
BURNDY JAPAN, Ltd.

DESIGNED
DRAWN *M. Oba*
CHECKED A. Matsuo
APPROVED *S. Ito*
DATE Aug. 17, 1992

SCALE
DIM IN mm
MATERIAL

REV	DATE	DESCRIPTION	CKD
1	93	WRONG CONTACT DIM. CORRECTED.	
2	93		

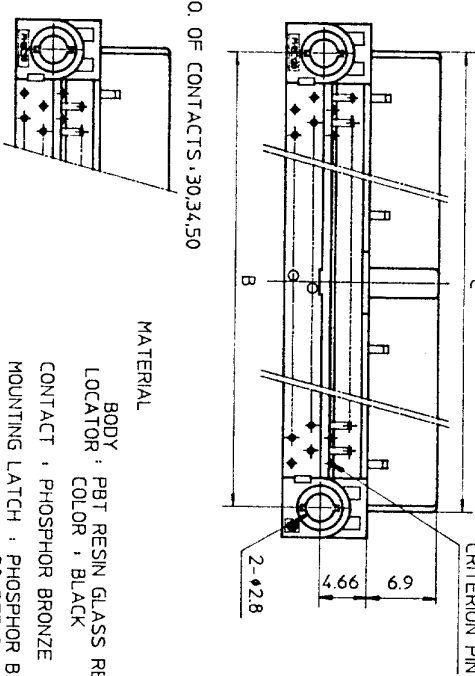
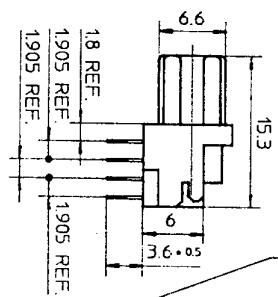
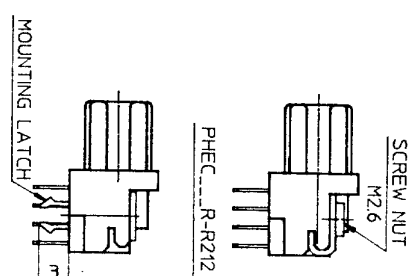
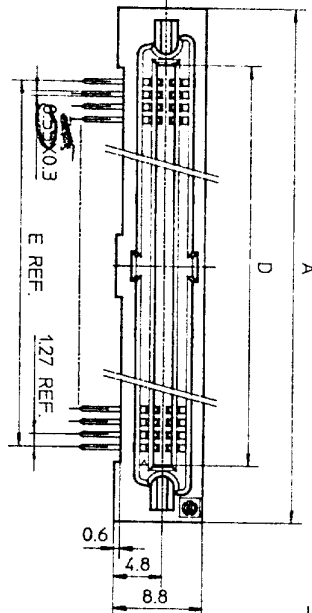
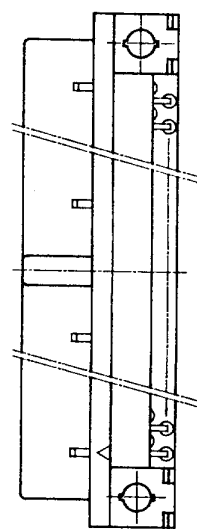

CAT. NO.	NO. OF CONTACTS (MATING SIDE)	DIMENSIONS				
		A	B	C	D	E
PHEC30R-R21	15/ROW X 2 ROWS	32.67	26.67	27.26	21.26	17.78
PHEC34R-R21	17/ROW X 2 ROWS	35.21	29.21	29.8	23.8	20.32
PHEC40R-R21	20/ROW X 2 ROWS	39.02	33.02	33.61	27.61	24.13
PHEC50R-R21	25/ROW X 2 ROWS	45.37	39.37	39.96	33.96	30.48
PHEC60R-R21	30/ROW X 2 ROWS	51.72	45.72	46.31	40.31	36.83
PHEC68R-R21	34/ROW X 2 ROWS	56.8	50.8	51.39	45.39	41.91
PHEC80R-R21	40/ROW X 2 ROWS	64.42	58.42	59.01	53.01	49.53
PHEC100R-R21	50/ROW X 2 ROWS	77.12	71.12	71.71	65.71	62.23
PHEC120R-R21	60/ROW X 2 ROWS	89.82	83.82	84.41	78.41	74.93

CONTACT PLATING TABLE
(THICKNESS: μm)

CONTACT AREA	REMAINDER
GOLD 0.25 MIN.	SOLDER
OVER NICKEL 3.2	OVER NICKEL

RECOMMENDED PC BOARD
THICKNESS: 1.6 ±0.2
HOLE PATTERN (COMPONENT SIDE)
NO. OF CONTACTS: 40,60,68,80,
100,120

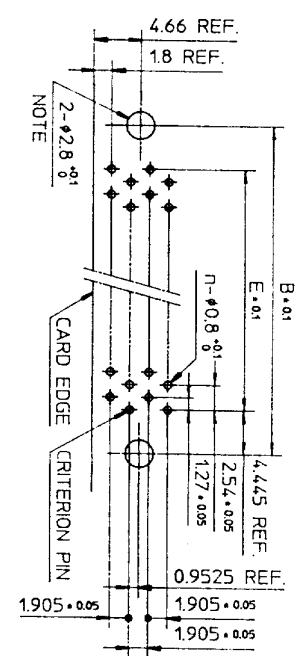

NOTE
THROUGH-HOLES FOR MOUNTING LATCHES ALSO SHOULD BE PLATED.
TOLERANCES UNLESS OTHERWISE SPECIFIED: ±0.3

DRAWING NO.
JSC 90738

NO. OF CONTACTS: 30,34,50
MATERIAL
BODY: PBT RESIN GLASS REINFORCED (UL94V-0)
LOCATOR COLOR: BLACK
CONTACT: PHOSPHOR BRONZE
MOUNTING LATCH: PHOSPHOR BRONZE
SCREW NUT: STEEL
NICKEL PLATED

REV. DATE	DESCRIPTION	CKD	SCALE	DESIGNED	PRINTED CIRCUIT CONNECTOR
3 82-11	30,34,50,68 POSITIONS ADDED.	1.2	DIM. IN mm	M. Osa	CAT. NO. PHEC...R-R21
2 90-6-8	EC 7866	2.0	MATERIAL	CHECKED 4. Ely	DRAWING NO. JSC 90738
1 90-4-20	EC 7837	2.0		APPROVED J. Tomiyama	REV. 3
REFERENCE				DATE Mar. 8, 1990	BURNDY JAPAN, Ltd.