

AMPLIMITE .050 Series Plug Assemblies Unshielded for .025 [0.64] Centerline Ribbon Cable, Series III

Plug Assembly

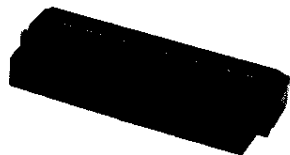

Materials:

Housing and Termination

Covers—Thermoplastic, 94V-0 rated, black

Contacts—Phosphor bronze, duplex plated .000030 [0.00076] min. gold on mating end, bright tin-lead on termination end, all over nickel underplating

Recommended wire size—

.025 [0.64] centerline, 30 AWG [0.05mm²] solid or 7 strand, PVC, flat ribbon cable.

Note: Cable must be approved by Tyco Electronics Engineering.

Technical Documents for 786090-7 only:

Product Specifications—108-1359

Application Specifications—114-40049

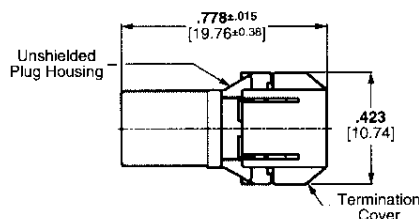
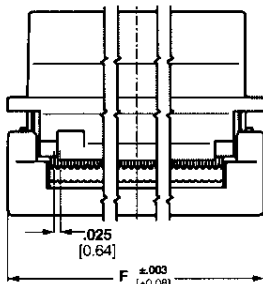
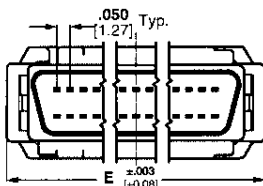

No. of Pos.	Dimensions		Part No.
	E	F	
50	1.578 40.07	1.578 40.07	390377-5 ¹
68	2.029 51.54	2.023 51.30	786090-7

Note: Termination Tooling: Manual Arbor Press Part No. 91085-2 or Pneumatic Press Part No. 91112-3, Universal Base Tool Part No. 768338-4, and Connector Specific Kit Part No. 679235-2. Refer to page 29

¹ Accepts 32 AWG Flat Ribbon Cable. Selection of compatible ribbon cable is the responsibility of the user.

Note: Refer to Tyco Electronics Customer drawings and Application Spec for PCB & panel layouts.

Backshell Kit for 786090-7 .025 [0.64] & Unshielded Plug

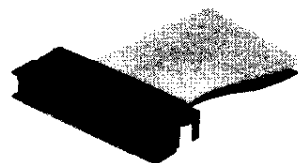

Materials:

Backshell—Thermoplastic, 94V-0 rated, black

Spring Latches—Stainless steel

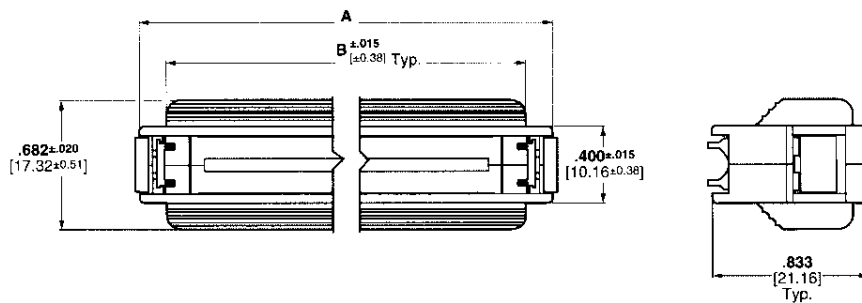

No. of Pos.	Kit Part No.	Dimension	
		A	B
68	787032-7	2.415 [61.34]	2.125 [53.48]

Strain Relief for 786090-7 .025 [0.64] & Unshielded Plug

68-Position
Part No. 787043-7

Materials:

Thermoplastic, 94V-0 rated, black

Note: Pull tab Part No. 88450-8 can be used with this strain relief. Must be ordered separately.

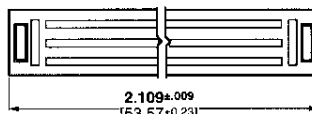
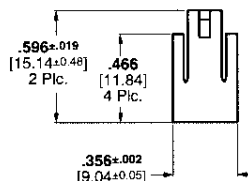
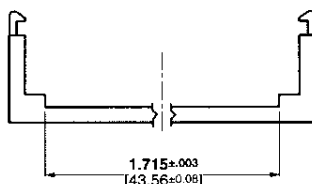

AMPLIMITE .050 Series Connectors, Series III