

NO. OF CONTACTS : 40,60,68,80,100,120
CRITERION PIN

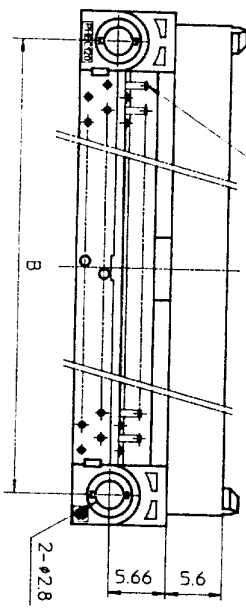

NO. OF CONTACTS : 30,34,50

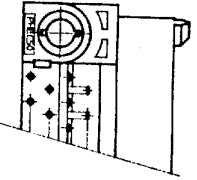

DRAWING NO.
JSC 90736

RECOMMENDED PC BOARD
THICKNESS : 1.6 ± 0.2
HOLE PATTERN (COMPONENT SIDE)

NO. OF CONTACTS : 40,60,68,80,100,120

n : NO. OF CONTACTS

TOLERANCES
UNLESS OTHERWISE SPECIFIED : ± 0.3

CAT. NO.	NO. OF CONTACTS (MATING SIDE)	DIMENSIONS				
		A	B	C	D	E
PHEC30P-R21	15/ROW X 2 ROWS	32.67	26.67	30.3	20.42	17.78
PHEC34P-R21	17/ROW X 2 ROWS	35.21	29.21	32.84	22.96	20.32
PHEC40P-R21	20/ROW X 2 ROWS	39.02	33.02	36.65	26.77	24.13
PHEC50P-R21	25/ROW X 2 ROWS	45.37	39.37	43	33.12	30.48
PHEC60P-R21	30/ROW X 2 ROWS	51.72	45.72	49.35	39.47	36.83
PHEC68P-R21	34/ROW X 2 ROWS	56.8	50.8	54.43	44.55	41.91
PHEC80P-R21	40/ROW X 2 ROWS	64.42	58.42	62.05	52.17	49.53
PHEC100P-R21	50/ROW X 2 ROWS	77.12	71.12	74.75	64.87	62.23
PHEC120P-R21	60/ROW X 2 ROWS	89.82	83.82	87.45	77.57	74.93

MATERIAL : NYLON RESIN GLASS REINFORCED (UL94V-0)
BODY : BLACK
LOCATOR : PBT RESIN GLASS REINFORCED (UL94V-0)
COLOR : BLACK

CONTACT : COPPER ALLOY
MOUNTING LATCH : PHOSPHOR BRONZE
SCREW NUT : STEEL
NICKEL PLATED

CONTACT PLATING TABLE
(THICKNESS : μm)

CONTACT AREA	REMAINDER
GOLD 0.25 MIN. OVER NICKEL 3Z	SOLDER OVER NICKEL

REV	DATE	DESCRIPTION	CKD	SCALE	DIM. IN	MATERIAL	DESIGNED	DRAWN	CHECKED	APPROVED	DATE	CAT. NO.	DRAWING NO.	REV
92	8-14	30,34,50,68 POSITIONS ADDED. LOCATOR MATERIAL ADDED.										PHEC__P-R21	JSC 90736	3
2	6-7	EC 7866												
1	4-20	EC 7837												

PRINTED CIRCUIT CONNECTOR

CAT. NO. PHEC__P-R21

DRAWING NO. JSC 90736

REV 3

BURNDY
JAPAN Ltd.

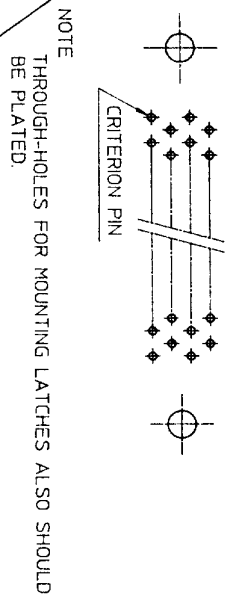
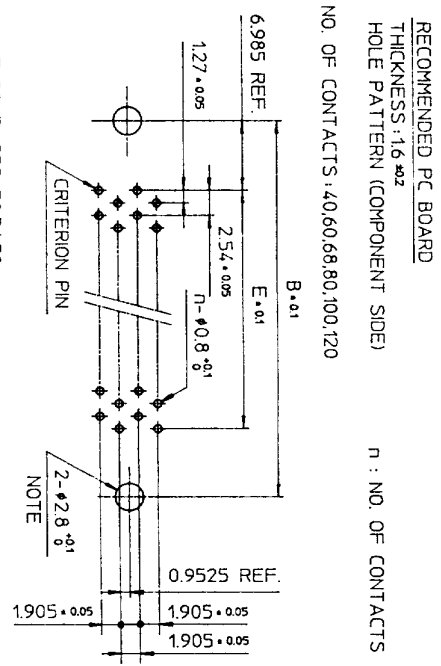
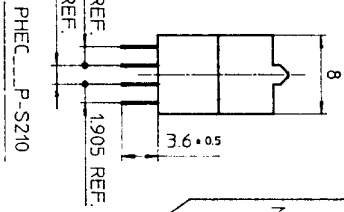
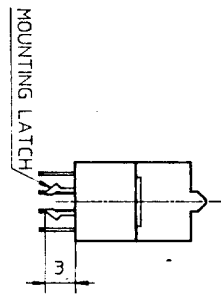
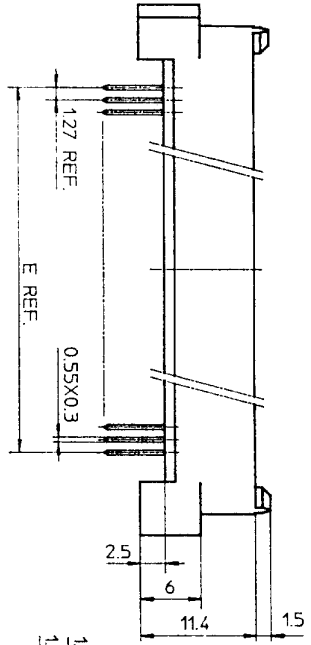
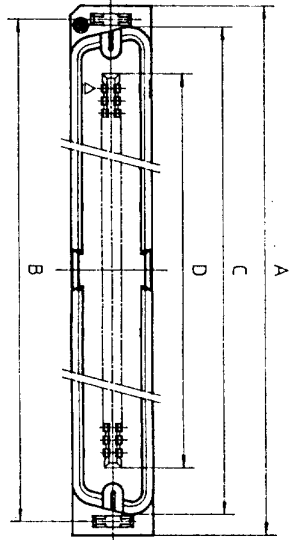

TOLERANCES UNLESS OTHERWISE SPECIFIED: ±0.3

NO. OF CONTACTS: 40,60,68,80,100,120

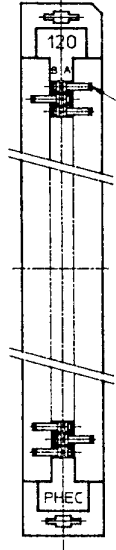

NO. OF CONTACTS: 30,34,50

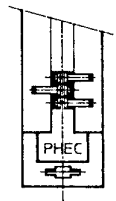

MATERIAL

INSULATOR : NYLON RESIN GLASS REINFORCED (UL94V-0)
 COLOR : BLACK
 CONTACT : COPPER ALLOY
 MOUNTING LATCH : PHOSPHOR BRONZE
 SOLDER PLATED

CAT. NO.	NO. OF CONTACTS (MATING SIDE)	DIMENSIONS				
		A	B	C	D	E
PHEC30P-S21L	15/ROW X 2 ROWS	34.55	31.75	30.3	20.42	17.78
PHEC34P-S21L	17/ROW X 2 ROWS	37.09	34.29	32.84	22.96	20.32
PHEC40P-S21L	20/ROW X 2 ROWS	40.9	38.1	36.65	26.77	24.13
PHEC50P-S21L	25/ROW X 2 ROWS	47.25	44.45	43	33.12	30.48
PHEC60P-S21L	30/ROW X 2 ROWS	53.6	50.8	49.35	39.47	36.83
PHEC68P-S21L	34/ROW X 2 ROWS	58.68	55.88	54.43	44.55	41.91
PHEC80P-S21L	40/ROW X 2 ROWS	66.3	63.5	62.05	52.17	49.53
PHEC100P-S21L	50/ROW X 2 ROWS	79.0	76.2	74.75	64.87	62.23
PHEC120P-S21L	60/ROW X 2 ROWS	91.7	88.9	87.45	77.57	74.93

CONTACT PLATING TABLE [THICKNESS: μm]

CONTACT AREA	REMAINDER
GOLD 0.25 MIN	SOLDER
OVER NICKEL 3.2 OVER NICKEL	

PRINTED CIRCUIT CONNECTOR
 CAT. NO. PHEC_P-S21L
 DRAWING NO. JSC 90735
 REV. 3
BURNDY JAPAN, Ltd.

DESIGNED
 DRAWN *M. Oba*
 CHECKED *A. Eb*
 APPROVED *J. Nakagishi*
 DATE Mar. 8, 1990

SCALE
 DIM. IN mm
 MATERIAL

REV.	DATE	DESCRIPTION	CHKD.
3	'92-8-11	30,34,50,68 POSITIONS ADDED.	<i>M. Oba</i>
2	'90-6-5	EC 7866	<i>M. Oba</i>
1	'90-4-20	EC 7837	<i>M. Oba</i>

DRAWING NO. JSC 90735

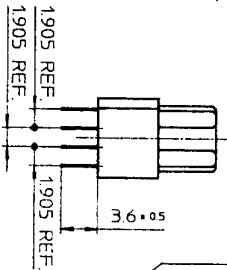
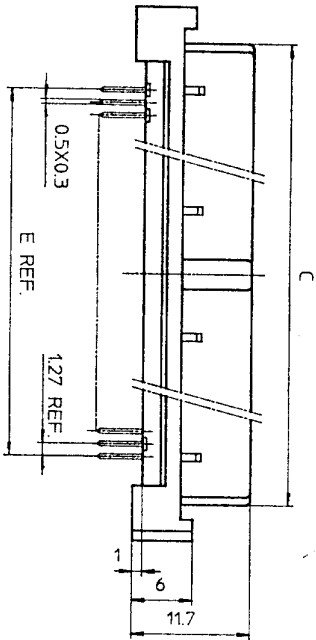
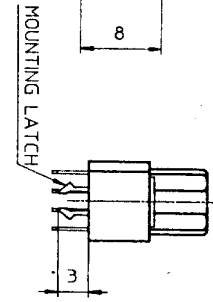
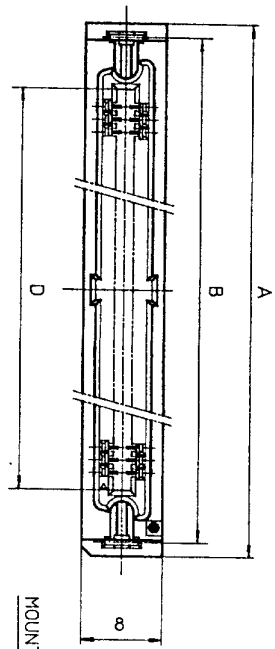

PHEC...R-S210

RECOMMENDED PC BOARD
THICKNESS: 1.6 ± 0.2
HOLE PATTERN (COMPONENT SIDE)
NO. OF CONTACTS: 40, 60, 68, 80, 100, 120
n : NO. OF CONTACTS

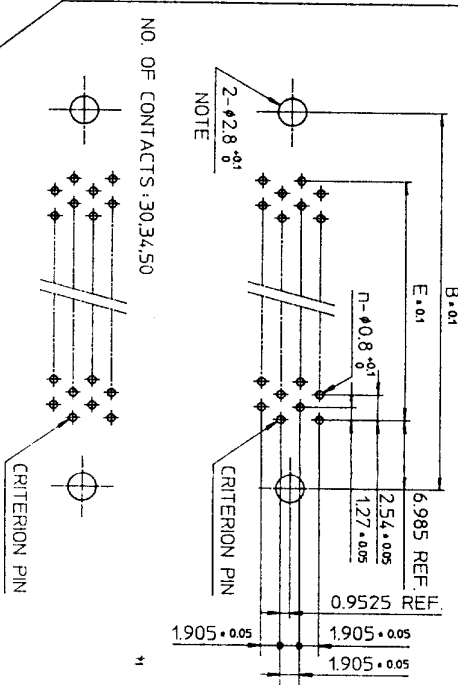

NOTE
THROUGH-HOLES FOR MOUNTING LATCHES ALSO SHOULD BE PLATED.

TOLERANCES
UNLESS OTHERWISE SPECIFIED: ± 0.3

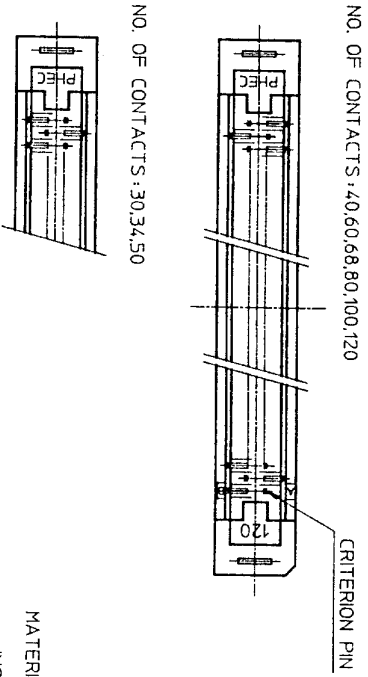

CAT. NO.	NO. OF CONTACTS (MATING SIDE)	DIMENSIONS				
		A	B	C	D	E
PHEC30R-S21	15/ROW X 2 ROWS	34.55	31.75	27.26	21.26	17.78
PHEC34R-S21	17/ROW X 2 ROWS	37.09	34.29	29.8	23.8	20.32
PHEC40R-S21	20/ROW X 2 ROWS	40.9	38.1	33.61	27.61	24.13
PHEC50R-S21	25/ROW X 2 ROWS	47.25	44.45	39.96	33.96	30.48
PHEC60R-S21	30/ROW X 2 ROWS	53.6	50.8	46.31	40.31	36.83
PHEC68R-S21	34/ROW X 2 ROWS	58.68	55.88	51.39	45.39	41.91
PHEC80R-S21	40/ROW X 2 ROWS	66.3	63.5	59.01	53.01	49.53
PHEC100R-S21	50/ROW X 2 ROWS	79.0	76.2	71.71	65.71	62.23
PHEC120R-S21	60/ROW X 2 ROWS	91.7	88.9	84.41	78.41	74.93

CONTACT PLATING TABLE

MATERIAL
INSULATOR: PBT RESIN GLASS REINFORCED (UL-94V-0)
COLOR: BLACK

CONTACT: PHOSPHOR BRONZE
MOUNTING LATCH: PHOSPHOR BRONZE
SOLDER PLATED

CONTACT AREA	REMAINDER
GOLD 0.25 MIN. OVER NICKEL 3.2	SOLDER OVER NICKEL

DRAWING NO. JSC 90737

PRINTED CIRCUIT CONNECTOR
CAT. NO. PHEC...R-S21
DRAWING NO. JSC 90737
REV 4
BURNDY JAPAN, Ltd.

DESIGNED
DRAWN M. Oba
CHECKED
APPROVED J. Nakagishi
DATE Mar. 8, 1990

SCALE
DIM IN MM
MATERIAL

REV. DATE	DESCRIPTION	CKD
4-1-29	WRONG CONTACT DIM. CORRECTED.	
3-8-11	30,34,50,68 POSITIONS ADDED No. S.P.	
2-5-30	EC 7866 No. JK	
1-4-20	EC 7837 No. JK	

DRAWING NO.
JSC 90739

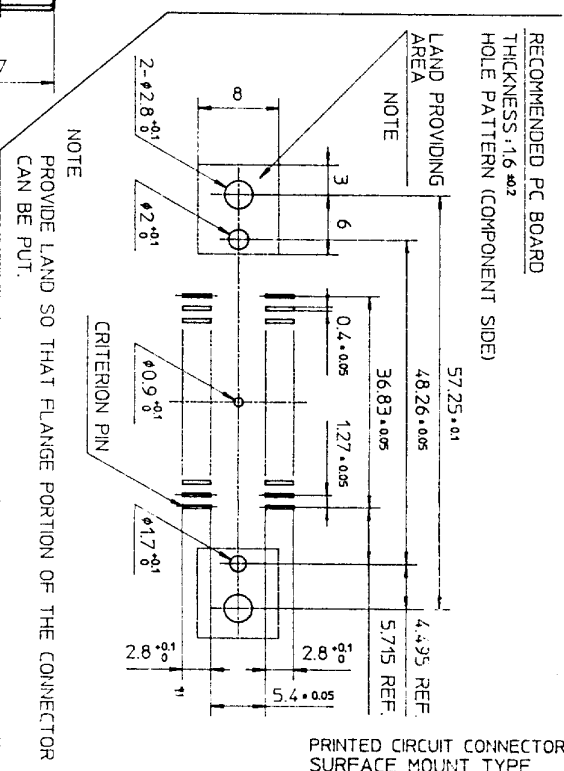
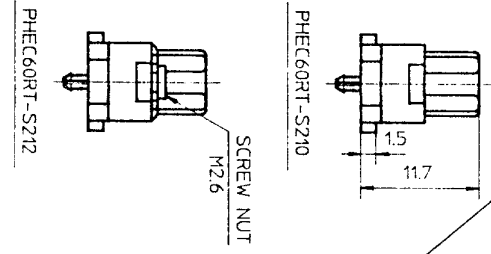
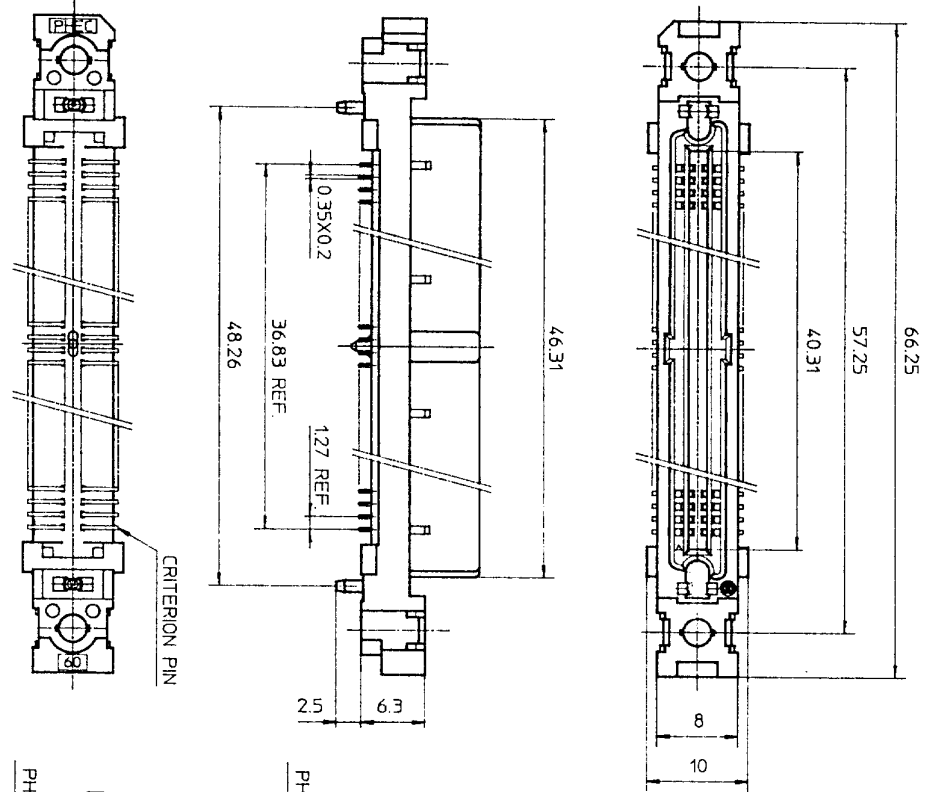

MATERIAL
INSULATOR : PPS RESIN GLASS REINFORCED (UL94V-0)
COLOR : BLACK
CONTACT : PHOSPHOR BRONZE
SCREW NUT : STAINLESS
NO. OF CONTACTS : 30/ROW X 2 ROWS (MATING SIDE)

CONTACT PLATING TABLE
(THICKNESS : μm)

CONTACT AREA	REMAINDER
GOLD 0.25 MIN.	SOLDER
OVER NICKEL 3Z	OVER NICKEL

TOLERANCES
UNLESS OTHERWISE SPECIFIED : ± 0.3

PRINTED CIRCUIT CONNECTOR
SURFACE MOUNT TYPE

REV	DATE	DESCRIPTION	CHK.
4	'92 8-14	WRONG CONTACT DIM. CORRECTED 100 POSITIONS OF DELETED.	M. Oba
3	'92 1-8	DIM. CHANGED.	J. Kobayashi
2	'90 6-8	EC7866	J. Kobayashi
1	'90 4-20	VARIATION ADDED.	J. Kobayashi

SCALE	1:1
DIM IN	MM
MATERIAL	

DESIGNED	
DRAWN	M. Oba
CHECKED	J. Kobayashi
APPROVED	J. Kobayashi
DATE	Mar. 8, 1990

CAT. NO.	PHEC60RT-S212
DRAWING NO.	JSC 90739
REV	4

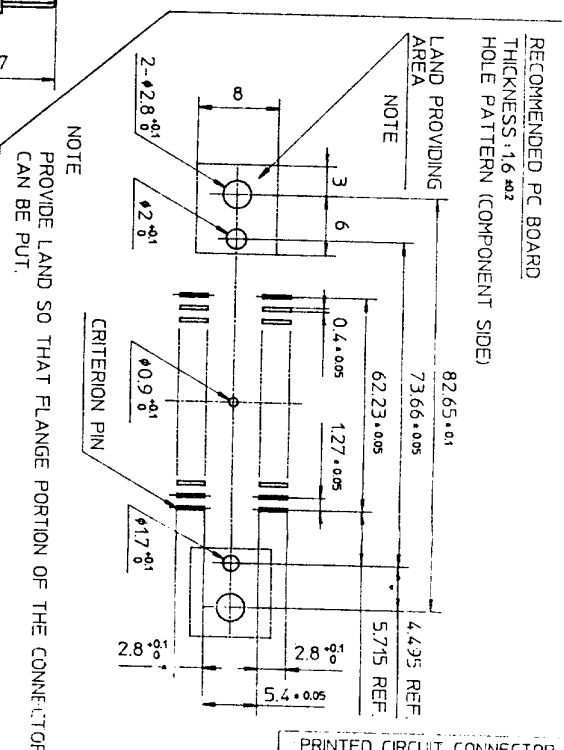
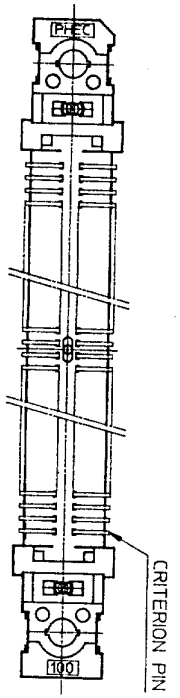
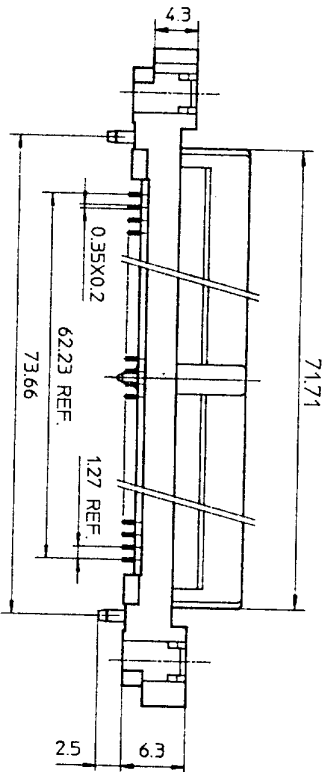
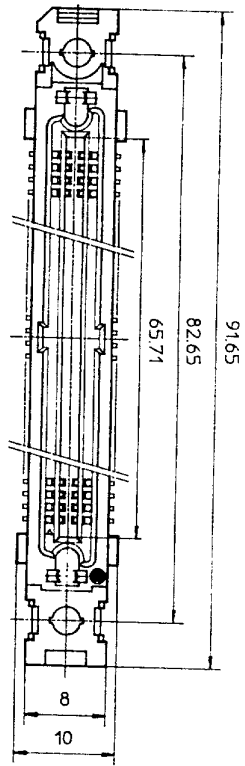

RECOMMENDED PC BOARD THICKNESS: 1.6 ±0.2 HOLE PATTERN (COMPONENT SIDE)

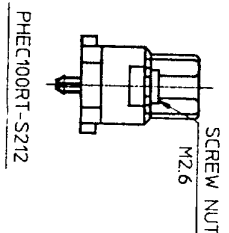
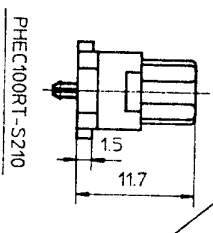

TOLERANCES UNLESS OTHERWISE SPECIFIED: ±0.3

MATERIAL
 INSULATOR : PPS RESIN GLASS REINFORCED (UL94V-0)
 COLOR : BLACK
 CONTACT : PHOSPHOR BRONZE
 SCREW NUT : STAINLESS
 NO. OF CONTACTS : 50/ROW X 2 ROWS (MATING SIDE)

CONTACT PLATING TABLE (THICKNESS: μm)

CONTACT AREA	REMAINDER
GOLD 0.25 MIN OVER NICKEL 3.2	SOLDER OVER NICKEL

PRINTED CIRCUIT CONNECTOR SURFACE MOUNT TYPE

CAT. NO. PHEC100RT-S21L

DRAWING NO. JSC 91839 REV. 0

BURNDY JAPAN Ltd.

DESIGNED BY
 DRAWN BY
 CHECKED BY
 APPROVED BY
 DATE Aug. 11, 1992

SCALE
 DIM. IN mm
 MATERIAL

REV.	DATE	DESCRIPTION	CHKD.

DRAWING NO. JSC 91839

DRAWING NO. JSC 90752

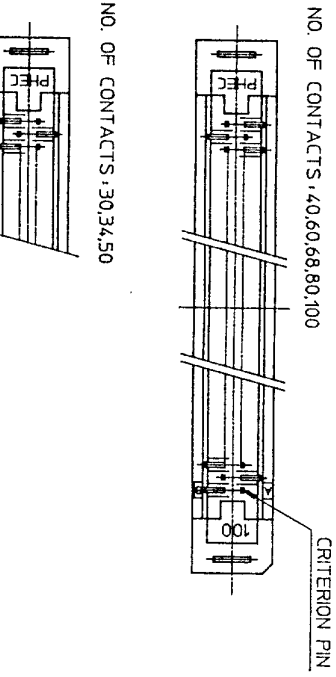
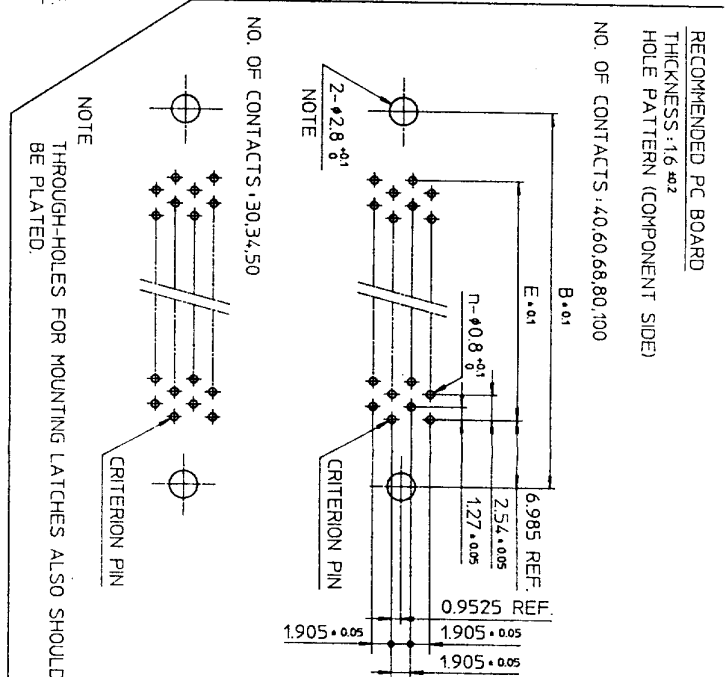
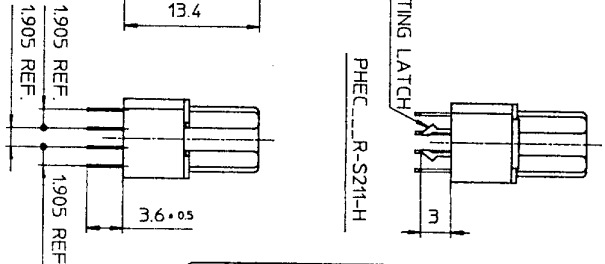
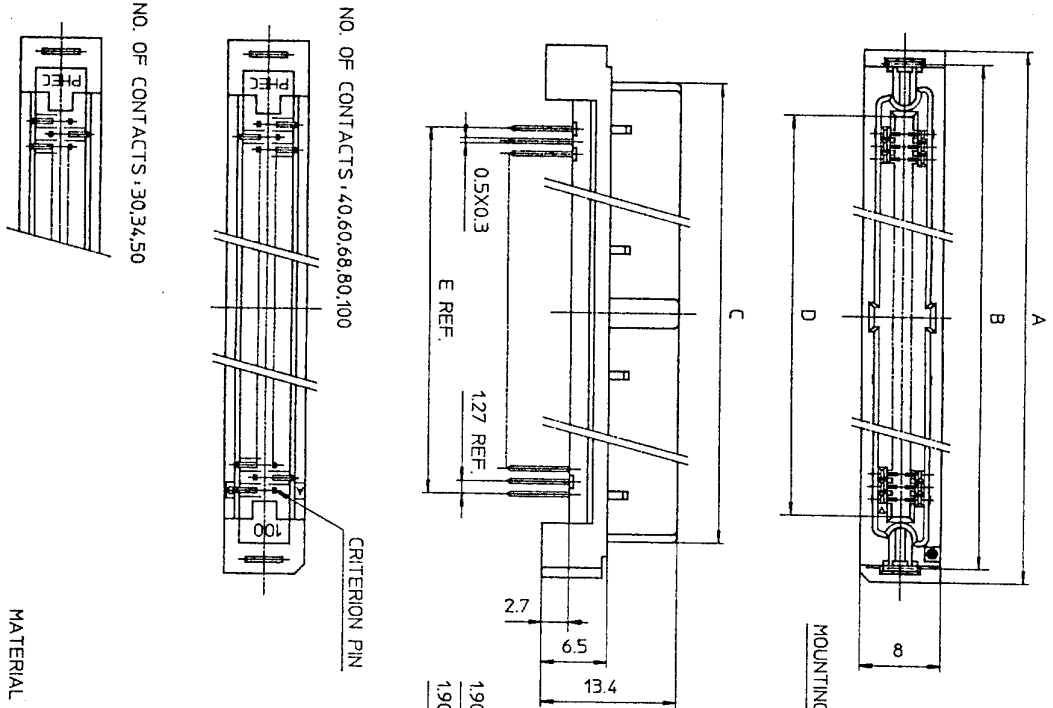

CAT. NO.	NO. OF CONTACTS (MATING SIDE)	DIMENSIONS				
		A	B	C	D	E
PHEC30R-S21-H	15/ROW X 2 ROWS	34.55	31.75	27.26	21.26	17.78
PHEC34R-S21-H	17/ROW X 2 ROWS	37.09	34.29	29.8	23.8	20.32
PHEC40R-S21-H	20/ROW X 2 ROWS	40.9	38.1	33.61	27.61	24.13
PHEC50R-S21-H	25/ROW X 2 ROWS	47.25	44.45	39.96	33.96	30.48
PHEC60R-S21-H	30/ROW X 2 ROWS	53.6	50.8	46.31	40.31	36.83
PHEC68R-S21-H	34/ROW X 2 ROWS	58.68	55.88	51.39	45.39	41.91
PHEC80R-S21-H	40/ROW X 2 ROWS	66.3	63.5	59.01	53.01	49.53
PHEC100R-S21-H	50/ROW X 2 ROWS	79.0	76.2	71.71	65.71	62.23

MATERIAL

INSULATOR: PBT RESIN GLASS REINFORCED (UL94V-0)

COLOR: BLACK

CONTACT: PHOSPHOR BRONZE

MOUNTING LATCH: PHOSPHOR BRONZE
SOLDER PLATED

CONTACT PLATING TABLE

CONTACT AREA	REMAINDER
GOLD 0.25 MIN	SOLDER
OVER NICKEL 3.2	OVER NICKEL

TOLERANCES UNLESS OTHERWISE SPECIFIED: ±0.3

NOTE THROUGH-HOLES FOR MOUNTING LATCHES ALSO SHOULD BE PLATED.

REV	DATE	DESCRIPTION	CHKD.
5	93-6-22	100 POSITIONS ADDED.	M.O
4	93-2-1	WRONG CONTACT DIM. CORRECTED.	5.9
3	92-8-11	100,120 POSITIONS DELETED. 30,34,50,68 POSITIONS ADDED.	5.9
2	90-5-30	DIM. CHANGED (36.61 → 33.61)	5.9
1	90-5-14	EC 7866	HE

SCALE DIM. IN MATERIAL

DESIGNED
DRAWN M. Oga
CHECKED
APPROVED
DATE Mar. 24, 1990

PRINTED CIRCUIT CONNECTOR HIGH STAND OFF TYPE

CAT. NO. PHEC...R-S21-H

DRAWING NO. JSC 90752 REV 5

BURNDY JAPAN, Ltd.

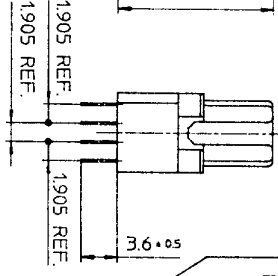
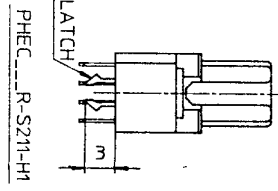
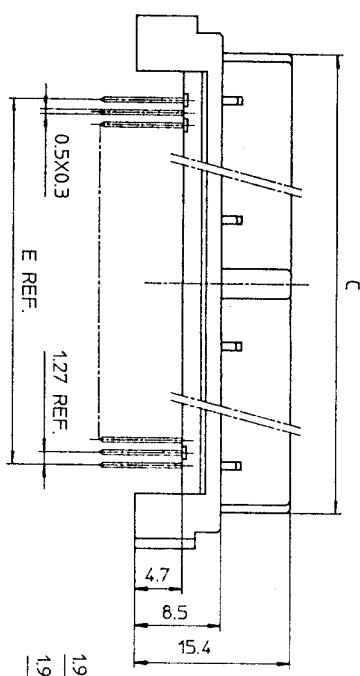
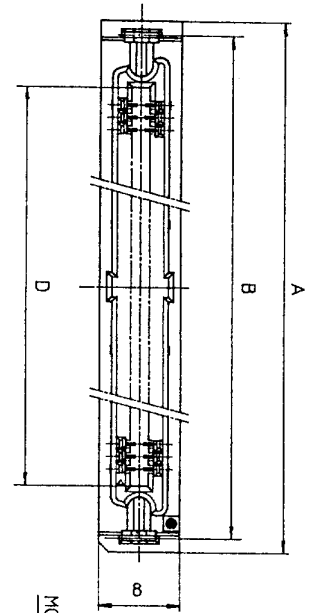

RECOMMENDED PC BOARD
THICKNESS: 1.6 ± 0.2
HOLE PATTERN (COMPONENT SIDE)
NO. OF CONTACTS: 40,60,68

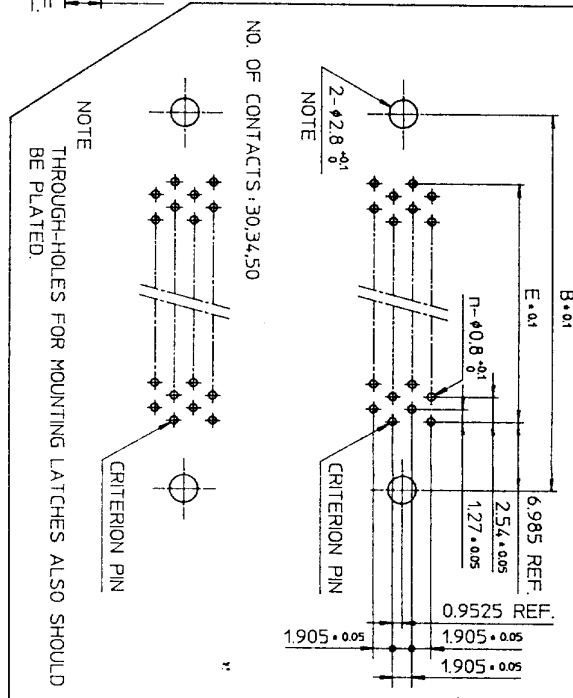

NO. OF CONTACTS: 40,60,68

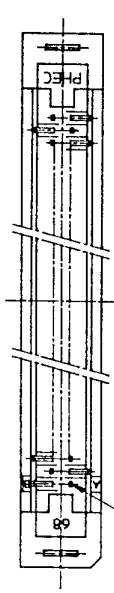

NO. OF CONTACTS: 30,34,50

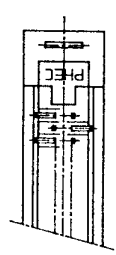

CAT. NO.	NO. OF CONTACTS (MATING SIDE)	DIMENSIONS				
		A	B	C	D	E
PHEC30R-S21-H1	15/ROW X 2 ROWS	34.55	31.75	27.26	21.26	17.78
PHEC34R-S21-H1	17/ROW X 2 ROWS	37.09	34.29	29.8	23.8	20.32
PHEC40R-S21-H1	20/ROW X 2 ROWS	40.9	38.1	33.61	27.61	24.13
PHEC50R-S21-H1	25/ROW X 2 ROWS	47.25	44.45	39.96	33.96	30.48
PHEC60R-S21-H1	30/ROW X 2 ROWS	53.6	50.8	46.31	40.31	36.83
PHEC68R-S21-H1	34/ROW X 2 ROWS	58.68	55.88	51.39	45.39	41.91

TOLERANCES
UNLESS OTHERWISE SPECIFIED: ±0.3

MATERIAL

INSULATOR: PBT RESIN GLASS REINFORCED (UL94V-0)
COLOR: BLACK
CONTACT: PHOSPHOR BRONZE
MOUNTING LATCH: PHOSPHOR BRONZE
SOLDER PLATED

CONTACT PLATING TABLE
(THICKNESS: μm)

CONTACT AREA	REMAINDER
GOLD 0.25 MIN. OVER NICKEL 3.2	SOLDER OVER NICKEL

DRAWING NO. JSC 91840

PRINTED CIRCUIT CONNECTOR
HIGH STAND OFF TYPE
CAT. NO. PHEC__R-S21-H1
DRAWING NO. JSC 91840
REV. 1
BURNDY JAPAN, Ltd.

DESIGNED
DRAWN *M. Oba*
CHECKED A. matsuo
APPROVED *S. Ito*
DATE Aug. 17, 1992

SCALE 1:1
DIM IN mm
MATERIAL
WRONG CONTACT DIM. CORRECTED.

REV	DATE	DESCRIPTION	CKD
1	93	WRONG CONTACT DIM. CORRECTED.	
2	93		

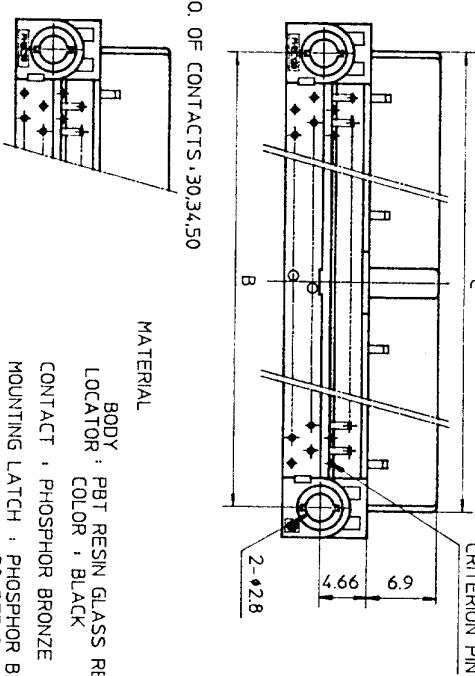
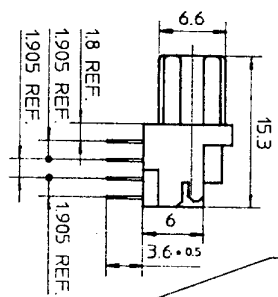
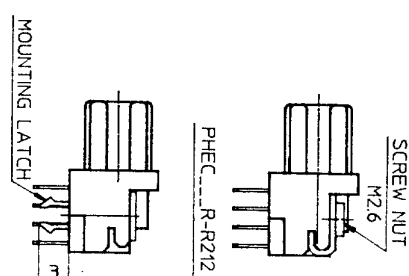
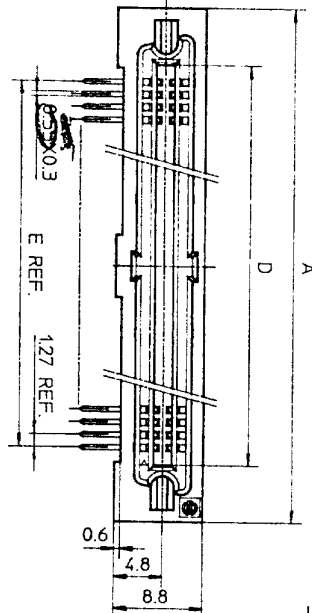
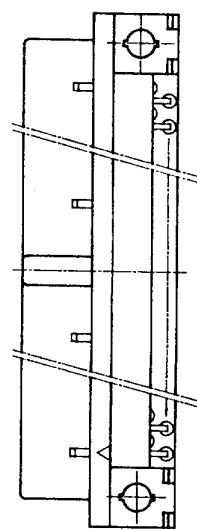

NO. OF CONTACTS: 30,34,50

MATERIAL

BODY : PBT RESIN GLASS REINFORCED (UL94V-0)

LOCATOR COLOR : BLACK

CONTACT : PHOSPHOR BRONZE

MOUNTING LATCH : PHOSPHOR BRONZE

SCREW NUT : STEEL

NICKEL PLATED

DRAWING NO. JSC 90738

RECOMMENDED PC BOARD THICKNESS: 1.6 ±0.2

HOLE PATTERN (COMPONENT SIDE)

NO. OF CONTACTS: 40,60,68,80, 100,120

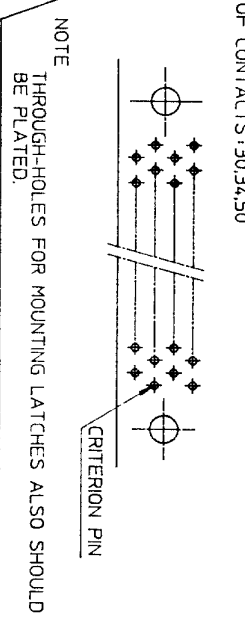
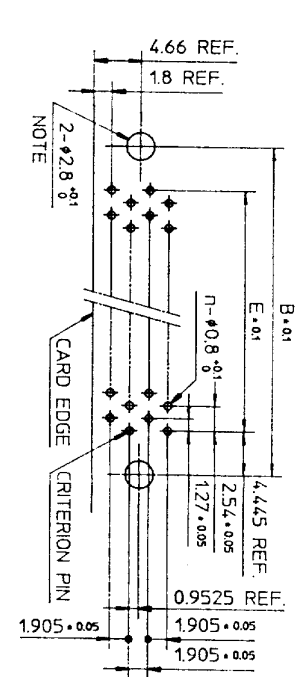

TOLERANCES UNLESS OTHERWISE SPECIFIED: ±0.3

CAT. NO.	NO. OF CONTACTS (MATING SIDE)	DIMENSIONS				
		A	B	C	D	E
PHEC30R-R21	15/ROW X 2 ROWS	32.67	26.67	27.26	21.26	17.78
PHEC34R-R21	17/ROW X 2 ROWS	35.21	29.21	29.8	23.8	20.32
PHEC40R-R21	20/ROW X 2 ROWS	39.02	33.02	33.61	27.61	24.13
PHEC50R-R21	25/ROW X 2 ROWS	45.37	39.37	39.96	33.96	30.48
PHEC60R-R21	30/ROW X 2 ROWS	51.72	45.72	46.31	40.31	36.83
PHEC68R-R21	34/ROW X 2 ROWS	56.8	50.8	51.39	45.39	41.91
PHEC80R-R21	40/ROW X 2 ROWS	64.42	58.42	59.01	53.01	49.53
PHEC100R-R21	50/ROW X 2 ROWS	77.12	71.12	71.71	65.71	62.23
PHEC120R-R21	60/ROW X 2 ROWS	89.82	83.82	84.41	78.41	74.93

CONTACT PLATING TABLE (THICKNESS: μm)

CONTACT AREA	REMAINDER
GOLD 0.25 MIN.	SOLDER
OVER NICKEL 3.2	OVER NICKEL

REV. DATE	DESCRIPTION	CKD	SCALE	DESIGNED	PRINTED CIRCUIT CONNECTOR
3	30,34,50,68 POSITIONS ADDED.	1.2	DIM. IN mm	M. Osa	CAT. NO. PHEC...R-R21
2	EC 7866	2.0	MATERIAL	CHECKED	DRAWING NO. JSC 90738
1	EC 7837	2.0		APPROVED	REV. 3
REFERENCE				DATE	BURNDY JAPAN, Ltd.