

PRODUCT NO.	OPTIONAL HOLD DOWN CLIP	FINISH PLATING	DUST CAP P/N:
10052369-001LF	SEE DETAIL "L"	SEE NOTE 2A	N/A
10052369-002LF		SEE NOTE 2B	
10052369-002TRLF		SEE NOTE 2A	10075766-001
10052369-003LF		SEE NOTE 2A	
10052369-004LF			

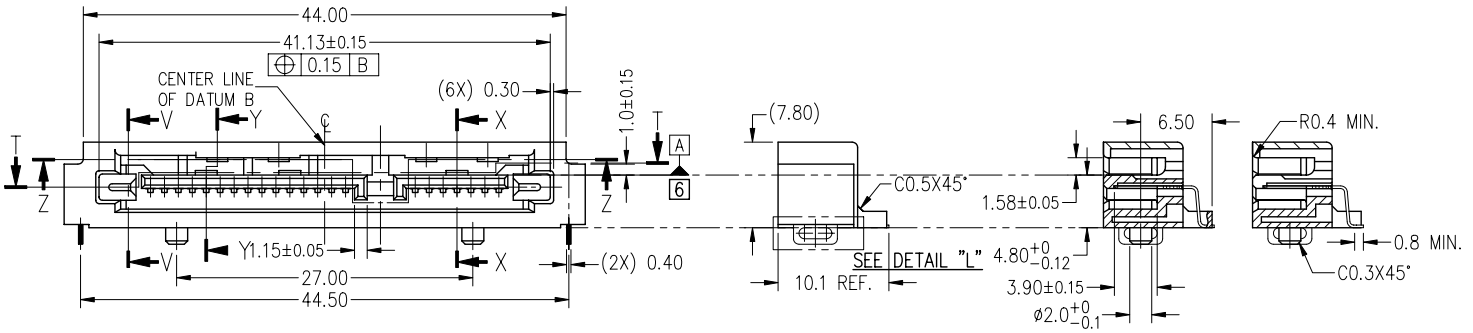
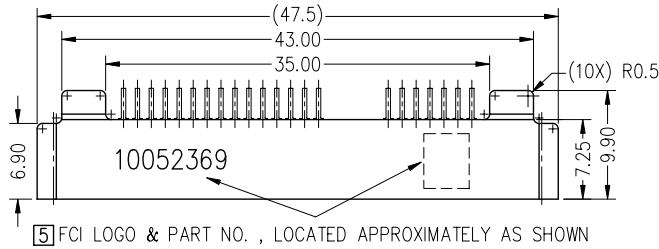

mat'l. code				tolerances unless otherwise specified			projection	product family	
ltr	ecn no	dr	date	angles	linear	mm	SATA PLUG		
A	S05-0219	SLLIM	051017		±.25	mm	title		
B	S05-0323	SLLIM	051109		-----		SATA PLUG, SMT		
C	S06-0118	SLLIM	060117	±3°	-----	scale 2:1	22POS. 4-WALLS		
D	S06-0119	SLLIM	060405	dr	SLLIM		dwg no	sheet 1 of 5	
E	S07-0034	SLLIM	060131	enqr	SLLIM		10052369	A4	
F	S08-0293	SLLIM	080909	chr	SLLIM		type Product Customer Drawing		
				appd	JOEY NG				
sheet index	revision sheet	1	2	3	4	5			

1 | 2 | 3 | 4 | 5 | 6

SECTION "T-T"

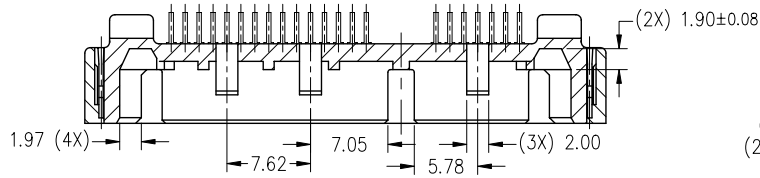

SECTION "Z-Z"
(LATCHING FEATURES)

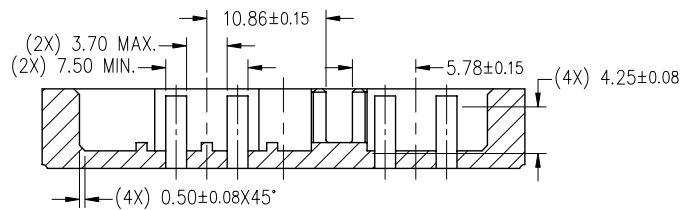

CENTER LINE OF DATUM B

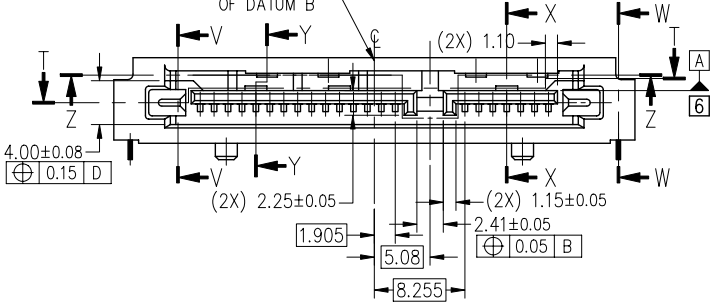

CAVITY NO. APPROXIMATELY AS SHOWN

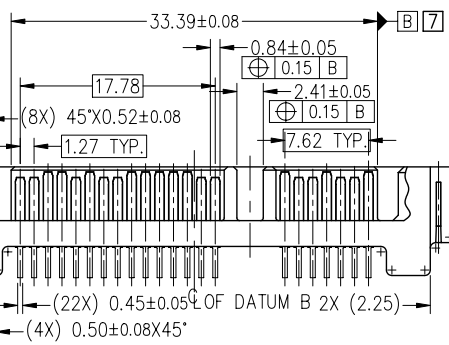
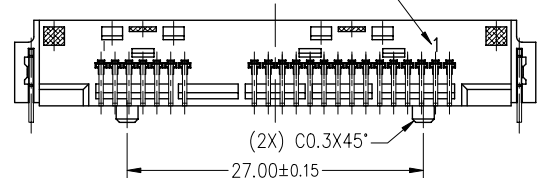

mat'l. code		tolerances unless otherwise specified		projection	product family	
ltr	ecn no	dr	date		SATA PLUG	
F					title	SATA PLUG, SMT
				angles	linear	mm
				±3°	±.25	scale 2:1
				dr	enr	chr
				SLIM	041223	041223
				SLIM	041224	041224
				appd	JOEY NG 041227	
sheet index	revision sheet					
				title		size
				SATA PLUG, SMT		sheet 2 of 5
				22POS. 4-WALLS		A4
				dwg no		10052369
				type		Product Customer Drawing

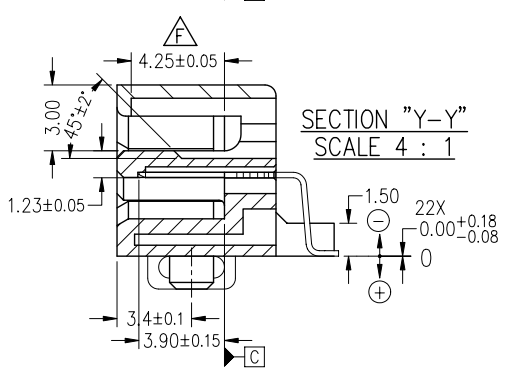
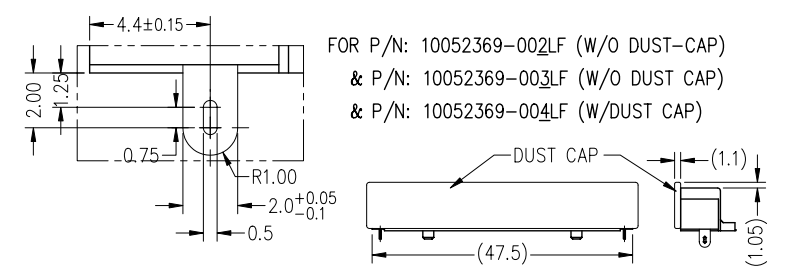
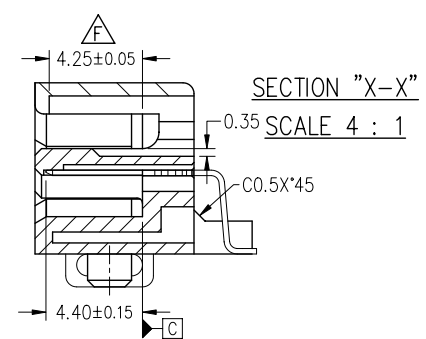
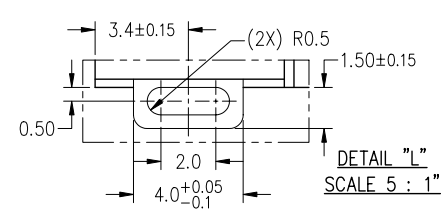
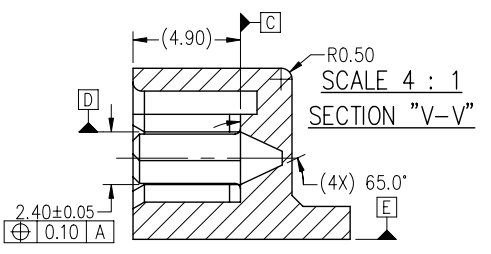

mat'l. code		tolerances unless otherwise specified		projection	product family
ltr	ecn no	dr	date	 mm scale 2:1	SATA PLUG
F					title
			angles		SATA PLUG, SMT
			linear		22POS. 4-WALLS
			±3°		dwg no
			dr		sheet 3 of 5
			enr		size
			chr		10052369
			appd		A4
					type
sheet index	revision sheet				Product Customer Drawing

PDM: Rev:F STATUS:Released Printed: May 01, 2009

FOR P/N: 10052369-002LF, 10052369-002TRLF,
10052369-003LF & 10052369-004LF

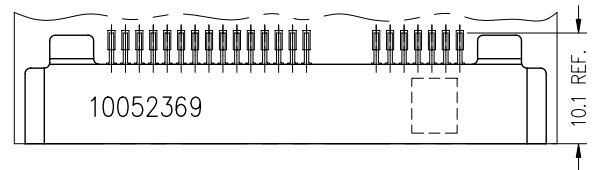
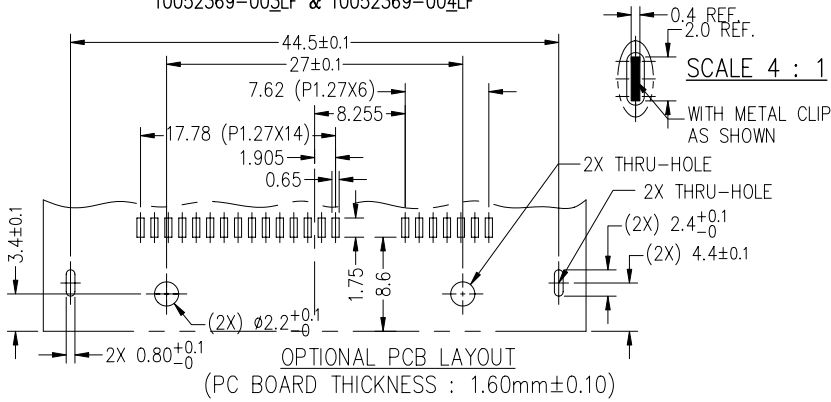

FOR P/N: 10052369-001LF

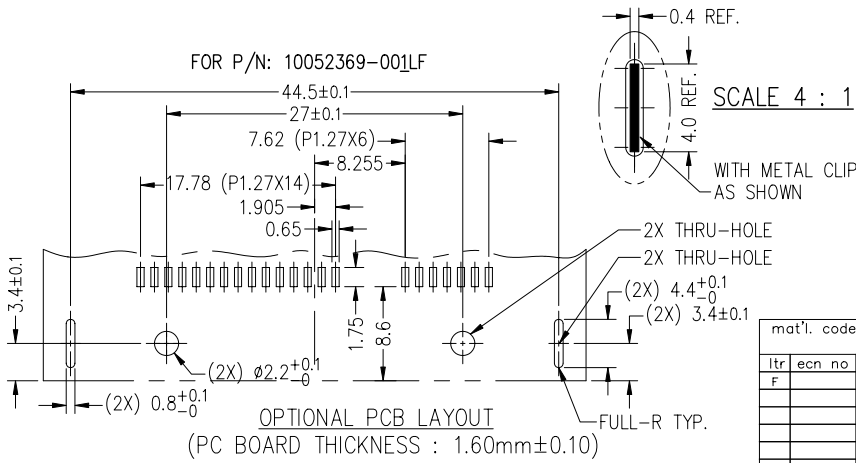

mat'l. code		tolerances unless otherwise specified		projection	product family	
ltr	ecn no	dr	date		SATA PLUG	
F					title	
			angles		SATA PLUG, SMT	
			linear		22POS. 4-WALLS	
			±3°	±.25	dwg no	
			dr	linear	10052369	
			enr	linear	sheet 4 of 5	
			chr	linear	size	
			appd	linear	A4	
			JOEY NG	linear	type	
sheet	revision				Product Customer Drawing	
index	sheet					

NOTES :

1. MATERIALS:

A. HOUSING:

HIGH TEMPERATURE THERMOPLASTIC MATERIAL, UL 94V-0, COLOR; BLACK. MAXIMUM REGRIND MATERIAL IS NOT TO EXCEED 25%. MOLD FLASH SHALL NOT COVER ANY PORTION OF THE MATING CONTACT SURFACE AND SHALL NOT EXCEED 0.15 mm (.006") MAXIMUM AT NON-CRITICAL OR FUNCTIONAL AREAS.

B. CONTACT PIN: COPPER ALLOY (BRASS).

2A. FINISH:

FOR P/N: 10052369-001LF ; P/N: 10052369-002LF ;
AND P/N: 10052369-004LF

SATA SIGNAL & POWER PINS: (MATING SIDE)
1.27um [50u"] MINIMUM, 2.54um [100u"] MAXIMUM NICKEL UNDER PLATE WITH 0.127um [5u"] MINIMUM GOLD IN CONTACT AREA.

2B. FINISH:

FOR P/N: 10052369-003LF
SATA SIGNAL & POWER PINS: (MATING SIDE)
1.27um [50u"] MINIMUM, 2.54um [100u"] MAXIMUM NICKEL UNDER PLATE WITH 0.76um [30u"] MINIMUM GOLD IN CONTACT AREA.

B. ALL SOLDER TAILS:

1.91um [75u"] MINIMUM LEAD-FREE (100%) TIN, PLATING COVERAGE: 95% MINIMUM FOR UNDER AND OVERPLATE.

C. METAL HOLD DOWN CLIPS:

1.91um MINIMUM LEAD-FREE (100%) TIN, PLATING COVERAGE: 95% MINIMUM FOR UNDER AND OVERPLATE.

3. SOLDER TAIL REQUIREMENTS:

ENTIRE DATA PIN IS TO BE PLATED. EXPOSED BASE METAL AT END OF SOLDER TAIL (DUE TO FABRICATION PROCESS) IS ACCEPTABLE. IF SOLDER FABRICATION REQUIRES A SHEARING PROCESS. A SHEAR DIRECTION OF BOTTOM TO TOP OF SOLDER TAIL IS PREFERRED TO ALLOW FOR PLATING WIPE AT THE END OF TAIL.

4. WARPAGE REQUIREMENTS: (BOW AND TWIST)

MAXIMUM WARPAGE 0.15mm OVER THE LENGTH OF THE CONNECTOR. PIN RETENTION FORCE: 1.32LBS (0.6kg) MINIMUM PER PIN.

5. PART MARKING: MANUFACTURE NAME AND / OR LOGO SHALL BE MARKED ON THE SURFACE OF THE CONNECTOR APPROXIMATELY WHERE SHOWN. HEIGHT OF CHARACTERS TO BE MAXIMUM POSSIBLE.

6. [-A-] IS DEFINED AS THE TOP PORTION OF THE NOTED BLADE SURFACE.

7. [-B-] IS DEFINED AS THE CENTERLINE OF THE [33.915] DIMENSION.

8. TYPICAL WALL THICKNESS (1.0 mm).

9. ALTERNATE CORING AND RIB CONSTRUCTION FOR MOLDING PROCESS.

10. PACKAGING - 32 CONNECTOR PER TRAY.

11. THIS PRODUCT MEETS EUROPEAN UNION DIRECTIVES AND OTHER COUNTRY REGULATIONS AS DESCRIBED IN GS-22-008.

12. THE HOUSING WILL WITHSTAND EXPOSURE TO 260°C TEMPERATURE FOR 10 SECONDS IN A CONVECTION, INFRA-RED OR VAPOR PHASE REFLOW OVEN.

13. A Δ SYMBOL WILL BE NEXT TO ANY DIMENSION, VIEW, OR NOTE WHICH HAS BEEN MODIFIED WITH THE CURRENT DRAWING REVISION.

mat'l. code				tolerances unless otherwise specified			projection	product family
ltr	ecn no	dr	date	angles	linear		SATA PLUG	
F				±3'	±.25		mm	title
				dr	SLLIM 041223	scale 2:1	SATA PLUG, SMT	
				enrg	SLLIM 041223		22POS. 4-WALLS	
				chr	SLLIM 041223		dwg no	sheet 5 of 5
				appd	JOEY NG 041227		10052369	size
				sheet index	revision sheet		type	A4
							Product Customer Drawing	