



MMCX COAXIAL CONNECTORS

The Connex MMCX series is the next generation of micro-miniature connectors. Offering a reliable broadband performance from DC to 6 GHz. These 50 ohm connectors incorporate the industry-approved MMCX interface, assuring reliable snap-on/quick-disconnect mating and proven electrical performance. It's low-profile PCB receptacles make this series ideal for high-volume cellular, GPS and wireless base station applications.

ELECTRICAL SPECIFICATIONS

Impedance		50 ohm
Frequency range		0–6 GHz
Working voltage		170 VRMS max. at sea level
Dielectric withstanding voltage		500 VRMS min. at sea level
VSWR	Straight	1.3 max.
	Right angle	1.5 max.
Contact	Center contact	5 milliohms max.
Resistance	Outer conductor	2.5 milliohms max.
Insulator resistance		1000 Megohms min.

Mating engagement compatible with CECC 22340

MATERIAL SPECIFICATIONS

PARTS NAME		MATERIAL	FINISH
Body, Metal parts		Brass per QQ-B-626	Nickel or gold per requirement
Center	Male	Brass per QQ-B-626	Gold plated
Contacts	Female	Beryllium copper, per QQ-C-530	Gold plated
Insulators		PTFE	None
Crimp ferrules		Annealed copper	Nickel or gold per requirement

MECHANICAL SPECIFICATIONS

Engagement force	3.4 lbs max.
Disengagement force	1.4 lbs. – 3.4 lbs.
Contact retention	2.3 lbs. min.
Durability (matings)	500 cycles min.



MMCX COAXIAL CONNECTORS

INTERFACE MATING DIMENSIONS

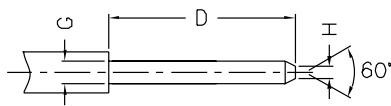
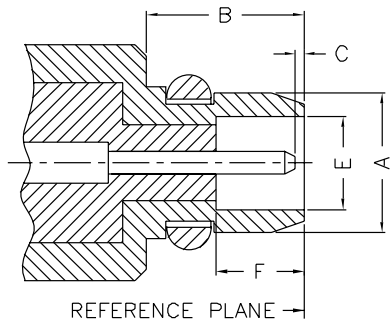

PLUG

Letter	Millimeters [Inches]	
	Minimum	Maximum
A	–	2.40 [.095]
B	2.70 [.106]	–
C	0.00	0.25 [.010]
D	–	3.15 [.124]
E	1.58 [.062]	1.62 [.064]
F	1.45 [.057]	–
G	0.38 [.150]	0.42 [.017]
H	–	0.20 [.008]

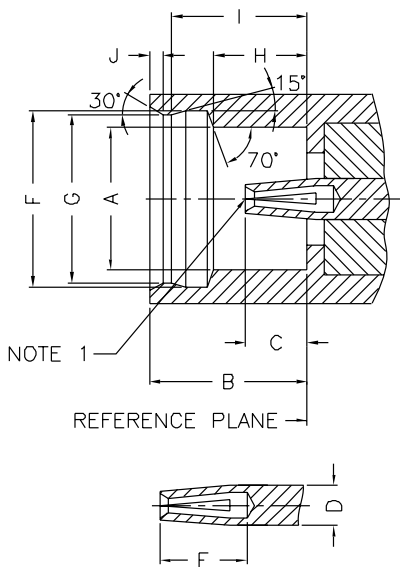

NOTE 1

JACK

Letter	Millimeters [Inches]	
	Minimum	Maximum
A	2.41 [.095]	–
B	2.60 [.102]	–
C	0.90 [.035]	1.20 [.047]
D	0.68 [.027]	0.72 [.028]
E	1.40 [.055]	–
F	3.00 [.118]	3.04 [.120]
G	2.87 [.113]	2.90 [.114]
H	1.57 [.062]	1.63 [.064]
I	2.30 [.091]	2.34 [.092]
J	–	0.23 [.009]

NOTE: 1. I.D. TO MEET VSWR AND CONTACT RESISTANCE WHEN MATED WITH 0.38/0.42 MM DIA. PIN.

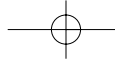

MMCX COAXIAL CONNECTORS

All connectors listed, unless otherwise noted, are gold-plated machined brass. Insulation is teflon with 30µ" gold-plated center contacts.

Dimensions are shown in millimeters and [inches].

C A B L E				G R O U P				L E G E N D			
01	58/ 58A/ 58C/ 141/ 303/ LMR195™/ B7806A	06A	179/ U DOUBLE BRAIDED	07	8/ 8A/ 213/ 393	09	B8227/ 89207	10	.141 SEMI-RIGID/ 402/U	11	.085 SEMI-RIGID/ 405/U
01A	55/ 142/ 223/ 400	07A	214	12	.250 SEMI-RIGID	13	.047 SEMI-RIGID/ B1674A	14	178/ 196	15	B8281/ B9231/ B9141
01B	LMR200™/ B7807A	07B	8X/ LMR240™/ B7808A	16	180/ 195/ 122/ B8218/ B1865A/ B1855	17	LMR600™	18	AT&T734A/ B1505A	19	AT&T735A/ B735A1
02	58 PLENUM/THINNET/ 122U/ B88240/ B89907	07C	B9913/ LMR400™/ B7810A/ B8214	08	6/ 143/ 212						
03	59/ 62/ 140/ 210	07D	B89913	08A	B1694A/ B9248						
03A	59/ U-20AWG	07E	11	08B	6 PLENUM/ B1695A						
04	59/ U PLENUM	07F	11/ U-14AWG/ B8213/ B9292/ B7731/ B1859A								
04A	59/ U PLENUM-20AWG										
05	174/ 188A/ 316/ B7805A										
05A	316/ U DOUBLE BRAIDED										
06	179/ 187/ B9221										

CRIMP ATTACHMENT FOR .085 AND .047 SEMI-RIGID CABLE

STRAIGHT CABLE PLUG

P.N.	Cable Group	Finish	Insulation	Impedance	Crimp Tool
262112	11	Gold	Teflon	50	N/A
262127	13	Gold	Teflon	50	N/A

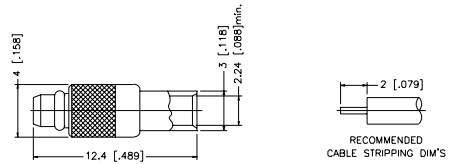
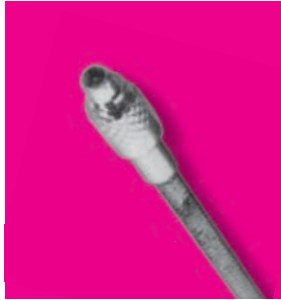

RIGHT ANGLE CABLE PLUG

P.N.	Cable Group	Finish	Insulation	Impedance	Crimp Tool
262113	11	Gold	Teflon	50	N/A
262128	13	Gold	Teflon	50	N/A

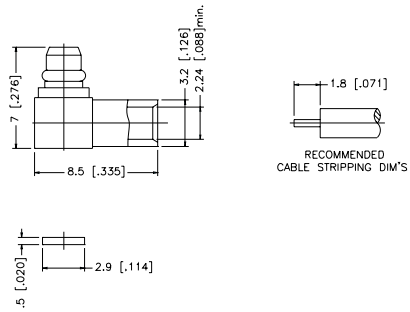

STRAIGHT CABLE JACK

P.N.	Cable Group	Finish	Insulation	Impedance	Crimp Tool
262123	11	Gold	Teflon	50	N/A
262125	13	Gold	Teflon	50	N/A

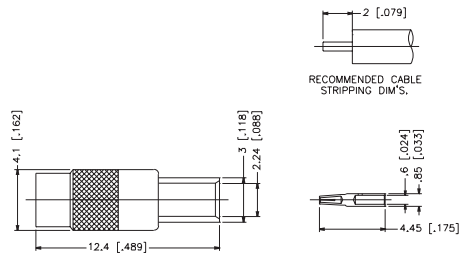

For Crimp Tool information, see page 183.

MMCX COAXIAL CONNECTORS

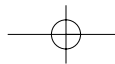

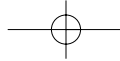

CRIMP ATTACHMENT FOR .085 AND .047 SEMI-RIGID CABLE

For Cable Group Legend, see page 9

STRAIGHT BULKHEAD JACK

P.N.	Cable Group	Finish	Insulation	Impedance	Crimp Tool
262124	11	Gold	Teflon	50	N/A
262126	13	Gold	Teflon	50	N/A

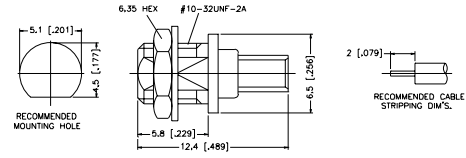
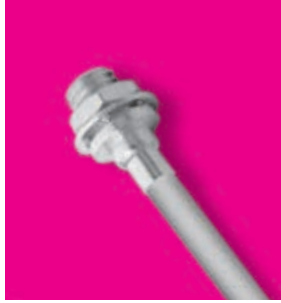

CRIMP ATTACHMENT FOR FLEXIBLE CABLE

STRAIGHT CABLE PLUG

P.N.	Cable Group	Finish	Insulation	Impedance	Crimp Tool
262101	5	Gold	Teflon	50	B
262110	5A	Gold	Teflon	50	C
262100	14	Gold	Teflon	50	B

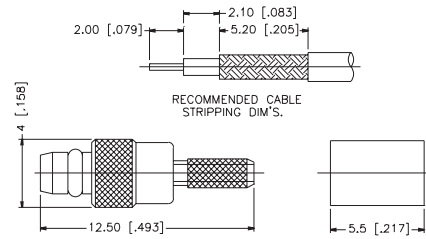
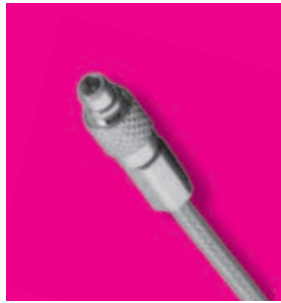

RIGHT ANGLE CABLE PLUG

P.N.	Cable Group	Finish	Insulation	Impedance	Crimp Tool
262103	5	Gold	Teflon	50	B
262111	5A	Gold	Teflon	50	C
262102	14	Gold	Teflon	50	B

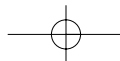
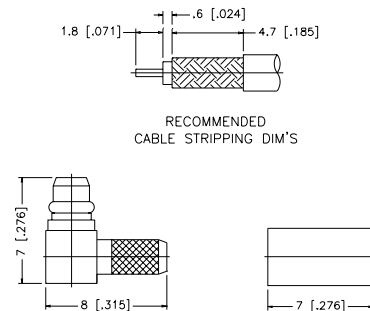
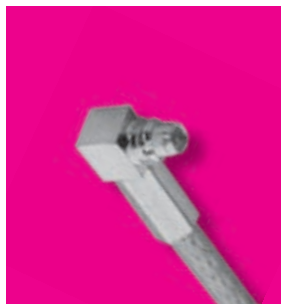



CRIMP ATTACHMENT FOR FLEXIBLE CABLE

For Cable Group Legend, see page 9

STRAIGHT CABLE JACK

P.N.	Cable Group	Finish	Insulation	Impedance	Crimp Tool
262118	5	Gold	Teflon	50	B
262119	5A	Gold	Teflon	50	C
262117	14	Gold	Teflon	50	B

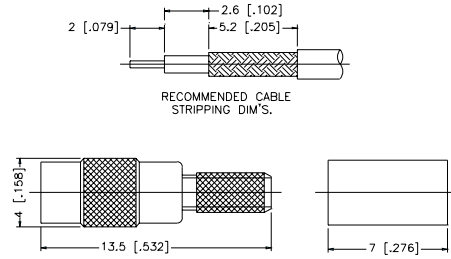
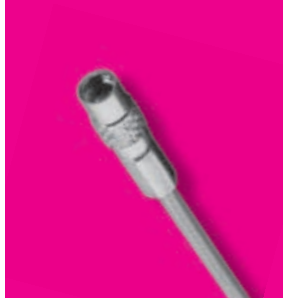

BULKHEAD CABLE JACK

P.N.	Cable Group	Finish	Insulation	Impedance	Crimp Tool
262121	5	Gold	Teflon	50	B
262122	5A	Gold	Teflon	50	C
262120	14	Gold	Teflon	50	B

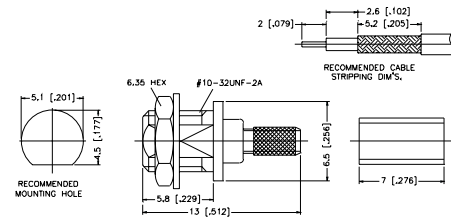
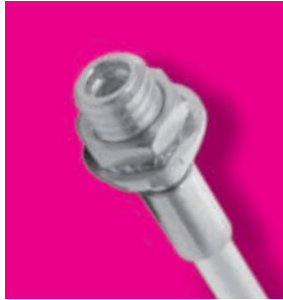

PRINTED CIRCUIT BOARD CONNECTORS

STRAIGHT PLUG FOR P.C. BOARD

P.N.	Cable Group	Finish	Insulation	Impedance	Crimp Tool
262114	N/A	Gold	Teflon	50	N/A
262108	N/A	Gold	Teflon	50	N/A

SURFACE MOUNT

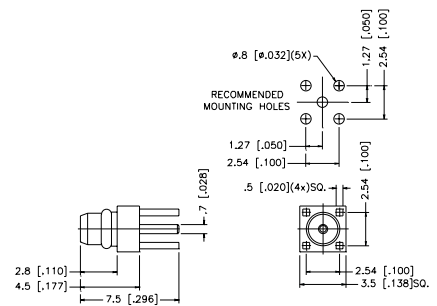

For Crimp Tool information, see page 183.

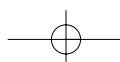

PRINTED CIRCUIT BOARD CONNECTORS

For Cable Group Legend, see page 9

STRAIGHT RECEPTACLE FOR P.C. BOARD

P.N.	Cable Group	Finish	Insulation	Impedance	Crimp Tool
262104	N/A	Gold	Teflon	50	N/A
262109	N/A	Gold SURFACE MOUNT	Teflon	50	N/A

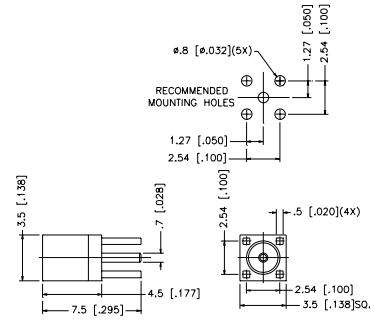

RIGHT ANGLE RECEPTACLE FOR P.C. BOARD

P.N.	Cable Group	Finish	Insulation	Impedance	Crimp Tool
262105	N/A	Gold	Teflon	50	N/A

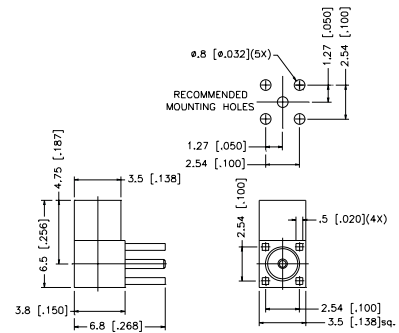

EDGE CARD VERTICAL MOUNT PLUG FOR P.C. BOARD

P.N.	Cable Group	Finish	Insulation	Impedance	Crimp Tool
262106	N/A	Gold	Teflon	50	N/A

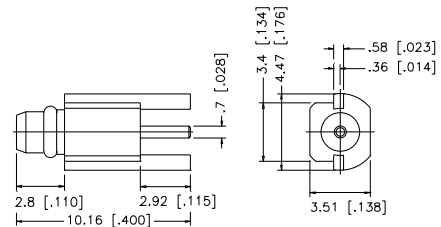



PRINTED CIRCUIT BOARD CONNECTORS

For Cable Group Legend, see page 9

EDGE CARD VERTICAL MOUNT JACK FOR P.C. BOARD

P.N.	Cable Group	Finish	Insulation	Impedance	Crimp Tool
262107	N/A	Gold	Teflon	50	N/A
262115	N/A	Gold	Teflon	50	N/A
OFFSET PC LEGS					



262107

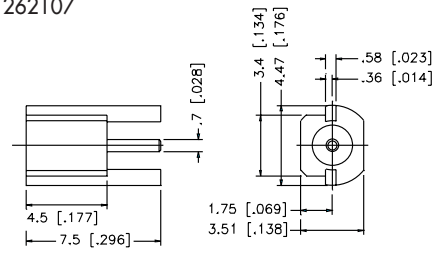

262115

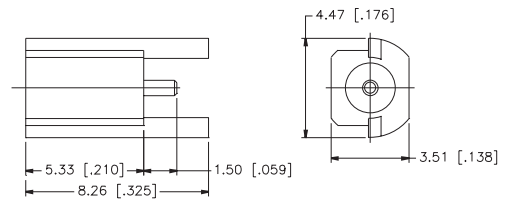

For Crimp Tool information, see page 183.

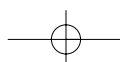

SURFACE MOUNT CONNECTORS

For Cable Group Legend, see page 9

SURFACE MOUNT JACK RECEPTACLE

P.N.	Cable Group	Finish	Insulation	Impedance	Crimp Tool
262116	N/A	Gold	LPC	50	N/A

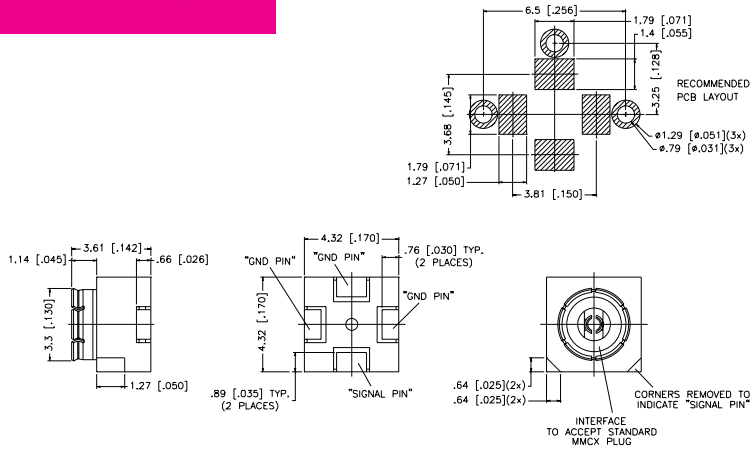

SURFACE MOUNT JACK RECEPTACLE — TAPE AND REEL

P.N.	Cable Group	Finish	Insulation	Impedance	Crimp Tool
262116TR	N/A	Gold	LPC	50	N/A
1500 per reel					

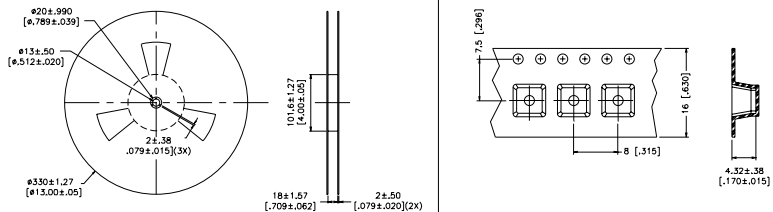

NOTE:
BLISTER TAPE PACKAGED UNIFORMLY FOR VERTICAL MOUNTING AND SUPPLIED IN ACCORDANCE WITH IEC 286-3/EA 481

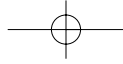

IN-SERIES ADAPTERS

For Cable Group Legend, see page 9

JACK-TO-JACK ADAPTER

P.N.	Cable Group	Finish	Insulation	Impedance	Crimp Tool
262129	N/A	Gold	Teflon	50	N/A

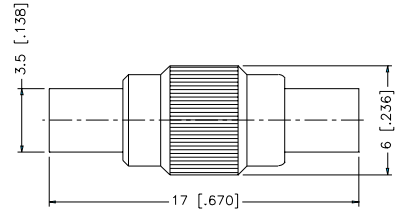

JACK-TO-JACK BULKHEAD ADAPTER

P.N.	Cable Group	Finish	Insulation	Impedance	Crimp Tool
262130	N/A	Gold	Teflon	50	N/A

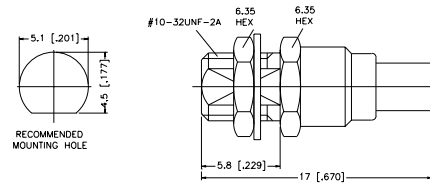

For Crimp Tool information, see page 183.

