

## MCX Connectors

### Product Facts

- Snap-on interface facilitates assembly
- Conforms to CECC interface specifications for MCX
- 30% smaller than SMB connectors
- Surface mount tape and reel for high volume
- 50 and 75 ohm versions available

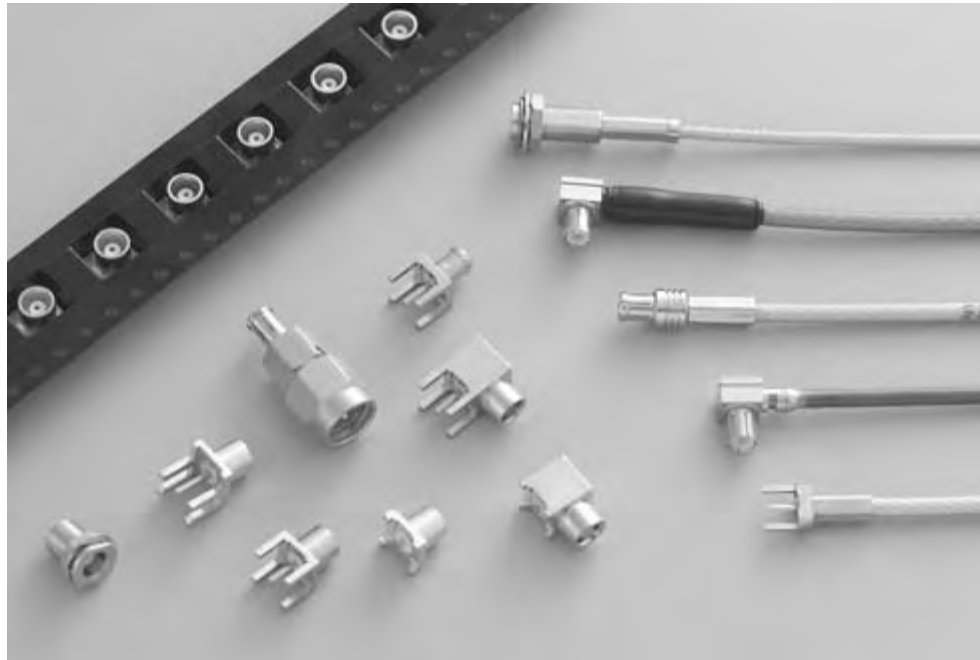

### Between Series Adapters

For MCX Between Series Adapters, see pages 251-260.

Tyco Electronics MCX microminiature snap-on connectors offer an excellent blend of size, durability and performance for emerging applications in GPS, automotive and wireless communications. MCX connectors are 30% smaller than traditional snap-on SMB connectors, offering greater packaging density and weight reduction. MCX connectors are mechanically robust with beryllium copper spring fingers rated at a minimum of 500 mating cycles. The snap-on interface facilitates assembly, eliminating the need for a threaded connection, and

ensuring full engagement. The forces to engage and disengage have been optimized to ensure ease of mating as well as to prevent damage to PCB solder connections. MCX connectors are designed for broad band performance, DC-6 GHz, and can be utilized for future system upgrades without concerns for performance degradation. Tyco Electronics MCX connectors are fully mateable with standard MCX connectors and conform to the CECC interface specifications.

MCX connectors are available in a broad range of

standard configurations for commercial applications. Tape and reel packaging for MCX surface mount straight and right-angle PCB receptacles is available to facilitate high volume pick and place manufacturing. MCX surface mount connectors are designed to withstand infrared reflow, convection and vapor phase soldering and provide a .254 [.010] standoff for optimal board cleaning. MCX plug and jack PCB receptacles also offer a direct board to board solution providing a nominal 7.11 [0.28] separation.

**MCX Connectors (Continued)**

**Specifications**

<b>General</b>		<b>CECC 22220 PARA</b>
Materials	—	Brass alloys UNS C36000 (ASTM-B16) or C38500 per QQ-B626, Beryllium copper per ASTM B-196, PTFE fluorocarbon per ASTM-D-1710
Finish	—	Center Contacts: Gold plated (ASTM-B488) over nickel plate (QQ-N-290)
	—	Outer Contacts: Gold plated (ASTM-B488) over nickel plate (OO-N-290)
	—	Housings: Nickel plated (QQ-N-290), tin (ASTM-B488) or Gold plated (ASTM-B488)
	—	All other metal parts shall be furnished so as to provide a connector which meets corrosion requirements of CECC 22220 PARA 4.6.10
Design	—	The design shall be such that the outline and interface dimensions shown in this catalog and the requirements of CECC 22220 PARA are met
<b>Electrical</b>		<b>CECC 22220 PARA (General requirements performance may vary by cable)</b>
Frequency	—	dc - 6 GHz
Nominal Impedance	—	50 ohms
Voltage Rating	—	335 Volts (VRMS Maximum) @ Sea Level
VSWR	4.4.1	1.25:1 Maximum @ 4 GHz
	—	1.35:1 Maximum @ 6 GHz
Insulation Resistance	4.4.4	10,000 Megohms Minimum
Insertion Loss	—	.1dB Maximum/1000 MHz
Dielectric Withstanding Voltage	4.4.5	1000 Volts (VRMS Minimum) @ Sea Level
<b>Contact Resistance</b>		
Center Contact	4.4.2	5.0 Milliohms Maximum
Outer Contact	4.4.3	1.0 Milliohms Maximum
Corona 70,000 ft.	—	250 Volts (VRMS Minimum) @ MHz
RF High Potential @ Sea Level	—	670 Volts (VRMS Minimum) @ MHz
Contact Current	—	1.5 ADC Max
<b>Mechanical</b>		<b>CECC 22220 PARA</b>
Force to Engage	4.5.4	15.5 N [3.4 lbs.] Maximum
Force to Disengage	—	8 – 20 N [1.8 – 4.5 lbs.]
Contact Captivation	4.5.2	Designed to maintain MCX interface when mating 10 N [2.2 lbs.] axial
Connector Durability	4.7.1	500 insertion and withdrawal cycles
<b>Environmental</b>		<b>CECC 22220 PARA</b>
Temperature Rating	—	-65°C + 165°C
Vibration	4.6.3	See CECC 22220
Moisture Resistance	4.6.4	See CECC 22220
Corrosion	4.6.10	See CECC 22220
Thermal Shock	4.6.7	See CECC 22220

Meets or exceeds requirements of CECC 22220. Tyco Electronics has design control and all data contained herein is subject to change without notice. Contact Tyco Electronics for specifications on other connector types.

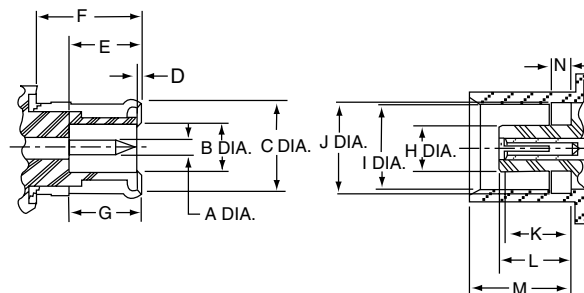

**Plug**

Letter	Minimum	Maximum
A	0.48 [.0189]	0.53 [.0208]
B	2.00 [.0788]	—
C	—	3.8 [.148]
D	0.00 [.000]	0.30 [.0118]
E	2.80 [.111]	3.20 [.125]
F	4.15 [.164]	—
G	2.80 [.111]	—

**Jack**

Letter	Minimum	Maximum
H	—	1.98 [.077]
I	3.42 [.135]	3.48 [.137]
J	3.60 [.142]	3.75 [.147]
K	2.30 [.091]	2.80 [.110]
L	2.60 [.103]	2.80 [.110]
M	4.00 [.158]	4.12 [.162]
N	0.75 [.0296]	0.85 [.0334]

**MCX Connectors (Continued)**

**Straight Cable Plug, Crimp**

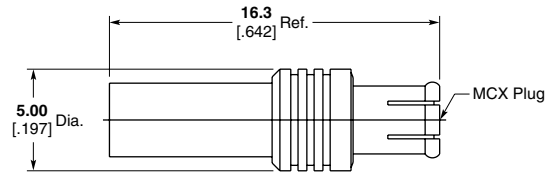

Cable	Plating	Part No.
RG 178/U, 196/U	Nickel	<b>1060869-1</b>
RG 174/U, 188/U, 316/U	Nickel	<b>1060872-1</b>
	Gold	<b>1060871-1</b>
RD-316	Nickel	<b>1060875-1</b>
	Gold	<b>1060875-2</b>

**Note:** For full crimp attachment consult Tyco Electronics at the numbers listed below.

**Right-Angle Cable Plug, Crimp**

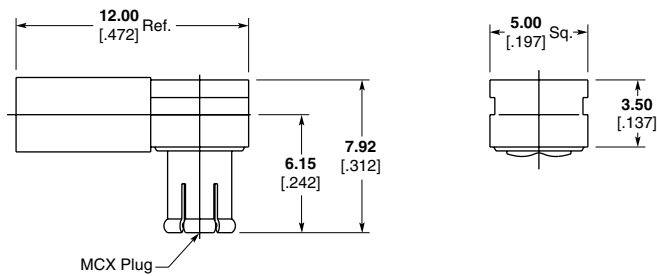

Cable	Plating	Part No.
RG 178/U, 196/U	Nickel	<b>1329293-1</b>
RG 188/U, 316/U RG 179/U, RG 187/U	Nickel	<b>1330723-1</b>
RD-316	Nickel	<b>1363301-1</b>
	Gold	<b>1363301-2</b>

**Straight Cable Terminal, PC Board, Without Center Contact**

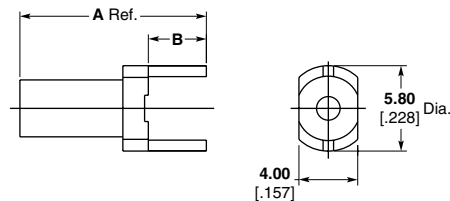
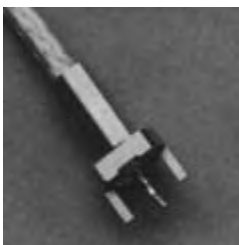

Cable	Dim. A	Dim. B	Plating	Part No.
RG 174/U, 188/U, 316/U	<b>11.76</b>	<b>3.94</b>	Nickel	<b>1060811-1</b>
	.463	.155	Gold	<b>1060811-2</b>
	<b>10.74</b>	<b>2.92</b>	Gold	<b>1060813-2</b>
	.423	.115		

**Note:** Part Numbers are RoHS compliant except: ♦ Indicates non-RoHS compliant.

**MCX Connectors (Continued)**

**Bulkhead Cable Jack**

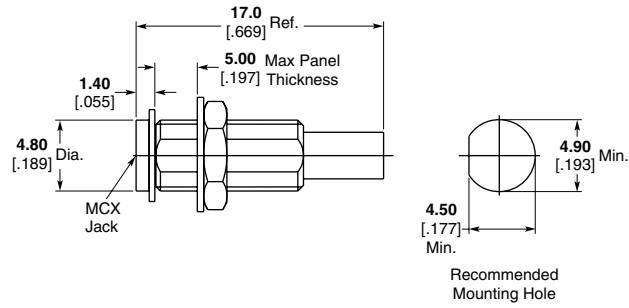

Cable	Plating	Part No.
RG 188/U, RG 316/U	Nickel	<b>1060883-1</b>

**Straight Cable Plug, Direct Solder Attachment For Semi-Rigid Cable**

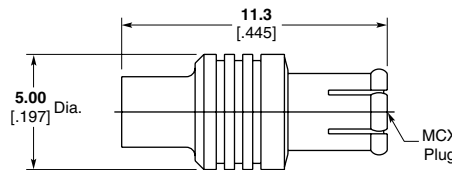

Cable	Plating	Part No.
RG 405/U [0.085]	Gold	<b>1060772-1</b>
.047	Gold	<b>1060772-2</b>

**Straight Cable Jack, Direct Solder Attachment For Semi-Rigid Cable**

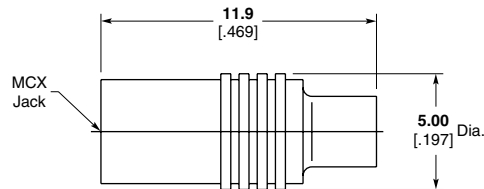

Cable	Plating	Part No.
RG 405/U [0.085]	Gold	<b>1060774-1</b>
.047	Gold	<b>1060774-2</b>

**Note:** Part Numbers are RoHS compliant except: ♦ Indicates non-RoHS compliant.

**MCX Connectors (Continued)**

**Right-Angle Plug Receptacle,  
Direct Solder Attachment  
For Semi-Rigid Cable**

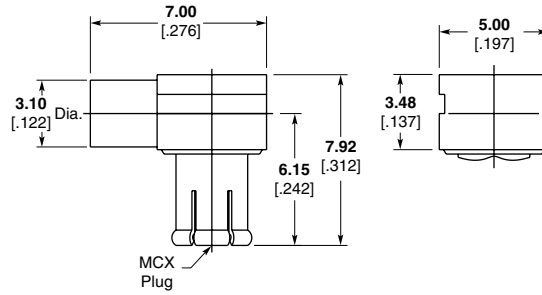

Cable	Plating	Part No.
RG 405/U	Gold	<b>1060787-1</b>

**Vertical Plug Receptacle,  
PC Board**

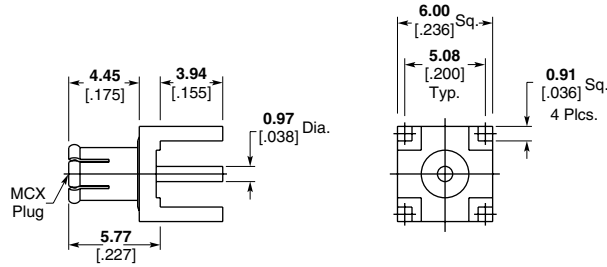

Plating	Part No.
Nickel	<b>1061015-1</b>
Gold	<b>1085221-1</b>

**Vertical Jack Receptacle,  
PC Board**

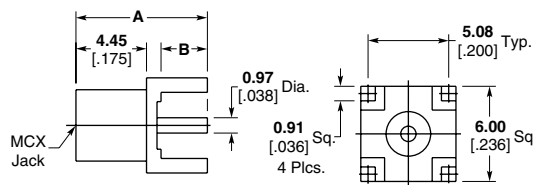
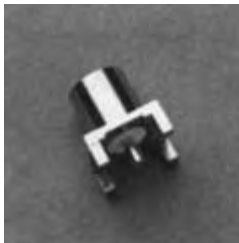

Dim. A	Dim. B	Plating	Part No.
<b>8.28</b>	<b>2.92</b>	Nickel	<b>1060985-1</b>
.326	.115	Gold	<b>1060984-1</b>
<b>9.30</b>	<b>3.94</b>	Nickel	<b>1060989-1</b>
.366	.155	Gold	<b>1330126-1</b>
<b>7.09</b>	<b>1.73</b>	Nickel	<b>1060996-1</b>
.279	.068	Gold	<b>1060995-1</b>

**Note:** Part Numbers are RoHS compliant except: ♦ Indicates non-RoHS compliant.

**MCX Connectors (Continued)**

**Vertical End Launch, PC Board**

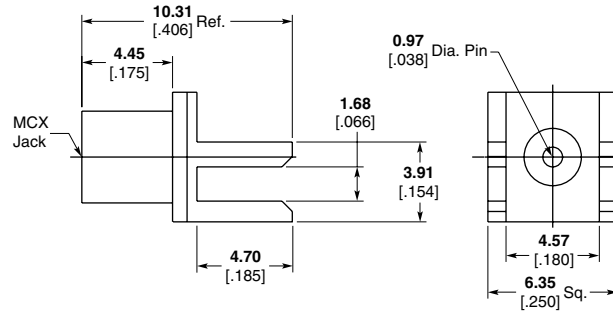

Plating	Part No.
Tin	<b>1061007-1</b>

**Right-Angle Jack Receptacle, PC Board**

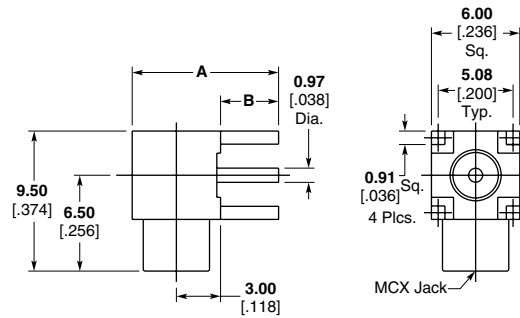
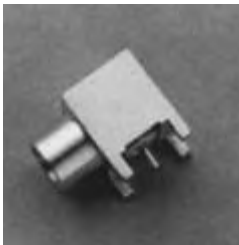

Dim. A	Dim. B	Plating	Part No.
<b>9.93</b> [.391]	<b>3.94</b> [.155]	Nickel	<b>1061023-1</b>
		Gold	<b>1061022-1</b>
<b>7.72</b> [.304]	<b>1.73</b> [.068]	Nickel	<b>1061027-1</b>
		Gold	<b>1061026-1</b>
<b>8.92</b> [.351]	<b>2.92</b> [.115]	Nickel	<b>1061030-1</b>
		Gold	<b>1061029-1</b>

**Jack Receptacle, Bulkhead Feedthrough**

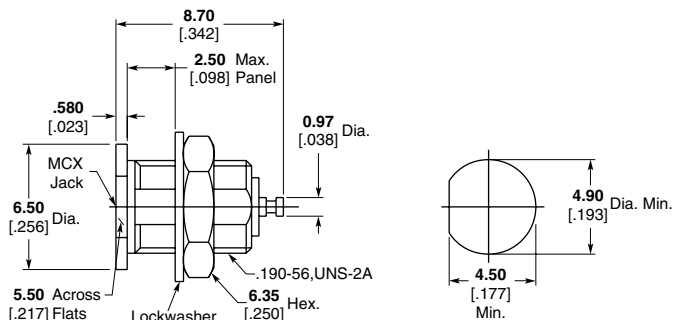

**Recommended Mounting Hole**

Plating	Part No.
Nickel	<b>1060960-1</b>
Gold	<b>1060959-1</b>

**Note:** Part Numbers are RoHS compliant except: ♦ Indicates non-RoHS compliant.

**MCX Connectors** (Continued)

**Vertical Jack Receptacle,  
Surface Mount**

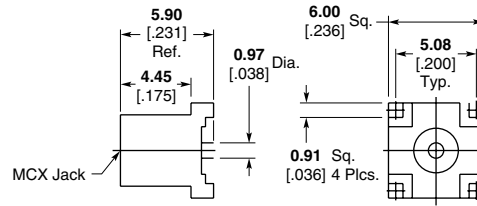

Plating	Part No.
Tin	6061002-1
	6061092-1 <sup>1</sup>

<sup>1</sup>Tape and Reel packaging. 900 connectors per reel (carrier width 16mm, carrier pitch 12mm).

**Right-Angle Jack Receptacle,  
Surface Mount**

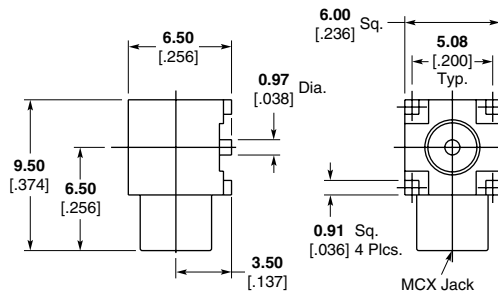

Plating	Part No.
Tin	6061035-1
Tin	6061094-1 <sup>1</sup>

<sup>1</sup>Tape and reel packaging. 750 connectors per reel (carrier width 24mm carrier pitch 12mm).

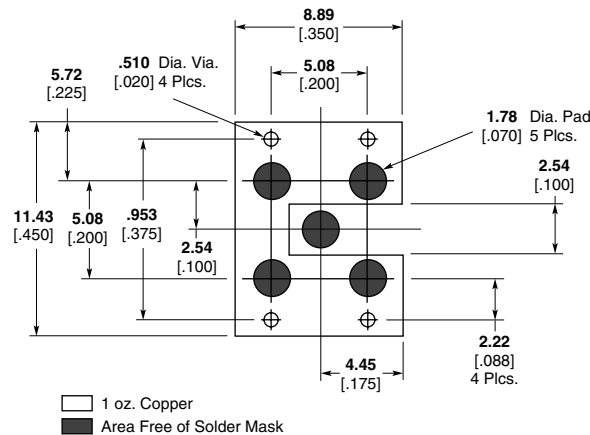

**Notes:**

1. Printed circuit board material: glass epoxy FR-4 or similar; relative permittivity: 4.8, 1 oz. copper clad both sides.
2. These dimensions valid for 1.58 [0.062] board thickness.
3. Decimal inch equivalents are shown in parentheses for general information only.

**Recommended Mounting Pattern for Microstrip Line**

**Note:** Part Numbers are RoHS compliant except: ♦ Indicates non-RoHS compliant.

**MCX Connectors** (Continued)

**Straight Cable Plug,  
Crimp, 75 Ohm**

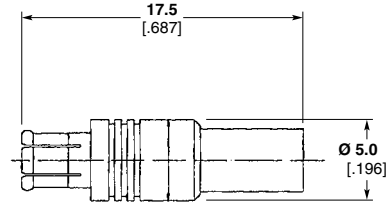

Cable	Plating	Part No.
RG 179/U	Nickel	1362990-1

**Right-Angle Cable Plug,  
Crimp, 75 Ohm**

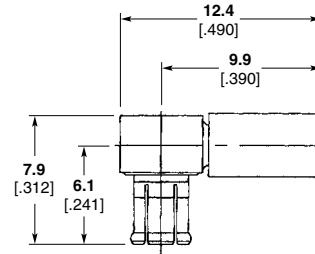

Cable	Plating	Part No.
RG 179/U	Nickel	1362991-1

**Vertical Plug, PC Board,  
75 Ohm**

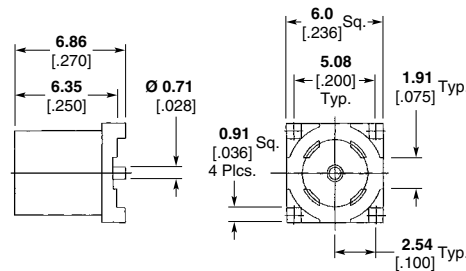

Plating	Part No.
Nickel	1361169-1

**Vertical Jack, PC Board,  
75 Ohm**

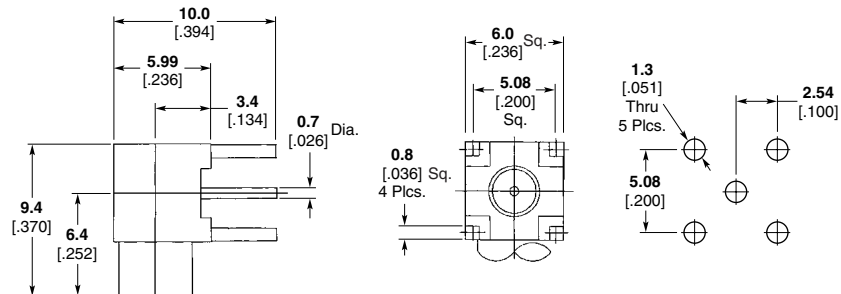

Plating	Part No.
Gold	1363106-1

**Note:** Part Numbers are RoHS compliant except: ♦ Indicates non-RoHS compliant.