

SMC Connectors

Product Facts

- Three-piece designs
- Fast, clean cable assembly
- Connector bodies preassembled
- Solderless termination — no danger of heat damage
- Center conductor and braid terminated with same tool
- Low noise level
- Miniature screw-on coupling
- TEFLON dielectric

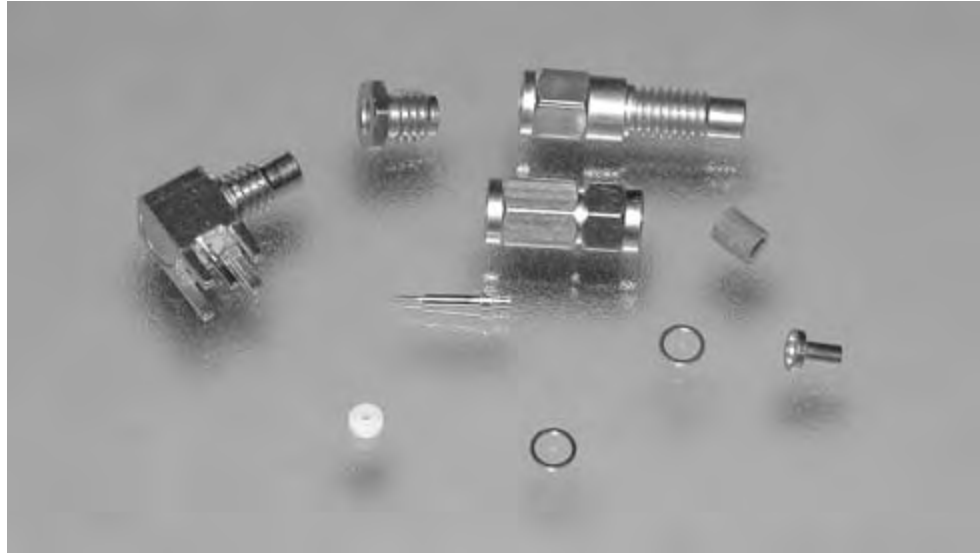

The SMC Connector is miniature and light-weight, especially designed for use in critical applications where limited space and vibration are of major concern.

This connector is designed in accordance with the requirements of Specification MIL-C-39012, Class II, Category B to assure the highest standards of electrical and mechanical performance. It has a constant impedance of 50 ohms, a voltage rating of 350 volts and provides excellent operation at frequencies up to 10 GHz. It also has a threaded coupling and can be used with a wide range of miniature coaxial cable sizes including RG 174, 197, 187, 188 and 316.

Materials

Brass — QQ-B-626
Beryllium Copper — QQ-C-530
Copper — QQ-C-576
TEFLON Insulation — MIL-P-19468

Plating

Gold — MIL-G-45204

Electrical Characteristics

Nominal Impedance — 50 ohms
Working Voltage — 335 volts rms
Frequency Range — 0 to 10 GHz
Insulation Resistance — 1000 megohms min.
Contact Resistance —
 Outer Contact — 1 milliohms
 Center Contact —
 Straight Connectors — 6 milliohms
 Right-Angle Connectors —
 12 milliohms
Dielectric Withstanding Voltage —
 1000 volts rms
RF Leakage — -60 dB min., between
 2 and 3 GHz
RF Insertion Loss —
 Straight Connectors — 0.25 dB max.
 at 4 GHz
 Right-Angle Connectors — 0.50 dB
 max. at 4 GHz
Corona Level — 250 volts min. at
 70,000 ft [21 336 m]

Mechanical Characteristics

Mating/Unmating — 10-32 threaded
 coupling
Cable Attachment — Crimp type,
 both center contact and braid
Coupling Nut Retention —
 35 lb [156 N] min.
Cable Retention — 20 lb [89 N] min.,
 GR-174 cable
Durability — 500 cycles per
 MIL-C-39012

Environmental Characteristics

Temperature Range —
 -65°C to +85°C
Vibration — MIL-STD-1344, Method
 2005, Condition IV
Salt Spray — MIL-STD-1344, Method
 1001, Condition B
Temperature Cycling —
 MIL-STD-1344, Method 1003,
 Condition A (except low temperature
 is -65°C)

TEFLON is a trademark of E.I. Dupont de Nemours and Company.

SMC Connectors (Continued)

Straight Plugs

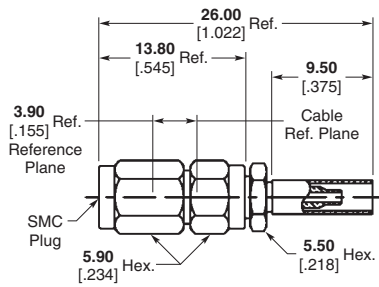

**Part No. 1060220-1
Crimp**

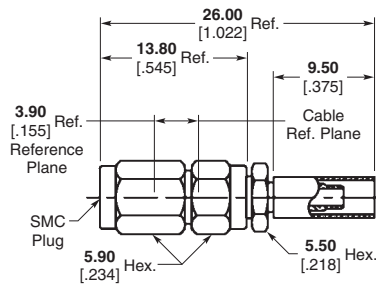

**Part No. 1060221-1
Crimp**

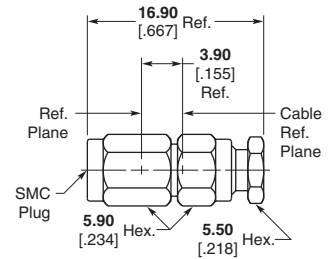

**Part No. 1060163-1
Clamp**

Cable Attachment	RG/U Cable	Part No.
Crimp	178, 178A, 178B 196, 196A	1060220-1
Crimp	174, 316 188, 188A	1060221-1
Clamp	174, 316 188, 188A	1060163-1

Straight Jacks

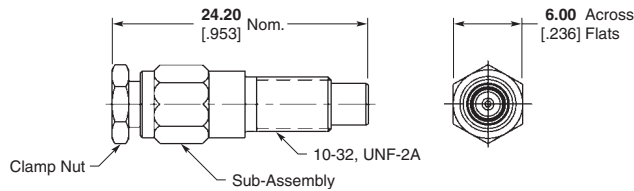

Cable Attachment	RG/U Cable	Part No.
Clamp	174, 316 188, 188A	1311638-1

Bulkhead Feedthrough Cable Jacks

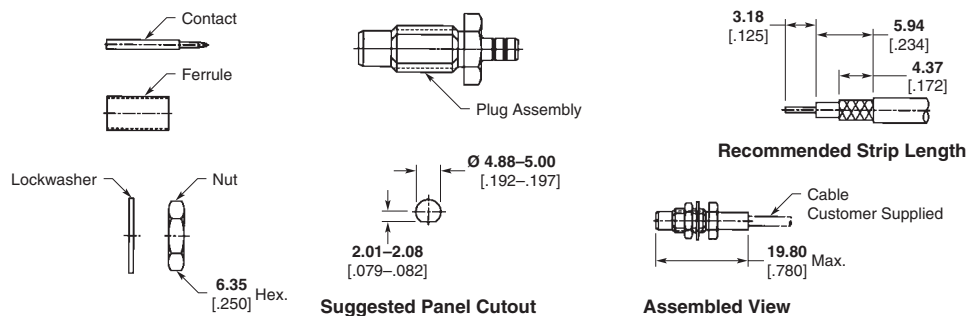

Cable Attachment	RG/U Cable	Part No.
Crimp	174, 316 188, 188A	51751-1

Note: Part Numbers are RoHS compliant except: ♦ Indicates non-RoHS compliant.

SMC Connectors (Continued)

Press-In Panel Jacks, Straight Terminal

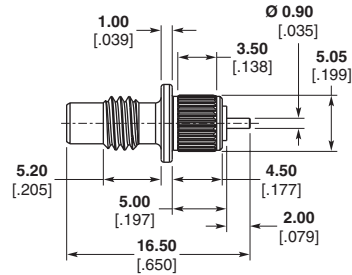

Part No. 1460470-1

Right-Angle Cable Plug

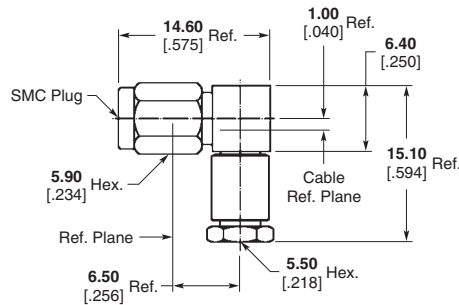

Cable Attachment	RG/U Cable	Part No.
Clamp	174, 316 188, 188A	1060183-1

PC Board Jack Receptacles

Straight

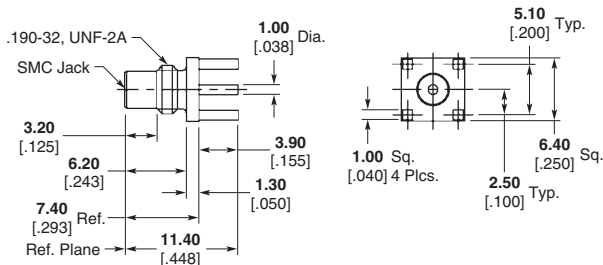

Part No. 1060256-1

Right-Angle

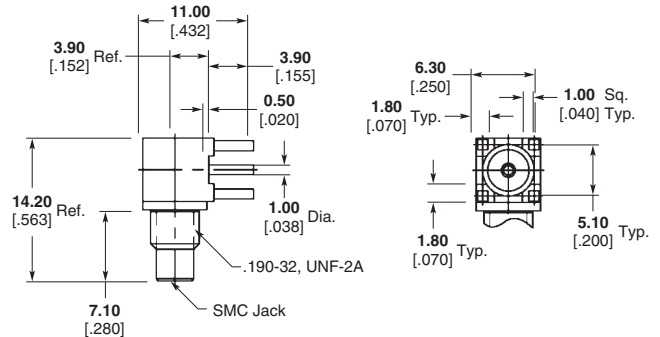

Part No. 1060259-1

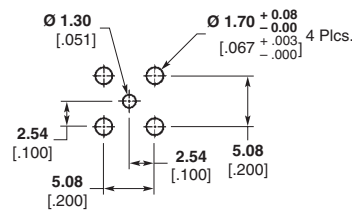

Recommended PC Board Layout

Note: Part Numbers are RoHS compliant except: ♦ Indicates non-RoHS compliant.