



## BNC COAXIAL CONNECTORS

The Connex BNC connectors are made to a high quality level. Medium size coaxial connectors with bayonet lock. 50 ohm impedance for applications up to 4 GHz and 75 ohm impedance up to 2 GHz.

### 75 OHM SERIES

Within the internationally standardized BNC mating face dimensions, a perfect 75 ohm characteristic impedance cannot be realized. However, at frequencies up to 1000 MHz, the small impedance deviation is negligible for practical applications. Connex true 75 ohm connectors with a typical VSWR reading of 1.06:1 at 2000 MHz are identified by an asterisk following the part number.

All 75 ohm BNC connectors and 50 ohm BNC connectors are intermateable without restrictions.

*Note: Silverplated bodies are available by adding "S" to end of part number. Nexcote (white bronze) plating with no nickel under body or center contact is available by adding "NEX" to end of part number.*

## ELECTRICAL SPECIFICATIONS

|                                 |   |   |
|---------------------------------|---|---|
| Impedance                       | 50 ohm  | 75 ohm  |
| Frequency Range                 | 0–4 GHz   | 0–1 GHz   |
| Working Voltage                 | 500 Volts rms.  | 500 Volts rms.  |
| Dielectric Withstanding Voltage | 1500 Volts rms.   | 1500 Volts rms.   |
| VSWR                            | 1.3 max. 0–4 GHz  | 1.05+0.1f(GHz) DC to 1 GHz                                |
| Contact Resistance              | Center contact 1.5 milliohm<br>Outer contact 1.0 milliohm | Center contact 1.5 milliohm<br>Outer contact 1.0 milliohm |
| Insulation Resistance           | 5000 megohms (min)  | 5000 megohms (min)  |

## MATERIAL SPECIFICATIONS

| PARTS NAME     |        | MATERIAL                                      | FINISH                |
|----------------|--------|---|-----------------------|
| Center Contact | Male   | Brass   | Gold or Silver plated |
|                | Female | Phosphor Bronze (nominal) or Beryllium Copper | Gold or Silver plated |
| Metal parts    |        | Brass   | Nickel*               |
| Insulators     |        | Teflon, Delrin, PBT polyester                 | None                  |
| Clamp gaskets  |        | Silicone rubber, Synthetic rubber             | None                  |
| Crimp ferrule  |        | Annealed copper                               | Nickel*               |



## BNC COAXIAL CONNECTORS

### INTERFACE MATING DIMENSIONS

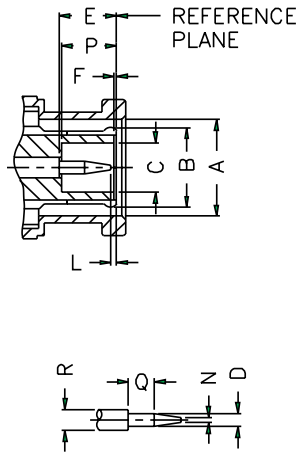

### PLUG

| Letter | Millimeters [Inches]                   |             |
|--------|--|-------------|
|        | Minimum                                | Maximum     |
| A      | 9.78 [.385]                            | 9.91 [.390] |
| B      | FLARED TO MEET GOOD ELECTRICAL CONTACT |             |
| C      | 4.83 [.190]                            | –           |
| D      | 1.32 [.052]                            | 1.37 [.054] |
| E      | 5.33 [.210]                            | 5.84 [.230] |
| F      | 0.15 [.006]                            | 0.46 [.018] |
| L      | 0.08 [.003]                            | 1.02 [.040] |
| N      | –                                      | 0.64 [.025] |
| P      | 5.28 [.208]                            | 5.79 [.228] |
| Q      | 1.98 [.078]                            | –           |
| R      | 2.06 [.081]                            | 2.21 [.087] |

### JACK

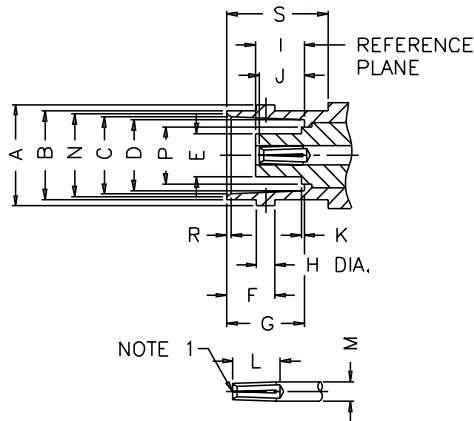

| Letter | Millimeters [Inches] |              |
|--------|----------------------|--------------|
|        | Minimum              | Maximum      |
| A      | 10.97 [.432]         | 11.07 [.436] |
| B      | 9.60 [.378]          | 9.70 [.382]  |
| C      | 8.31 [.327]          | 8.46 [.333]  |
| D      | 8.10 [.319]          | 8.15 [.321]  |
| E      | –                    | 4.72 [.186]  |
| F      | 5.18 [.204]          | 5.28 [.208]  |
| G      | 8.31 [.327]          | 8.51 [.335]  |
| H      | 1.91 [.075]          | 2.06 [.081]  |
| I      | 4.78 [.188]          | 5.28 [.208]  |
| J      | 4.72 [.186]          | 5.23 [.206]  |
| K      | –                    | 0.15 [.006]  |
| L      | 4.95 [.195]          | –            |
| M      | 2.06 [.081]          | 2.21 [.087]  |
| N      | 8.79 [.346]          | 9.04 [.356]  |
| P      | –                    | 6.50 [.256]  |
| R      | 0.38 [.015]          | 0.76 [.030]  |
| S      | 10.52 [.414]         | –            |

NOTE 1: I.D. TO MEET VSWR AND CONTACT RESISTANCE WHEN MATED WITH 1.32/1.37 MM DIA. PIN.

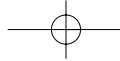

## BNC COAXIAL CONNECTORS

All connector bodies, unless otherwise noted, are nickel plated. Center contacts are 3µ" gold plated. Insulators are Delrin, unless otherwise noted.

Silver plating and Teflon insulators are available on virtually all BNC connectors. Please contact Connex for samples and quotes.

All dimensions in millimeters and [inches].

| C A B L E G R O U P L E G E N D |   |     |  |
|---------------------------------|---|-----|--|
| 01                              | 58/ 58A/ 58C/ 141/ 303/ LMR195™/ B7806A | 06A | 179/ U DOUBLE BRAIDED                    |
| 01A                             | 55/ 142/ 223/ 400                       | 07  | 8/ 8A/ 213/ 393                          |
| 01B                             | LMR200™/ B7807A                         | 07A | 214                                      |
| 02                              | 58 PLENUM/THINNET/ 122U/ B88240/ B89907 | 07B | 8X/ LMR240™/ B7808A                      |
| 03                              | 59/ 62/ 140/ 210                        | 07C | B9913/ LMR400™/ B7810A/ B8214            |
| 03A                             | 59/ U-20AWG                             | 07D | B89913                                   |
| 04                              | 59/ U PLENUM                            | 07E | 11                                       |
| 04A                             | 59/ U PLENUM-20AWG                      | 07F | 11/ U-14AWG/ B8213/ B9292/ B7731/ B1859A |
| 05                              | 174/ 188A/ 316/ B7805A                  | 08  | 6/ 143/ 212                              |
| 05A                             | 316/ U DOUBLE BRAIDED                   | 08A | B1694A/ B9248                            |
| 06                              | 179/ 187/ B9221                         | 08B | 6 PLENUM/ B1695A                         |
|                                 |   | 09  | B8227/ 89207                             |
|                                 |   | 10  | .141 SEMI-RIGID/ 402/U                   |
|                                 |   | 11  | .085 SEMI-RIGID/ 405/U                   |
|                                 |   | 12  | .250 SEMI-RIGID                          |
|                                 |   | 13  | .047 SEMI-RIGID/ B1674A                  |
|                                 |   | 14  | 178/ 196                                 |
|                                 |   | 15  | B8281/ B9231/ B9141                      |
|                                 |   | 15A | B88281                                   |
|                                 |   | 16  | 180/ 195/ 122/ B8218/ B1865A/ B1855      |
|                                 |   | 17  | LMR600™                                  |
|                                 |   | 18  | AT&T734A/ B1505A                         |
|                                 |   | 19  | AT&T735A/ B735A1                         |

## PLUG CRIMP ATTACHMENTS FOR FLEXIBLE CABLE

### STRAIGHT CRIMP PLUG — SINGLE CRIMP

| P.N.          | Cable Group | Finish | Insulation | Impedance | Crimp Tool |
|---------------|-------------|--------|------------|-----------|------------|
| Diecast shell |             |        |            |           |            |
| 112108        | 01          | Nickel | Delrin     | 50        | E          |
| 112110        | 03          | Nickel | Delrin     | 50        | E          |
| 112112        | 02          | Nickel | Delrin     | 50        | E          |
| 112114        | 04          | Nickel | Delrin     | 50        | E          |

Remark: Only for Solid Center Conductor Cable

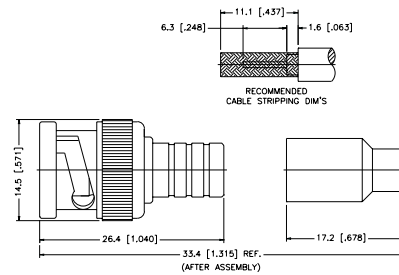

### STRAIGHT CRIMP PLUG — CAPTIVE CONTACT — STANDARD CABLE

| P.N.                             | Cable Group | Finish | Insulation | Impedance | Crimp Tool |
|----------------------------------|-------------|--------|------------|-----------|------------|
| Brass Shell                      |             |        |            |           |            |
| 112116                           | 01          | Nickel | Delrin     | 50        | A          |
| 112514                           | 01A         | Nickel | Delrin     | 50        | A          |
| 112597                           | 01B         | Nickel | Teflon     | 50        | A          |
| 112118                           | 03          | Nickel | Delrin     | 50        | A          |
| 112119                           | 03          | Nickel | Delrin     | 75        | A          |
| 112952*                          | 03          | Nickel | Teflon     | 75        | A          |
| 112507                           | 03A         | Nickel | Delrin     | 75        | A          |
| 112956*                          | 03A         | Nickel | Teflon     | 75        | A          |
| 112650                           | —           | Nickel | Teflon     | 75        | A          |
| COMMSCOPE F59 HEC-2/B1186A CABLE |             |        |            |           |            |
| 112562                           | 07          | Nickel | Teflon     | 50        | D          |
| 112589                           | 07A         | Nickel | Teflon     | 50        | D          |
| 112533                           | 07B         | Nickel | Delrin     | 50        | A          |
| 112563                           | 07C         | Nickel | Teflon     | 50        | L          |
| 112627                           | 07D         | Nickel | Teflon     | 50        | L          |
| 112576                           | 07E         | Nickel | Teflon     | 75        | D          |
| 112669                           | 07E         | Nickel | Teflon     | 50        | D          |
| 112606                           | 07F         | Nickel | Teflon     | 75        | D          |
| 112508                           | 08          | Nickel | Delrin     | 75        | E          |
| 112565                           | 08A         | Nickel | Delrin     | 75        | E          |
| 112957*                          | 08A         | Nickel | Teflon     | 75        | H          |
| 112519                           | 08B         | Nickel | Delrin     | 75        | E          |
| 112958*                          | 08B         | Nickel | Teflon     | 75        | E          |
| 112509                           | 15          | Nickel | Delrin     | 75        | E          |
| 112953*                          | 15          | Nickel | Teflon     | 75        | E          |
| 112625                           | 15A         | Nickel | Delrin     | 75        | E          |
| 112951*                          | 18          | Nickel | Teflon     | 75        | A          |
| 112950*                          | 19          | Nickel | Teflon     | 75        | B          |
| 112700                           | LMR300™     | Nickel | Teflon     | 50        | D/E        |

|               |    |        |        |    |   |
|---------------|----|--------|--------|----|---|
| Diecast Shell |    |        |        |    |   |
| 112120        | 01 | Nickel | Delrin | 50 | A |
| 112122        | 03 | Nickel | Delrin | 50 | A |
| 112123        | 03 | Nickel | Delrin | 75 | A |

\*Center contact .053" diameter, 30µ" Au. True 75 ohm. Use .044 hex or 12-indent crimp

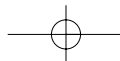
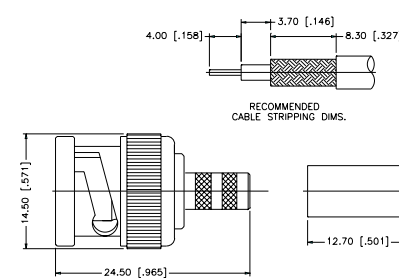
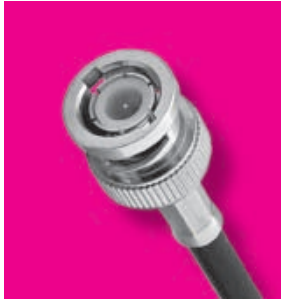

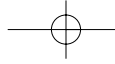

## PLUG CRIMP ATTACHMENTS FOR FLEXIBLE CABLE

For Cable Group Legend, see page 69

### STRAIGHT CRIMP PLUG — CAPTIVE CONTACT — PLENUM CABLE

| P.N.                 | Cable Group | Finish | Insulation | Impedance | Crimp Tool |
|----------------------|-------------|--------|------------|-----------|------------|
| <b>Brass Shell</b>   |             |        |            |           |            |
| 112124               | 02          | Nickel | Delrin     | 50        | A          |
| 112127               | 04          | Nickel | Delrin     | 75        | A          |
| 112544               | 04A         | Nickel | Delrin     | 75        | A          |
| <b>Diecast Shell</b> |             |        |            |           |            |
| 112128               | 02          | Nickel | Delrin     | 50        | A          |

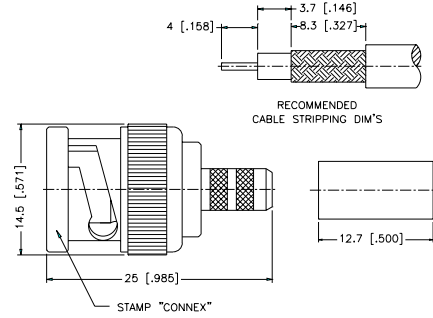

### STRAIGHT CRIMP PLUG — CAPTIVE CONTACT — MINIATURE CABLE

| P.N.                 | Cable Group | Finish | Insulation | Impedance | Crimp Tool |
|----------------------|-------------|--------|------------|-----------|------------|
| <b>Brass Shell</b>   |             |        |            |           |            |
| 112132               | 05          | Nickel | Delrin     | 50        | B          |
| 112512               | 05A         | Nickel | Delrin     | 50        | B          |
| 112133               | 06          | Nickel | Delrin     | 75        | B          |
| 112644               | 06A         | Nickel | Delrin     | 75        | B          |
| 112516               | 14          | Nickel | Delrin     | 50        | B          |
| 112521               | 16          | Nickel | Delrin     | 75        | B          |
| 112955*              | 16          | Nickel | Teflon     | 75        | B          |
| 112975*              | 04A         | Nickel | Teflon     | 75        | B          |
| <b>Diecast Shell</b> |             |        |            |           |            |
| 112134               | 05          | Nickel | Delrin     | 50        | B          |
| 112135               | 06          | Nickel | Delrin     | 75        | B          |

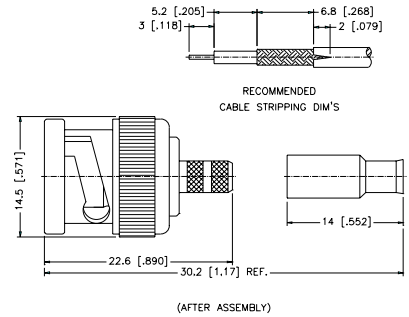

Remark: With teflon sleeve/Hex crimp size.178"  
 \*Center contact .053" diameter, 30µ Au.  
 True 75 ohm. Use .044 hex or 12-indent crimp

### STRAIGHT SOLDER PLUG — SEMI-RIGID CABLE

| P.N.   | Cable Group | Finish      | Insulation | Impedance | Crimp Tool |
|--------|-------------|-------------|------------|-----------|------------|
| 112551 | 10          | Nickel/Gold | Teflon     | 50        | N/A        |
| 112520 | 10          | Nickel/Gold | Teflon     | 75        | N/A        |
| 112552 | 11          | Nickel/Gold | Teflon     | 50        | N/A        |

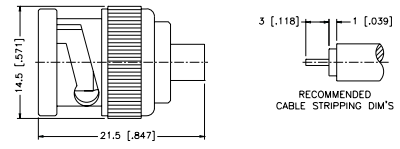
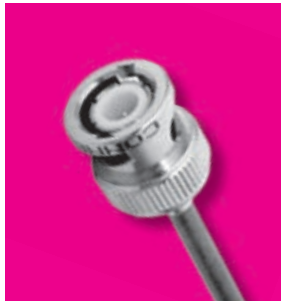

112551

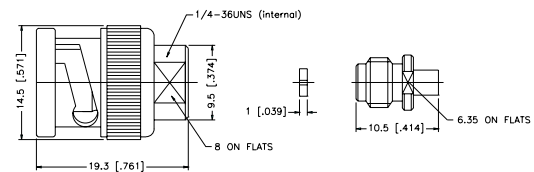
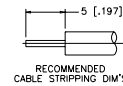

112552

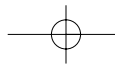

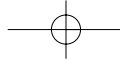

## PLUG CRIMP ATTACHMENTS FOR FLEXIBLE CABLE

For Cable Group Legend, see page 69

### STRAIGHT CRIMP PLUG — PIN-IN-PIN — MINIATURE CABLE

| P.N.                 | Cable Group | Finish | Insulation | Impedance | Crimp Tool |
|----------------------|-------------|--------|------------|-----------|------------|
| <b>Brass Shell</b>   |             |        |            |           |            |
| 112136               | 05          | Nickel | Delrin     | 50        | B          |
| 112137               | 06          | Nickel | Delrin     | 75        | B          |
| <b>Diecast Shell</b> |             |        |            |           |            |
| 112138               | 05          | Nickel | Delrin     | 50        | B          |
| 112139               | 06          | Nickel | Delrin     | 75        | B          |

Remark: Hex. crimp size .128"

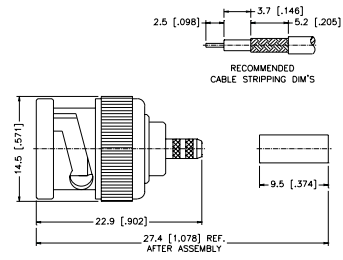
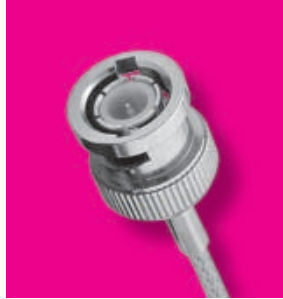

4-Way Indent Crimp  
Tool No. 47001



Ferrule Crimp Tool Crimped Size .128"  
Tool No. 47-10150

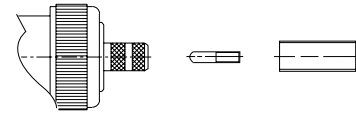

### STRAIGHT CRIMP PLUG — MINIATURE CABLE

| P.N.                 | Cable Group | Finish | Insulation | Impedance | Crimp Tool |
|----------------------|-------------|--------|------------|-----------|------------|
| <b>Brass Shell</b>   |             |        |            |           |            |
| 112140               | 06          | Nickel | TPX        | 75        | B          |
| <b>Diecast Shell</b> |             |        |            |           |            |
| 112142               | 06          | Nickel | TPX        | 75        | B          |

Remark: TPX Insulator/75 ohm AVAILABLE ONLY

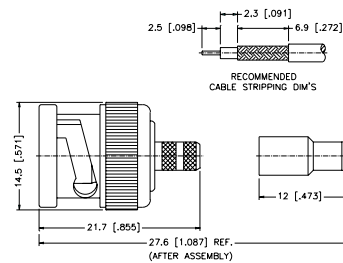
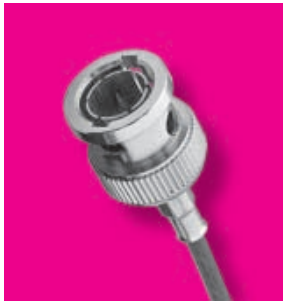

For Reverse Polarized connectors, add RP to standard part number. Contact Connex marketing for availability.  
For Crimp Tool information, see page 183.

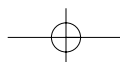

## RIGHT ANGLE PLUG CRIMP ATTACHMENTS FOR FLEXIBLE CABLE

For Cable Group Legend, see page 69

### RIGHT ANGLE CRIMP/SOLDER PLUG — STANDARD CABLE

| P.N.               | Cable Group | Finish | Insulation | Impedance | Crimp Tool |
|--------------------|-------------|--------|------------|-----------|------------|
| <b>Brass Shell</b> |             |        |            |           |            |
| 112162             | 01          | Nickel | Delrin     | 50        | A          |
| 112526             | 01A         | Nickel | Delrin     | 50        | A          |
| 112599             | 01B         | Nickel | Teflon     | 50        | A          |
| 112164             | 03          | Nickel | Delrin     | 50        | A          |
| 112165             | 03          | Nickel | Delrin     | 75        | A          |
| 112960*            | 03          | Nickel | Teflon     | 75        | A          |
| 112467             | 01          | Nickel | Teflon     | 50        | A          |
| 112470             | 03          | Nickel | Teflon     | 75        | A          |
| 112594             | 07          | Nickel | Teflon     | 50        | D          |
| 112595             | 07A         | Nickel | Teflon     | 50        | D          |
| 112601             | 07B         | Nickel | Delrin     | 50        | A          |
| 112596             | 07C         | Nickel | Delrin     | 50        | D          |
| 112961*            | 18          | Nickel | Teflon     | 75        | A          |
| 112962*            | 19          | Nickel | Teflon     | 75        | B          |

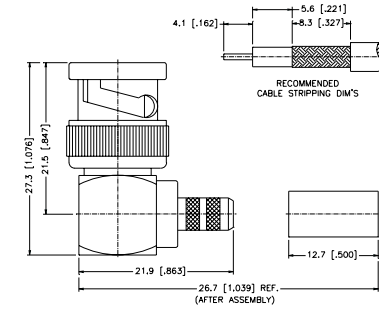

| P.N.                 | Cable Group | Finish | Insulation | Impedance | Crimp Tool |
|----------------------|-------------|--------|------------|-----------|------------|
| <b>Diecast Shell</b> |             |        |            |           |            |
| 112166               | 01          | Nickel | Delrin     | 50        | A          |
| 112168               | 03          | Nickel | Delrin     | 50        | A          |
| 112169               | 03          | Nickel | Delrin     | 75        | A          |

Remark: Cable Center Conductor Solder to pin directly

\*Center contact .053" diameter, 30μ" Au.  
True 75 ohm. Use .044 hex or 12-indent crimp

### RIGHT ANGLE CRIMP/SOLDER PLUG — PLENUM CABLE

| P.N.                 | Cable Group | Finish | Insulation | Impedance | Crimp Tool |
|----------------------|-------------|--------|------------|-----------|------------|
| <b>Brass Shell</b>   |             |        |            |           |            |
| 112170               | 02          | Nickel | Delrin     | 50        | A          |
| 112173               | 04          | Nickel | Delrin     | 75        | A          |
| <b>Diecast Shell</b> |             |        |            |           |            |
| 112174               | 02          | Nickel | Delrin     | 50        | A          |
| 112177               | 04          | Nickel | Delrin     | 75        | A          |

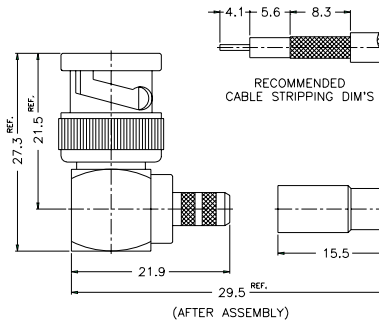

Remark: Cable Center Conductor Solder to pin directly

### RIGHT ANGLE CRIMP/SOLDER PLUG — MINIATURE CABLE

| P.N.               | Cable Group | Finish | Insulation | Impedance | Crimp Tool |
|--------------------|-------------|--------|------------|-----------|------------|
| <b>Brass Shell</b> |             |        |            |           |            |
| 112178             | 05          | Nickel | Delrin     | 50        | B          |
| 112528             | 05A         | Nickel | Delrin     | 50        | B          |
| 112179             | 06          | Nickel | Delrin     | 75        | B          |
| 112646             | 06A         | Nickel | Delrin     | 75        | B          |
| 112588             | 16          | Nickel | Delrin     | 75        | B          |

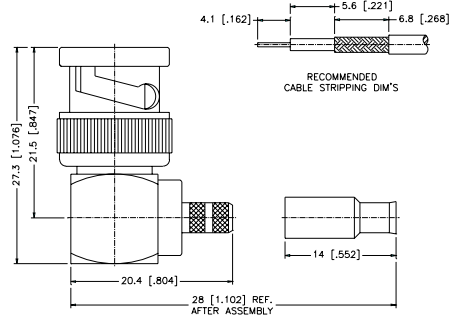

Remark: Cable Center Conductor Solder to pin directly

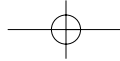

## RIGHT ANGLE PLUG CRIMP ATTACHMENTS FOR FLEXIBLE CABLE

For Cable Group Legend, see page 69

### RIGHT ANGLE SOLDER PLUG — SEMI-RIGID CABLE

| P.N.   | Cable Group | Finish      | Insulation | Impedance | Crimp Tool |
|--------|-------------|-------------|------------|-----------|------------|
| 112617 | 10          | Nickel/Gold | Teflon     | 50        | N/A        |
| 112614 | 11          | Nickel/Gold | Teflon     | 50        | N/A        |

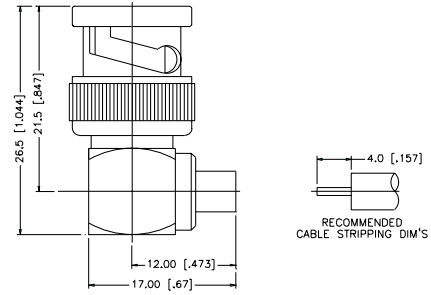

### RIGHT ANGLE CRIMP/CRIMP PLUG — STANDARD CABLE

| P.N.                 | Cable Group | Finish | Insulation | Impedance | Crimp Tool |
|----------------------|-------------|--------|------------|-----------|------------|
| <b>Brass Shell</b>   |             |        |            |           |            |
| 112182               | 01          | Nickel | Delrin     | 50        | A          |
| 112184               | 03          | Nickel | Delrin     | 50        | A          |
| 112185               | 03          | Nickel | Delrin     | 75        | A          |
| 112540               | 08          | Nickel | Teflon     | 75        | E          |
| 112539               | 15          | Nickel | Teflon     | 75        | A          |
| <b>Diecast Shell</b> |             |        |            |           |            |
| 112186               | 01          | Nickel | Delrin     | 50        | A          |
| 112189               | 03          | Nickel | Delrin     | 75        | A          |

Remark: Crimp/Crimp Type

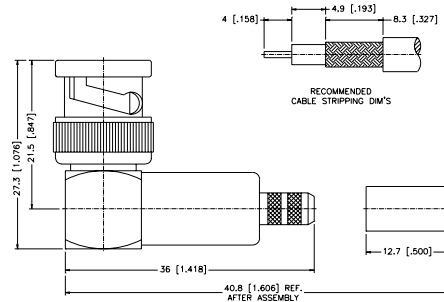

### RIGHT ANGLE CRIMP/CRIMP PLUG — PLENUM CABLE

| P.N.                 | Cable Group | Finish | Insulation | Impedance | Crimp Tool |
|----------------------|-------------|--------|------------|-----------|------------|
| <b>Brass Shell</b>   |             |        |            |           |            |
| 112190               | 02          | Nickel | Delrin     | 50        | A          |
| 112193               | 04          | Nickel | Delrin     | 75        | A          |
| <b>Diecast Shell</b> |             |        |            |           |            |
| 112194               | 02          | Nickel | Delrin     | 50        | A          |
| 112197               | 04          | Nickel | Delrin     | 75        | A          |

Remark: Crimp/Crimp Type

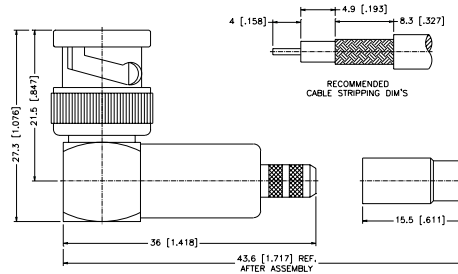
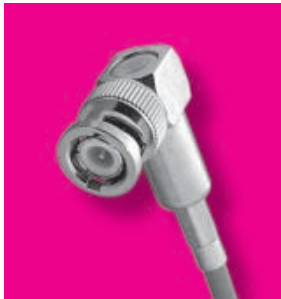

### RIGHT ANGLE CRIMP/CRIMP PLUG — MINIATURE CABLE

| P.N.                 | Cable Group | Finish | Insulation | Impedance | Crimp Tool |
|----------------------|-------------|--------|------------|-----------|------------|
| <b>Brass Shell</b>   |             |        |            |           |            |
| 112198               | 05          | Nickel | Delrin     | 50        | B          |
| 112199               | 06          | Nickel | Delrin     | 75        | B          |
| <b>Diecast Shell</b> |             |        |            |           |            |
| 112200               | 05          | Nickel | Delrin     | 50        | B          |
| 112201               | 06          | Nickel | Delrin     | 75        | B          |

Remark: With teflon sleeve Hex. crimp size .178" Crimp/Crimp Type

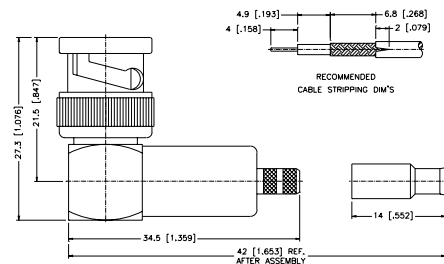

For Reverse Polarized connectors, add RP to standard part number. Contact Connex marketing for availability.  
For Crimp Tool information, see page 183.

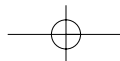

## JACK CRIMP ATTACHMENTS FOR FLEXIBLE CABLE

For Cable Group Legend, see page 69

### STRAIGHT CRIMP JACK — STANDARD CABLE

| P.N.     | Cable Group | Finish | Insulation | Impedance | Crimp Tool |
|----------|-------------|--------|------------|-----------|------------|
| Captured |             |        |            |           |            |
| 112144   | 01          | Nickel | Teflon     | 50        | A          |
| 112148   | 01          | Nickel | Delrin     | 50        | A          |
| 112513   | 01A         | Nickel | Delrin     | 50        | A          |
| 112598   | 01B         | Nickel | Teflon     | 50        | A          |
| 112146   | 03          | Nickel | Teflon     | 50        | A          |
| 112147   | 03          | Nickel | Teflon     | 75        | A          |
| 112150   | 03          | Nickel | Delrin     | 50        | A          |
| 112649   | 03A         | Nickel | Teflon     | 75        | A          |
| 112605   | 07B         | Nickel | Teflon     | 50        | A          |
| 112603   | 07C         | Nickel | Teflon     | 50        | D          |
| 112965*  | 08A         | Nickel | Teflon     | 75        | H          |
| 112966*  | 08B         | Nickel | Teflon     | 75        | E          |
| 112628   | 15          | Nickel | Teflon     | 75        | E          |
| 112973*  | 18          | Nickel | Teflon     | 75        | A          |
| 112974*  | 19          | Nickel | Teflon     | 75        | B          |

\*Center contact .052" diameter, 30µ" Au. True 75 ohm. Use .044 hex or 12-indent crimp

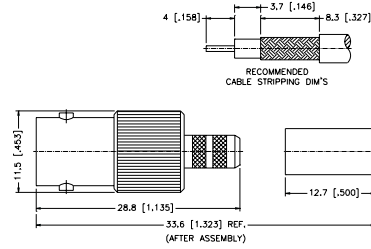

### STRAIGHT CRIMP JACK — PLENUM CABLE

| P.N.            | Cable Group | Finish | Insulation | Impedance | Crimp Tool |
|-----------------|-------------|--------|------------|-----------|------------|
| Teflon/Captured |             |        |            |           |            |
| 112152          | 02          | Nickel | Teflon     | 50        | A          |
| 112155          | 04          | Nickel | Teflon     | 75        | A          |
| 112645          | 04A         | Nickel | Teflon     | 75        | A          |

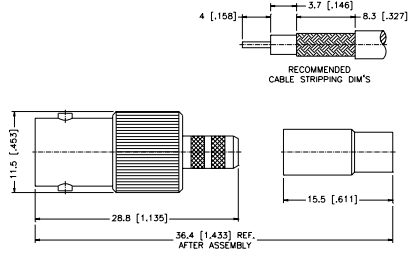
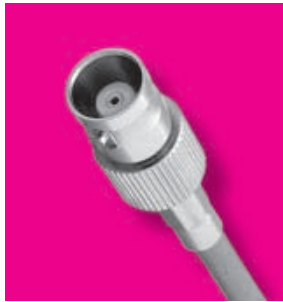

### STRAIGHT CRIMP JACK — MINIATURE AND SEMI-RIGID CABLE

| P.N.   | Cable Group | Finish      | Insulation | Impedance | Crimp Tool |
|--------|-------------|-------------|------------|-----------|------------|
| 112160 | 05          | Nickel      | Delrin     | 50        | B          |
| 112529 | 05A         | Nickel      | Teflon     | 50        | B          |
| 112161 | 06          | Nickel      | Delrin     | 75        | B          |
| 112647 | 06A         | Nickel      | Delrin     | 75        | B          |
| 112618 | 10          | Nickel/Gold | Teflon     | 50        | N/A        |
| 112615 | 11          | Nickel/Gold | Teflon     | 50        | N/A        |
| 112631 | 14          | Nickel      | Delrin     | 50        | B          |
| 112559 | 16          | Nickel      | Delrin     | 75        | B          |

Remark: With teflon sleeve, Hex crimp size .178"

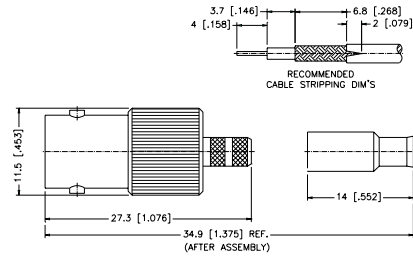

### BULKHEAD CRIMP JACK — SNAP-IN PANEL

| P.N.   | Cable Group | Finish | Insulation | Impedance | Crimp Tool |
|--------|-------------|--------|------------|-----------|------------|
| 112636 | 05          | Nickel | Teflon     | 50        | B          |

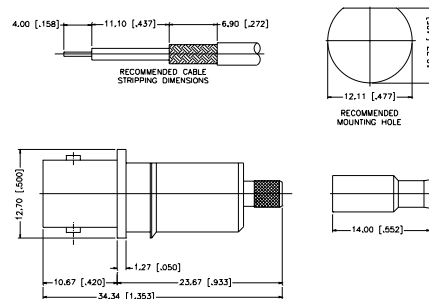



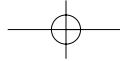

## BULKHEAD JACK CRIMP ATTACHMENTS FOR FLEXIBLE CABLE

For Cable Group Legend, see page 69

### BULKHEAD CRIMP JACK — STANDARD CABLE

| P.N.                       | Cable Group | Finish | Insulation | Impedance | Crimp Tool |
|----------------------------|-------------|--------|------------|-----------|------------|
| <b>Teflon/Captured</b>     |             |        |            |           |            |
| 112202                     | 01          | Nickel | Teflon     | 50        | A          |
| 112505                     | 01A         | Nickel | Teflon     | 50        | A          |
| 112600                     | 01B         | Nickel | Teflon     | 50        | A          |
| 112204                     | 03          | Nickel | Teflon     | 50        | A          |
| 112205                     | 03          | Nickel | Teflon     | 75        | A          |
| 112630                     | 03A         | Nickel | Teflon     | 75        | A          |
| 112602                     | 07B         | Nickel | Teflon     | 50        | A          |
| 112604                     | 07C         | Nickel | Teflon     | 50        | L          |
| 112662                     | 08A         | Nickel | Teflon     | 75        | E          |
| 112982                     | 08A         | Nickel | Teflon     | 75        | E          |
| 112593                     | 08B         | Nickel | Teflon     | 50        | E          |
| 112629                     | 15          | Nickel | Teflon     | 75        | E          |
| <b>Delrin/Non Captured</b> |             |        |            |           |            |
| 112206                     | 01          | Nickel | Delrin     | 50        | A          |
| 112208                     | 03          | Nickel | Delrin     | 50        | A          |
| 112209                     | 03          | Nickel | Delrin     | 75        | A          |

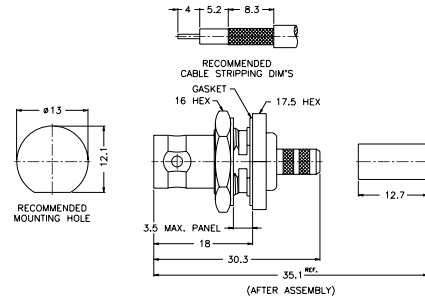

Remark: 3.5 [.138] Max. panel thickness  
 \*Center contact .053" diameter, 30 $\mu$ " Au.  
 True 75 ohm. Use .044 hex or 12-indent crimp

### BULKHEAD CRIMP JACK — STANDARD CABLE

| P.N.                   | Cable Group | Finish | Insulation | Impedance | Crimp Tool |
|------------------------|-------------|--------|------------|-----------|------------|
| <b>Teflon/Captured</b> |             |        |            |           |            |
| 112210                 | 01          | Nickel | Teflon     | 50        | A          |
| 112213                 | 03          | Nickel | Teflon     | 75        | A          |

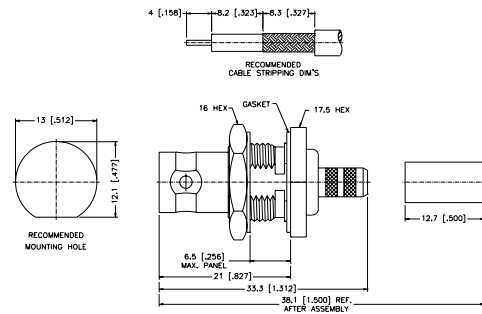

Remark: 6.5 [.256] Max. panel thickness

### BULKHEAD CRIMP JACK — PLENUM CABLE

| P.N.                   | Cable Group | Finish | Insulation | Impedance | Crimp Tool |
|------------------------|-------------|--------|------------|-----------|------------|
| <b>Teflon/Captured</b> |             |        |            |           |            |
| 112218                 | 02          | Nickel | Teflon     | 50        | A          |
| 112221                 | 04          | Nickel | Teflon     | 75        | A          |

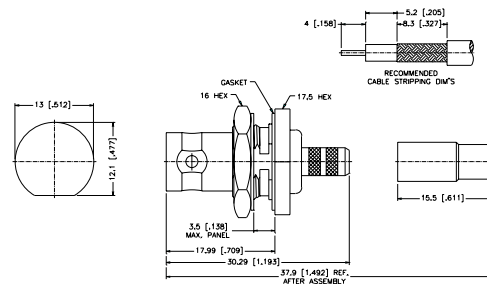

Remark: 3.5 [.138] Max. panel thickness

For Reverse Polarized connectors, add RP to standard part number. Contact Connex marketing for availability.  
 For Crimp Tool information, see page 183.

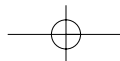

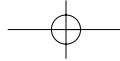

## BULKHEAD JACK CRIMP ATTACHMENTS FOR FLEXIBLE CABLE

For Cable Group Legend, see page 69

### BULKHEAD CRIMP JACK — PLENUM CABLE

| P.N.            | Cable Group | Finish | Insulation | Impedance | Crimp Tool |
|-----------------|-------------|--------|------------|-----------|------------|
| Teflon/Captured |             |        |            |           |            |
| 112226          | 02          | Nickel | Teflon     | 50        | A          |
| 112229          | 04          | Nickel | Teflon     | 75        | A          |

Remark: 6.5 [.256] Max. panel thickness

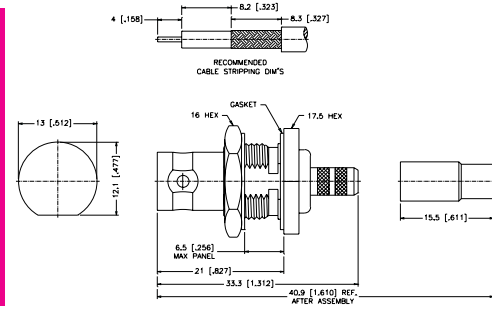

### BULKHEAD CRIMP JACK — MINIATURE CABLE

| P.N.        | Cable Group | Finish | Insulation | Impedance | Crimp Tool |
|-------------|-------------|--------|------------|-----------|------------|
| 112234      | 05          | Nickel | Delrin     | 50        | B          |
| 112517      | 05A         | Nickel | Delrin     | 50        | B          |
| 112635      | 05A         | Nickel | Teflon     | 50        | C          |
| FRONT MOUNT |             |        |            |           |            |
| 112235      | 06          | Nickel | Delrin     | 75        | B          |
| 112654      | 06          | Nickel | Teflon     | 75        | B          |
| FRONT MOUNT |             |        |            |           |            |
| 112648      | 06A         | Nickel | Delrin     | 75        | B          |
| 112522      | 14          | Nickel | Delrin     | 50        | B          |
| 112568      | 16          | Nickel | Teflon     | 75        | B          |
| 112970*     | 18          | Nickel | Teflon     | 75        | A          |
| 112969*     | 19          | Nickel | Teflon     | 75        | B          |

\*Center contact .052" diameter, 30μ" Au, true 75 ohm. Use .044 Hex. crimp or 12-indent crimp.

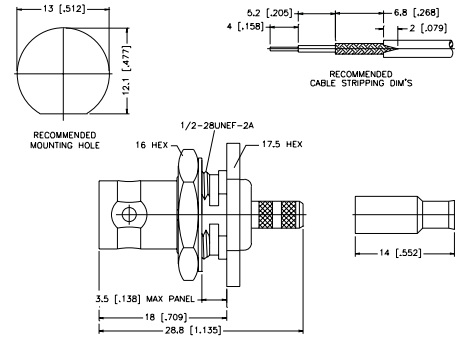

|             |     |        |        |    |   |
|-------------|-----|--------|--------|----|---|
| 112587      | 05  | Nickel | Teflon | 50 | B |
| FRONT MOUNT |     |        |        |    |   |
| 112634      | 05A | Nickel | Teflon | 50 | C |
| FRONT MOUNT |     |        |        |    |   |

Remark: With teflon sleeve, Hex. crimp size .178", 3.5 [.138] Max. panel thickness

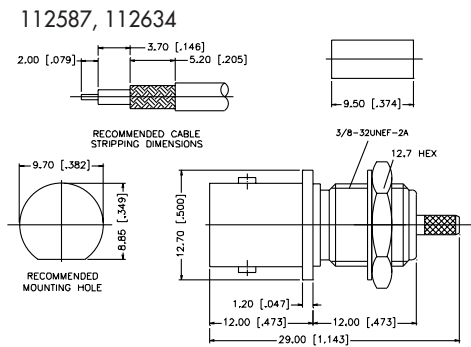

### BULKHEAD SOLDER JACK — SEMI-RIGID CABLE

| P.N.        | Cable Group | Finish      | Insulation | Impedance | Crimp Tool |
|-------------|-------------|-------------|------------|-----------|------------|
| 112581      | 10          | Nickel/Gold | Teflon     | 50        | N/A        |
| 112580      | 11          | Nickel/Gold | Teflon     | 50        | N/A        |
| 112609      | 11          | Nickel/Gold | Teflon     | 50        | N/A        |
| FRONT MOUNT |             |             |            |           |            |
| 112632      | 11          | Nickel/Gold | Teflon     | 75        | N/A        |
| FRONT MOUNT |             |             |            |           |            |

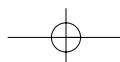
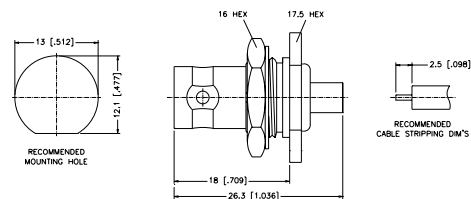

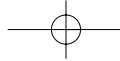

## BULKHEAD JACK CRIMP ATTACHMENTS FOR FLEXIBLE CABLE

For Cable Group Legend, see page 69

### BULKHEAD ISOLATED CRIMP JACK — STANDARD CABLE

| P.N.            | Cable Group | Finish | Insulation | Impedance | Crimp Tool |
|-----------------|-------------|--------|------------|-----------|------------|
| Teflon/Captured |             |        |            |           |            |
| 112236          | 01          | Nickel | Teflon     | 50        | A          |
| 112652          | 01A         | Nickel | Teflon     | 50        | A          |
| 112238          | 03          | Nickel | Teflon     | 50        | A          |
| 112239          | 03          | Nickel | Teflon     | 75        | A          |

Remark: 6.0 [.236] Max. panel thickness

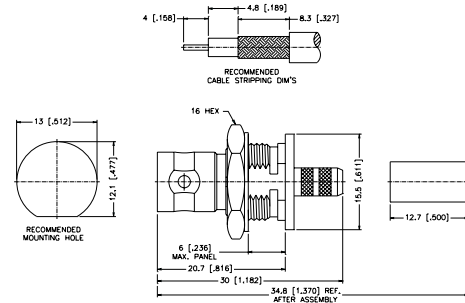
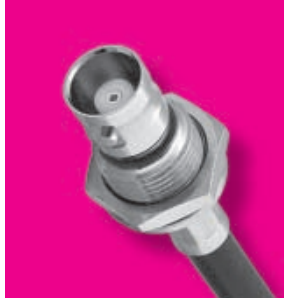

### BULKHEAD ISOLATED CRIMP JACK — PLENUM CABLE

| P.N.   | Cable Group | Finish | Insulation | Impedance | Crimp Tool |
|--------|-------------|--------|------------|-----------|------------|
| 112244 | 02          | Nickel | Teflon     | 50        | A          |
| 112247 | 04          | Nickel | Teflon     | 75        | A          |

Remark: 6.0 [.236] Max. panel thickness

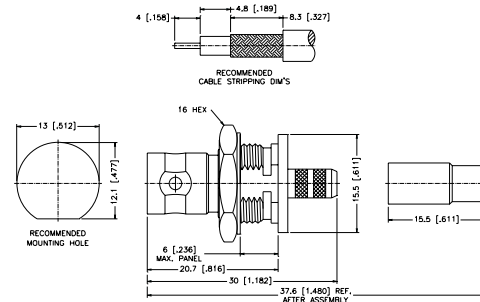
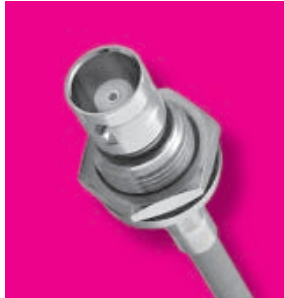

### BULKHEAD ISOLATED CRIMP JACK — MINIATURE CABLE

| P.N.   | Cable Group | Finish | Insulation | Impedance | Crimp Tool |
|--------|-------------|--------|------------|-----------|------------|
| 112252 | 05          | Nickel | Teflon     | 50        | B          |
| 112253 | 06          | Nickel | Teflon     | 75        | B          |

Remark: 6.0 [.236] Max. panel thickness

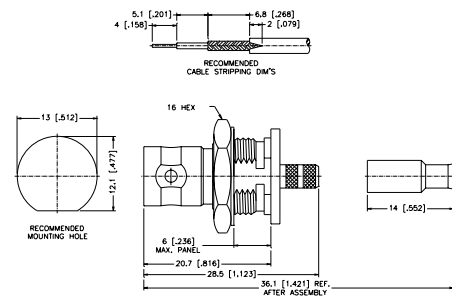

For Reverse Polarized connectors, add RP to standard part number. Contact Connex marketing for availability. For Crimp Tool information, see page 183.

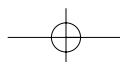

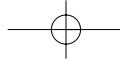

**PANEL JACK CRIMP ATTACHMENTS FOR FLEXIBLE CABLE/RECEPTACLE** For Cable Group Legend, see page 69

**PANEL CRIMP JACK — STANDARD CABLE**

| P.N.            | Cable Group | Finish | Insulation | Impedance | Crimp Tool |
|-----------------|-------------|--------|------------|-----------|------------|
| Teflon/Captured |             |        |            |           |            |
| 112272          | 01          | Nickel | Teflon     | 50        | A          |
| 112527          | 01A         | Nickel | Delrin     | 50        | A          |
| 112274          | 03          | Nickel | Teflon     | 50        | A          |
| 112275          | 03          | Nickel | Teflon     | 75        | A          |

Remark: 5.0 [.197] Max. panel thickness

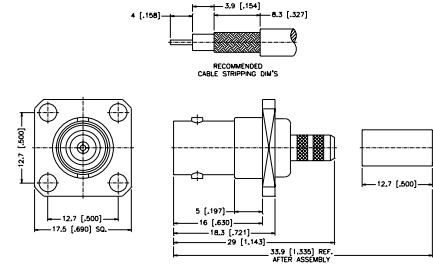

**PANEL CRIMP JACK — PLENUM CABLE**

| P.N.            | Cable Group | Finish | Insulation | Impedance | Crimp Tool |
|-----------------|-------------|--------|------------|-----------|------------|
| Teflon/Captured |             |        |            |           |            |
| 112280          | 02          | Nickel | Teflon     | 50        | A          |
| 112283          | 04          | Nickel | Teflon     | 75        | A          |

Remark: 5.0 [.197] Max. panel thickness

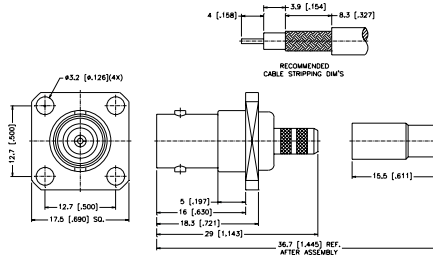
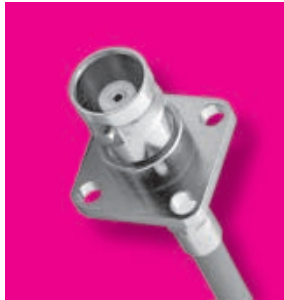

**PANEL CRIMP JACK — MINIATURE AND SEMI-RIGID CABLE**

| P.N.   | Cable Group | Finish      | Insulation | Impedance | Crimp Tool |
|--------|-------------|-------------|------------|-----------|------------|
| 112288 | 05          | Nickel      | Delrin     | 50        | B          |
| 112530 | 05A         | Nickel      | Delrin     | 50        | B          |
| 112289 | 06          | Nickel      | Delrin     | 75        | B          |
| 112619 | 10          | Nickel/Gold | Teflon     | 50        | N/A        |
| 112616 | 11          | Nickel/Gold | Teflon     | 50        | N/A        |

Remark: 5.0 [.197] Max. panel thickness

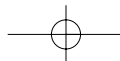
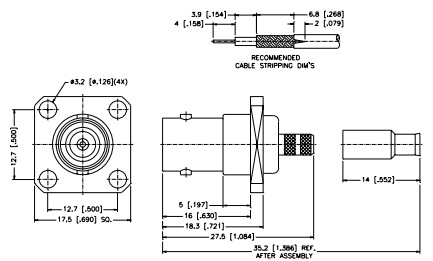

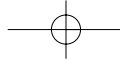

## CLAMP ATTACHMENTS FOR FLEXIBLE CABLE

For Cable Group Legend, see page 69

### STRAIGHT CLAMP PLUG — CAPTIVE CONTACT

| P.N.        | Cable Group | Finish | Insulation | Impedance | Crimp Tool |
|-------------|-------------|--------|------------|-----------|------------|
| Brass shell |             |        |            |           |            |
| 112332      | 01          | Nickel | Delrin     | 50        | N/A        |
| 112334      | 03          | Nickel | Delrin     | 50        | N/A        |
| 112335      | 03          | Nickel | Delrin     | 75        | N/A        |
| 112531      | 07          | Nickel | Teflon     | 50        | N/A        |
| 112558      | 07E         | Nickel | Teflon     | 75        | N/A        |
| 112657      | 07F         | Nickel | Teflon     | 75        | N/A        |

Remark: Barrel O.D. = 12.5 mm

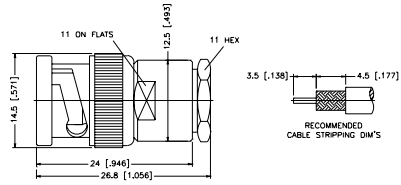
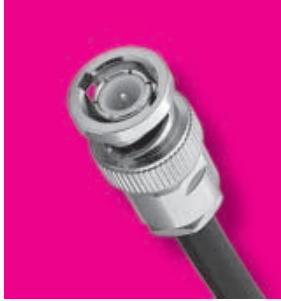

### STRAIGHT CLAMP PLUG — CAPTIVE CONTACT

| P.N.          | Cable Group | Finish | Insulation | Impedance | Crimp Tool |
|---------------|-------------|--------|------------|-----------|------------|
| Brass Shell   |             |        |            |           |            |
| 112348        | 01          | Nickel | Delrin     | 50        | N/A        |
| 112350        | 03          | Nickel | Delrin     | 50        | N/A        |
| 112351        | 03          | Nickel | Delrin     | 75        | N/A        |
| 112477        | 06          | Nickel | Teflon     | 75        | N/A        |
| Diecast Shell |             |        |            |           |            |
| 112352        | 01          | Nickel | Delrin     | 50        | N/A        |
| 112354        | 03          | Nickel | Delrin     | 50        | N/A        |

Remark: UG-88/U, UG-260/U

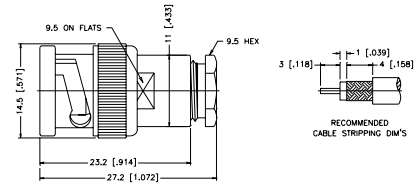

### RIGHT ANGLE CLAMP PLUG

| P.N.        | Cable Group | Finish | Insulation | Impedance | Crimp Tool |
|-------------|-------------|--------|------------|-----------|------------|
| Brass Shell |             |        |            |           |            |
| 112356      | 01          | Nickel | Delrin     | 50        | N/A        |
| 112358      | 03          | Nickel | Delrin     | 50        | N/A        |
| 112359      | 03          | Nickel | Delrin     | 75        | N/A        |
| 112360      | 02          | Nickel | Delrin     | 50        | N/A        |
| 112362      | 04          | Nickel | Delrin     | 50        | N/A        |
| 112363      | 04          | Nickel | Delrin     | 75        | N/A        |

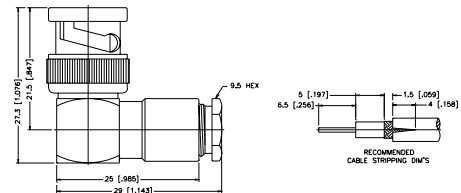
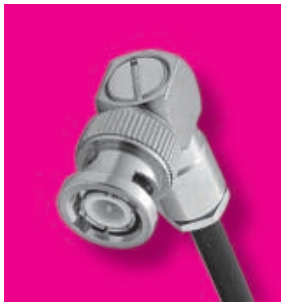

### STRAIGHT CLAMP JACK — CAPTIVE CONTACT

| P.N.   | Cable Group | Finish | Insulation | Impedance | Crimp Tool |
|--------|-------------|--------|------------|-----------|------------|
| 112372 | 01          | Nickel | Teflon     | 50        | N/A        |
| 112374 | 03          | Nickel | Teflon     | 50        | N/A        |
| 112375 | 03          | Nickel | Teflon     | 75        | N/A        |
| 112376 | 02          | Nickel | Teflon     | 50        | N/A        |
| 112378 | 04          | Nickel | Teflon     | 50        | N/A        |
| 112379 | 04          | Nickel | Teflon     | 75        | N/A        |
| 112642 | 07          | Nickel | Teflon     | 50        | N/A        |

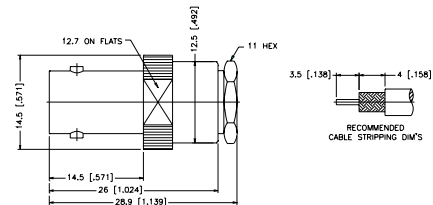

For Reverse Polarized connectors, add RP to standard part number. Contact Connex marketing for availability.  
For Crimp Tool information, see page 183.

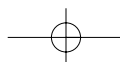

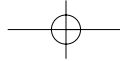

## CLAMP ATTACHMENTS FOR FLEXIBLE CABLE

For Cable Group Legend, see page 69

### BULKHEAD CLAMP JACK — CAPTIVE CONTACT

| P.N.   | Cable Group | Finish | Insulation | Impedance | Crimp Tool |
|--------|-------------|--------|------------|-----------|------------|
| 112577 | 01          | Nickel | Teflon     | 50        | N/A        |
| 112612 | 05          | Nickel | Teflon     | 50        | N/A        |
| 112613 | 06          | Nickel | Teflon     | 75        | N/A        |

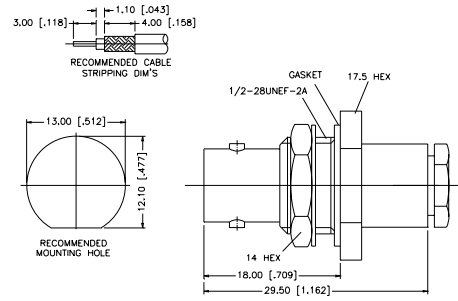

## TWIST-ON ATTACHMENTS FOR FLEXIBLE CABLE

### TWIST-ON PLUG

| P.N.                 | Cable Group | Finish | Insulation | Impedance | Crimp Tool |
|----------------------|-------------|--------|------------|-----------|------------|
| <b>Brass Shell</b>   |             |        |            |           |            |
| 112292               | 01          | Nickel | Delrin     | 50        | N/A        |
| 112294               | 03          | Nickel | Delrin     | 50        | N/A        |
| 112295               | 03          | Nickel | Delrin     | 75        | N/A        |
| 112296               | 02          | Nickel | Delrin     | 50        | N/A        |
| 112298               | 04          | Nickel | Delrin     | 50        | N/A        |
| 112299               | 04          | Nickel | Delrin     | 75        | N/A        |
| 112485               | 08          | Nickel | Delrin     | 75        | N/A        |
| <b>Diecast Shell</b> |             |        |            |           |            |
| 112300               | 01          | Nickel | Delrin     | 50        | N/A        |
| 112302               | 03          | Nickel | Delrin     | 50        | N/A        |
| 112303               | 03          | Nickel | Delrin     | 75        | N/A        |
| 112486               | 08          | Nickel | Delrin     | 75        | N/A        |

Remark: Only for solid center conductor cable

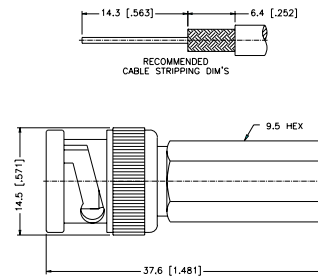

### TWIST-ON JACK

| P.N.   | Cable Group | Finish | Insulation | Impedance | Crimp Tool |
|--------|-------------|--------|------------|-----------|------------|
| 112308 | 01          | Nickel | Delrin     | 50        | N/A        |
| 112310 | 03          | Nickel | Delrin     | 50        | N/A        |
| 112312 | 02          | Nickel | Delrin     | 50        | N/A        |
| 112314 | 04          | Nickel | Delrin     | 50        | N/A        |

Remark: Only for solid center conductor cable

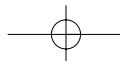
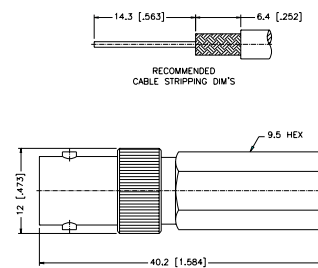

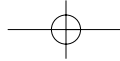

## TWIST-ON ATTACHMENTS FOR FLEXIBLE CABLE

For Cable Group Legend, see page 69

### RIGHT ANGLE TWIST-ON PLUG

| P.N.          | Cable Group | Finish | Insulation | Impedance | Crimp Tool |
|---------------|-------------|--------|------------|-----------|------------|
| Diecast Shell |             |        |            |           |            |
| 112324        | 01          | Nickel | Delrin     | 50        | N/A        |
| 112326        | 03          | Nickel | Delrin     | 50        | N/A        |
| 112327        | 03          | Nickel | Delrin     | 75        | N/A        |
| 112328        | 02          | Nickel | Delrin     | 50        | N/A        |
| 112330        | 04          | Nickel | Delrin     | 50        | N/A        |

Remark: Only for solid center conductor cable

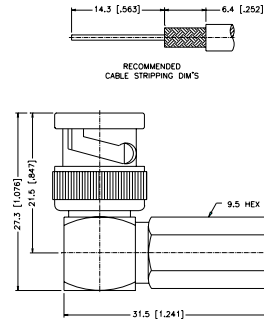

## WEDGE COMPRESSION ATTACHMENTS FOR FLEXIBLE CABLE

### WEDGE COMPRESSION PLUG

| P.N.        | Cable Group | Finish | Insulation | Impedance | Crimp Tool |
|-------------|-------------|--------|------------|-----------|------------|
| Brass Shell |             |        |            |           |            |
| 112380      | 01          | Nickel | Delrin     | 50        | N/A        |
| 112382      | 03          | Nickel | Delrin     | 50        | N/A        |
| 112383      | 03          | Nickel | Delrin     | 75        | N/A        |
| 112384      | 02          | Nickel | Delrin     | 50        | N/A        |
| 112386      | 04          | Nickel | Delrin     | 50        | N/A        |
| 112387      | 04          | Nickel | Delrin     | 75        | N/A        |

Remark: With wedge pin

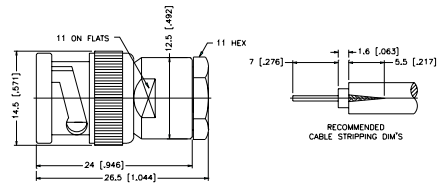

### WEDGE COMPRESSION JACK

| P.N.   | Cable Group | Finish | Insulation | Impedance | Crimp Tool |
|--------|-------------|--------|------------|-----------|------------|
| 112396 | 01          | Nickel | Teflon     | 50        | N/A        |
| 112398 | 03          | Nickel | Teflon     | 50        | N/A        |
| 112399 | 03          | Nickel | Teflon     | 75        | N/A        |
| 112400 | 02          | Nickel | Teflon     | 50        | N/A        |
| 112402 | 04          | Nickel | Teflon     | 50        | N/A        |
| 112403 | 04          | Nickel | Teflon     | 75        | N/A        |

Remark: With wedge contact

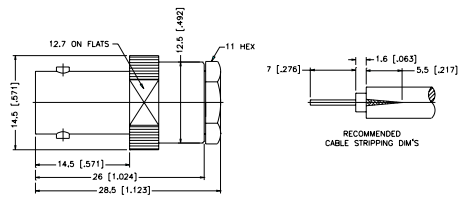

For Reverse Polarized connectors, add RP to standard part number. Contact Connex marketing for availability.  
For Crimp Tool information, see page 183.

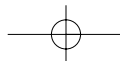

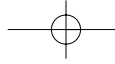

## BULKHEAD RECEPTACLE/SOLDER POT TERMINALS

For Cable Group Legend, see page 69

### BULKHEAD RECEPTACLE PLUG

| P.N.        | Cable Group | Finish | Insulation | Impedance | Crimp Tool |
|-------------|-------------|--------|------------|-----------|------------|
| Brass Shell |             |        |            |           |            |
| 112420      | N/A         | Nickel | Delrin     | 50        | N/A        |
| 112421      | N/A         | Nickel | Delrin     | 75        | N/A        |

Remark: 4.5 [1.77] Max. panel thickness

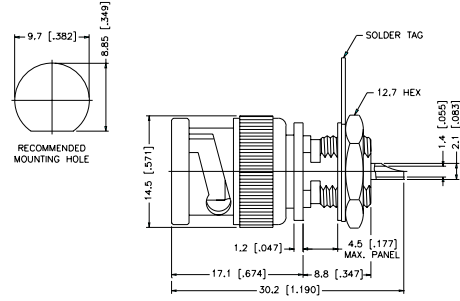

### BULKHEAD RECEPTACLE JACK

| P.N.   | Cable Group | Finish | Insulation | Impedance | Crimp Tool |
|--|-------------|--------|------------|-----------|------------|
| L1 = 3.2 [0.126] Max. panel thickness, L = 26.7 [1.05] |             |        |            |           |            |
| 112424   | N/A         | Nickel | Delrin     | 50        | N/A        |
| 112424T  | N/A         | Nickel | Teflon     | 50        | N/A        |
| 112575 N/A Nickel Delrin 50 N/A DIE CAST BODY          |             |        |            |           |            |
| 112575-75 N/A Nickel Delrin 75 N/A DIE CAST BODY       |             |        |            |           |            |
| 112425   | N/A         | Nickel | Delrin     | 75        | N/A        |
| L1 = 6.5 [0.256] Max. panel thickness, L = 30.0 [1.18] |             |        |            |           |            |
| 112426   | N/A         | Nickel | Delrin     | 50        | N/A        |
| 112427   | N/A         | Nickel | Delrin     | 75        | N/A        |

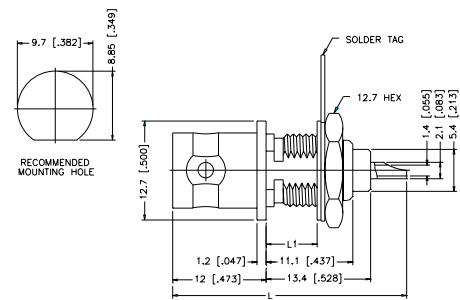

|  |     |        |        |    |     |
|--|-----|--------|--------|----|-----|
| L1 = 9.5 [0.374] Max. panel thickness, L = 33.0 [1.30] |     |        |        |    |     |
| 112428   | N/A | Nickel | Delrin | 50 | N/A |
| 112429   | N/A | Nickel | Delrin | 75 | N/A |

### BULKHEAD RECEPTACLE ISOLATED JACK

| P.N.   | Cable Group | Finish | Insulation | Impedance | Crimp Tool |
|--------|-------------|--------|------------|-----------|------------|
| 112431 | N/A         | Nickel | ABS        | 50        | N/A        |
| 112432 | N/A         | Nickel | ABS        | 75        | N/A        |

Remark: Isolated from ground,  
3.2 [0.126] Max. panel thickness

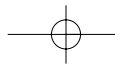
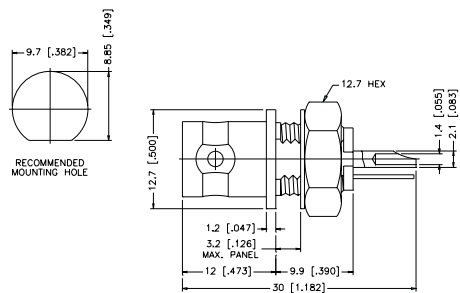



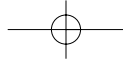

## BULKHEAD RECEPTACLE/SOLDER POT TERMINALS

For Cable Group Legend, see page 69

### BULKHEAD RECEPTACLE ISOLATED JACK — REAR MOUNT

| P.N.   | Cable Group | Finish | Insulation | Impedance | Crimp Tool |
|--------|-------------|--------|------------|-----------|------------|
| 112624 | N/A         | Nickel | Teflon     | 50        | N/A        |

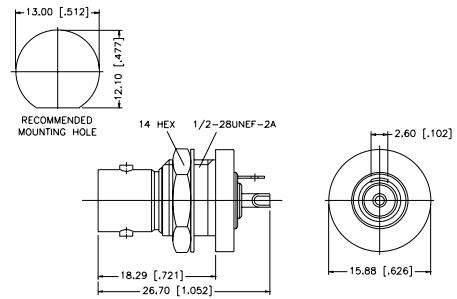

### BULKHEAD RECEPTACLE — PRESS FIT

| P.N.   | Cable Group | Finish | Insulation | Impedance | Crimp Tool |
|--------|-------------|--------|------------|-----------|------------|
| 112579 | N/A         | Nickel | Teflon     | 50        | N/A        |

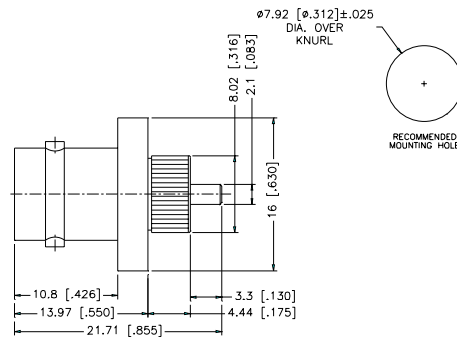

### BULKHEAD RECEPTACLE — PRESS FIT

| P.N.   | Cable Group | Finish | Insulation | Impedance | Crimp Tool |
|--------|-------------|--------|------------|-----------|------------|
| 112607 | N/A         | Nickel | Teflon     | 50        | N/A        |

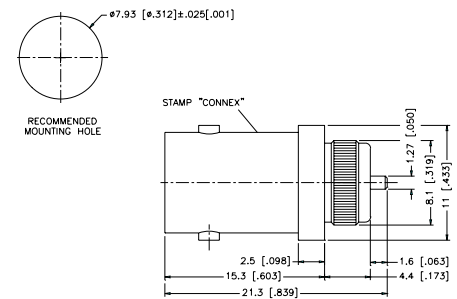

For Reverse Polarized connectors, add RP to standard part number. Contact Connex marketing for availability.  
For Crimp Tool information, see page 183.

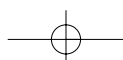

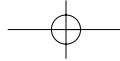

## PANEL RECEPTACLES

For Cable Group Legend, see page 69

### PANEL RECEPTACLE JACK

| P.N.                   | Cable Group | Finish | Insulation | Impedance | Crimp Tool |
|------------------------|-------------|--------|------------|-----------|------------|
| 112290                 | N/A         | Nickel | Teflon     | 50        | N/A        |
| 112291                 | N/A         | Nickel | Teflon     | 75        | N/A        |
| 112492                 | N/A         | Nickel | Teflon     | 50        | N/A        |
| FLUSH REAR             |             |        |            |           |            |
| 112511                 | N/A         | Nickel | Teflon     | 50        | N/A        |
| FLUSH REAR 4-40 SCREWS |             |        |            |           |            |

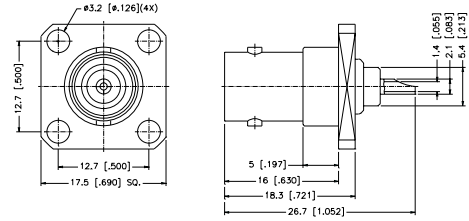

### PANEL RECEPTACLE PLUG

| P.N.   | Cable Group | Finish | Insulation | Impedance | Crimp Tool |
|--------|-------------|--------|------------|-----------|------------|
| 112653 | N/A         | Nickel | Teflon     | 50        | A          |

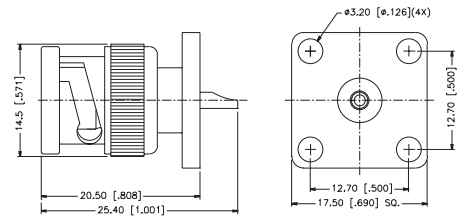

### PANEL RECEPTACLE JACK — EXPOSED TFE TYPE

| P.N.    | Cable Group | Finish | Insulation | Impedance | Crimp Tool |
|---------|-------------|--------|------------|-----------|------------|
| 112524N | N/A         | Nickel | Teflon     | 50        | N/A        |
| 112524S | N/A         | Silver | Teflon     | 50        | N/A        |

NOTE: Consult factory for other lengths available

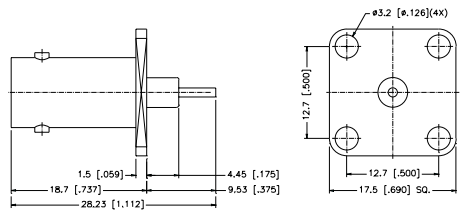

### PANEL RECEPTACLE — EXPOSED TEFLON — GASKET SEAL

| P.N.   | Cable Group | Finish | Insulation | Impedance | Crimp Tool |
|--------|-------------|--------|------------|-----------|------------|
| 112639 | N/A         | Nickel | Teflon     | 50        | N/A        |

Note: Consult factory for other lengths available.

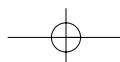
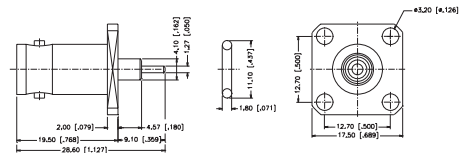

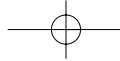

# PRINTED CIRCUIT BOARD/RECEPTACLES

For Cable Group Legend, see page 69

## STRAIGHT PCB MOUNT JACK

| P.N.   | Cable Group | Finish | Insulation | Impedance | Crimp Tool |
|--------|-------------|--------|------------|-----------|------------|
| 112404 | N/A         | Nickel | Teflon     | 50        | N/A        |
| 112405 | N/A         | Nickel | Teflon     | 75        | N/A        |

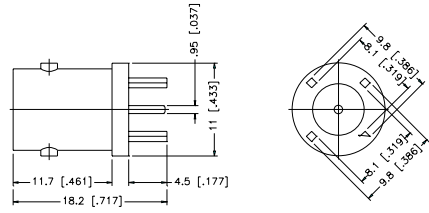

Mounting Hole Dia. see "TYPE C" page 185

## STRAIGHT PCB MOUNT JACK

| P.N.   | Cable Group | Finish | Insulation | Impedance | Crimp Tool |
|--------|-------------|--------|------------|-----------|------------|
| 112538 | N/A         | Nickel | Teflon     | 50        | N/A        |
| 112543 | N/A         | Nickel | Teflon     | 75        | N/A        |

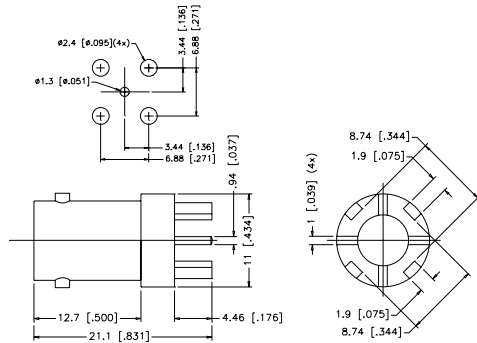

## STRAIGHT PCB MOUNT JACK

| P.N.   | Cable Group | Finish | Insulation | Impedance | Crimp Tool |
|--------|-------------|--------|------------|-----------|------------|
| 112515 | N/A         | Nickel | Teflon     | 50        | N/A        |
| 112591 | N/A         | Nickel | Teflon     | 50        | N/A        |

WATERPROOF

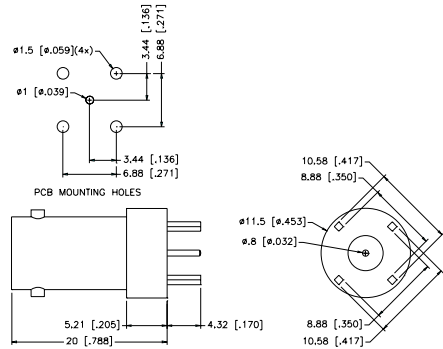

## STRAIGHT PCB MOUNT JACK

| P.N.      | Cable Group | Finish | Insulation | Impedance | Crimp Tool |
|-----------|-------------|--------|------------|-----------|------------|
| 112553    | N/A         | Nickel | Teflon     | 50        | N/A        |
| 112553-10 | N/A         | Nickel | Teflon     | 75        | N/A        |

WATERPROOF

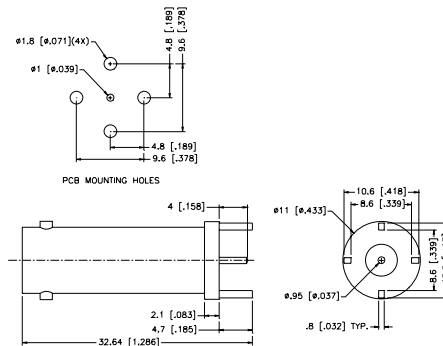

For Reverse Polarized connectors, add RP to standard part number. Contact Connex marketing for availability.  
For Crimp Tool information, see page 183.

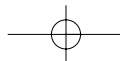

## PRINTED CIRCUIT BOARD/RECEPTACLES

For Cable Group Legend, see page 69

### STRAIGHT PCB MOUNT JACK — THREE LEGS

| P.N.   | Cable Group   | Finish | Insulation | Impedance | Crimp Tool |
|--------|---------------|--------|------------|-----------|------------|
| 112483 | N/A<br>3 LEGS | Nickel | Teflon     | 50        | N/A        |

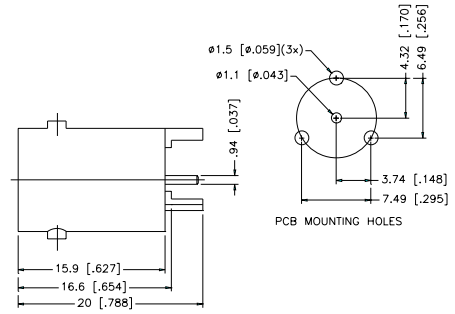

### STRAIGHT PCB MOUNT JACK

| P.N.   | Cable Group | Finish | Insulation | Impedance | Crimp Tool |
|--------|-------------|--------|------------|-----------|------------|
| 112586 | N/A         | Nickel | Teflon     | 75        | N/A        |

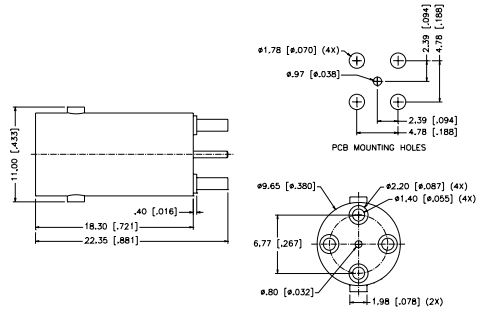

### STRAIGHT PCB MOUNT JACK

| P.N.   | Cable Group | Finish | Insulation | Impedance | Crimp Tool |
|--------|-------------|--------|------------|-----------|------------|
| 112406 | N/A         | Nickel | Teflon     | 50        | N/A        |
| 112407 | N/A         | Nickel | Teflon     | 75        | N/A        |

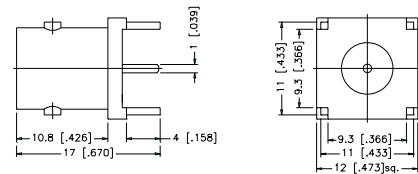

Mounting Hole Dia. see "TYPE F" page 185

### STRAIGHT PCB MOUNT JACK

| P.N.   | Cable Group | Finish | Insulation | Impedance | Crimp Tool |
|--------|-------------|--------|------------|-----------|------------|
| 112536 | N/A         | Nickel | Teflon     | 50        | N/A        |
| 112578 | N/A         | Nickel | Teflon     | 75        | N/A        |

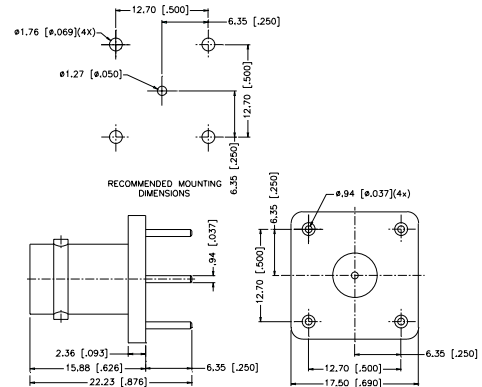

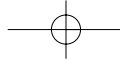

# PRINTED CIRCUIT BOARD/RECEPTACLES

For Cable Group Legend, see page 69

## STRAIGHT PCB EDGE MOUNT JACK — END LAUNCH

| P.N.          | Cable Group | Finish | Insulation | Impedance | Crimp Tool |
|---------------|-------------|--------|------------|-----------|------------|
| 112608        | N/A         | Nickel | Teflon     | 50        | N/A        |
| 112622        | N/A         | Nickel | Teflon     | 75        | N/A        |
| SQUARE FLANGE |             |        |            |           |            |

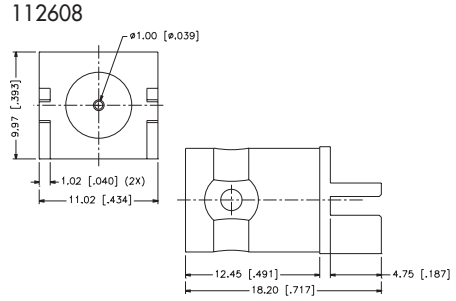
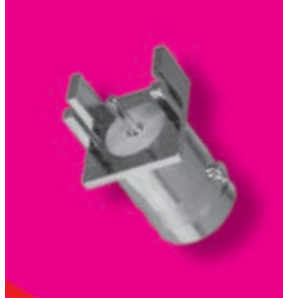

|              |     |        |        |    |     |
|--------------|-----|--------|--------|----|-----|
| 112640       | N/A | Nickel | Teflon | 50 | N/A |
| 112641       | N/A | Nickel | Teflon | 75 | N/A |
| ROUND FLANGE |     |        |        |    |     |

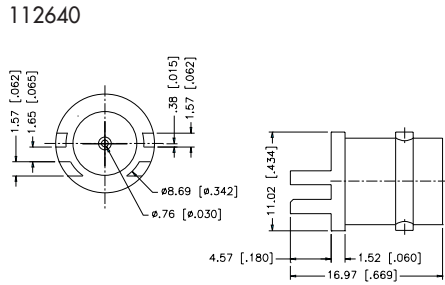

## BULKHEAD VERTICAL PCB RECEPTACLE — END LAUNCH

| P.N.   | Cable Group | Finish | Insulation | Impedance | Crimp Tool |
|--------|-------------|--------|------------|-----------|------------|
| 112633 | N/A         | Nickel | Teflon     | 50        | N/A        |

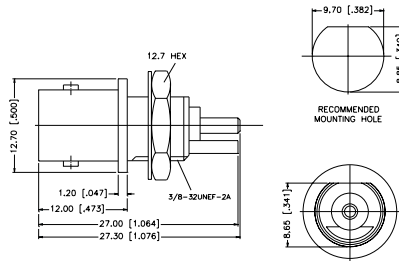

## COMMERCIAL STRAIGHT PCB MOUNT JACK

| P.N.          | Cable Group | Finish | Insulation    | Impedance | Crimp Tool |
|---------------|-------------|--------|---------------|-----------|------------|
| White Housing |             |        |               |           |            |
| 112408        | N/A         | Nickel | Polypropylene | 50        | N/A        |
| 112409        | N/A         | Nickel | Polypropylene | 75        | N/A        |
| Black Housing |             |        |               |           |            |
| 112410        | N/A         | Nickel | Polypropylene | 50        | N/A        |
| 112411        | N/A         | Nickel | Polypropylene | 75        | N/A        |

Remark: Add L to part number for Locking Legs

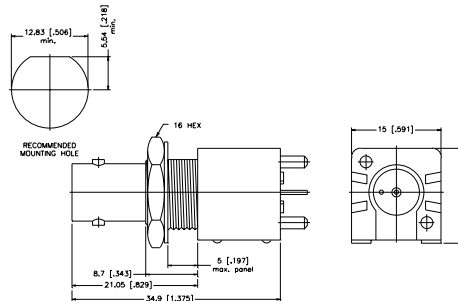

Mounting Hole Dia. see "TYPE G" page 185

For Reverse Polarized connectors, add RP to standard part number. Contact Connex marketing for availability.  
For Crimp Tool information, see page 183.

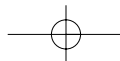

## PRINTED CIRCUIT BOARD/RECEPTACLES

For Cable Group Legend, see page 69

### COMMERCIAL STRAIGHT PCB MOUNT JACK — METAL BODY

| P.N.    | Cable Group | Finish | Insulation    | Impedance | Crimp Tool |
|---------|-------------|--------|---------------|-----------|------------|
| Diecast |             |        |               |           |            |
| 112488  | N/A         | Nickel | Polypropylene | 50        | N/A        |
| 112495  | N/A         | Nickel | Polypropylene | 75        | N/A        |

Note: Connectors are shipped with lock nut and washer

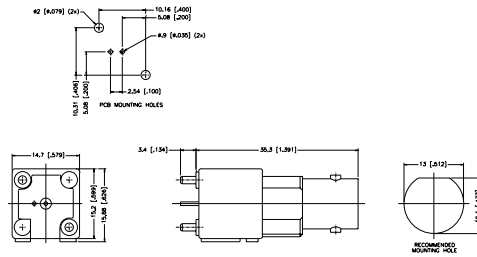
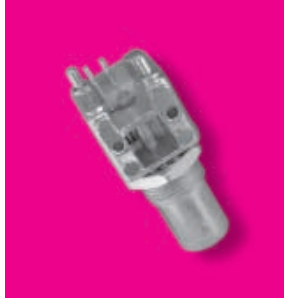

Mounting Hole Dia. see "TYPE G" page 185

### COMMERCIAL RIGHT ANGLE PCB MOUNT JACK

| P.N.                             | Cable Group | Finish | Insulation    | Impedance | Crimp Tool |
|----------------------------------|-------------|--------|---------------|-----------|------------|
| High Profile, 15.88 [.625] White |             |        |               |           |            |
| 112412                           | N/A         | Nickel | Polypropylene | 50        | N/A        |
| 112413                           | N/A         | Nickel | Polypropylene | 75        | N/A        |
| High profile, 15.88 [.625] Black |             |        |               |           |            |
| 112414                           | N/A         | Nickel | Polypropylene | 50        | N/A        |
| 112415                           | N/A         | Nickel | Polypropylene | 75        | N/A        |
| Low Profile, 13.1 [.516] White   |             |        |               |           |            |
| 112416                           | N/A         | Nickel | Polypropylene | 50        | N/A        |
| 112417                           | N/A         | Nickel | Polypropylene | 75        | N/A        |
| Low Profile, 13.1 [.516] Black   |             |        |               |           |            |
| 112418                           | N/A         | Nickel | Polypropylene | 50        | N/A        |
| 112419                           | N/A         | Nickel | Polypropylene | 75        | N/A        |

Remark: Add L to part number for Locking Legs  
Note: Connectors are shipped with lock nut and washer

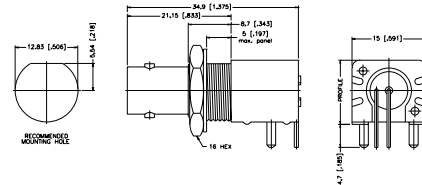

Mounting Hole Dia. see "TYPE H" page 185

### COMMERCIAL RIGHT ANGLE PCB MOUNT JACK — METAL BODY

| P.N.                       | Cable Group | Finish | Insulation    | Impedance | Crimp Tool |
|----------------------------|-------------|--------|---------------|-----------|------------|
| Diecast                    |             |        |               |           |            |
| High Profile, 15.88 [.625] |             |        |               |           |            |
| 112502                     | N/A         | Nickel | Polypropylene | 50        | N/A        |
| 112503                     | N/A         | Nickel | Polypropylene | 75        | N/A        |
| Low Profile, 13.1 [.516]   |             |        |               |           |            |
| 112487                     | N/A         | Nickel | Polypropylene | 50        | N/A        |
| 112494                     | N/A         | Nickel | Polypropylene | 75        | N/A        |

Note: Connectors are shipped with lock nut and washer

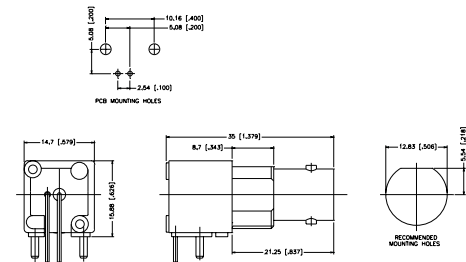

Mounting Hole Dia. see "TYPE H" page 185

### RIGHT ANGLE PCB MOUNT RECEPTACLE — METAL BODY

| P.N.   | Cable Group | Finish | Insulation | Impedance | Crimp Tool |
|--------|-------------|--------|------------|-----------|------------|
| 112659 | N/A         | Nickel | Teflon     | 50        | N/A        |

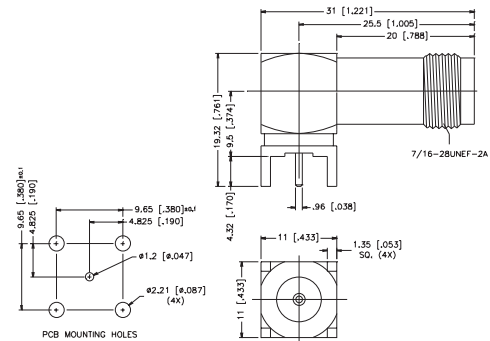

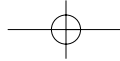

# BULKHEAD FEEDTHROUGH ADAPTERS

For Cable Group Legend, see page 69

## JACK-TO-JACK BULKHEAD ADAPTER

| P.N.   | Cable Group | Finish | Insulation | Impedance | Crimp Tool |
|--------|-------------|--------|------------|-----------|------------|
| 112433 | N/A         | Nickel | Delrin     | 50        | N/A        |
| 112434 | N/A         | Nickel | Delrin     | 75        | N/A        |

Remark: 8.0 mm [.315] Max. panel thickness, M55339/13-00492

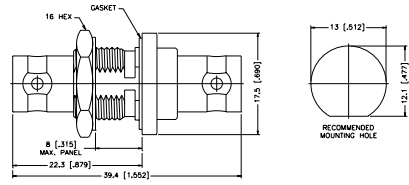

## JACK-TO-JACK BULKHEAD ADAPTER

| P.N.   | Cable Group | Finish | Insulation | Impedance | Crimp Tool |
|--------|-------------|--------|------------|-----------|------------|
| 112435 | N/A         | Nickel | Delrin     | 50        | N/A        |
| 112436 | N/A         | Nickel | Delrin     | 75        | N/A        |

Remark: 7.0 mm [.276] Max. panel thickness, UG-492A

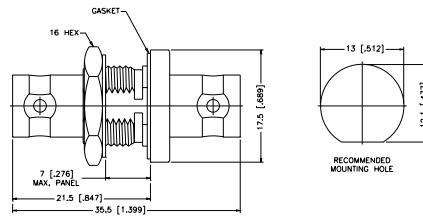

## JACK-TO-JACK BULKHEAD ADAPTER

| P.N.   | Cable Group | Finish | Insulation | Impedance | Crimp Tool |
|--------|-------------|--------|------------|-----------|------------|
| 112437 | N/A         | Nickel | Delrin     | 50        | N/A        |
| 112438 | N/A         | Nickel | Delrin     | 75        | N/A        |

Remark: Without gasket, 5.5 mm [.217] Max. panel thickness

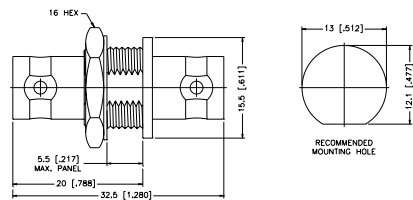

## JACK-TO-PLUG BULKHEAD ADAPTER — PUSH-ON

| P.N.   | Cable Group | Finish | Insulation | Impedance | Crimp Tool |
|--------|-------------|--------|------------|-----------|------------|
| 112532 | N/A         | Nickel | Teflon     | 75        | N/A        |

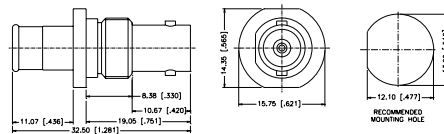

For Reverse Polarized connectors, add RP to standard part number. Contact Connex marketing for availability.  
For Crimp Tool information, see page 183.

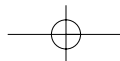

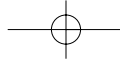

## BULKHEAD ISOLATED GROUND ADAPTERS

For Cable Group Legend, see page 69

### JACK-TO-JACK BULKHEAD — ISOLATED ADAPTER

| P.N.   | Cable Group | Finish | Insulation | Impedance | Crimp Tool |
|--------|-------------|--------|------------|-----------|------------|
| 112439 | N/A         | Nickel | Delrin     | 50        | N/A        |
| 112440 | N/A         | Nickel | Delrin     | 75        | N/A        |

Remark: With Isolated Bushing,  
4.5 mm [.177] Max. panel thickness

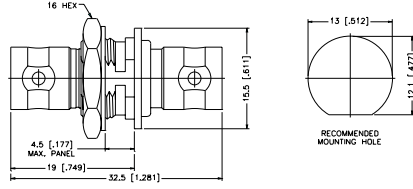

### JACK-TO-JACK BULKHEAD — ISOLATED ADAPTER

| P.N.   | Cable Group | Finish | Insulation | Impedance | Crimp Tool |
|--------|-------------|--------|------------|-----------|------------|
| 112443 | N/A         | Nickel | Delrin     | 50        | N/A        |
| 112444 | N/A         | Nickel | Delrin     | 75        | N/A        |

Remark: Isolated from ground,  
5.5 mm [.217] Max. panel thickness

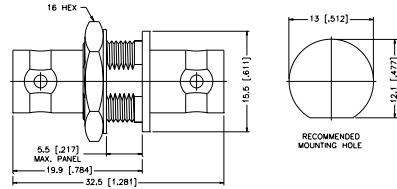

### DUAL PORT RIGHT ANGLE PCB MOUNT RECEPTACLE

| P.N.          | Cable Group | Finish | Insulation    | Impedance | Crimp Tool |
|---------------|-------------|--------|---------------|-----------|------------|
| WHITE HOUSING |             |        |               |           |            |
| 112660        | N/A         | Nickel | Polypropylene | 50        | N/A        |
| BLACK HOUSING |             |        |               |           |            |
| 112661        | N/A         | Nickel | Polypropylene | 50        | N/A        |

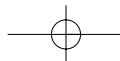
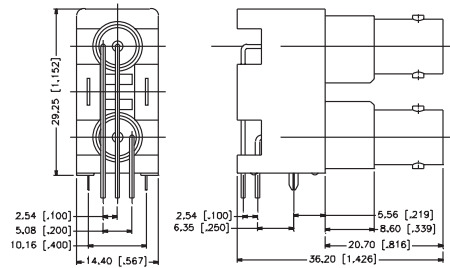



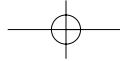

## ADAPTERS

For Cable Group Legend, see page 69

### JACK-TO-JACK ADAPTER

| P.N.   | Cable Group | Finish | Insulation | Impedance | Crimp Tool |
|--------|-------------|--------|------------|-----------|------------|
| 112445 | N/A         | Nickel | Delrin     | 50        | N/A        |
| 112446 | N/A         | Nickel | Delrin     | 75        | N/A        |

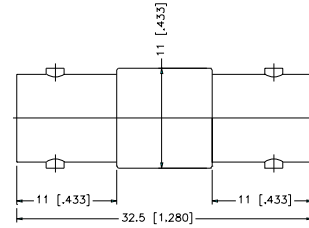

### PLUG-TO-PLUG ADAPTER

| P.N.          | Cable Group | Finish | Insulation | Impedance | Crimp Tool |
|---------------|-------------|--------|------------|-----------|------------|
| Brass Shell   |             |        |            |           |            |
| 112447        | N/A         | Nickel | Delrin     | 50        | N/A        |
| 112448        | N/A         | Nickel | Delrin     | 75        | N/A        |
| Diecast Shell |             |        |            |           |            |
| 112449        | N/A         | Nickel | Delrin     | 50        | N/A        |
| 112450        | N/A         | Nickel | Delrin     | 75        | N/A        |

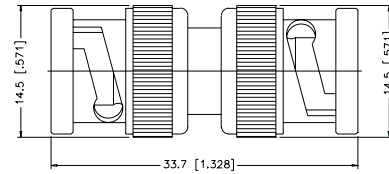

### RIGHT ANGLE ADAPTER — PLUG-TO-JACK

| P.N.          | Cable Group | Finish | Insulation | Impedance | Crimp Tool |
|---------------|-------------|--------|------------|-----------|------------|
| Brass Shell   |             |        |            |           |            |
| 112451        | N/A         | Nickel | Delrin     | 50        | N/A        |
| 112452        | N/A         | Nickel | Delrin     | 75        | N/A        |
| Diecast Shell |             |        |            |           |            |
| 112453        | N/A         | Nickel | Delrin     | 50        | N/A        |
| 112454        | N/A         | Nickel | Delrin     | 75        | N/A        |

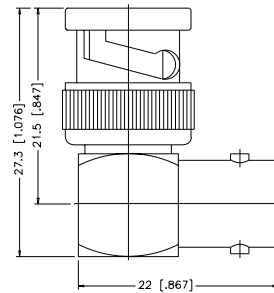

### RIGHT ANGLE ADAPTER — PLUG-TO-PLUG

| P.N.   | Cable Group | Finish | Insulation | Impedance | Crimp Tool |
|--------|-------------|--------|------------|-----------|------------|
| 112655 | N/A         | Nickel | Delrin     | 50        | N/A        |

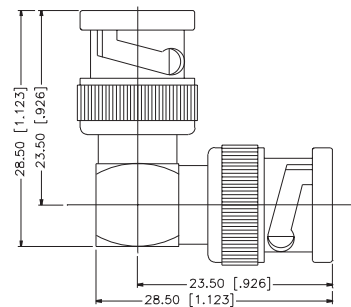

For Reverse Polarized connectors, add RP to standard part number. Contact Connex marketing for availability.  
For Crimp Tool information, see page 183.

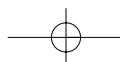

## TEE ADAPTERS

For Cable Group Legend, see page 69

### TEE ADAPTER — JACK-TO-JACK-TO-JACK

| P.N.   | Cable Group | Finish | Insulation | Impedance | Crimp Tool |
|--------|-------------|--------|------------|-----------|------------|
| 112455 | N/A         | Nickel | Delrin     | 50        | N/A        |
| 112456 | N/A         | Nickel | Delrin     | 75        | N/A        |

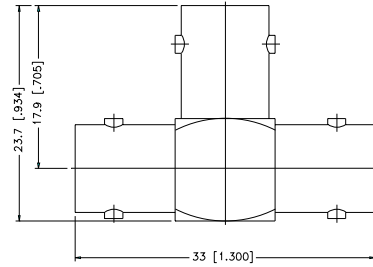

### TEE ADAPTER — JACK-TO-PLUG-TO-JACK

| P.N.   | Cable Group | Finish | Insulation | Impedance | Crimp Tool |
|--------|-------------|--------|------------|-----------|------------|
| 112461 | N/A         | Nickel | Delrin     | 50        | N/A        |
| 112462 | N/A         | Nickel | Delrin     | 75        | N/A        |

Remark: Diecast Version  
Remark: TEE contact pin isolated completely

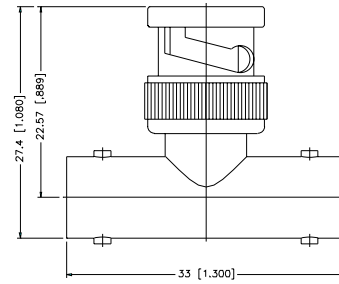

### TEE ADAPTER — JACK-TO-JACK-TO-PLUG

| P.N.   | Cable Group | Finish | Insulation | Impedance | Crimp Tool |
|--------|-------------|--------|------------|-----------|------------|
| 112567 | N/A         | Nickel | Delrin     | 50        | N/A        |
| 112590 | N/A         | Nickel | Teflon     | 50        | N/A        |

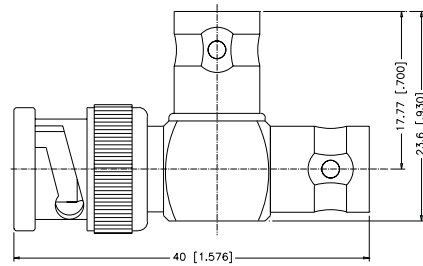

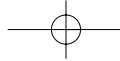

## TERMINATORS

For Cable Group Legend, see page 69

### BNC TERMINATOR PLUG

| P.N.             | Cable Group | Finish | Insulation | Impedance | Crimp Tool |
|------------------|-------------|--------|------------|-----------|------------|
| 202103           | N/A         | Nickel | Delrin     | 50        | N/A        |
| 202104           | N/A         | Nickel | Teflon     | 50        | N/A        |
| 202105           | N/A         | Nickel | Delrin     | 75        | N/A        |
| 202106           | N/A         | Nickel | Teflon     | 75        | N/A        |
| 202107           | N/A         | Nickel | Delrin     | 93        | N/A        |
| 202108           | N/A         | Nickel | Teflon     | 93        | N/A        |
| 202113           | N/A         | Nickel | Teflon     | 50        | N/A        |
| HIGH PERFORMANCE |             |        |            |           |            |
| 202119           | N/A         | Nickel | Teflon     | 75        | N/A        |
| HIGH PERFORMANCE |             |        |            |           |            |

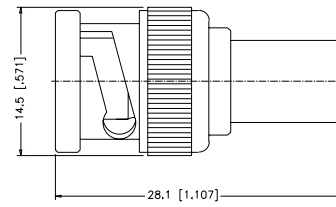

### BNC TERMINATOR JACK

| P.N.   | Cable Group | Finish | Insulation | Impedance | Crimp Tool |
|--------|-------------|--------|------------|-----------|------------|
| 202120 | N/A         | Nickel | Delrin     | 50        | N/A        |
| 202111 | N/A         | Nickel | Delrin     | 75        | N/A        |
| 112504 | N/A         | Nickel | Delrin     | 500       | N/A        |

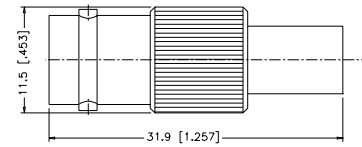

For Reverse Polarized connectors, add RP to standard part number. Contact Connex marketing for availability.  
For Crimp Tool information, see page 183.

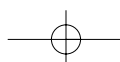

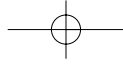

## ACCESSORIES

For Cable Group Legend, see page 69

### BNC MALE CAP & CHAIN

| P.N.                        | Cable Group | Finish | Insulation | Impedance | Crimp Tool |
|-----------------------------|-------------|--------|------------|-----------|------------|
| 202100                      | N/A         | Nickel | N/A        | N/A       | N/A        |
| Remark: Chain Length 100 mm |             |        |            |           |            |
| 202100-10                   | N/A         | Nickel | N/A        | N/A       | N/A        |
| LESS CHAIN                  |             |        |            |           |            |

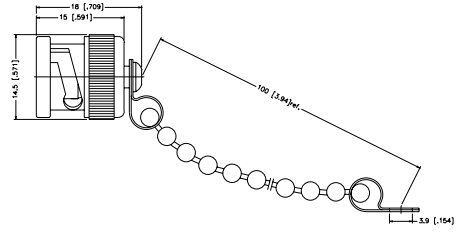
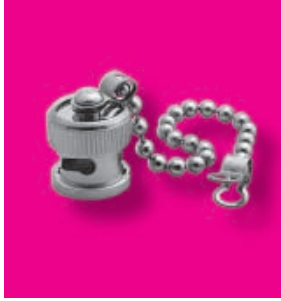

### BNC MALE SHORTING CAP

| P.N.       | Cable Group | Finish | Insulation | Impedance | Crimp Tool |
|------------|-------------|--------|------------|-----------|------------|
| 202114     | N/A         | Nickel | Teflon     | N/A       | N/A        |
| LESS CHAIN |             |        |            |           |            |
| 202115     | N/A         | Nickel | Teflon     | N/A       | N/A        |
| WITH CHAIN |             |        |            |           |            |

