

Introducing
Hermaphroditic Blade and
Receptacle Connector
Wire-to-Board, Board-to-Board and Dust Cover

 **Tyco Electronics**
Our commitment. Your advantage.

Hermaphroditic Blade and Receptacle Connector : Wire-to-Board

KEY FEATURES

- Available in 2, 4, and 6 positions
- Connector mates to new Hermaphroditic Blade and Receptacle Board-to-Board part numbers
- Positive Latching
- Connector accepts crimp snap contacts
- Contacts accept 18 – 22 AWG stranded wire
- Contacts packaged on 24 inch reels for high speed lead termination
- Housings are bulk packaged
- RoHS compliant

DESCRIPTIONS

The Wire-to-Board connector is a new plug connector that mates to the new part number series of the surface mount Hermaphroditic Blade and Receptacle board to board connectors. The connector provides power to the first LED printed circuit board in a string of rigid printed circuit board light strips.

APPLICATIONS

LED Lighting Controls

LED Lighting Strips

Channel Lettering

ELECTRICAL

Operating Current : 6 AMPS

Operating Voltage : 125VAC/125VDC

Dielectric Withstanding Voltage : 1500VAC

MECHANICAL

Operating Temperature : -40°C to +105°C

Mating cycles : 10

MATERIALS

Housings : UL 94 V-0

Contacts : Tin plated brass

STANDARDS AND SPECIFICATIONS

114-13252 : Wire-to-Board Application Specification

108-2387 : Wire-to-Board Product Specification

UL and cUL recognized : File No. E28476

APPLICATION TOOLING

2063778-1 : PRO-CRIMPER III Hand Tool (includes die set)

2063778-2 : Die Set for Hand Tool

1852817-1 : Leadmaker Applicator

1852817-2 : AMP-O-LECTRIC "K" Press Applicator

1852817-3 : AMP-O-LECTRIC "G" Press Applicator

For more information visit : <http://tooling.tycoelectronics.com>

Hermaphroditic Blade and Receptacle Connector : Board-to-Board

KEY FEATURES

- Available in 2, 4, and 6 positions
- Connector mates to itself
- Single part to be stocked and placed onto pcb per position
- Connector mates and unmates horizontally and vertically
- Connector can be articulated from 90° to 180°
- Tape and reel packed for high speed SMT processes
- Low profile flat surface is compatible with SMT and reflow processing
- Rounded corners to minimize shadowing
- Redundant SMT pads
- Solder pad footprint compatible with Tyco Electronics SMT Poke-In LED connector
- Optional 2, 4 and 6 position dust cover available
- RoHS compliant

DESCRIPTIONS

The hermaphroditic blade and receptacle connector is a new SMT connector and is intended for use with in-line board-to-board applications.

APPLICATIONS

LED Lighting Controls, LED Lighting Strips, Channel Lettering

ELECTRICAL

Operating Current : 6 AMPS

Operating Voltage : 125VAC/125VDC

Dielectric Withstanding Voltage : 1500VAC

MECHANICAL

Operating Temperature : -40°C to +105°C

MATERIALS

Housings : UL 94V-0 high temperature resistant thermoplastic

Contacts : Copper Alloy, tin over nickel plated

Dust Cover : PBT

STANDARDS AND SPECIFICATIONS

114-13225 : Board-to-Board Application Specification

108-2342 : Board-to-Board Design Objectives

UL and cUL Recognized : File No. E28476

PRODUCT OFFERING

Blade and Receptacle SMT Connectors

Part Number	POSITION	COLOR
2058703-1	2	White
2058703-2	4	White
2058703-3	6	White
1-2058703-1	2	Black
1-2058703-2	4	Black
1-2058703-3	6	Black

Dust Cover

Part Number	POSITION	COLOR
2058128-1	2	Natural
2058128-2	4	Natural
2058128-3	6	Natural
1-2058128-1	2	Black
1-2058128-2	4	Black
1-2058128-3	6	Black

Hermaphroditic Blade and Receptacle Connector Board-to-Board

PRODUCT DIMENSIONS

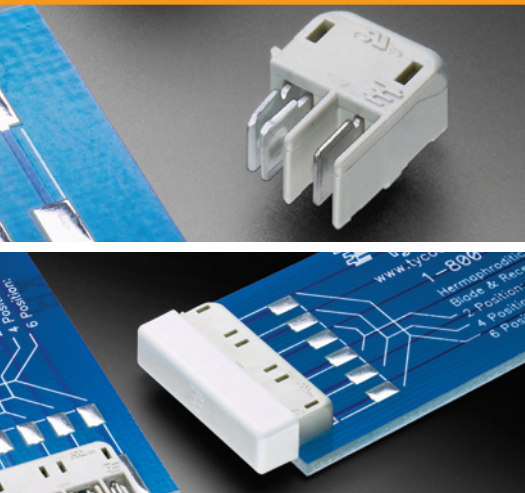

Board-to-Board

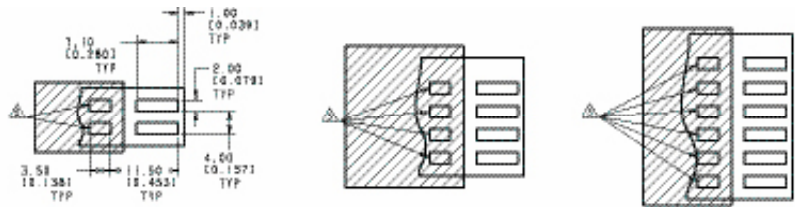

* Optional pads for SMT poke-in connector for P/N 1954097-1

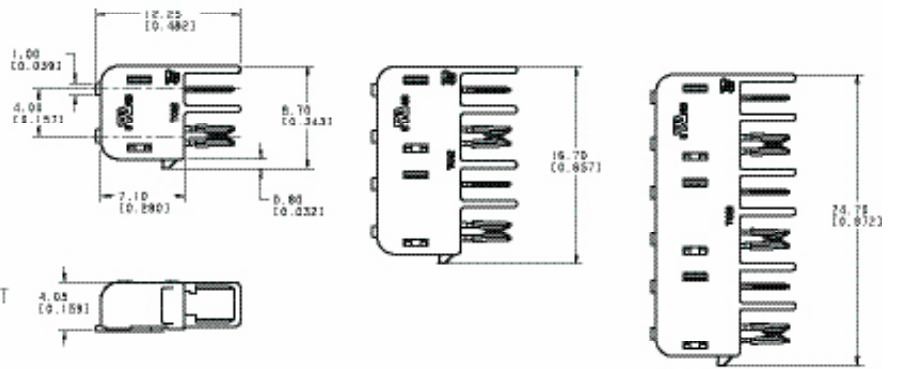

0.13 [0.005] MAX PERMISSIBLE MISALIGNMENT BETWEEN BOARD EDGE AND CONNECTOR FACE

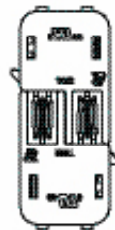
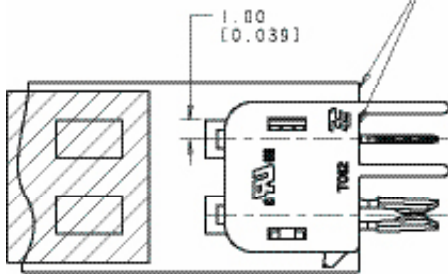

2058103-1/
1-2058103-1

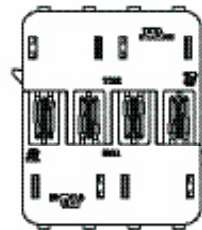

2058103-2/
1-2058103-2

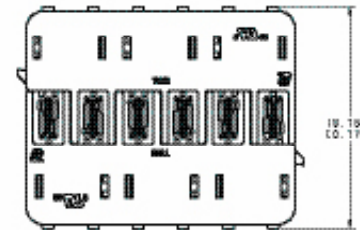

2058103-3/
1-2058103-3

R

Dust Cover

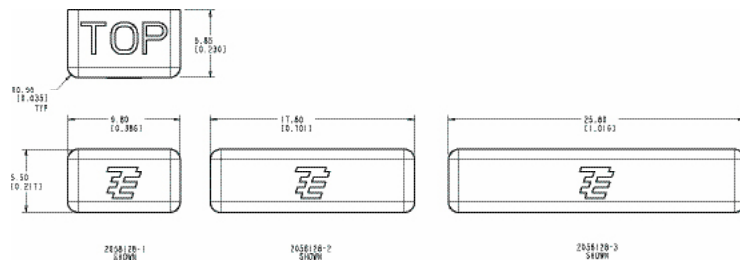

2058120-1
SHOW

2058120-2
SHOW

2058120-3
SHOW

Hermaphroditic Blade and Receptacle Connector Wire-to-Board

PRODUCT OFFERING AND DIMENSIONS

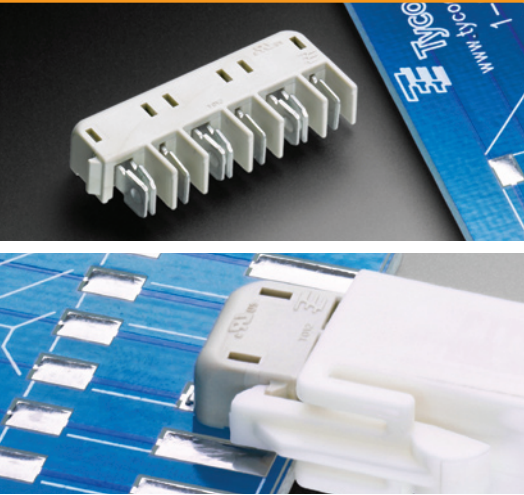

Wire-to-Board

Housings

Part Number	POSITION	COLOR
2058299-1	2	Natural
2058299-2	4	Natural
2058299-3	6	Natural
1-2058299-1	2	Black
1-2058299-2	4	Black
1-2058299-3	6	Black

Contacts

2058301-1	Blade Contact
2058301-2	Blade Contact - Loose Piece
2058302-1	Socket Contact
2058302-2	Socket Contact - Loose Piece

Cable Assemblies

Part Number	POSITION	COLOR
2058300-1	2	Natural
2058300-2	4	Natural
2058300-3	6	Natural
1-2058300-1	2	Black
1-2058300-2	4	Black
1-2058300-3	6	Black

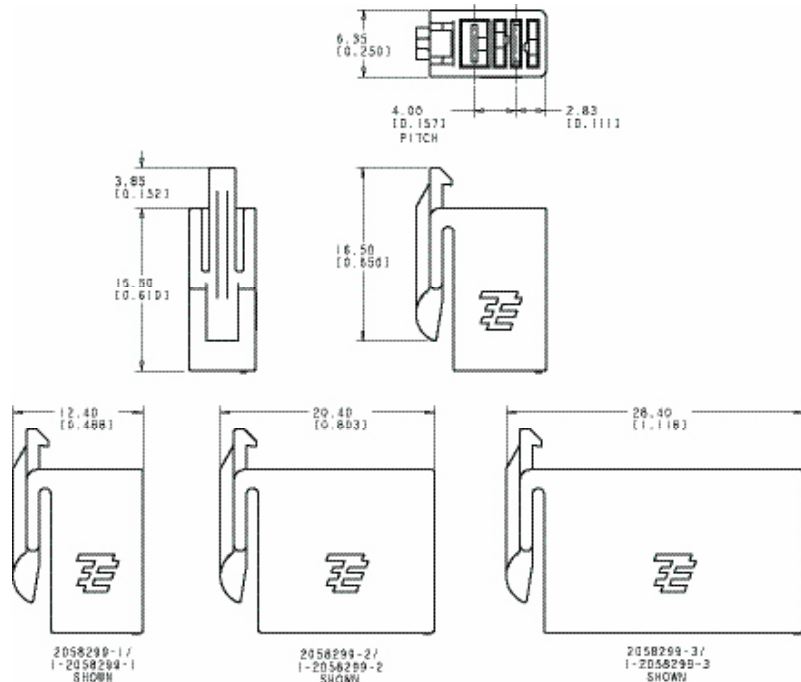

FOR MORE INFORMATION

www.tycoelectronics.com/lighting

Technical Support

Internet:	www.tycoelectronics.com/help
USA:	+1 (800) 522-6752
Canada:	+1 (905) 470-4425
Mexico & Central America:	+ 52(0) 55-1106-0814
South America:	+55 (0) 11-2103-6000
Germany:	+49 (0) 6251-133-1999
UK:	+44 (0) 8706-080208
France:	+33 (0) 1-3420-8686
Netherlands:	+31 (0) 73-6246-999
China:	+86 (0) 400-820-6015

Tyco Electronics Corporation

Harrisburg, PA

tycoelectronics.com

© 2009 Tyco Electronics Corporation All Rights Reserved.

6-1773454-3 2.5M F/P 11/2009

AMP-O-ELECTRIC, TE (logo) and Tyco Electronics are trademarks of the Tyco Electronics group of companies and its licensors.

Other products, logos, and Company names mentioned herein may be trademarks of their respective owners.

While Tyco Electronics has made every reasonable effort to ensure the accuracy of the information in this catalog, Tyco Electronics does not guarantee that it is error-free, nor does Tyco Electronics make any other representation, warranty or guarantee that the information is accurate, correct, reliable or current. Tyco Electronics reserves the right to make any adjustments to the information contained herein at any time without notice. Tyco Electronics expressly disclaims all implied warranties regarding the information contained herein, including, but not limited to, any implied warranties of merchantability or fitness for a particular purpose. The dimensions in this catalog are for reference purposes only and are subject to change without notice. Specifications are subject to change without notice. Consult Tyco Electronics for the latest dimensions and design specifications.

