

# 3M™ Four-Wall Header

.100" × .100" Latch/Ejector, Straight and Right Angle

3000 Series

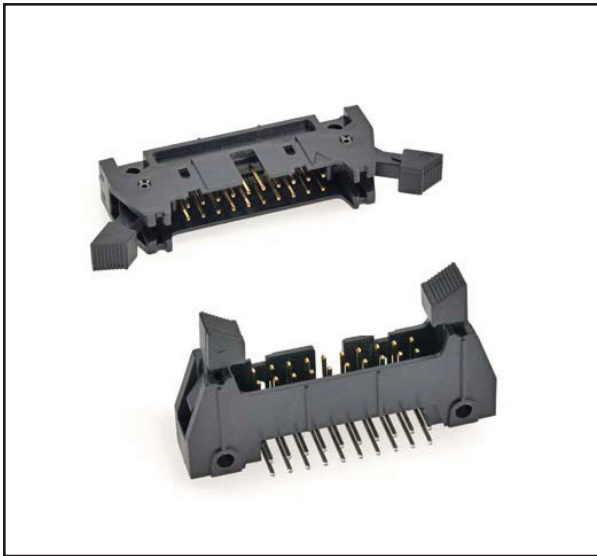

- Military (with 3M's 3518 & N3518 polarizing key) and centerbump polarization
- Optional ejector latches
- Mounting holes for securing header to board
- Optional polarizing posts available
- High temperature insulator option suitable for "no lead" soldering operations
- High temperature option suitable for reflow soldering using "paste in hole" techniques
- Solder tail option
- See the Regulatory Information Appendix (RIA) in the "RoHS compliance" section of [www.3Mconnector.com](http://www.3Mconnector.com) for compliance information

Date Modified: December 3, 2010

TS-0772-L  
Sheet 1 of 4

## Physical

### Insulator:

Material: Glass Filled Polyester (PBT) Glass Filled Polyester (PCT) - (High Temp Option)

Flammability: UL 94V-0

Color: Gray (PBT), Black (PCT)

### Contact:

Material: Copper Alloy

### Plating:

Underplating: 100 μ" [2.54 μm] Nickel- Overall

Wiping Area: 30 μ" [0.76 μm] Gold

Solder Tails: Tin Lead or Matte Tin (See Ordering Information)

**Marking:** 3M Logo, Part Identification Number and Orientation Triangle

## Electrical

**Current Rating:** 2 A (EIA 364-70)

**Insulation Resistance:**  $>1 \times 10^9 \Omega$  at 500 V<sub>DC</sub>

**Withstanding Voltage:** 1,000 V<sub>RMS</sub> at Sea Level

## Environmental

**Temperature Rating:** -55°C to +105°C

**Process Rating:** 260°C - (High Temp PCT insulator version), single pass, (profile per J-STD-020C) (PBT insulator version), maximum insulator temperature 191°C (solder wave process only)

**Moisture Sensitivity Level:** 1 (per J-STD-020C) High Temp. (PCT) versions only

UL File No.: E68080

**3M**  
Electronic Solutions Division  
Interconnect Solutions  
<http://www.3Mconnector.com>

3M is a trademark of 3M Company.  
For technical, sales or ordering information call  
**800-225-5373**



# 3M™ Four-Wall Header

.100" × .100" Latch/Ejector, Straight and Right Angle

3000 Series

Pin Qty	3M Part Number	Dimensions				Polarizing Notches
		A	B	C	D	
06	3869	1.065 (27.05)	0.905 (22.99)	0.665 (16.89)	0.505 (12.83)	B*
08	3889	1.165 (29.59)	1.005 (25.53)	0.765 (19.43)	0.605 (15.37)	B*
10	3793	1.265 (32.13)	1.105 (28.04)	0.865 (21.97)	0.705 (17.91)	BC
14	3314	1.465 (37.21)	1.305 (33.12)	1.065 (27.05)	0.905 (22.99)	BC
16	3408	1.565 (39.75)	1.405 (35.66)	1.165 (29.59)	1.005 (25.53)	ABC
20	3428	1.765 (44.83)	1.605 (40.74)	1.365 (34.67)	1.205 (30.61)	ABC
24	3627	1.965 (49.91)	1.805 (45.82)	1.565 (39.75)	1.405 (35.69)	ABC
26	3429	2.065 (52.45)	1.905 (48.36)	1.665 (42.29)	1.505 (38.23)	ABC
30	3440	2.265 (57.53)	2.105 (53.44)	1.865 (47.37)	1.705 (43.31)	ABC
34	3431	2.465 (62.61)	2.305 (58.52)	2.065 (52.45)	1.905 (48.39)	ABC
40	3432	2.765 (70.23)	2.605 (66.14)	2.365 (60.07)	2.205 (56.01)	ABC
50	3433	3.265 (82.93)	3.105 (78.84)	2.865 (72.77)	2.705 (68.71)	ABC
60	3372	3.765 (95.63)	3.605 (91.54)	3.365 (85.47)	3.205 (81.41)	ABC
64	3764	3.965 (100.71)	3.805 (96.62)	3.565 (90.55)	3.405 (86.49)	ABC

Inch (mm)			
Tolerance Unless Noted			
	.0	.00	.000
Inch	± .1	± .01	± .005

[ ] Dimensions for Reference only

\* Available without center notch B. Contact 3M.

3M Part Number Suffix	Contact Tail	Dim E	Pin Cross Section			Dim G
-5XX2	Solder Tail for .062 (1.57) Thick PC Board	.112 ± .010 (2.84)	Dim F	Diagonals	Corner Radii	0.035 ± .003 (0.89) (See Note 3)
-6XX2			.0245 ± .0005 (0.622)	.028 ± .001 (0.71)	.0075 Ref (0.191)	
-5X03	Solder Tail for 0.94 (2.39) to .125 (3.18) Thick PC Board	.155 ± .010 (3.94)	.0245 ± .0005 (0.622)	.028 ± .001 (0.71)	.0075 Ref (0.191)	0.035 ± .003 (0.89)
-6X03						

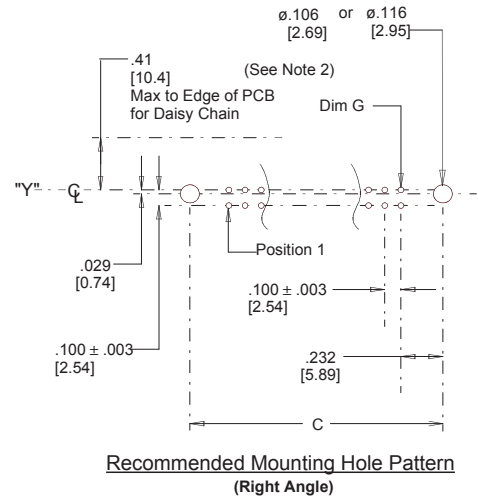
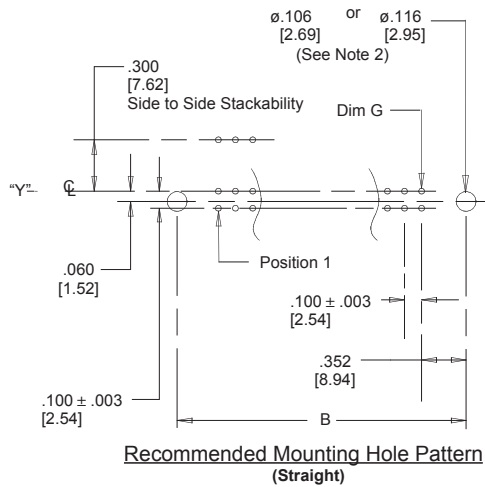

- Notes: 1. Notches A & C will accommodate 3M Polarizing Keys (3M Part #3518 or #N3518).  
 2. Mounting hardware: From solder side of pc board use #4-24 thread cutting screw (3M Part # 3341-5) and .116 [2.95] dia mounting hole. For right angle version only, #2-56 bolt and nut (3M Part # 3341-6) with .106 [2.69] dia mounting hole may be used.  
 3. The recommended PCB hole size for the kinked tail positions on the .112 solder tail connector is .035 ± .002. See page 4 for kink position details (K2 version).  
 4. Contact your 3M sales representative for custom requirements.

## Ordering Information

N = High Temp Black (PCT)/(RB Plating Req'd)  
 Blank = Std. Temp Gray (PBT)/(Blank or UB Pltg. Req'd.)

**X3XXX-XXXXXX**

3M Part Number  
(See Table 1)

Pin Configuration  
 5 = Right Angle Solder Tails  
 6 = Straight Solder Tails

Latch/Ejector System  
 0 = No Latch/Ejector installed  
 2 = Short Roll Pin Latch/Ejectors  
 3 = Long Roll Pin Latch/Ejectors  
 5 = Short, Snap-In Latch/Ejectors  
 6 = Long, Snap-In Latch/Ejectors

Plating  
 RB = 30 μ" [ 0.76 μm ] Gold and 200 μ" [ 5.08 μm ] Matte Tin  
 (App. E1 & C1 Apply)  
 Blank or UB = 30 μ" (0.76 μm) Gold and 200 μ" [ 5.08 μm ]  
 Tin Lead (App. E3 & C2 Apply)

Tail  
 02 = for .062 [1.57] thick board  
 03 = for .094 to .125 [2.39 to 3.18] thick board  
 K2 = kinked for .062 [1.57] thick board

TS-0772-L  
 Sheet 3 of 4

# 3M™ Four-Wall Header

.100" × .100" Latch/Ejector, Straight and Right Angle

3000 Series

## Part Customization

This spec sheet details our standard offering.

3M has several capabilities that can provide a part tailored to your specific needs. Ask your 3M sales representative or customer service for more details.

Both snap in and roll pin latches may be ordered separately. Snap in and roll style latches are dimensionally and functionally equivalent. If ordering snap-in or roll pin style latches separately, please use the below chart.

	Short Latch	Long Latch	Latch Style	Color
Standard Temperature (PBT)	3505-2	3505-3	Roll Pin	Gray
High Temperature (PCT)	N3505-2B	N3505-3B	Roll Pin	Black
High Temperature (PBT)	3505-30	3505-31	Snap-In	Gray
High Temperature (PPA)	N3505-30B	N3505-31B	Snap-In	Black

- Selective pin removal (ATA or other compatability)
- Wire wrap tails styles

## Polarizing Post

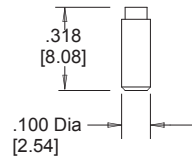

3201-4	LCP	Black
3201-5	PBT	Gray

Note: Insert Post into one mounting hardware hole on bottom of header. Set post to protrude .115" [2.92].

## 2500 & 3000 Series Shrouded Header

Total Number of Pins	Number of Tails Kinked	Positions Kinked			
		3	4	7	8
10	4	3	4	7	8
14	4	3	4	11	12
16	4	3	4	13	14
20	4	3	4	17	18
24	4	3	4	21	22
26	4	3	4	23	24
30	4	5	6	25	26
34	4	7	8	27	28
36	4	7	8	27	28
40	4	7	8	33	34
50	4	7	8	43	44
60	4	11	12	49	50
64	4	11	12	53	54

Kinked Tail Detail:

Kink is located .05" below bottom surface of plastic.

External radius of kink toward part centerline.

## Mounting Hardware

3341-5  
(Installed from bottom of board)

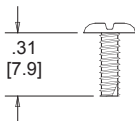

Panhead Thread Cutting Screw:  
#4-24 X 5/16"  
Type: USA Std BT, Federal BG

3341-6  
(Must be inserted prior to latch on vertical headers)

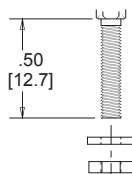

Hex Head Bolt, Nut and Washer  
Bolt - #2-56 X 1/2"

3341-5 & 6  
Material - Stainless Steel

## Polarizing Keys

			Dim A
N3518	LCP	Black	.02
3518	PBT	Gray	.02

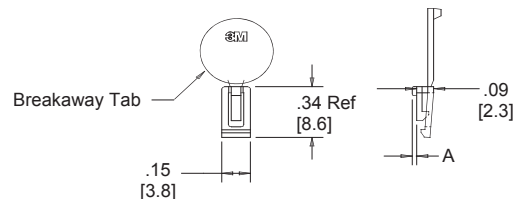

Note: #2216 B/A Scotchweld can be used to adhere keys.

TS-0772-L  
Sheet 4 of 4

3M

Electronic Solutions Division  
Interconnect Solutions  
<http://www.3Mconnector.com>

3M is a trademark of 3M Company.  
For technical, sales or ordering information call  
**800-225-5373**

### **Important Notice**

All statements, technical information, and recommendations related to 3M's products are based on information believed to be reliable, but the accuracy or completeness is not guaranteed. Before using this product, you must evaluate it and determine if it is suitable for your intended application. You assume all risks and liability associated with such use. Any statements related to the product which are not contained in 3M's current publications, or any contrary statements contained on your purchase order shall have no force or effect unless expressly agreed upon, in writing, by an authorized officer of 3M.

### **Warranty; Limited Remedy; Limited Liability.**

This product will be free from defects in material and manufacture for a period of ninety (90) days from the time of purchase. **3M MAKES NO OTHER WARRANTIES INCLUDING, BUT NOT LIMITED TO, ANY IMPLIED WARRANTY OF MERCHANTABILITY OR FITNESS FOR A PARTICULAR PURPOSE.** If this product is defective within the warranty period stated above, your exclusive remedy shall be, at 3M's option, to replace or repair the 3M product or refund the purchase price of the 3M product. **Except where prohibited by law, 3M will not be liable for any indirect, special, incidental or consequential loss or damage arising from this 3M product, regardless of the legal theory asserted.**



### **3M Electronics Solutions Division**

6801 River Place Blvd.  
Austin, TX 78726-9000  
U.S.A.  
1-800-225-5373  
[www.3Mconnector.com](http://www.3Mconnector.com)

Please recycle. Printed in USA.  
© 3M 2010. All rights reserved.  
RIA-2217B-E

3M is a trademark of 3M Company.