

Wire-to-Board, .100 [2.54] Centerline Products

Wire Sizes

Wire Size		Product Family
AWG	[mm ²]	
20	0.5-0.6	Locking Clip, Mod. IV, IV.v, V, MT, Short Point
22-30	0.3-0.05	Locking Clip, Mod. IV, IV.v, V, MTE, MT, Short Point
32	0.03	Mod. IV, IV.v, V, Short Point

Contact Platings

Platings	Product Family
.000015 [0.00038] Gold	Mod. IV, IV.v, V, MTE, MT, Short Point
.000030 [0.00076] Gold	Locking Clip, Mod. IV, IV.v, V, MTE, MT, Short Point
.000050 [0.00127] Gold	Locking Clip, Mod. IV, IV.v, V, MT
Tin	Locking Clip, Mod. IV, IV.v, V, MTE, MT, Short Point

Mating Post Lengths

Post Lengths	Product Family
.210-.283 [5.33-7.19]	Mod. IV (.600 [15.24] Profile Height)
.205-.283 [5.21-7.19]	Mod. IV.v (.600 [15.24] Profile Height)
.185-.283 [4.70-7.19]	Mod. V (.600 [15.24] Profile Height)
.256-.323 [6.50-8.20]	Mod. IV (.645 [16.38] Profile Height)
.251-.323 [6.38-8.20]	Mod. IV.v (.645 [16.38] Profile Height)
.231-.323 [5.87-8.20]	Mod. V (.645 [16.38] Profile Height)
.222-.273 [5.64-6.93]	MT Assembly with Standard Pressure Contacts
.200-.273 [5.08-6.93]	MT Assembly with High Pressure Contacts
.200-.250 [5.08-6.35]	MTE Assembly
.169-.259 [4.29-6.58]	Short Point Connector Assembly
.273-.350 [6.93-8.89]	Locking Clip (Connector Assembly)
.200-.277 [5.08-7.04]	Locking Clip (Single Contact)

Application Tooling

Application Tooling Description	Product Family					
	Mod. IV, IV.v, V	MT	Locking Clip	MTE	Short Point	Level V
Manual Hand Tools (Wire Crimp)	•		•	•	•	
Manual Hand Tools (IDC)		•		•		•
AMP-O-MATIC Stripper/Crimper Machines with Applicator	•		•		•	
CHAMPOMATOR Model 2.5 Machine		•				•
CHAMPOMATOR Model 3A Machine		•				
AMP-O-LECTRIC Machines with Applicator	•		•		•	
Pneumatic Hand Tools	•	•	•	•	•	•
IDC Electric Power Unit				•		
Tube-Fed Ribbon Cable Machine				•		
AMPOMATOR CLS Machines	•		•		•	
Discrete Wire Machine		•				•
Manual Arbor Tool		•				•
Pneumatic Arbor Tool		•				•

Board-to-Board Solutions Guide, .100 [2.54] Centerline Products

Problem or Concern	Tyco Electronics' Potential Solution	Single-Row Vertical Headers and Receptacles (Page Ref.)	Single-Row Right-Angle Headers, Horizontal Receptacles (Page Ref.)	Double-Row Vertical Headers and Receptacles (Page Ref.)	Double-Row Right-Angle Headers, Horizontal Receptacles (Page Ref.)	
Headers Float Off Board Soldering Operation	HEADERS Retention Feature: Unshrouded Shrouded	102 —	103 —	198 104, 199	199 105, 200	
Header Contacts Damaged During Manufacturing Operation or In-Field Use	Shrouded HEADERS : Standard Profile	115	116	117-121	122-128	
Board/Backplane Requires High Temperature Surface-Mount Compatibility	Press-Fit ACTION PIN POST					
	HEADERS : Unshrouded Shrouded	146 —	— —	147 148, 149, 199	— —	
	Machine Applied Posts	163, 164				
	Surface-Mount Compatible Thru-Hole: HEADERS : Unshrouded Shrouded (Low Profile) RECEPTACLES	102* — — —	103* — — —	104* 130*, 137* — 196*	105* 138* — 195*	
Application Requires Board Guidance, Polarization and/or Blind-Mate Capability	Surface-Mount: HEADERS RECEPTACLES	109* 187, 188	— 172	110 189-192	— 173	
	Two-Piece Family: w/Guide Posts: HEADERS RECEPTACLES	— —	— —	198, 199 196*	200 195*	
Reduction in Parallel Board-to-Board Stack Height Necessary (Refer to Parallel Stack Guide on Page 62.)	Mod IV Low Profile RECEPTACLES : TOP ENTRY : Thru-Hole Surface-Mount BOTTOM ENTRY : Thru-Hole Surface-Mount DUAL ENTRY : Thru-Hole Surface Mount	178 — — 177 — 181 187, 188	— — — — — — —	179, 180* — — — — 182-184 189-192	— — — — — — —	
	Soldering Problems with Thru-Hole Bottom Entry Receptacles (Must Mask Post Holes in Board During Soldering Operation)	RECEPTACLES : Bottom Entry Outrigger (Separate Holes for Receptacle Leads and Mating Leads)	181	—	182	—
	Application Requires Connectors to be End-to-End Stackable on .100 [2.54] Grid	End-to-End Stackable: HEADERS (Unshrouded): Thru-Hole Thru-Hole* Surface-Mount RECEPTACLES : Thru-Hole Surface Mount	93, 102 102* 109* 175, 177, 178, 181 188	94, 95, 103* 103* — 169* 172	96, 97, 104* 104* 110* 176, 179, 180*, 182*, 183, 184 191, 192	98, 99, 105 108* — 170 173

*High temperature compatible version, refer to page ref. listed.

Wire-to-Board Solutions Guide, .100 [2.54] Centerline Products

Customer Requirement	Tyco Electronics' Potential Solution	Catalog Page(s)
Application Requires Guidance, Polarization	Mod IV Polarized Housing	220
	MTE Latched Receptacle and Header	230, 231, 244-250
	MT with Polarizing Covers	256-258
Wire-to-Wire Application	Short Point Polarized Housing	224
	Mod IV Receptacle Contacts and Pins	211-213
Wire-to-Wire Application (Latched)	MTE Latched Receptacle and Shrouded Pin Assembly	230, 231, 236, 237
Wire-to-Wire Application (Through Panel)	MTE Panel Mount	242
High Vibration and Shock Applications	Locking Clip Contacts and Housings	207-209
Printed Circuit Board Polarization	MTE Header with PC Board Orientation Peg	248, 249
Board Requires Surface Mount Capability	MTE Surface Mount Headers	251, 252
	MTE High Temperature Compatible Headers	249, 250
Need to mate to AMP-LATCH Eject Headers	Mod IV Ejection Housing	220
Need to Minimize Strain to Cable	MT with Eject Covers	256-259
	Mod IV Housing with Strain Relief	218, 219
Application Requires Self-Retaining Contacts	Locking Clip Contacts	207, 298
Header Secured to Board During/Prior to Soldering	MTE Headers with Post Retention or Holddowns	244-250
Mate to Unshrouded Header with Retention Requirements	Mod IV plain Housing with Mod V Contacts	213, 214, 216
	MTE with High Pressure Contacts	234, 235
Multiple Cables to be Common to One Header	MTE Coupling Shroud, Double- or Single-Row	240, 241
Right-Angle Cable Dress	MT with Hermaphroditic Covers	229, 256, 257, 259
Application Requires Crimp Contacts and MTE Housings	Short Point Contacts	222
Housings and End-to-End and Side-to-Side Stackable	Short Point Double-Row Housing, MTE Plain Housing	223, 228, 229
Connector Must Mate to Post Lengths of .169 [4.29] Min.	Short Point Contacts	222

MTE Interconnection System

Product Facts

- Receptacle assemblies mate with .025 [0.64] sq. posts; mating post length is .200 [5.08] min., .250 [6.35] max.
- Proven AMPMODU receptacle contact design; dual cantilever beams, built-in anti-overstress, completely enclosed "box" design, standard or high-pressure
- Insulation displacement technology
- Two contact sizes for terminating 30-22 AWG [0.05-0.3 mm²] wire range; .054 [1.37] max. insulation diameter with an insulation wall thickness of .015 [0.38] max.
- Choice of gold duplex or tin plated contacts
- Interchangeable crimp snap-in pin and receptacle contacts available
- Housing sizes 2 through 25 positions, single-row .100 [2.54] centers
- Plain housings are end-to-end and/or back-to-back stackable for open pin field applications
- Optional header with "swaged tail" feature helps prevent movement prior to flow soldering
- Integral latch provides positive retention between header and receptacle housing
- Coupling shrouds permit ganging of smaller connectors with guide ribs to form larger single- or double-row latching connectors
- Mass terminating tooling provides lowest applied cost for most production needs
- SMT and SMT compatible, high-temp headers available
- Recognized under the Component Program of Underwriters Laboratories Inc., File No. E28476
- Certified by Canadian Standards Association, File No. LR7189

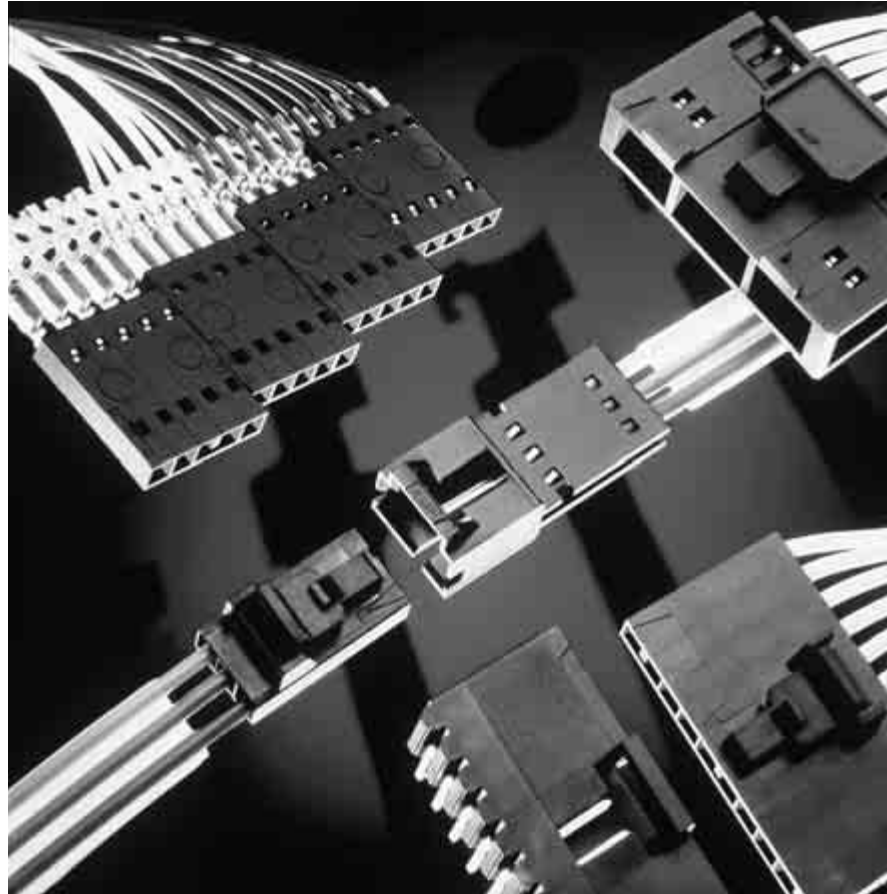

The AMPMODU MTE Interconnection System offers both wire-to-board and wire-to-wire connectors using .025 [0.64] sq. post technology.

The AMPMODU MTE Interconnection System consists of single-row housings with contacts preloaded on .100 [2.54] centers. Housings are furnished with contacts partially inserted, leaving the termination areas exposed. Final contact insertion can be accomplished automatically with Tyco Electronics application equipment, and manually when terminated with the Tyco Electronics pistol grip hand tool.

The heart of the system is the insulation displacement contact design, featured in both pin and receptacle contacts. The receptacle

contact, available in either standard or high-pressure, features dual cantilever beams in an enclosed "box." The post stop helps prevent a mating post from disturbing the wire termination and also limits the mating depth of a long post to protect a wrap-type termination at the base of the post. The forward contact stop helps prevent contact overinsertion prior to termination. All contacts are furnished on carrier strips which are interlocked for stability and positive location during termination.

Single-row housings are available in sizes 2 through 25 positions. Included are three styles of receptacle housings—plain, polarized/latching and ribbed and two styles of pin housings, shrouded with polarizing/latching feature and ribbed.

Performance Specifications

Electrical Characteristics

- Contact Current Rating** — 3 amperes for single contact in free air (Amperage could vary due to ambient temperature, wire size and duty cycles.)
- Contact Termination Resistance** — 15 milliohms (max.)
- Dielectric Withstanding Voltage** — At Sea Level—600 VAC, rms
At 70,000 Ft. [21 336 m]—225 VAC, rms
- Insulation Resistance** — 5,000 megohms (min.)

Environmental Characteristics

- Operating Temperature** — -65°C to +105°C
- Vibration** — 15 G's (gold), 10 G's (tin)
- Physical Shock** — 50 G's
- Industrial Mixed Flow Gasing** — Class 1 (20 days) (gold)
- Product Specification** 108-25034
- Application Specification** 114-25026

MTE Interconnection System (Continued)

Wire-to-Board

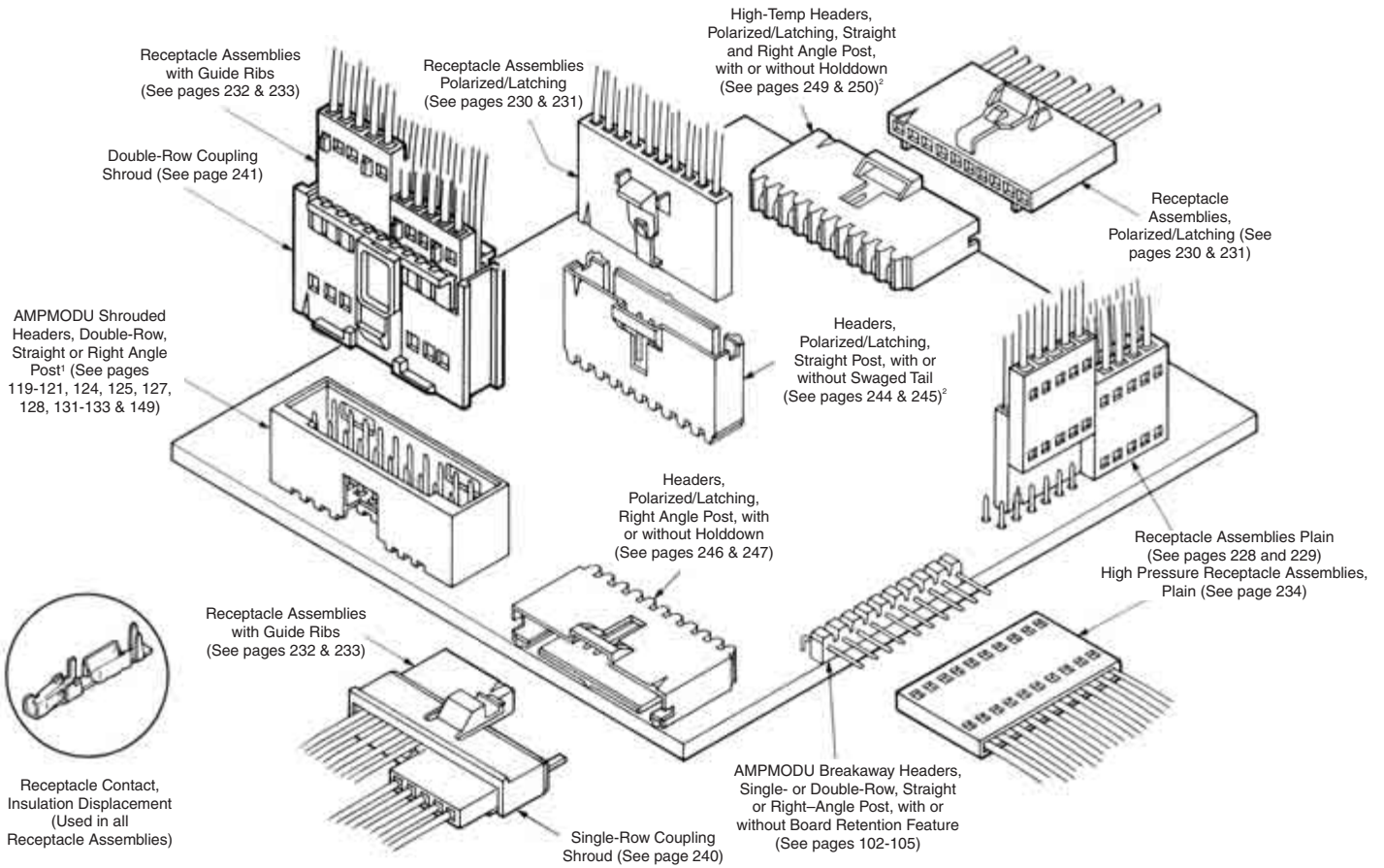

¹Mating AMPMODU Double-Row Shrouded Header Assemblies must have .318 [8.08] mating post length and .150 [3.81] dimension from centerline of last post to inside of end shroud wall.

²Surface Mount Right-Angle and Vertical Headers are also available (see pages 251 and 252)

MTE Interconnection System

5

MTE Interconnection System (Continued)

Wire-to-Wire

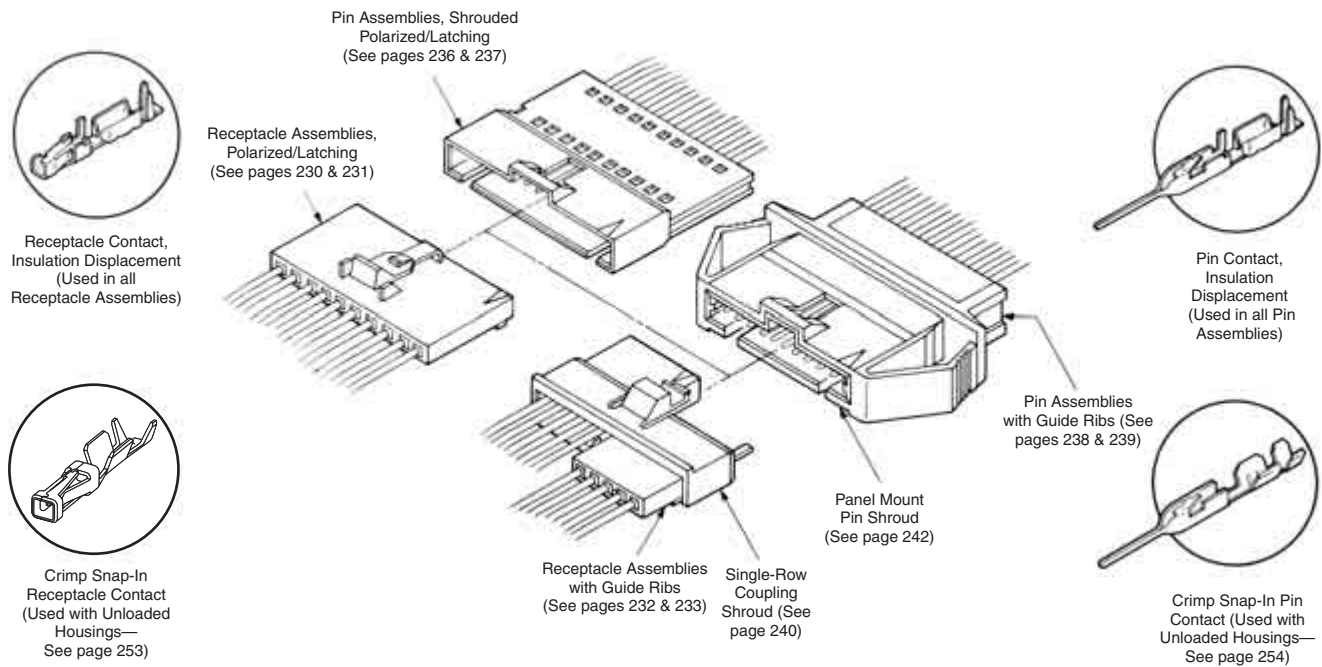

Note: For wire-to-wire applications shown above, all pin and receptacle assembly combinations are intermateable.

MTE Receptacle Assemblies—Plain, Single-Row, .100 [2.54] Centerline



Preassembled housings in strip form are available in positions 2 thru 12. For ease of handling, positions 2 thru 5 are recommended when using the Tyco Electronics Manual Pistol Grip Tool.

Material and Finish

Housing — Black thermoplastic, 94V-0 rated

Contacts — Phosphor Bronze, plated as follows:

Plating A — Duplex plated .000030 [0.00076] gold on contact area, .000050 [0.00127] min. tin in crimp area, with entire contact underplated .000050 [0.00127] nickel

Plating B — Duplex plated .000015 [0.00038] gold on contact area, .000050 [0.00127] min. tin in crimp area, with entire contact underplated .000050 [0.00127] nickel

Plating C — .000100 [0.00254] tin over .000050 [0.00127] nickel on entire contact

Note: Insulation displacement contacts accept an insulation diameter of .030 [0.76] min. to .054 [1.37] max. with an insulation wall thickness of .015 [0.38] max. Mating post length for preloaded housings is .200 [5.08] min., .250 [6.35] max.

Related Product Data

Mateable AMPMODU Products Breakaway Headers — pages 102-110 (with .230 mating length)

Reeled Breakaway Headers — pages 106, 107 (with .230 mating length)

Machine Applied Bandolier Posts — page 163

Single-Row Shrouded Headers with .066 [1.68] End Dimension — pages 115, 116

Interchangeable Crimp Contacts (Short Point) — page 253

Application Tooling — page 273

Performance Specifications — page 225

Technical Documents — pages 277, 278

Product Specification
108-25034

Application Specification
114-25026

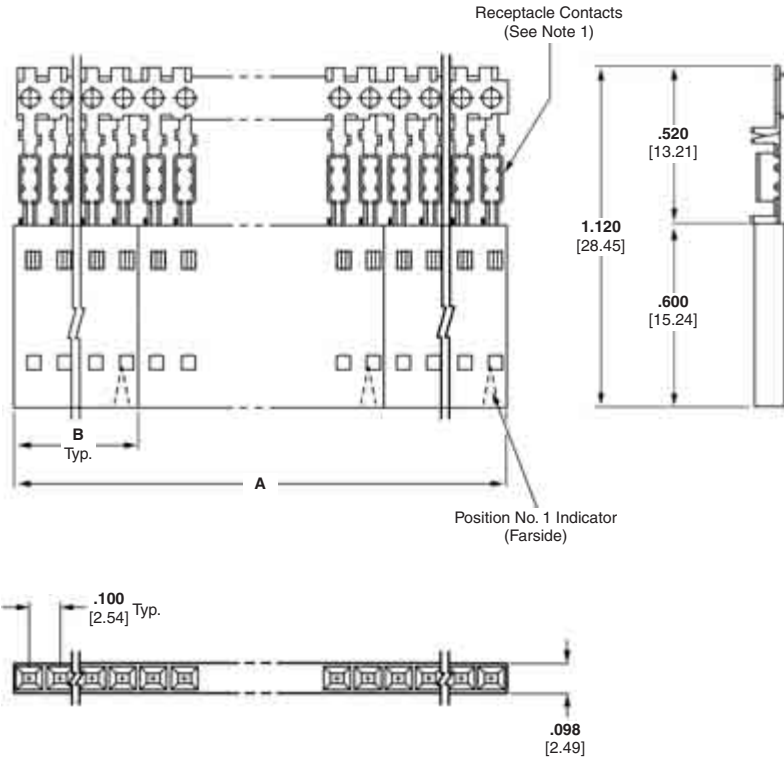

These receptacle assemblies with plain housings can be stacked end-to-end and/or side-to-side for single or double-row connections to an open pin field with a .100 [2.54] centerline grid.

MTE Receptacle Assemblies—Strip Form Plain, Single-Row, .100 [2.54] Centerline (Continued)

No. of Pos.	Dimensions		Housing Quantities Per Strip Segment	Strip Form Receptacle Assembly 30-26 AWG [0.05-0.15mm ²] Wire			Strip Form Receptacle Assembly 26-22 AWG [0.12-0.3mm ²] Wire			Unloaded Housings
	A	B		Plating A	Plating B	Plating C	Plating A	Plating B	Plating C	
2	2.000 [50.80]	.198 [5.03]	10	5-103979-1	5-103978-1	5-103977-1	5-103976-1	5-103975-1	5-103974-1	103688-1
3	2.400 [60.96]	.298 [7.57]	8	5-103979-2	5-103978-2	5-103977-2	5-103976-2	5-103975-2	5-103974-2	103688-2
4	1.990 [50.55]	.398 [10.11]	5	5-103979-3	5-103978-3	5-103977-3	5-103976-3	5-103975-3	5-103974-3	103688-3
5	1.990 [50.55]	.498 [12.65]	4	5-103979-4	5-103978-4	5-103977-4	5-103976-4	5-103975-4	5-103974-4	103688-4
6	2.390 [60.71]	.598 [15.19]	4	5-103979-5	5-103978-5	5-103977-5	5-103976-5	5-103975-5	5-103974-5	103688-5
7	1.400 [35.56]	.698 [17.73]	2	5-103979-6	5-103978-6	5-103977-6	5-103976-6	5-103975-6	5-103974-6	103688-6
8	1.600 [40.64]	.798 [20.27]	2	5-103979-7	5-103978-7	5-103977-7	5-103976-7	5-103975-7	5-103974-7	103688-7
9	1.800 [45.72]	.898 [22.81]	2	5-103979-8	5-103978-8	5-103977-8	5-103976-8	5-103975-8	5-103974-8	103688-8
10	2.000 [50.80]	.998 [23.35]	2	5-103979-9	5-103978-9	5-103977-9	5-103976-9	5-103975-9	5-103974-9	103688-9
11	2.200 [55.88]	1.098 [27.89]	2	6-103979-0	6-103978-0	6-103977-0	6-103976-0	6-103975-0	6-103974-0	1-103688-0
12	2.400 [60.96]	1.198 [30.43]	2	6-103979-1	6-103978-1	6-103977-1	6-103976-1	6-103975-1	6-103974-1	1-103688-1

MTE Receptacle Assemblies—Individual Form Plain, Single-Row, .100 [2.54] Centerline

No. of Pos.	Dimensions B	Individual Receptacle Assembly 30-26 AWG [0.05-0.15mm ²] Wire			Individual Receptacle Assembly 26-22 AWG [0.12-0.3mm ²] Wire			Unloaded Housings
		Plating A	Plating B	Plating C	Plating A	Plating B	Plating C	
13	1.298 [32.96]	6-103903-2	6-103684-2	6-103685-2	6-103902-2	6-103686-2	6-103687-2	1-103688-2
14	1.398 [35.51]	6-103903-3	6-103684-3	6-103685-3	6-103902-3	6-103686-3	6-103687-3	1-103688-3
15	1.498 [38.05]	6-103903-4	6-103684-4	6-103685-4	6-103902-4	6-103686-4	6-103687-4	1-103688-4
16	1.598 [40.59]	6-103903-5	6-103684-5	6-103685-5	6-103902-5	6-103686-5	6-103687-5	1-103688-5
17	1.698 [43.13]	6-103903-6	6-103684-6	6-103685-6	6-103902-6	6-103686-6	6-103687-6	1-103688-6
18	1.798 [45.67]	6-103903-7	6-103684-7	6-103685-7	6-103902-7	6-103686-7	6-103687-7	1-103688-7
19	1.898 [48.20]	6-103903-8	6-103684-8	6-103685-8	6-103902-8	6-103686-8	6-103687-8	1-103688-8
20	1.998 [50.75]	6-103903-9	6-103684-9	6-103685-9	6-103902-9	6-103686-9	6-103687-9	1-103688-9
21	2.098 [53.29]	7-103903-0	7-103684-0	7-103685-0	7-103902-0	7-103686-0	7-103687-0	2-103688-0
22	2.198 [55.83]	7-103903-1	7-103684-1	7-103685-1	7-103902-1	7-103686-1	7-103687-1	2-103688-1
23	2.298 [58.37]	7-103903-2	7-103684-2	7-103685-2	7-103902-2	7-103686-2	7-103687-2	2-103688-2
24	2.398 [60.91]	7-103903-3	7-103684-3	7-103685-3	7-103902-3	7-103686-3	7-103687-3	2-103688-3
25	2.498 [63.45]	7-103903-4	7-103684-4	7-103685-4	7-103902-4	7-103686-4	7-103687-4	2-103688-4

- Notes:** 1. Receptacle assemblies are furnished with strip contacts partially inserted into housing—contacts latched into “preload” windows. Contacts are fully inserted into housings automatically when terminated with Tyco Electronics application machines, or manually when terminated with Tyco Electronics pistol grip hand tool.
 2. Use **Extraction/Lance Reset Tool No. 843477-1** to remove receptacle contacts.
 3. Keying plugs are available, see page 253.

Note: All part numbers are RoHS compliant.

MTE Receptacle Assemblies—Polarized/Latching, Single-Row, .100 [2.54] Centerline



Preassembled housings in strip form are available in positions 2 thru 12. For ease of handling, positions 2 thru 5 are recommended when using the Tyco Electronics Manual Pistol Grip Tool.

Material and Finish

Housing — Black thermoplastic, 94V-0 rated

Contacts — Phosphor Bronze, plated as follows:

Plating A — Duplex plated .000030 [0.00076] gold on contact area, .000050 [0.00127] min. tin in crimp area, with entire contact underplated .000050 [0.00127] nickel

Plating B — Duplex plated .000015 [0.00038] gold on contact area, .000050 [0.00127] min. tin in crimp area, with entire contact underplated .000050 [0.00127] nickel

Plating C — .000100 [0.00254] tin over .000050 [0.00127] nickel on entire contact

Note: Insulation displacement contacts accept an insulation diameter of .030 [0.76] min. to .054 [1.37] max. with an insulation wall thickness of .015 [0.38] max. Mating post length for preloaded housings is .200 [5.08] min., .250 [6.35] max.

Related Product Data

Mateable AMPMODU Products

Pin Assemblies (Polarized/Latching) — pages 236, 237

Pin Assemblies with Guide Ribs (installed in Panel Mount Pin Shroud) — pages 238, 239, 242

Headers (Polarized/Latching) — pages 244-252

Interchangeable Crimp Contacts (Short Point) — page 253

Application Tooling — page 273

Performance Specifications — page 225

Technical Documents — pages 277, 278

Product Specification
108-25034

Application Specification
114-25026

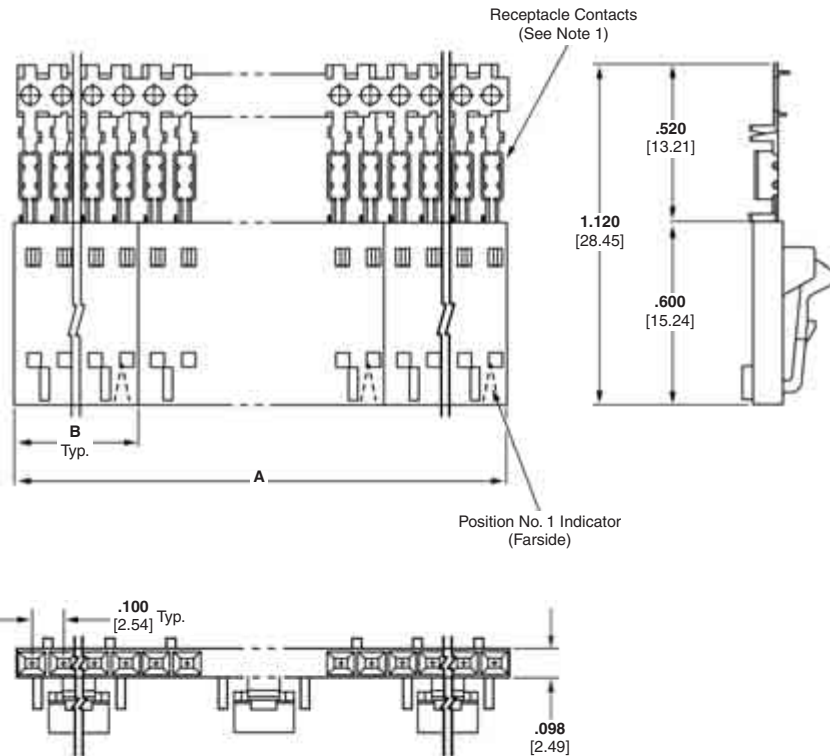

MTE Receptacle Assemblies—Strip Form Polarized/Latching, Single-Row, .100 [2.54] Centerline (Continued)

No. of Pos.	Dimensions		Housing Quantities Per Strip Segment	Strip Form Receptacle Assembly 30-26 AWG [0.05-0.15mm ²] Wire			Strip Form Receptacle Assembly 26-22 AWG [0.12-0.3mm ²] Wire			Unloaded Housings
	A	B		Plating A	Plating B	Plating C	Plating A	Plating B	Plating C	
2	2.000 [50.80]	.198 [5.03]	10	5-103961-1	5-103960-1	5-103959-1	5-103958-1	5-103957-1	5-103956-1	104257-1
3	2.400 [60.96]	.298 [7.57]	8	5-103961-2	5-103960-2	5-103959-2	5-103958-2	5-103957-2	5-103956-2	104257-2
4	1.990 [50.55]	.398 [10.11]	5	5-103961-3	5-103960-3	5-103959-3	5-103958-3	5-103957-3	5-103956-3	104257-3
5	1.990 [50.55]	.498 [12.65]	4	5-103961-4	5-103960-4	5-103959-4	5-103958-4	5-103957-4	5-103956-4	104257-4
6	2.390 [60.71]	.598 [15.19]	4	5-103961-5	5-103960-5	5-103959-5	5-103958-5	5-103957-5	5-103956-5	104257-5
7	1.400 [35.56]	.698 [17.73]	2	5-103961-6	5-103960-6	5-103959-6	5-103958-6	5-103957-6	5-103956-6	104257-6
8	1.600 [40.64]	.798 [20.27]	2	5-103961-7	5-103960-7	5-103959-7	5-103958-7	5-103957-7	5-103956-7	104257-7
9	1.800 [45.72]	.898 [22.81]	2	5-103961-8	5-103960-8	5-103959-8	5-103958-8	5-103957-8	5-103956-8	104257-8
10	2.000 [50.80]	.998 [23.35]	2	5-103961-9	5-103960-9	5-103959-9	5-103958-9	5-103957-9	5-103956-9	104257-9
11	2.200 [55.88]	1.098 [27.89]	2	6-103961-0	6-103960-0	6-103959-0	6-103958-0	6-103957-0	6-103956-0	1-104257-0
12	2.400 [60.96]	1.198 [30.43]	2	6-103961-1	6-103960-1	6-103959-1	6-103958-1	6-103957-1	6-103956-1	1-104257-1

MTE Receptacle Assemblies—Individual Form Polarized/Latching, Single-Row, .100 [2.54] Centerline

No. of Pos.	Dimensions B	Individual Receptacle Assembly 30-26 AWG [0.05-0.15mm ²] Wire			Individual Receptacle Assembly 26-22 AWG [0.12-0.3mm ²] Wire			Unloaded Housings
		Plating A	Plating B	Plating C	Plating A	Plating B	Plating C	
13	1.298 [32.96]	6-103897-2	6-103640-2	6-103641-2	6-103734-2	6-103644-2	6-103645-2	1-104257-2
14	1.398 [35.51]	6-103897-3	6-103640-3	6-103641-3	6-103734-3	6-103644-3	6-103645-3	1-104257-3
15	1.498 [38.05]	6-103897-4	6-103640-4	6-103641-4	6-103734-4	6-103644-4	6-103645-4	1-104257-4
16	1.598 [40.59]	6-103897-5	6-103640-5	6-103641-5	6-103734-5	6-103644-5	6-103645-5	1-104257-5
17	1.698 [43.13]	6-103897-6	6-103640-6	6-103641-6	6-103734-6	6-103644-6	6-103645-6	1-104257-6
18	1.798 [45.67]	6-103897-7	6-103640-7	6-103641-7	6-103734-7	6-103644-7	6-103645-7	1-104257-7
19	1.898 [48.20]	6-103897-8	6-103640-8	6-103641-8	6-103734-8	6-103644-8	6-103645-8	1-104257-8
20	1.998 [50.75]	6-103897-9	6-103640-9	6-103641-9	6-103734-9	6-103644-9	6-103645-9	1-104257-9
21	2.098 [53.29]	7-103897-0	7-103640-0	7-103641-0	7-103734-0	7-103644-0	7-103645-0	2-104257-0
22	2.198 [55.83]	7-103897-1	7-103640-1	7-103641-1	7-103734-1	7-103644-1	7-103645-1	2-104257-1
23	2.298 [58.37]	7-103897-2	7-103640-2	7-103641-2	7-103734-2	7-103644-2	7-103645-2	2-104257-2
24	2.398 [60.91]	7-103897-3	7-103640-3	7-103641-3	7-103734-3	7-103644-3	7-103645-3	2-104257-3
25	2.498 [63.45]	7-103897-4	7-103640-4	7-103641-4	7-103734-4	7-103644-4	7-103645-4	2-104257-4

- Notes:** 1. Receptacle assemblies are furnished with strip contacts partially inserted into housing—contacts latched into “preload” windows. Contacts are fully inserted into housings automatically when terminated with Tyco Electronics application machines, or manually when terminated with Tyco Electronics pistol grip hand tool.
 2. Use **Extraction/Lance Reset Tool No. 843477-1** to remove receptacle contacts.
 3. Keying plugs are available, see page 253.

Note: All part numbers are RoHS compliant.

**MTE Receptacle Assemblies—Guide Ribs,
Single-Row, .100 [2.54] Centerline**



Preassembled housings in strip form are available in positions 2 thru 12. For ease of handling, positions 2 thru 5 are recommended when using the Tyco Electronics Manual Pistol Grip Tool.

Material and Finish

Housing — Black thermoplastic, 94V-0 rated

Contacts — Phosphor Bronze, plated as follows:

Plating A — Duplex plated .000030 [0.00076] gold on contact area, .000050 [0.00127] min. tin in crimp area, with entire contact underplated .000050 [0.00127] nickel

Plating B — Duplex plated .000015 [0.00038] gold on contact area, .000050 [0.00127] min. tin in crimp area, with entire contact underplated .000050 [0.00127] nickel

Plating C — .000100 [0.00254] tin over .000050 [0.00127] nickel on entire contact

Note: Insulation displacement contacts accept an insulation diameter of .030 [0.76] min. to .054 [1.37] max. with an insulation wall thickness of .015 [0.38] max. Mating post length for preloaded housings is .200 [5.08] min., .250 [6.35] max.

Related Product Data

Coupling Shrouds used with —
Single-Row — page 240
Double-Row — page 241

Mateable AMPMODU Products (with Receptacle Assemblies Installed in Single-Row Coupling Shrouds) —

Pin Assemblies (Polarized/Latching) — pages 236, 237

Pin Assemblies with Guide Ribs (installed in Panel Mount Pin Shroud) — pages 238, 239, 242

Headers (Polarized/Latching) — pages 244-252

Mateable AMPMODU Products (with Receptacle Assemblies Installed in Double-Row Coupling Shrouds) —

Headers, Shrouded, Double-Row (.318 [8.08] mating post length, .150 [3.81] end dimension) — pages 119-121, 124, 125, 128, 129, 131-133

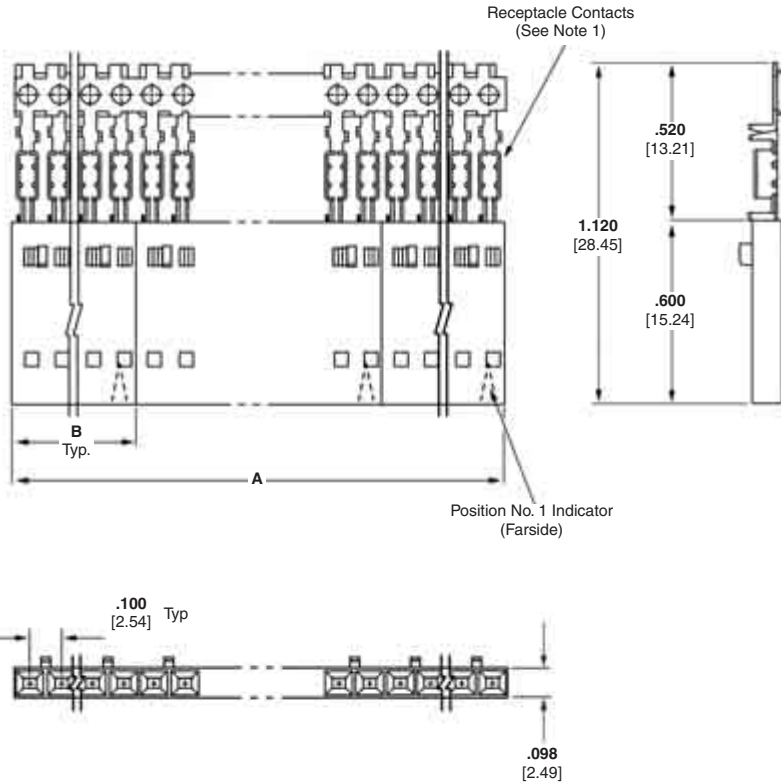

Interchangeable Crimp Contacts—
 (Short Point) — page 253

Application Tooling — page 273

Performance Specifications — page 225

Technical Documents — pages 277, 278

Product Specification
 108-25034

Application Specification
 114-25026

MTE Receptacle Assemblies—Strip Form with Guide Ribs, Single-Row, .100 [2.54] Centerline (Continued)

No. of Pos.	Dimensions		Housing Quantities Per Strip Segment	Strip Form Receptacle Assembly 30-26 AWG [0.05-0.15mm ²] Wire			Strip Form Receptacle Assembly 26-22 AWG [0.12-0.3mm ²] Wire			Unloaded Housings
	A	B		Plating A	Plating B	Plating C	Plating A	Plating B	Plating C	
2	2.000 [50.80]	.198 [5.03]	10	5-103973-1	5-103972-1	5-103971-1	5-103970-1	5-103969-1	5-103968-1	103648-1
3	2.400 [60.96]	.298 [7.57]	8	5-103973-2	5-103972-2	5-103971-2	5-103970-2	5-103969-2	5-103968-2	103648-2
4	1.990 [50.55]	.398 [10.11]	5	5-103973-3	5-103972-3	5-103971-3	5-103970-3	5-103969-3	5-103968-3	103648-3
5	1.990 [50.55]	.498 [12.65]	4	5-103973-4	5-103972-4	5-103971-4	5-103970-4	5-103969-4	5-103968-4	103648-4
6	2.390 [60.71]	.598 [15.19]	4	5-103973-5	5-103972-5	5-103971-5	5-103970-5	5-103969-5	5-103968-5	103648-5
7	1.400 [35.56]	.698 [17.73]	2	5-103973-6	5-103972-6	5-103971-6	5-103970-6	5-103969-6	5-103968-6	103648-6
8	1.600 [40.64]	.798 [20.27]	2	5-103973-7	5-103972-7	5-103971-7	5-103970-7	5-103969-7	5-103968-7	103648-7
9	1.800 [45.72]	.898 [22.81]	2	5-103973-8	5-103972-8	5-103971-8	5-103970-8	5-103969-8	5-103968-8	103648-8
10	2.000 [50.80]	.998 [23.35]	2	5-103973-9	5-103972-9	5-103971-9	5-103970-9	5-103969-9	5-103968-9	103648-9
11	2.200 [55.88]	1.098 [27.89]	2	6-103973-0	6-103972-0	6-103971-0	6-103970-0	6-103969-0	6-103968-0	1-103648-0
12	2.400 [60.96]	1.198 [30.43]	2	6-103973-1	6-103972-1	6-103971-1	6-103970-1	6-103969-1	6-103968-1	1-103648-1

MTE Receptacle Assemblies—Individual Form with Guide Ribs, Single-Row, .100 [2.54] Centerline

No. of Pos.	Dimensions B	Individual Receptacle Assembly 30-26 AWG [0.05-0.15mm ²] Wire			Individual Receptacle Assembly 26-22 AWG [0.12-0.3mm ²] Wire			Unloaded Housings
		Plating A	Plating B	Plating C	Plating A	Plating B	Plating C	
13	1.298 [32.96]	6-103901-2	6-103649-2	6-103650-2	6-103900-2	6-103651-2	6-103652-2	1-103648-2
14	1.398 [35.51]	6-103901-3	6-103649-3	6-103650-3	6-103900-3	6-103651-3	6-103652-3	1-103648-3
15	1.498 [38.05]	6-103901-4	6-103649-4	6-103650-4	6-103900-4	6-103651-4	6-103652-4	1-103648-4
16	1.598 [40.59]	6-103901-5	6-103649-5	6-103650-5	6-103900-5	6-103651-5	6-103652-5	1-103648-5
17	1.698 [43.13]	6-103901-6	6-103649-6	6-103650-6	6-103900-6	6-103651-6	6-103652-6	1-103648-6
18	1.798 [45.67]	6-103901-7	6-103649-7	6-103650-7	6-103900-7	6-103651-7	6-103652-7	1-103648-7
19	1.898 [48.20]	6-103901-8	6-103649-8	6-103650-8	6-103900-8	6-103651-8	6-103652-8	1-103648-8
20	1.998 [50.75]	6-103901-9	6-103649-9	6-103650-9	6-103900-9	6-103651-9	6-103652-9	1-103648-9
21	2.098 [53.29]	7-103901-0	7-103649-0	7-103650-0	7-103900-0	7-103651-0	7-103652-0	2-103648-0
22	2.198 [55.83]	7-103901-1	7-103649-1	7-103650-1	7-103900-1	7-103651-1	7-103652-1	2-103648-1
23	2.298 [58.37]	7-103901-2	7-103649-2	7-103650-2	7-103900-2	7-103651-2	7-103652-2	2-103648-2
24	2.398 [60.91]	7-103901-3	7-103649-3	7-103650-3	7-103900-3	7-103651-3	7-103652-3	2-103648-3
25	2.498 [63.45]	7-103901-4	7-103649-4	7-103650-4	7-103900-4	7-103651-4	7-103652-4	2-103648-4

- Notes:**
1. Receptacle assemblies are furnished with strip contacts partially inserted into housing—contacts latched into “preload” windows. Contacts are fully inserted into housings automatically when terminated with Tyco Electronics application machines, or manually when terminated with Tyco Electronics pistol grip hand tool.
 2. Use **Extraction/Lance Reset Tool No. 843477-1** to remove receptacle contacts.
 3. Keying plugs are available, see page 253.

Note: All part numbers are RoHS compliant.

MTE High Pressure Receptacle Assemblies—Plain, Single-Row, .100 [2.54] Centerline



Preassembled housings in strip form are available in positions 2 thru 12. For ease of handling, positions 2 thru 5 are recommended when using the Tyco Electronics Manual Pistol Grip Tool.

Material and Finish

Housing — Black thermoplastic, 94V-0 rated

Contacts — Phosphor Bronze, duplex plated .000030 [0.00076] gold on contact area, .000050 [0.00127] min. tin in crimp area, with entire contact underplated .000050 [0.00127] nickel

Note: Insulation displacement contacts accept an insulation diameter of .030 [0.76] min. to .054 [1.37] max. with an insulation wall thickness of .015 [0.38] max. Mating post length for preloaded housings is .200 [5.08] min., .250 [6.35] max.

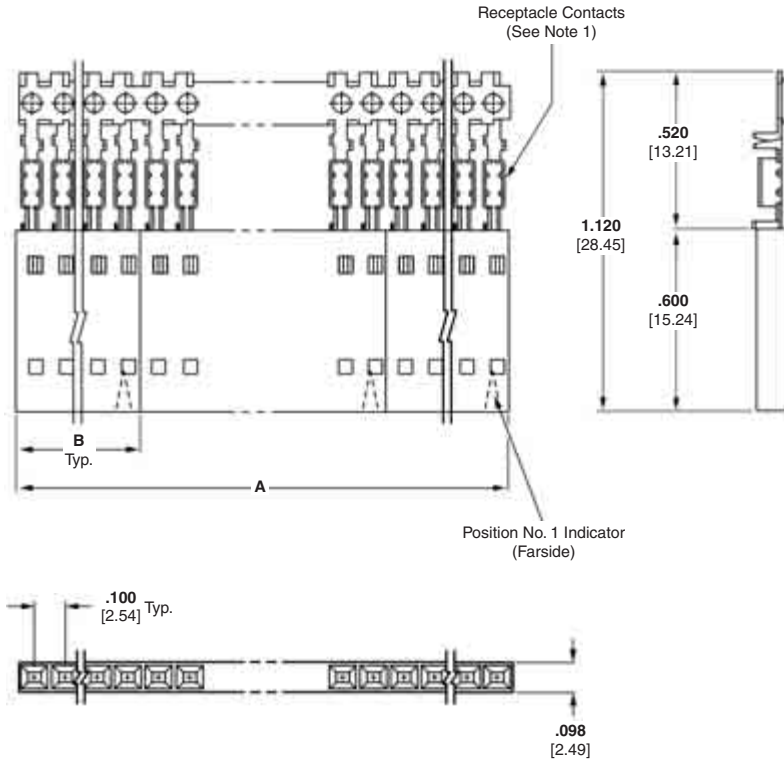

Related Product Data

Mateable AMPMODU Products

Breakaway Headers — pages 102-110, (with .230 mating length)

Reeled Breakaway Headers — pages 106, 107 (with .230 mating length)

Machine Applied Bandolier Posts — page 163

Application Tooling — page 273

Performance Specifications — page 225

Technical Documents — pages 277, 278)

Product Specification 108-25034

Application Specification 114-25026

No. of Pos.	Dimensions		Housings Quantities Per Strip Segment	Strip Form Receptacle Assembly	Strip Form Receptacle Assembly
	A	B		30-26 AWG [.05-.15mm ²] Wire	26-22 AWG [.12-.30mm ²] Wire
2	1.980 [50.29]	.198 [5.03]	10	5-104438-1	5-104439-1
3	1.490 [37.85]	.298 [7.57]	5	5-104438-2	5-104439-2
4	1.990 [50.55]	.398 [10.11]	5	5-104438-3	5-104439-3
5	1.990 [50.55]	.498 [12.65]	4	5-104438-4	5-104439-4
6	2.390 [60.71]	.598 [15.19]	4	5-104438-5	5-104439-5
7	1.400 [35.56]	.698 [17.73]	2	5-104438-6	5-104439-6
8	1.600 [40.64]	.798 [20.27]	2	5-104438-7	5-104439-7
9	1.800 [45.72]	.898 [22.81]	2	5-104438-8	5-104439-8
10	2.000 [50.80]	.998 [23.35]	2	5-104438-9	5-104439-9
11	2.200 [55.88]	1.098 [27.89]	2	6-104438-0	6-104439-0
12	2.400 [60.96]	1.198 [30.43]	2	6-104438-1	6-104439-1

- Notes:**
1. Receptacle assemblies are furnished with strip contacts partially inserted into housing—contacts latched into “preload” windows. Contacts are fully inserted into housings automatically when terminated with Tyco Electronics application machines, or manually when terminated with Tyco Electronics pistol grip hand tool.
 2. High pressure receptacle contacts can be made available in other housing styles and position sizes. Contact your Tyco Electronics sales representative.

Note: All part numbers are RoHS compliant.

MTE High Pressure Receptacle Assemblies – Guide Ribs



Preassembled housings in strip form are available in positions 2 thru 12. For ease of handling, positions 2 thru 5 are recommended when using the Tyco Electronics Manual Pistol Grip Tool.

Material and Finish

Housing — Thermoplastic, black, 94V-0 rated

Contacts — Phosphor Bronze, duplex plated .000030 [0.00076] gold on contact area, .000050 [0.00127] min. tin on crimp area, with entire contact underplated .000050 [0.00127] nickel.

Related Product Data

Coupling Shrouds used with —
Single-Row — page 240
Double-Row — page 241

Mateable AMPMODU Products (with Receptacle Assemblies Installed in Single-Row Coupling Shrouds) —

Pin Assemblies (Polarized/Latching) — pages 236, 237

Pin Assemblies with Guide Ribs (installed in Panel Mount Pin Shroud) — pages 238, 239, 242

Headers (Polarized/Latching) — pages 244-252

Mateable AMPMODU Products (with Receptacle Assemblies Installed in Double-Row Coupling Shrouds) —

Headers, Shrouded, Double-Row (.318 [8.08] mating post length, .150 [3.81] end dimension) — pages 119-121, 124, 125, 128, 129, 131-133

Application Tooling — page 273

Performance Specifications — page 225

Technical Documents — pages 277, 278

Product Specification
108-25034

Application Specification
114-25026

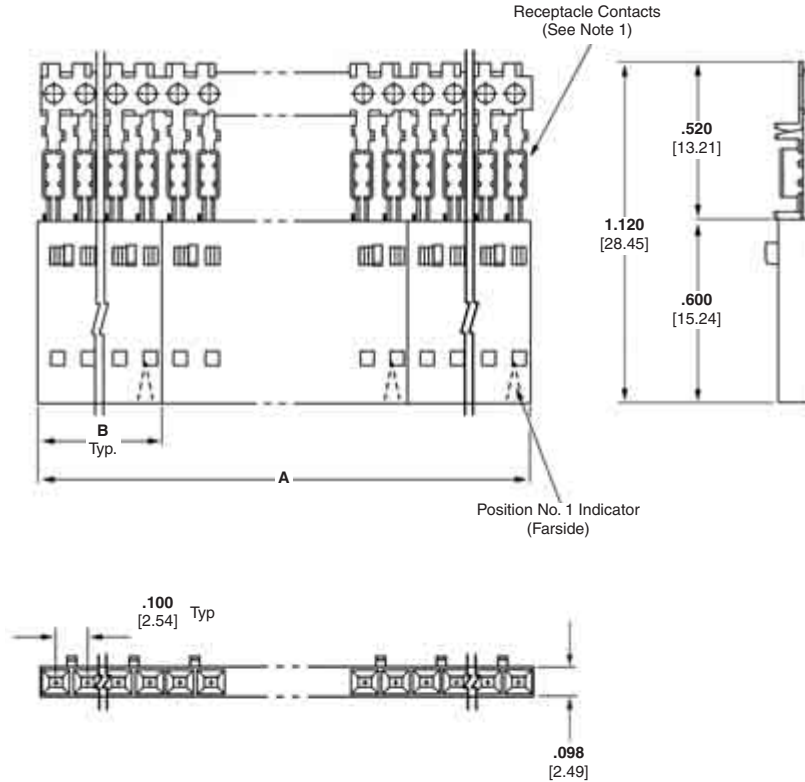

No. of Pos.	Dimensions		Housings Quantities Per Strip Segment	Strip Form Receptacle Assembly 30-26 AWG [.05-.15mm ²] Wire	Strip Form Receptacle Assembly 26-22 AWG [.12-.30mm ²] Wire
	A	B			
2	1.980 [50.29]	.198 [5.03]	10	5-147396-1	5-147030-3
3	1.490 [37.85]	.298 [7.57]	5	5-147396-2	5-147030-4
4	1.990 [50.55]	.398 [10.11]	5	5-147396-3	5-147030-1
5	1.990 [50.55]	.498 [12.65]	4	5-147396-4	5-147030-2
6	2.390 [60.71]	.598 [15.19]	4	5-147396-5	5-147030-5
7	1.400 [35.56]	.698 [17.73]	2	5-147396-6	5-147030-6
8	1.600 [40.64]	.798 [20.27]	2	5-147396-7	5-147030-7
9	1.800 [45.72]	.898 [22.81]	2	5-147396-8	5-147030-8
10	2.000 [50.80]	.998 [23.35]	2	5-147396-9	5-147030-9
11	2.200 [55.88]	1.098 [27.89]	2	6-147396-0	6-147030-0
12	2.400 [60.96]	1.198 [30.43]	2	6-147396-1	6-147030-1

Note: All part numbers are RoHS compliant.

**MTE Pin Assemblies, Shrouded—Polarized/Latching,
Single-Row, .100 [2.54] Centerline**

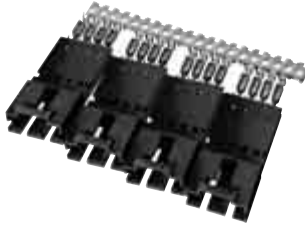

Preassembled housings in strip form are available in positions 2 thru 12. For ease of handling, positions 2 thru 5 are recommended when using the Tyco Electronics Manual Pistol Grip Tool.

Material and Finish

Housing — Black thermoplastic, 94V-0 rated

Contacts — Phosphor Bronze, plated as follows:

Plating A — Duplex plated .000030 [0.00076] gold on contact area, .000050 [0.00127] min. tin in crimp area, with entire contact underplated .000050 [0.00127] nickel

Plating B — Duplex plated .000015 [0.00038] gold on contact area, .000050 [0.00127] min. tin in crimp area, with entire contact underplated .000050 [0.00127] nickel

Plating C — .000100 [0.00254] tin over .000050 [0.00127] nickel on entire contact

Note: Insulation displacement contacts accept an insulation diameter of .030 [0.76] min. to .054 [1.37] max. with an insulation wall thickness of .015 [0.38] max.

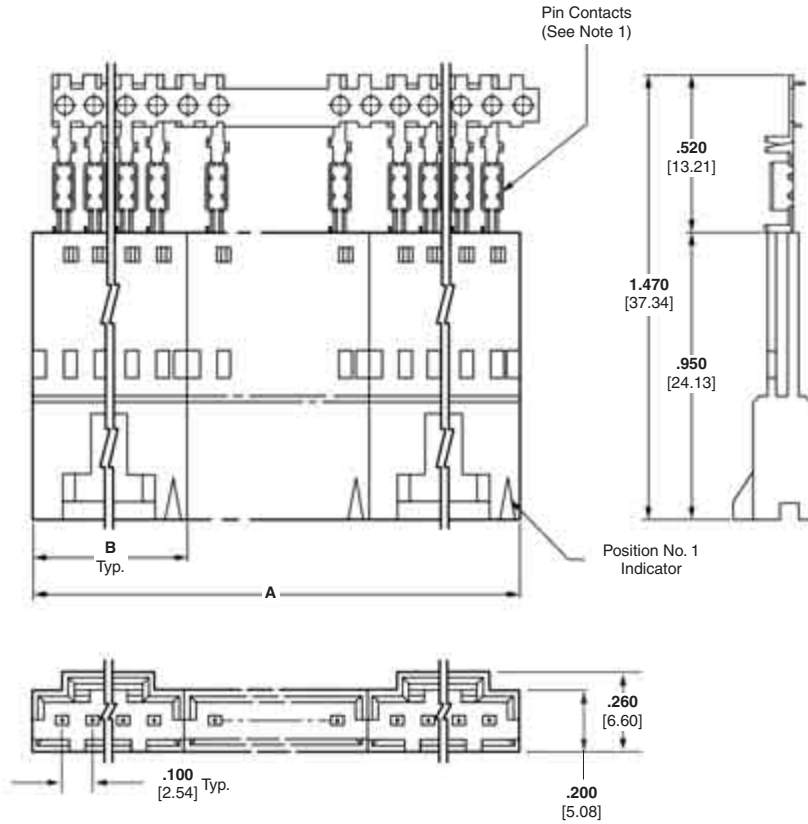

Related Product Data

Mateable AMPMODU Products —

Receptacle Assemblies (Polarized/Latching) — pages 230, 231

Receptacle Assemblies with Guide Ribs (installed in Single-Row Coupling Shroud) — pages 232, 233, 235, 240

Interchangeable Crimp Contacts — page 254

Application Tooling — page 273

Performance Specifications — page 225

Technical Documents — pages 277, 278

Product Specification
108-25034

Application Specification
114-25026

MTE Pin Assemblies, Shrouded—Strip Form Polarized/Latching, Single-Row, .100 [2.54] Centerline (Continued)

No. of Pos.	Dimensions		Housing Quantities Per Strip Segment	Strip Form Pin Assembly 30-26 AWG [0.05-0.15mm ²] Wire			Strip Form Pin Assembly 26-22 AWG [0.12-0.3mm ²] Wire			Unloaded Housings
	A	B		Plating A	Plating B	Plating C	Plating A	Plating B	Plating C	
2	2.360 [59.94]	.295 [7.49]	8	5-103949-1	5-103948-1	5-103947-1	5-103946-1	5-103945-1	5-103944-1	103653-1
3	1.980 [50.29]	.395 [10.03]	5	5-103949-2	5-103948-2	5-103947-2	5-103946-2	5-103945-2	5-103944-2	103653-2
4	1.980 [50.29]	.495 [12.57]	4	5-103949-3	5-103948-3	5-103947-3	5-103946-3	5-103945-3	5-103944-3	103653-3
5	2.380 [60.45]	.595 [15.11]	4	5-103949-4	5-103948-4	5-103947-4	5-103946-4	5-103945-4	5-103944-4	103653-4
6	1.390 [35.31]	.695 [17.65]	2	5-103949-5	5-103948-5	5-103947-5	5-103946-5	5-103945-5	5-103944-5	103653-5
7	2.390 [60.71]	.795 [20.19]	3	5-103949-6	5-103948-6	5-103947-6	5-103946-6	5-103945-6	5-103944-6	103653-6
8	1.790 [45.47]	.895 [22.73]	2	5-103949-7	5-103948-7	5-103947-7	5-103946-7	5-103945-7	5-103944-7	103653-7
9	1.990 [50.57]	.995 [25.27]	2	5-103949-8	5-103948-8	5-103947-8	5-103946-8	5-103945-8	5-103944-8	103653-8
10	2.190 [55.63]	1.095 [27.81]	2	5-103949-9	5-103948-9	5-103947-9	5-103946-9	5-103945-9	5-103944-9	103653-9
11	2.390 [60.71]	1.195 [30.35]	2	6-103949-0	6-103948-0	6-103947-0	6-103946-0	6-103945-0	6-103944-0	1-103653-0
12	2.590 [65.79]	1.295 [32.89]	2	6-103949-1	6-103948-1	6-103947-1	6-103946-1	6-103945-1	6-103944-1	1-103653-1

MTE Pin Assemblies, Shrouded—Individual Form Polarized/Latching, Single-Row, .100 [2.54] Centerline

No. of Pos.	Dimensions B	Individual Pin Assembly 30-26 AWG [0.05-0.15mm ²] Wire			Individual Pin Assembly 26-22 AWG [0.12-0.3mm ²] Wire			Unloaded Housings
		Plating A	Plating B	Plating C	Plating A	Plating B	Plating C	
13	1.395 [35.43]	6-103894-2	6-103658-2	6-103659-2	6-103893-2	6-103660-2	6-103661-2	1-103653-2
14	1.495 [37.97]	6-103894-3	6-103658-3	6-103659-3	6-103893-3	6-103660-3	6-103661-3	1-103653-3
15	1.595 [40.51]	6-103894-4	6-103658-4	6-103659-4	6-103893-4	6-103660-4	6-103661-4	1-103653-4
16	1.695 [43.05]	6-103894-5	6-103658-5	6-103659-5	6-103893-5	6-103660-5	6-103661-5	1-103653-5
17	1.795 [45.59]	6-103894-6	6-103658-6	6-103659-6	6-103893-6	6-103660-6	6-103661-6	1-103653-6
18	1.895 [48.13]	6-103894-7	6-103658-7	6-103659-7	6-103893-7	6-103660-7	6-103661-7	1-103653-7
19	1.995 [50.67]	6-103894-8	6-103658-8	6-103659-8	6-103893-8	6-103660-8	6-103661-8	1-103653-8
20	2.095 [53.21]	6-103894-9	6-103658-9	6-103659-9	6-103893-9	6-103660-9	6-103661-9	1-103653-9
21	2.195 [55.75]	7-103894-0	7-103658-0	7-103659-0	7-103893-0	7-103660-0	7-103661-0	2-103653-0
22	2.295 [58.29]	7-103894-1	7-103658-1	7-103659-1	7-103893-1	7-103660-1	7-103661-1	2-103653-1
23	2.395 [60.83]	7-103894-2	7-103658-2	7-103659-2	7-103893-2	7-103660-2	7-103661-2	2-103653-2
24	2.495 [63.37]	7-103894-3	7-103658-3	7-103659-3	7-103893-3	7-103660-3	7-103661-3	2-103653-3
25	2.595 [65.91]	7-103894-4	7-103658-4	7-103659-4	7-103893-4	7-103660-4	7-103661-4	2-103653-4

- Notes:** 1. Pin assemblies are furnished with strip contacts partially inserted into housing—contacts latched into “preload” windows. Contacts are fully inserted into housings automatically when terminated with Tyco Electronics application machines, or manually when terminated with Tyco Electronics pistol grip hand tool.
 2. Use **Extraction/Lance Reset Tool No. 843477-1** to remove pin contacts.

Note: All part numbers are RoHS compliant.

**MTE Pin Assemblies—Guide Ribs,
Single-Row, .100 [2.54] Centerline**



Preassembled housings in strip form are available in positions 2 thru 12. For ease of handling, positions 2 thru 5 are recommended when using the Tyco Electronics Manual Pistol Grip Tool.

Material and Finish

Housing — Black thermoplastic, 94V-0 rated

Contacts — Phosphor Bronze, plated as follows:

Plating A — Duplex plated .000030 [0.00076] gold on contact area, .000050 [0.00127] min. tin in crimp area, with entire contact underplated .000050 [0.00127] nickel

Plating B — Duplex plated .000015 [0.00038] gold on contact area, .000050 [0.00127] min. tin in crimp area, with entire contact underplated .000050 [0.00127] nickel

Plating C — .000100 [0.00254] tin over .000050 [0.00127] nickel on entire contact

Note: Insulation displacement contacts accept an insulation diameter of .030 [0.76] min. to .054 [1.37] max. with an insulation wall thickness of .015 [0.38] max.

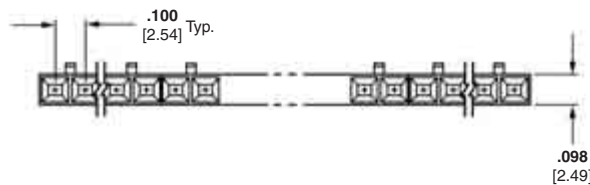
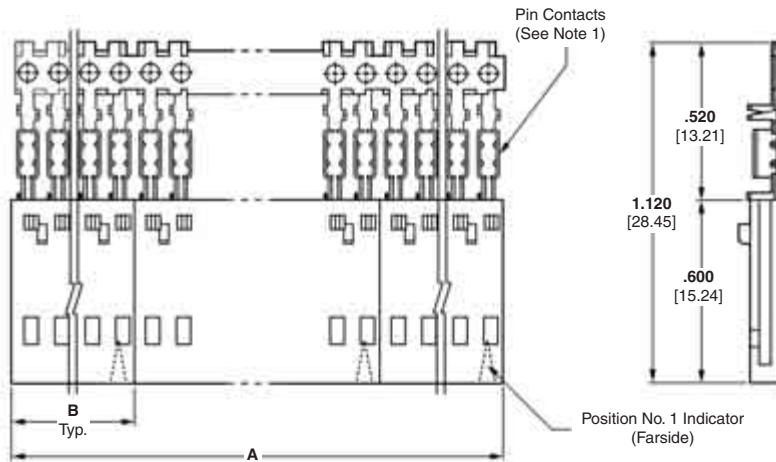

Related Product Data

Mateable AMPMODU MTE Products (with Pin Assembly Installed in Panel Mount Pin Shroud) — pages 242, 243

Receptacle Assemblies (Polarized/Latching) — pages 230, 231

Receptacle Assemblies with Guide Ribs (installed in Single Row Coupling Shroud) — pages 232, 233, 235, 240

Interchangeable Crimp Contacts — page 254

Application Tooling — page 273

Performance Specifications — page 225

Technical Documents — pages 277, 278

Product Specification
108-25034

Application Specification
114-25026

MTE Pin Assemblies—Strip Form with Guide Ribs, Single-Row, .100 [2.54] Centerline (Continued)

No. of Pos.	Dimensions		Housing Quantities Per Strip Segment	Strip Form Pin Assembly 30-26 AWG [0.05-0.15mm ²] Wire			Strip Form Pin Assembly 26-22 AWG [0.12-0.3mm ²] Wire			Unloaded Housings
	A	B		Plating A	Plating B	Plating C	Plating A	Plating B	Plating C	
2	1.980 [50.29]	0.198 [5.03]	10	5-103955-1	5-103954-1	5-103953-1	5-103952-1	5-103951-1	5-103950-1	104503-1
3	1.490 [37.85]	0.298 [7.57]	5	5-103955-2	5-103954-2	5-103953-2	5-103952-2	5-103951-2	5-103950-2	104503-2
4	1.990 [50.55]	0.398 [10.11]	5	5-103955-3	5-103954-3	5-103953-3	5-103952-3	5-103951-3	5-103950-3	104503-3
5	1.990 [50.55]	0.498 [12.65]	4	5-103955-4	5-103954-4	5-103953-4	5-103952-4	5-103951-4	5-103950-4	104503-4
6	2.390 [60.71]	0.598 [15.19]	4	5-103955-5	5-103954-5	5-103953-5	5-103952-5	5-103951-5	5-103950-5	104503-5
7	1.400 [35.56]	0.698 [17.73]	2	5-103955-6	5-103954-6	5-103953-6	5-103952-6	5-103951-6	5-103950-6	104503-6
8	1.600 [40.64]	0.798 [20.27]	2	5-103955-7	5-103954-7	5-103953-7	5-103952-7	5-103951-7	5-103950-7	104503-7
9	1.800 [45.72]	0.898 [22.81]	2	5-103955-8	5-103954-8	5-103953-8	5-103952-8	5-103951-8	5-103950-8	104503-8
10	2.000 [50.80]	0.998 [25.35]	2	5-103955-9	5-103954-9	5-103953-9	5-103952-9	5-103951-9	5-103950-9	104503-9
11	2.200 [55.88]	1.098 [27.89]	2	6-103955-0	6-103954-0	6-103953-0	6-103952-0	6-103951-0	6-103950-0	1-104503-0
12	2.400 [60.96]	1.198 [30.43]	2	6-103955-1	6-103954-1	6-103953-1	6-103952-1	6-103951-1	6-103950-1	1-104503-1

MTE Pin Assemblies—Individual Form with Guide Ribs, Single-Row, .100 [2.54] Centerline

No. of Pos.	Dimensions B	Individual Pin Assembly 30-26 AWG [0.05-0.15mm ²] Wire			Individual Pin Assembly 26-22 AWG [0.12-0.3mm ²] Wire			Unloaded Housings
		Plating A	Plating B	Plating C	Plating A	Plating B	Plating C	
13	1.398 [35.51]	6-103896-2	6-103657-2	6-103656-2	6-103895-2	6-103655-2	6-103654-2	1-104503-2
14	1.498 [38.05]	6-103896-3	6-103657-3	6-103656-3	6-103895-3	6-103655-3	6-103654-3	1-104503-3
15	1.598 [40.59]	6-103896-4	6-103657-4	6-103656-4	6-103895-4	6-103655-4	6-103654-4	1-104503-4
16	1.698 [43.13]	6-103896-5	6-103657-5	6-103656-5	6-103895-5	6-103655-5	6-103654-5	1-104503-5
17	1.798 [45.67]	6-103896-6	6-103657-6	6-103656-6	6-103895-6	6-103655-6	6-103654-6	1-104503-6
18	1.898 [48.20]	6-103896-7	6-103657-7	6-103656-7	6-103895-7	6-103655-7	6-103654-7	1-104503-7
19	1.998 [50.75]	6-103896-8	6-103657-8	6-103656-8	6-103895-8	6-103655-8	6-103654-8	1-104503-8
20	2.098 [53.29]	6-103896-9	6-103657-9	6-103656-9	6-103895-9	6-103655-9	6-103654-9	1-104503-9
21	2.198 [55.83]	7-103896-0	7-103657-0	7-103656-0	7-103895-0	7-103655-0	7-103654-0	2-104503-0
22	2.298 [58.37]	7-103896-1	7-103657-1	7-103656-1	7-103895-1	7-103655-1	7-103654-1	2-104503-1
23	2.398 [60.91]	7-103896-2	7-103657-2	7-103656-2	7-103895-2	7-103655-2	7-103654-2	2-104503-2
24	2.498 [63.45]	7-103896-3	7-103657-3	7-103656-3	7-103895-3	7-103655-3	7-103654-3	2-104503-3
25	2.598 [65.99]	7-103896-4	7-103657-4	7-103656-4	7-103895-4	7-103655-4	7-103654-4	2-104503-4

Notes: 1. Pin assemblies are furnished with strip contacts partially inserted into housing—contacts latched into “preload” windows. Contacts are fully inserted into housings automatically when terminated with Tyco Electronics application machines, or manually when terminated with Tyco Electronics pistol grip hand tool.

2. Use **Extraction/Lance Reset Tool No. 843477-1** to remove pin contacts.

Note: All part numbers are RoHS compliant.

Coupling Shrouds for MTE Receptacle Assemblies with Guide Ribs

Single-Row

Material

Black thermoplastic, 94V-0 rated

Technical Documents —
pages 277, 278

Product Specification
108-25034

Application Specification
114-25026

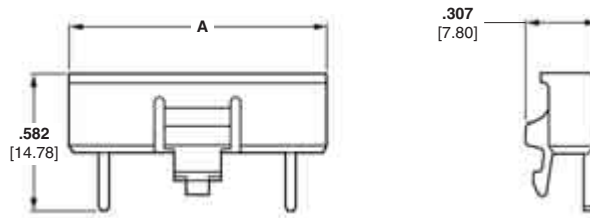

No. of Pos.	Dimension A	Single-Row Coupling Shroud
4	.485 [12.32]	103680-1
5	.585 [14.86]	103680-2
6	.685 [17.40]	103680-3
7	.785 [19.94]	103680-4
8	.885 [22.48]	103680-5
9	.985 [25.02]	103680-6
10	1.085 [27.56]	103680-7
11	1.185 [30.10]	103680-8
12	1.285 [32.64]	103680-9
13	1.385 [35.18]	1-103680-0
14	1.485 [37.72]	1-103680-1

No. of Pos.	Dimension A	Single-Row Coupling Shroud
15	1.585 [40.26]	1-103680-2
16	1.685 [42.80]	1-103680-3
17	1.785 [45.34]	1-103680-4
18	1.885 [47.88]	1-103680-5
19	1.985 [50.42]	1-103680-6
20	2.085 [52.96]	1-103680-7
21	2.185 [55.50]	1-103680-8
22	2.285 [58.04]	1-103680-9
23	2.385 [60.58]	2-103680-0
24	2.485 [63.12]	2-103680-1
25	2.585 [65.66]	2-103680-2

MTE Coupling Shrouds

5

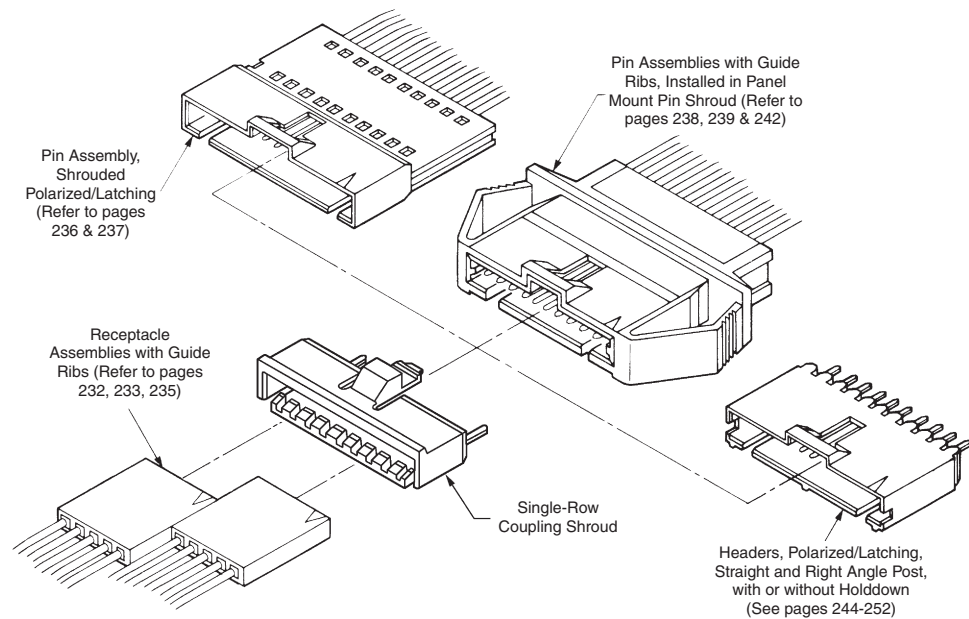

Typical Application of Single-Row Coupling Shroud and Mating AMPMODU MTE Products

Note: All part numbers are RoHS compliant.

Coupling Shrouds for MTE Receptacle Assemblies with Guide Ribs (Continued)

Double-Row

Material

Black thermoplastic, 94V-0 rated

Technical Documents —
pages 277, 278

Product Specification
108-25034

Application Specification
114-25026

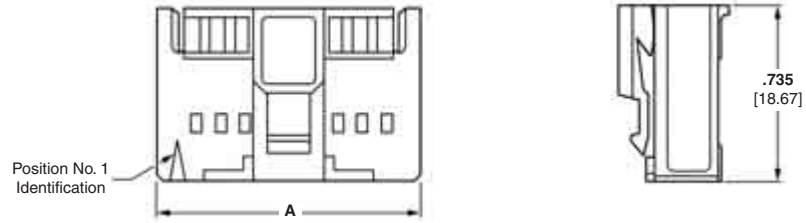

No. of Pos.	Dimension A	Double-Row Coupling Shroud
8	.585 [14.86]	103681-1
10	.685 [17.40]	103681-2
12	.785 [19.94]	103681-3
14	.885 [22.48]	103681-4
16	.985 [25.02]	103681-5
18	1.085 [27.56]	104500-1
20	1.185 [30.10]	104500-2
22	1.285 [32.64]	104500-3
24	1.385 [35.18]	104500-4
26	1.485 [37.72]	104500-5
28	1.585 [40.26]	104500-6
30	1.685 [42.80]	104500-7
32	1.785 [45.34]	104500-8
34	1.885 [47.88]	104500-9
40	2.185 [55.50]	1-104500-0
50	2.685 [68.20]	1-104500-1

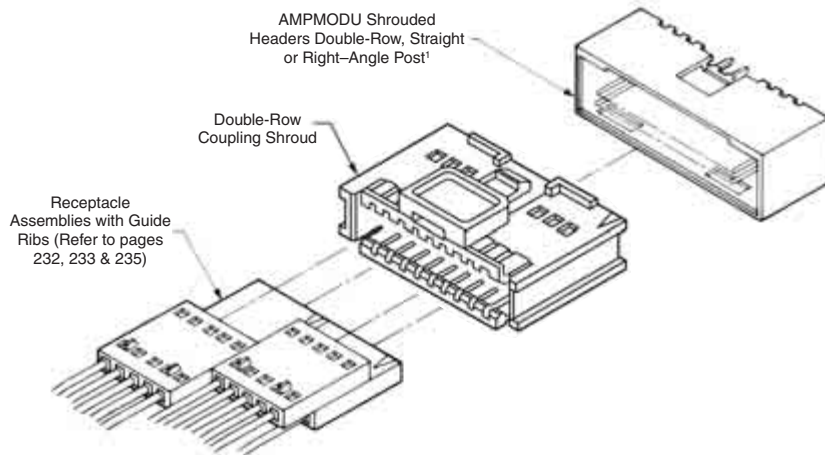

¹Mating AMPMODU Double-Row Shrouded Headers must have .318 [8.08] mating post length and .150 [3.81] dimension from centerline of last post to inside of end shroud wall.

Typical Application of Double-Row Coupling Shroud and Mating AMPMODU Products

Note: All part numbers are RoHS compliant.

Panel Mount Pin Shrouds for MTE Pin Assemblies with Guide Ribs, Single-Row

Material

Black thermoplastic, 94V-0 rated

Technical Documents — pages 277, 278

Product Specification
108-25034

Application Specification
114-25026

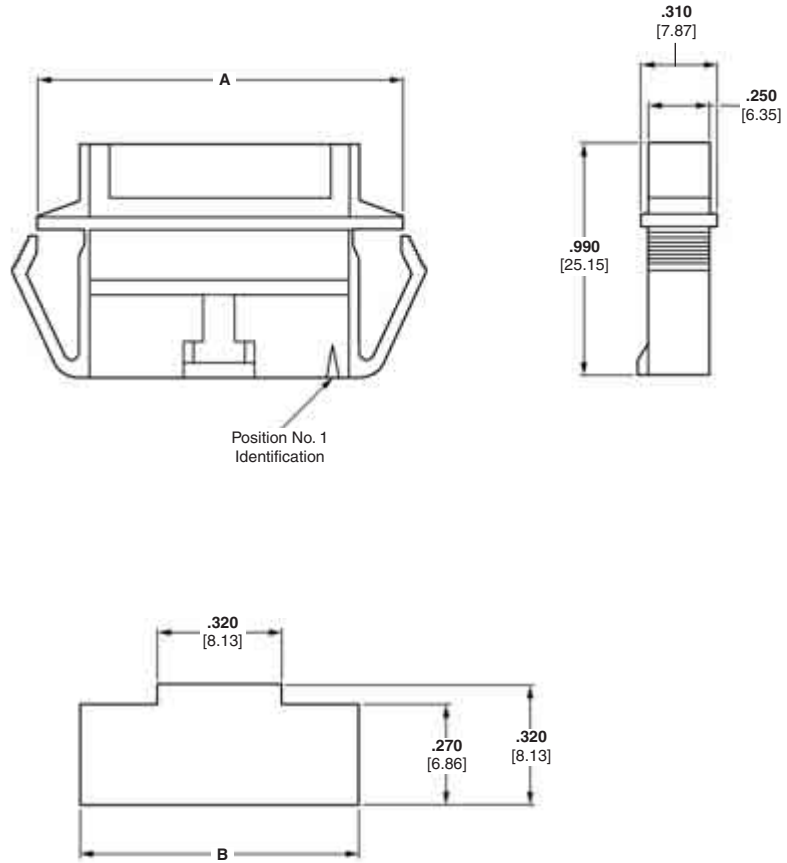

MTE Panel Mount Pin Shrouds

5

No. of Pos.	Dimensions		Panel Mount Pin Shroud
	A	B	
2	.735 [18.67]	.625 [15.88]	103682-1
3	.835 [21.21]	.725 [18.42]	103682-2
4	.935 [23.75]	.825 [20.96]	103682-3
5	1.035 [26.29]	.925 [23.50]	103682-4
6	1.135 [28.83]	1.025 [26.04]	103682-5
7	1.235 [31.37]	1.125 [28.58]	103682-6
8	1.335 [33.91]	1.225 [31.12]	103682-7
9	1.435 [36.45]	1.325 [33.66]	103682-8
10	1.535 [38.99]	1.425 [36.20]	103682-9
11	1.635 [41.53]	1.525 [38.74]	1-103682-0
12	1.735 [44.07]	1.625 [41.28]	1-103682-1
13	1.835 [46.61]	1.725 [43.82]	1-103682-2

No. of Pos.	Dimensions		Panel Mount Pin Shroud
	A	B	
14	1.935 [49.15]	1.825 [46.36]	1-103682-3
15	2.035 [51.69]	1.925 [48.90]	1-103682-4
16	2.135 [54.23]	2.025 [51.44]	1-103682-5
17	2.235 [56.77]	2.125 [53.98]	1-103682-6
18	2.335 [59.31]	2.225 [56.52]	1-103682-7
19	2.435 [61.85]	2.325 [59.06]	1-103682-8
20	2.535 [64.39]	2.425 [61.60]	1-103682-9
21	2.635 [66.93]	2.525 [64.14]	2-103682-0
22	2.735 [69.47]	2.625 [66.68]	2-103682-1
23	2.835 [72.01]	2.725 [69.22]	2-103682-2
24	2.935 [74.55]	2.825 [71.76]	2-103682-3
25	3.035 [77.09]	2.925 [74.30]	2-103682-4

Note: All part numbers are RoHS compliant.

Panel Mount Pin Shrouds for MTE Pin Assemblies with Guide Ribs, Single-Row (Continued)

Material

Black thermoplastic, 94V-0 rated

Technical Documents —
pages 277, 278

Product Specification
108-25034

Application Specification
114-25026

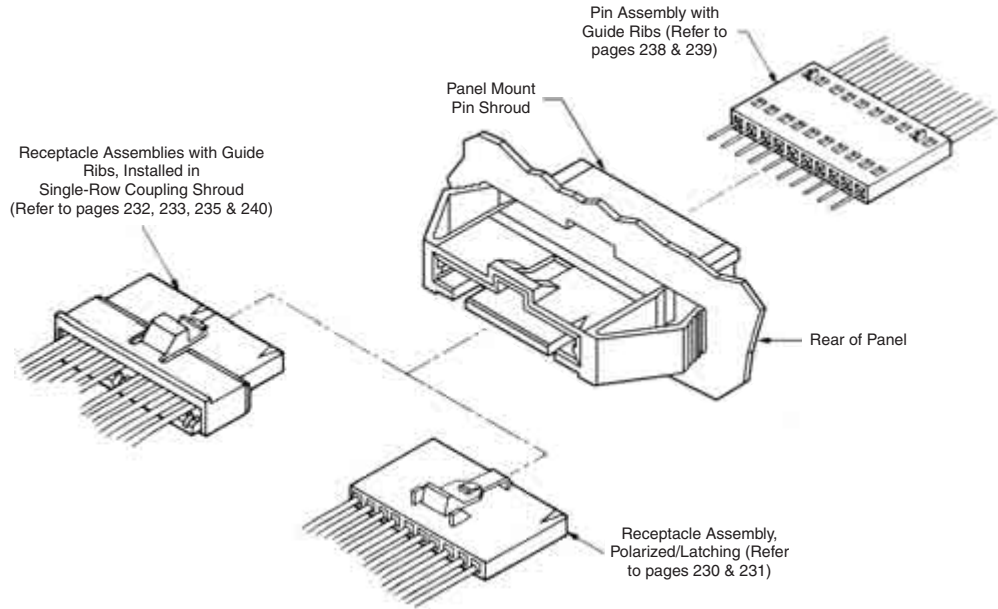

Typical Application of Panel Mount Pin Shroud and Mating AMPMODU Products

**MTE Headers, Shrouded Polarized/Latching,
Single-Row .100 [2.54] Centerline**

**.025 [0.64] Square
Straight Post (With or
Without Swaged Tail)**

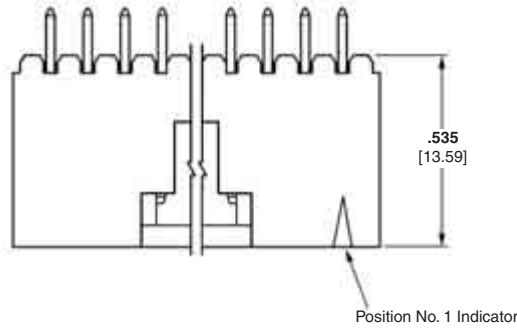

Swaged Retention Tail
(See Note)

Material and Finish

Housing — Black thermoplastic, 94V-0 rated

Posts — Brass, plated as follows:

Plating A — Duplex plated .000030 [0.00076] gold on contact area, .000100 [0.00254] min. tin on solder area, with entire post underplated .000050 [0.00127] nickel

Plating B — Duplex plated .000015 [0.00038] gold on contact area, .000100 [0.00254] min. tin on solder area, with entire post underplated .000050 [0.00127] nickel

Plating C — .000100 [0.00254] tin over .000050 [0.00127] nickel on entire post

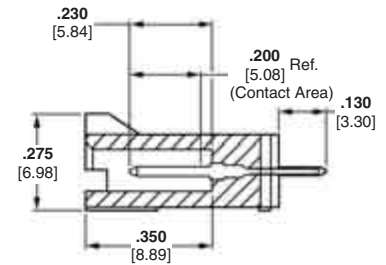
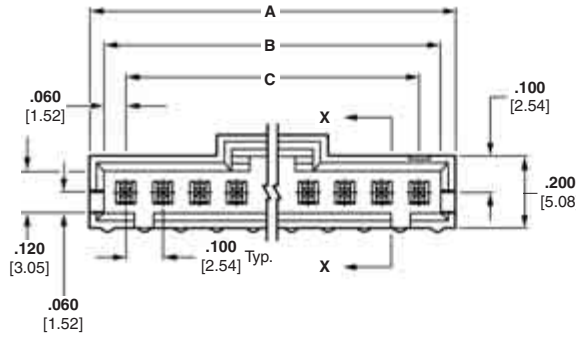

Section X-X

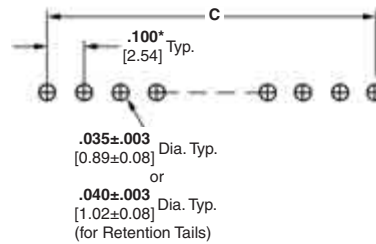

Recommended PC Board Hole Layout

*±.003 [±0.08]; tolerances not to accumulate within one connector pattern.

Note: Swaged retention tails are provided in a minimum of two locations per header.

Related Product Data

Mateable AMPMODU MTE Products —

Receptacle Assemblies (Polarized/Latching) — pages 230, 231

Receptacle Assemblies with Guide Ribs (installed in Single-Row Coupling Shroud) — pages 232, 233, 235, 240

Technical Documents — pages 277, 278

Product Specification
108-25034

Application Specification
114-25026

MTE Headers, Shrouded Polarized/Latching, Single-Row .100 [2.54] Centerline (Continued)

No. of Pos.	Dimensions			Polarized/Latching Header With Swage			Polarized/Latching Header Without Swage		
	A	B	C	Plating A	Plating B	Plating C	Plating A	Plating B	Plating C
2	.300 [7.62]	.220 [5.59]	.100 [2.54]	5-103908-1	5-104362-1	5-103669-1	5-103735-1	5-104363-1	5-103639-1
3	.400 [10.16]	.320 [8.13]	.200 [5.08]	5-103908-2	5-104362-2	5-103669-2	5-103735-2	5-104363-2	5-103639-2
4	.500 [12.70]	.420 [10.67]	.300 [7.62]	5-103908-3	5-104362-3	5-103669-3	5-103735-3	5-104363-3	5-103639-3
5	.600 [15.24]	.520 [13.21]	.400 [10.16]	5-103908-4	5-104362-4	5-103669-4	5-103735-4	5-104363-4	5-103639-4
6	.700 [17.78]	.620 [15.75]	.500 [12.70]	5-103908-5	5-104362-5	5-103669-5	5-103735-5	5-104363-5	5-103639-5
7	.800 [20.32]	.720 [18.29]	.600 [15.24]	5-103908-6	5-104362-6	5-103669-6	5-103735-6	5-104363-6	5-103639-6
8	.900 [22.86]	.820 [20.83]	.700 [17.78]	5-103908-7	5-104362-7	5-103669-7	5-103735-7	5-104363-7	5-103639-7
9	1.000 [25.40]	.920 [23.37]	.800 [20.32]	5-103908-8	5-104362-8	5-103669-8	5-103735-8	5-104363-8	5-103639-8
10	1.100 [27.94]	1.020 [25.91]	.900 [22.86]	5-103908-9	5-104362-9	5-103669-9	5-103735-9	5-104363-9	5-103639-9
11	1.200 [30.48]	1.120 [28.45]	1.000 [25.40]	6-103908-0	6-104362-0	6-103669-0	6-103735-0	6-104363-0	6-103639-0
12	1.300 [33.02]	1.220 [30.99]	1.100 [27.94]	6-103908-1	6-104362-1	6-103669-1	6-103735-1	6-104363-1	6-103639-1
13	1.400 [35.56]	1.320 [33.53]	1.200 [30.48]	6-103908-2	6-104909-2	6-103669-2	6-103735-2	6-104910-2	6-103639-2
14	1.500 [38.10]	1.420 [36.07]	1.300 [33.02]	6-103908-3	6-104909-3	6-103669-3	6-103735-3	6-104910-3	6-103639-3
15	1.600 [40.64]	1.520 [38.61]	1.400 [35.56]	6-103908-4	6-104909-4	6-103669-4	6-103735-4	6-104910-4	6-103639-4
16	1.700 [43.18]	1.620 [41.15]	1.500 [38.10]	6-103908-5	6-104909-5	6-103669-5	6-103735-5	6-104910-5	6-103639-5
17	1.800 [45.72]	1.720 [43.69]	1.600 [40.64]	6-103908-6	6-104909-6	6-103669-6	6-103735-6	6-104910-6	6-103639-6
18	1.900 [48.26]	1.820 [46.23]	1.700 [43.18]	6-103908-7	6-104909-7	6-103669-7	6-103735-7	6-104910-7	6-103639-7
19	2.000 [50.80]	1.920 [48.77]	1.800 [45.72]	6-103908-8	6-104909-8	6-103669-8	6-103735-8	6-104910-8	6-103639-8
20	2.100 [53.34]	2.020 [51.31]	1.900 [48.26]	6-103908-9	6-104909-9	6-103669-9	6-103735-9	6-104910-9	6-103639-9
21	2.200 [55.88]	2.120 [53.85]	2.000 [50.80]	7-103908-0	7-104909-0	7-103669-0	7-103735-0	7-104910-0	7-103639-0
22	2.300 [58.42]	2.220 [56.39]	2.100 [53.34]	7-103908-1	7-104909-1	7-103669-1	7-103735-1	7-104910-1	7-103639-1
23	2.400 [60.96]	2.320 [58.93]	2.200 [55.88]	7-103908-2	7-104909-2	7-103669-2	7-103735-2	7-104910-2	7-103639-2
24	2.500 [63.50]	2.420 [61.47]	2.300 [58.42]	7-103908-3	7-104909-3	7-103669-3	7-103735-3	7-104910-3	7-103639-3
25	2.600 [66.04]	2.520 [64.01]	2.400 [60.96]	7-103908-4	7-104909-4	7-103669-4	7-103735-4	7-104910-4	7-103639-4

Notes: 1. Selectively loaded headers are available, consult Tyco Electronics.
 2. Use Keying Tool No. 91417-1 to remove post for keying.

Note: All part numbers are RoHS compliant.

MTE Headers, Shrouded Latching, Single-Row .100 [2.54] Centerline

.025 [0.64] Square Right-Angle Post



Material and Finish

Housing — Black thermoplastic, 94V-0 rated

Posts — Brass, plated as follows:

Plating A — Duplex plated .000030 [0.00076] gold on contact area, .000100 [0.00254] min. tin on solder area, with entire post underplated .000050 [0.00127] nickel

Plating B — Duplex plated .000015 [0.00038] gold on contact area, .000100 [0.00254] min. tin on solder area, with entire post underplated .000050 [0.00127] nickel

Plating C — .000100 [0.00254] tin over .000050 [0.00127] nickel on entire post

With Holddown

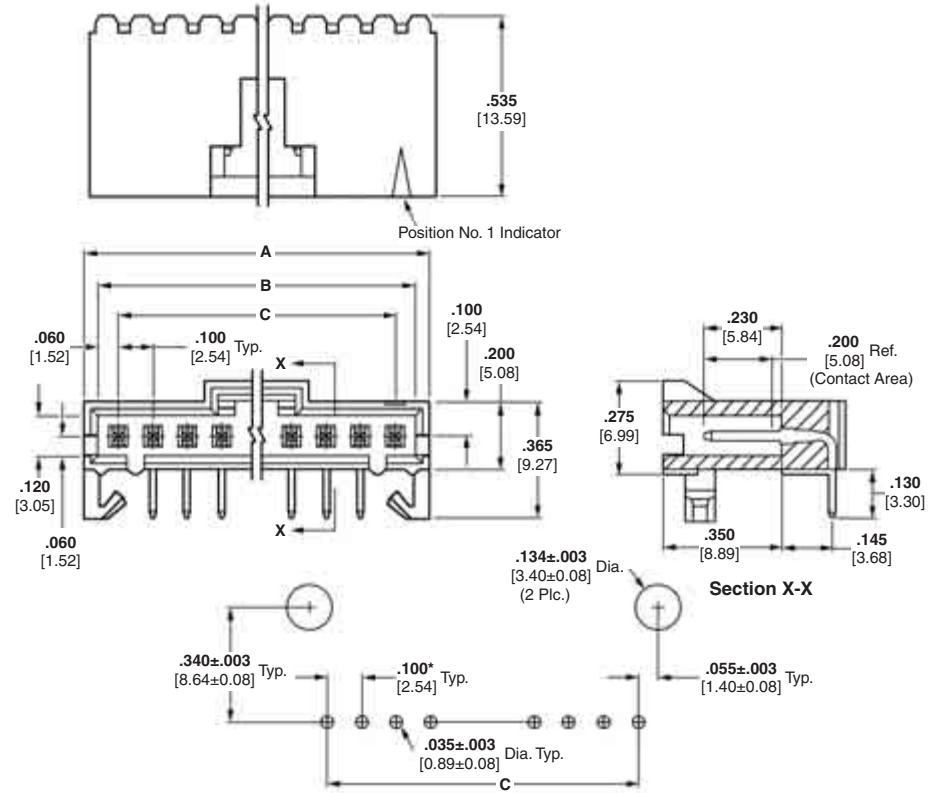

Recommended PC Board Hole Layout (PC board thickness for Holddown Feature) is .062±.008 [1.57±0.20] *±.003 [±0.08]; tolerance not to accumulate within one connector pattern.

Without Holddown

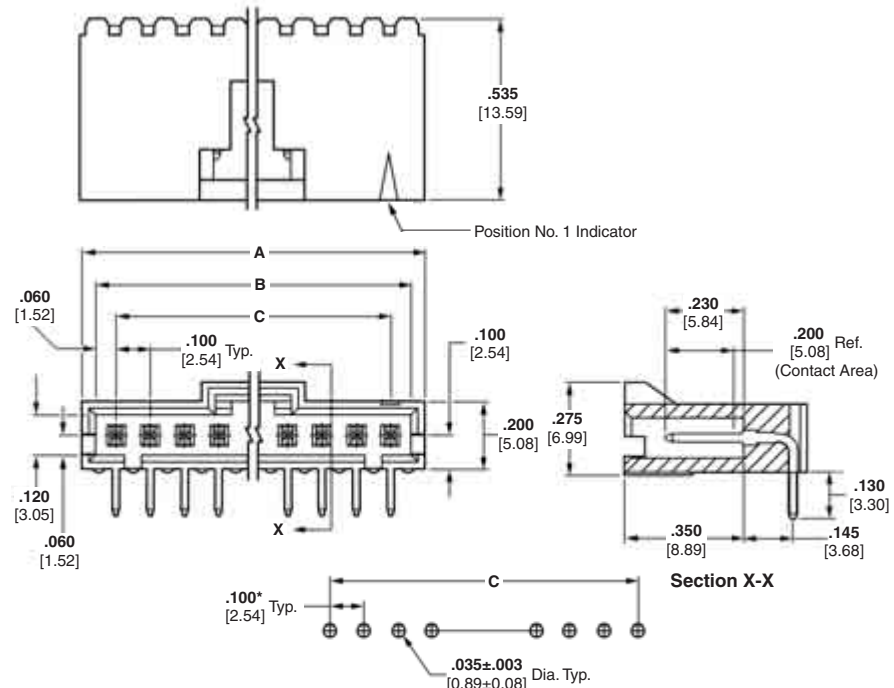

Recommended PC Board Hole Layout *±.003 [±0.08]; tolerance not to accumulate within one connector pattern.

Related Product Data

Mateable AMPMODU MTE Products —

Receptacle Assemblies (Latching) — pages 230, 231
Receptacle Assemblies with Guide Ribs (installed in Single-Row Coupling Shroud) — pages 232, 233, 235, 240

Technical Documents — pages 277, 278

Product Specification 108-25034

Application Specification 114-25026



MTE Headers

5

MTE Headers, Shrouded Latching, Single-Row .100 [2.54] Centerline (Continued)

No. of Pos.	Dimensions			Latching Header With Hold Down			Latching Header Without Hold Down		
	A	B	C	Plating A	Plating B	Plating C	Plating A	Plating B	Plating C
2	.300 [7.62]	.220 [5.59]	.100 [2.54]	5-103904-1	5-103673-1	5-103672-1	5-104935-5	5-103635-1	5-103634-1
3	.400 [10.16]	.320 [8.13]	.200 [5.08]	5-103904-2	5-103673-2	5-103672-2	5-104935-3	5-103635-2	5-103634-2
4	.500 [12.70]	.420 [10.67]	.300 [7.62]	5-103904-3	5-103673-3	5-103672-3	5-104935-1	5-103635-3	5-103634-3
5	.600 [15.24]	.520 [13.21]	.400 [10.16]	5-103904-4	5-103673-4	5-103672-4	5-104935-6	5-103635-4	5-103634-4
6	.700 [17.78]	.620 [15.75]	.500 [12.70]	5-103904-5	5-103673-5	5-103672-5	5-104935-7	5-103635-5	5-103634-5
7	.800 [20.32]	.720 [18.29]	.600 [15.24]	5-103904-6	5-103673-6	5-103672-6	5-104935-8	5-103635-6	5-103634-6
8	.900 [22.86]	.820 [20.83]	.700 [17.78]	5-103904-7	5-103673-7	5-103672-7	5-104935-2	5-103635-7	5-103634-7
9	1.000 [25.40]	.920 [23.37]	.800 [20.32]	5-103904-8	5-103673-8	5-103672-8	5-104935-9	5-103635-8	5-103634-8
10	1.100 [27.94]	1.020 [25.91]	.900 [22.86]	5-103904-9	5-103673-9	5-103672-9	6-104935-0	5-103635-9	5-103634-9
11	1.200 [30.48]	1.120 [28.45]	1.000 [25.40]	6-103904-0	6-103673-0	6-103672-0	6-104935-1	6-103635-0	6-103634-0
12	1.300 [33.02]	1.220 [30.99]	1.100 [27.94]	6-103904-1	6-103673-1	6-103672-1	5-104935-4	6-103635-1	6-103634-1
13	1.400 [35.56]	1.320 [33.53]	1.200 [30.48]	6-103904-2	6-103673-2	6-103672-2	6-104935-2	6-103635-2	6-103634-2
14	1.500 [38.10]	1.420 [36.07]	1.300 [33.02]	6-103904-3	6-103673-3	6-103672-3	6-104935-3	6-103635-3	6-103634-3
15	1.600 [40.64]	1.520 [38.61]	1.400 [35.56]	6-103904-4	6-103673-4	6-103672-4	6-104935-4	6-103635-4	6-103634-4
16	1.700 [43.18]	1.620 [41.15]	1.500 [38.10]	6-103904-5	6-103673-5	6-103672-5	6-104935-5	6-103635-5	6-103634-5
17	1.800 [45.72]	1.720 [43.69]	1.600 [40.64]	6-103904-6	6-103673-6	6-103672-6	6-104935-6	6-103635-6	6-103634-6
18	1.900 [48.26]	1.820 [46.23]	1.700 [43.18]	6-103904-7	6-103673-7	6-103672-7	6-104935-7	6-103635-7	6-103634-7
19	2.000 [50.80]	1.920 [48.77]	1.800 [45.72]	6-103904-8	6-103673-8	6-103672-8	6-104935-8	6-103635-8	6-103634-8
20	2.100 [53.34]	2.020 [51.31]	1.900 [48.26]	6-103904-9	6-103673-9	6-103672-9	6-104935-9	6-103635-9	6-103634-9
21	2.200 [55.88]	2.120 [53.85]	2.000 [50.80]	7-103904-0	7-103673-0	7-103672-0	7-104935-0	7-103635-0	7-103634-0
22	2.300 [58.42]	2.220 [56.39]	2.100 [53.34]	7-103904-1	7-103673-1	7-103672-1	7-104935-1	7-103635-1	7-103634-1
23	2.400 [60.96]	2.320 [58.93]	2.200 [55.88]	7-103904-2	7-103673-2	7-103672-2	7-104935-2	7-103635-2	7-103634-2
24	2.500 [63.50]	2.420 [61.47]	2.300 [58.42]	7-103904-3	7-103673-3	7-103672-3	7-104935-3	7-103635-3	7-103634-3
25	2.600 [66.04]	2.520 [64.01]	2.400 [60.96]	7-103904-4	7-103673-4	7-103672-4	7-104935-4	7-103635-4	7-103634-4

Notes: 1. Selectively loaded headers are available, consult Tyco Electronics.
 2. Use Keying Tool No. 91417-1 to remove post for keying.

Note: All part numbers are RoHS compliant.

MTE Headers, Shrouded Latching, Single-Row .100 [2.54] Centerline

.025 [0.64] Square Straight Post (With Swaged Tails and PC Board Orientation)

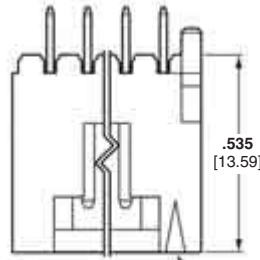

Swaged Retention Tail (See Note)

Position No. 1 Indicator

Material and Finish

Housing — Black thermoplastic, 94V-0 rated

Posts — Brass, plated .000100 [0.00254] tin over .000050 [0.00127] nickel on entire post

Related Product Data

Mateable AMPMODU MTE Products —

Receptacle Assemblies (Polarized/Latching) — pages 230, 231

Receptacle Assemblies with Guide Ribs (installed in Single-Row Coupling Shroud) — pages 232, 233, 235, 240

Technical Documents — pages 277, 278

Product Specification 108-25034

Application Specification 114-25026

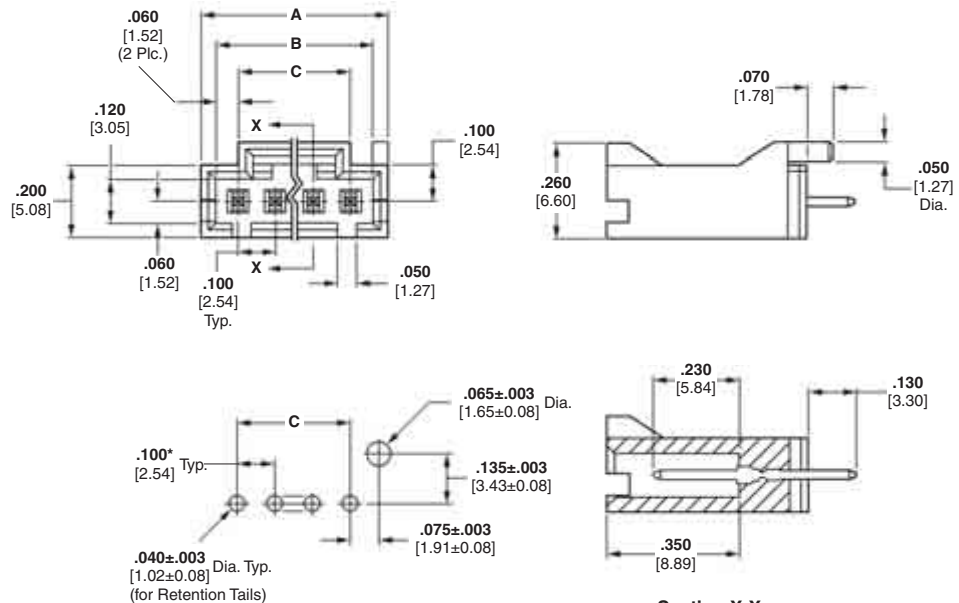

Recommended PC Board Hole Layout

*±.003 [±0.08]; tolerances not to accumulate within one connector pattern.

Note: Swaged retention tails are provided in a minimum of two locations per header.

No. of Pos.	Dimensions			Latching Header
	A	B	C	
2	.300 [7.62]	.220 [5.59]	.100 [2.54]	5-104450-1
3	.400 [10.16]	.320 [8.13]	.200 [5.08]	5-104450-2
4	.500 [12.70]	.420 [10.67]	.300 [7.62]	5-104450-3
5	.600 [15.24]	.520 [13.21]	.400 [10.16]	5-104450-4
6	.700 [17.78]	.620 [15.75]	.500 [12.70]	5-104450-5
7	.800 [20.32]	.720 [18.29]	.600 [15.24]	5-104450-6
8	.900 [22.86]	.820 [20.83]	.700 [17.78]	5-104450-7
9	1.000 [25.40]	.920 [23.37]	.800 [20.32]	5-104450-8
10	1.100 [27.94]	1.020 [25.91]	.900 [22.86]	5-104450-9

Note: All part numbers are RoHS compliant.

MTE Headers, Through-hole, Surface Mount Compatible, Shrouded Polarized/Latching, Single-Row .100 [2.54] Centerline

.025 [0.64] Square Straight Post (With Swaged Tails and PC Board Orientation)



Material and Finish

Housing — Black thermoplastic, 94V-0 rated

Posts — Brass, duplex plated .000015 [0.00038] gold on contact area, .000100 [0.00254] min tin on solder tail, with entire post underplated .000050 [0.00127] nickel

Related Product Data

Mateable AMPMODU MTE Products —

Receptacle Assemblies with Guide Ribs (installed in Single-Row Coupling Shroud) — pages 232, 233, 235, 240

Receptacle Assemblies (Polarized Latching) — pages 230, 231

Technical Documents — pages 277, 278

Product Specification 108-25034

Application Specification 114-25026

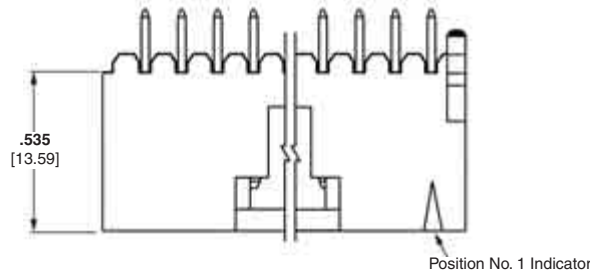

Swaged Retention Tail (See Note)

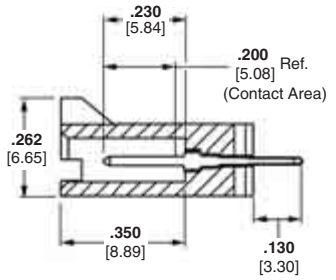
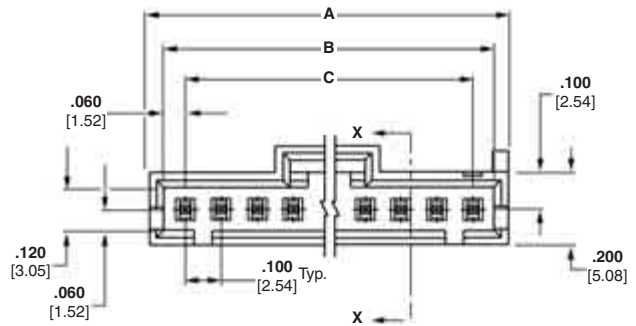

Section X-X

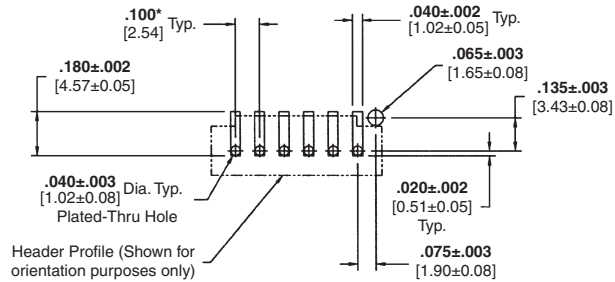

Recommended PC Board Hole Layout (Stencil Thickness = .010 [0.25])

*±.003 [±0.08] tolerance not to accumulate within one connector pattern

No. of Pos.	Dimensions			Polarized/Latching Header, High-Temp
	A	B	C	
2	.300 [7.62]	.220 [5.59]	.100 [2.54]	5-104809-1
3	.400 [10.16]	.320 [8.13]	.200 [5.08]	5-104809-2
4	.500 [12.70]	.420 [10.67]	.300 [7.62]	5-104809-3
5	.600 [15.24]	.520 [13.21]	.400 [10.16]	5-104809-4
6	.700 [17.78]	.620 [15.75]	.500 [12.70]	5-104809-5
7	.800 [20.32]	.720 [18.29]	.600 [15.24]	5-104809-6
8	.900 [22.86]	.820 [20.83]	.700 [17.78]	5-104809-7
9	1.000 [25.40]	.920 [23.37]	.800 [20.32]	5-104809-8
10	1.100 [27.94]	1.020 [25.91]	.900 [22.86]	5-104809-9
11	1.200 [30.48]	1.120 [28.45]	1.000 [25.40]	6-104809-0
12	1.300 [33.02]	1.220 [30.99]	1.100 [27.94]	6-104809-1

Note: All part numbers are RoHS compliant.

MTE Headers, Polarized/Latching, Through-Hole, Surface Mount Compatible, Single-Row, .100 [2.54] Centerline

.025 [0.64] Square Right-Angle Post (With Holddown)



Material and Finish

Housing — Black thermoplastic, 94V-0 rated

Posts — Brass, duplex plated .000015 [0.00038] gold on contact area, .000100 [0.00254] min. tin on solder tail, with entire post underplated .000050 [0.00127] nickel

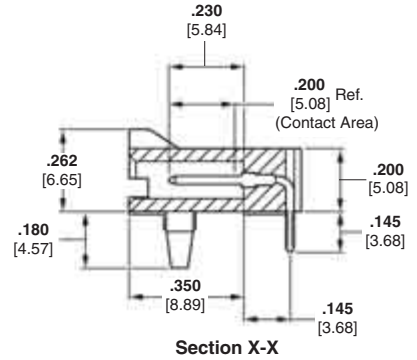
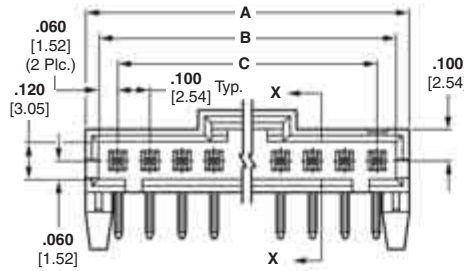
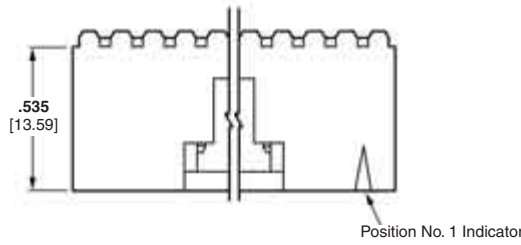

Related Product Data

Mateable AMPMODU MTE Products —

Receptacle Assemblies (Polarized/Latching) — pages 230, 231

Receptacle Assemblies with Guide Ribs (installed in Single-Row Coupling Shroud) — pages 232, 233, 235, 240

Technical Documents — pages 277, 278

Product Specification 108-25034

Application Specification 114-25026

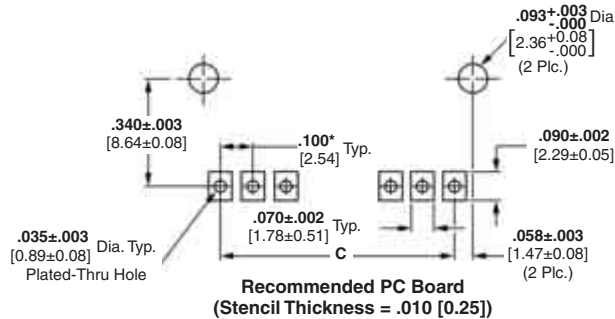

*±.003 [±0.08]; tolerance is not to accumulate within one connector pattern.

No. of Pos.	Dimensions			Right-Angle Header with Hold Down
	A	B	C	
2	.300 [7.62]	.220 [5.59]	.100 [2.54]	5-104361-1
3	.400 [10.16]	.320 [8.13]	.200 [5.08]	5-104361-2
4	.500 [12.70]	.420 [10.67]	.300 [7.62]	5-104361-3
5	.600 [15.24]	.520 [13.21]	.400 [10.16]	5-104361-4
6	.700 [17.78]	.620 [15.75]	.500 [12.70]	5-104361-5
7	.800 [20.32]	.720 [18.29]	.600 [15.24]	5-104361-6
8	.900 [22.86]	.820 [20.83]	.700 [17.78]	5-104361-7
9	1.000 [25.40]	.920 [23.37]	.800 [20.32]	5-104361-8
10	1.100 [27.94]	1.020 [25.91]	.900 [22.86]	5-104361-9
11	1.200 [30.48]	1.120 [28.44]	1.000 [25.40]	6-104361-0
12	1.300 [33.02]	1.220 [30.99]	1.100 [27.94]	6-104361-1
13	1.400 [35.56]	1.320 [33.53]	1.200 [30.48]	6-104361-2

No. of Pos.	Dimensions			Right-Angle Header with Hold Down
	A	B	C	
14	1.500 [38.10]	1.420 [36.07]	1.300 [33.02]	6-104361-3
15	1.600 [40.64]	1.520 [38.61]	1.400 [35.56]	6-104361-4
16	1.700 [43.18]	1.620 [41.15]	1.500 [38.10]	6-104361-5
17	1.800 [45.72]	1.720 [43.69]	1.600 [40.64]	6-104361-6
18	1.900 [48.26]	1.820 [46.23]	1.700 [43.18]	6-104361-7
19	2.000 [50.80]	1.920 [48.77]	1.800 [45.72]	6-104361-8
20	2.100 [53.34]	2.020 [51.31]	1.900 [48.26]	6-104361-9
21	2.200 [55.88]	2.120 [53.85]	2.000 [50.80]	7-104361-0
22	2.300 [58.42]	2.220 [56.39]	2.100 [53.34]	7-104361-1
23	2.400 [60.96]	2.320 [58.93]	2.200 [55.88]	7-104361-2
24	2.500 [63.50]	2.420 [61.47]	2.300 [58.42]	7-104361-3
25	2.600 [66.04]	2.520 [64.01]	2.400 [60.96]	7-104361-4

Note: All part numbers are RoHS compliant.

MTE Headers, Right-Angle, Polarized/Latching, Surface Mount

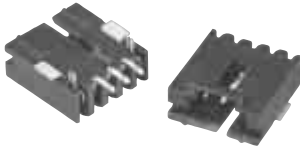

Material and Finish

Housing — Black thermoplastic, 94V-0 rated

Posts — Brass, plated as follows:

Plating A — Duplex plated .000030 [.00076] gold on contact area, .000100 [.00254] min. tin on solder area, with entire post underplated .000050 [.00127] nickel.

Plating B — Duplex plated .000015 [.00038] gold on contact area, .000100 [.00254] min. tin on solder area, with entire post underplated .000050 [.00127] nickel.

Plating C — .000100 [.00254] tin over .000050 [.00127] nickel on entire post

Recommended PC Board Layout

(Refer to MTE Application Spec. 114-25026 for Stencil Aperture Layout Using .006 [0.152] or .008 [0.203] Stencil Thickness)

Related Product Data

Mateable AMPMODU MTE Products —

Receptacle Assemblies (Polarized/Latching) — pages 230, 231

Receptacle Assemblies with Guide Ribs (installed in Single-Row Coupling Shroud) — pages 232, 233, 235, 240

Technical Documents — pages 277, 278

Product Specification 108-25034

Application Specification 114-25026

Note: All part numbers are RoHS compliant.

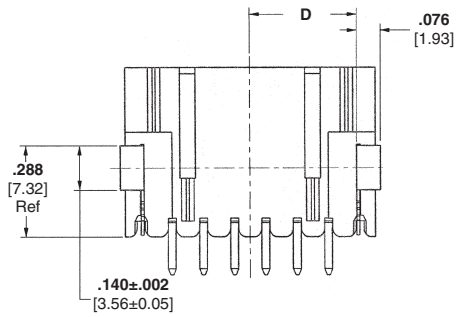
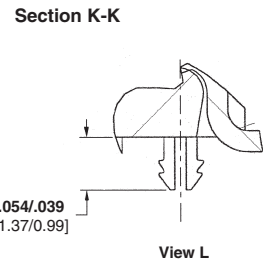
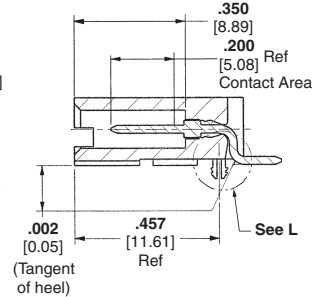
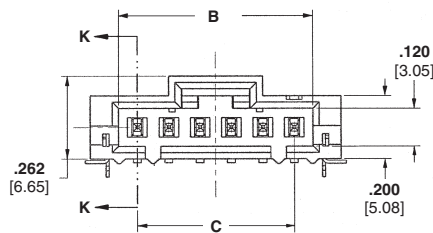
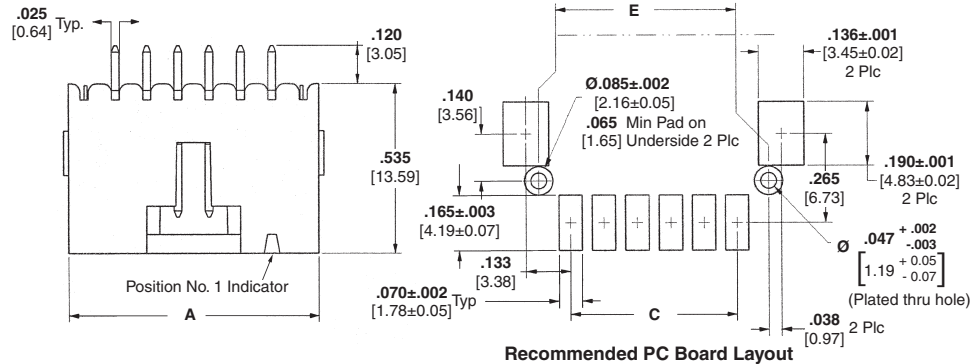

No. of Pos.	Dimensions					Right-Angle Latching SMT Headers		
	A	B	C	D	E	Plating A	Plating B	Plating C
2	.400 [10.16]	.220 [5.59]	.100 [2.54]	.140 [3.56]	.290 [7.37]	5-147323-1	5-147278-1	5-147324-1
3	.500 [12.70]	.320 [8.13]	.200 [5.08]	.190 [4.83]	.390 [9.91]	5-147323-2	5-147278-2	5-147324-2
4	.600 [15.24]	.420 [10.67]	.300 [7.62]	.240 [6.10]	.490 [12.45]	5-147323-3	5-147278-3	5-147324-3
5	.700 [17.78]	.520 [13.21]	.400 [10.16]	.290 [7.37]	.590 [14.99]	5-147323-4	5-147278-4	5-147324-4
6	.800 [20.32]	.620 [15.75]	.500 [12.70]	.340 [8.64]	.690 [17.53]	5-147323-5	5-147278-5	5-147324-5
7	.900 [22.86]	.720 [18.29]	.600 [15.24]	.390 [9.91]	.790 [20.07]	5-147323-6	5-147278-6	5-147324-6
8	1.000 [25.40]	.820 [20.83]	.700 [17.78]	.440 [11.18]	.890 [22.61]	5-147323-7	5-147278-7	5-147324-7
9	1.100 [27.94]	.920 [23.37]	.800 [20.32]	.490 [12.45]	.990 [25.15]	5-147323-8	5-147278-8	5-147324-8
10	1.200 [30.48]	1.020 [25.91]	.900 [22.86]	.540 [13.72]	1.090 [27.69]	5-147323-9	5-147278-9	5-147324-9
11	1.300 [33.02]	1.120 [28.45]	1.000 [25.40]	.590 [14.99]	1.190 [30.23]	6-147323-0	6-147278-0	6-147324-0
12	1.400 [35.56]	1.220 [30.99]	1.100 [27.94]	.640 [16.26]	1.290 [32.77]	6-147323-1	6-147278-1	6-147324-1
13	1.500 [38.10]	1.320 [33.53]	1.200 [30.48]	.690 [17.53]	1.390 [35.31]	6-147323-2	6-147278-2	6-147324-2
14	1.600 [40.64]	1.420 [36.07]	1.300 [33.02]	.740 [18.80]	1.490 [37.85]	6-147323-3	6-147278-3	6-147324-3
15	1.700 [43.18]	1.520 [38.61]	1.400 [35.56]	.790 [20.07]	1.590 [40.39]	6-147323-4	6-147278-4	6-147324-4
16	1.800 [45.72]	1.620 [41.15]	1.500 [38.10]	.840 [21.34]	1.690 [42.93]	6-147323-5	6-147278-5	6-147324-5
17	1.900 [48.26]	1.720 [43.69]	1.600 [40.64]	.890 [22.61]	1.790 [45.47]	6-147323-6	6-147278-6	6-147324-6
18	2.000 [50.80]	1.820 [46.23]	1.700 [43.18]	.940 [23.88]	1.890 [48.01]	6-147323-7	6-147278-7	6-147324-7
19	2.100 [53.34]	1.920 [48.77]	1.800 [45.72]	.990 [25.15]	1.990 [50.55]	6-147323-8	6-147278-8	6-147324-8
20	2.200 [55.88]	2.020 [51.31]	1.900 [48.26]	1.040 [26.42]	2.090 [53.09]	6-147323-9	6-147278-9	6-147324-9
21	2.300 [58.42]	2.120 [53.85]	2.000 [50.80]	1.090 [27.69]	2.190 [55.63]	7-147323-0	7-147278-0	7-147324-0
22	2.400 [60.96]	2.220 [56.39]	2.100 [53.34]	1.140 [28.96]	2.290 [58.17]	7-147323-1	7-147278-1	7-147324-1
23	2.500 [63.50]	2.320 [58.93]	2.200 [55.88]	1.190 [30.23]	2.390 [60.71]	7-147323-2	7-147278-2	7-147324-2
24	2.600 [66.04]	2.420 [61.47]	2.300 [58.42]	1.240 [31.50]	2.490 [63.25]	7-147323-3	7-147278-3	7-147324-3
25	2.700 [68.58]	2.520 [64.01]	2.400 [60.96]	1.290 [32.77]	2.590 [65.79]	7-147323-4	7-147278-4	7-147324-4

MTE Headers, Vertical, Polarized/Latching, Surface Mount

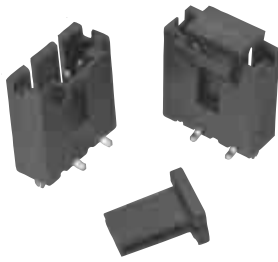

Material and Finish

Housing — Black thermoplastic, 94V-0 rated

Posts — Brass, plated as follows:

Plating A — Duplex plated .000030 [.00076] gold on contact area, .000100 [.00254] min. tin on solder area, with entire post underplated .000050 [.00127] nickel.

Plating B — Duplex plated .000015 [.00038] gold on contact area, .000100 [.00254] min. tin on solder area, with entire post underplated .000050 [.00127] nickel.

Plating C — .000100 [.00254] tin over .000050 [.00127] nickel on entire post

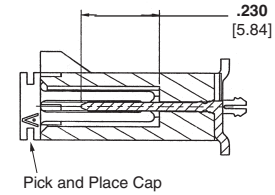
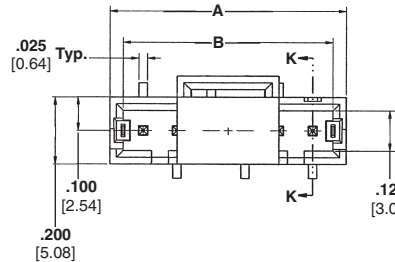
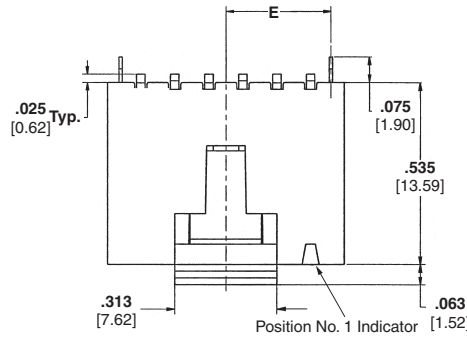

Section K-K

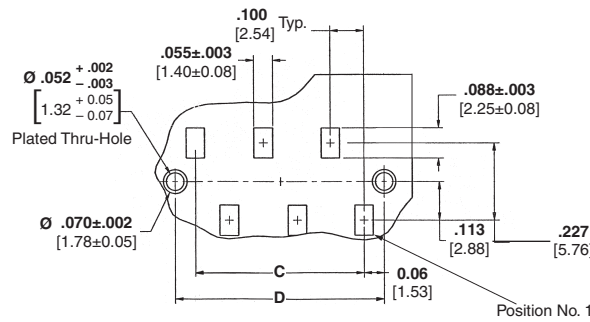

Recommended PC Board Layout

Recommended PC Board Layout

(Refer to MTE Application Spec. 114-25026 for Stencil Aperture Layout using .006 [0.152] or .008 [0.203] stencil thickness

Related Product Data

Mateable AMPMODU MTE Products —

Receptacle Assemblies (Polarized/Latching) — pages 230, 231

Receptacle Assemblies with Guide Ribs (installed in Single-Row Coupling Shroud) — pages 232, 233, 235, 240

Technical Documents — pages 277, 278

Product Specification 108-25034

Application Specification 114-25026

No. of Pos.	Dimensions					Vertical SMT Headers		
	A	B	C	D	E	Plating A	Plating B	Plating C
2	.300[7.62]	.220[5.59]	.100[2.54]	.220[5.60]	.110[2.80]	5-1375583-1	5-1375582-1	5-1375549-1
3	.400[10.16]	.320[8.13]	.200[5.08]	.320[8.14]	.160[4.07]	5-1375583-2	5-1375582-2	5-1375549-2
4	.500[12.70]	.420[10.67]	.300[7.62]	.420[10.68]	.210[5.34]	5-1375583-3	5-1375582-3	5-1375549-3
5	.600[15.24]	.520[13.21]	.400[10.16]	.520[13.22]	.260[6.61]	5-1375583-4	5-1375582-4	5-1375549-4
6	.700[17.78]	.620[15.75]	.500[12.70]	.620[15.76]	.310[7.88]	5-1375583-5	5-1375582-5	5-1375549-5
7	.800[20.32]	.720[18.29]	.600[15.24]	.720[18.30]	.360[9.15]	5-1375583-6	5-1375582-6	5-1375549-6
8	.900[22.86]	.820[20.83]	.700[17.78]	.820[20.84]	.410[10.42]	5-1375583-7	5-1375582-7	5-1375549-7
9	1.000[25.40]	.920[23.37]	.800[20.32]	.920[23.38]	.460[11.69]	5-1375583-8	5-1375582-8	5-1375549-8
10	1.100[27.94]	1.020[25.91]	.900[22.86]	1.020[25.92]	.510[12.96]	5-1375583-9	5-1375582-9	5-1375549-9
11	1.200[30.48]	1.120[28.45]	1.000[25.40]	1.120[28.46]	.560[14.23]	6-1375583-0	6-1375582-0	6-1375549-0
12	1.300[33.02]	1.220[30.99]	1.100[27.94]	1.220[31.00]	.610[15.50]	6-1375583-1	6-1375582-1	6-1375549-1
13	1.400[35.56]	1.320[33.53]	1.200[30.48]	1.320[33.54]	.660[16.77]	6-1375583-2	6-1375582-2	6-1375549-2
14	1.500[38.10]	1.420[36.07]	1.300[33.02]	1.420[36.08]	.710[18.04]	6-1375583-3	6-1375582-3	6-1375549-3
15	1.600[40.64]	1.520[38.61]	1.400[35.56]	1.520[38.62]	.760[19.31]	6-1375583-4	6-1375582-4	6-1375549-4
16	1.700[43.18]	1.620[41.15]	1.500[38.10]	1.620[41.16]	.810[20.58]	6-1375583-5	6-1375582-5	6-1375549-5
17	1.800[45.72]	1.720[43.69]	1.600[40.64]	1.720[43.70]	.860[21.85]	6-1375583-6	6-1375582-6	6-1375549-6
18	1.900[48.26]	1.820[46.23]	1.700[43.18]	1.820[46.24]	.910[23.12]	6-1375583-7	6-1375582-7	6-1375549-7
19	2.000[50.80]	1.920[48.77]	1.800[45.72]	1.920[48.78]	.960[24.39]	6-1375583-8	6-1375582-8	6-1375549-8
20	2.100[53.34]	2.020[51.31]	1.900[48.26]	2.020[51.32]	1.010[25.66]	6-1375583-9	6-1375582-9	6-1375549-9
21	2.200[55.88]	2.120[53.85]	2.000[50.80]	2.120[53.86]	1.060[26.93]	7-1375583-0	7-1375582-0	7-1375549-0
22	2.300[58.42]	2.220[56.39]	2.100[53.34]	2.220[56.40]	1.110[28.20]	7-1375583-1	7-1375582-1	7-1375549-1
23	2.400[60.96]	2.320[58.93]	2.200[55.88]	2.320[58.94]	1.160[29.47]	7-1375583-2	7-1375582-2	7-1375549-2
24	2.500[63.50]	2.420[61.47]	2.300[58.42]	2.420[61.48]	1.210[30.74]	7-1375583-3	7-1375582-3	7-1375549-3
25	2.600[66.04]	2.520[64.01]	2.400[60.96]	2.520[64.02]	1.260[32.01]	7-1375583-4	7-1375582-4	7-1375549-4

Note: All part numbers are RoHS compliant.

Interchangeable Contacts, Wire Crimp (Snap-In)

Material and Finish

Copper alloy C7025, plated as follows:

Plating A — Duplex plated .000030 [0.00076] min. gold on contact area, .000050 [0.00127] min. tin in crimp area, with entire contact underplated .000050 [0.00127] min. nickel

Plating B — Duplex plated .000015 [0.00038] min. gold on contact area, .000050 [0.00127] min. tin in crimp area, with entire contact underplated .000050 [0.00127] min. nickel

Plating C — .000100 [0.00254] min. tin over .000050 [0.00127] min. nickel on entire contact



Keying Plug

Part No. 104072-1

Ten plugs are supplied per strip. Order quantity reflects the number of strips required.



**Extraction/Lance Reset
Tool No. 843477-1**

Short Point Receptacles

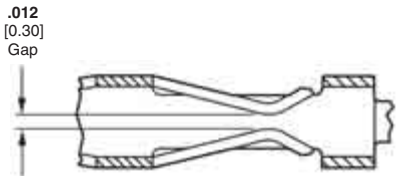
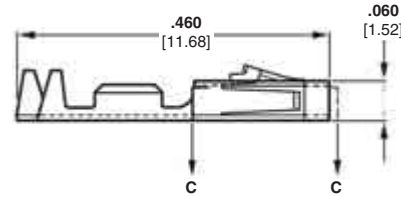
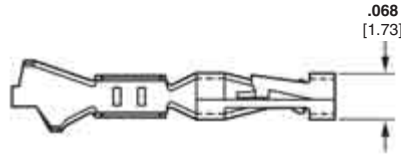

Section C - C

Related Product Data

Performance Characteristics — page 221

Housings used in — Short Point—pages 223, 224

AMPMODU MTE Unloaded Housings — pages 228-233

Application Tooling— pages 270-272

Technical Documents — pages 277, 278

Product Specification
108-1472, 108-1472-1

Application Specification
114-25038

Wire Size Range AWG [mm ²]	Ins. Dia. Range	Finish	Contact Part No. (Standard Pressure)		Heavy Duty Miniature Applicator for AMP-O-ELECTRIC Machine*	Applicator for AMP-O-MATIC Stripper/Crimper Machine	Hand Tool Nos.
			Strip Form	Loose Piece			
32-28 0.03-0.08	.025-.060 0.64-1.52	Plating A	1-104481-1	1-104481-3	567296-2	466980-1	91518-1
		Plating B	1-104481-0	1-104481-2			
		Plating C	5-104481-2	5-104481-6			
26-22 0.13-0.3	.025-.060 0.64-1.52	Plating A	1-104480-3	1-104480-6	567297-2	466981-1	91518-1
		Plating B	1-104480-2	1-104480-5			
		Plating C	1-104480-7	1-104480-4			
24-20 0.2-0.5	.025-.060 0.64-1.52	Plating A	1-104479-0	1-104479-3	567298-2	466982-1	91551-1
		Plating B	1-104479-9	1-104479-2			
		Plating C	1-104479-8	1-104479-1			

*For use with Model "K" machines. Call the Technical Support Center (1-800-522-6752) for part nos. of applicators for use with the Model "G" machines (shown on page 270), as well as other bench machines and fully automatic AMPOMATOR lead making machines.

Note: These wire crimp contacts can be intermixed with insulation displacement crimp contacts.

Note: All part numbers are RoHS compliant.

Interchangeable Contacts, Wire Crimp (Snap-In) (Continued)

Material and Finish

Phosphor bronze, plated as follows:

Plating A — Duplex plated .000030 [0.00076] gold on contact area, .000030 [0.00076] min. tin in crimp area, with entire contact underplated .000050 [0.00127] nickel

Plating B — Duplex plated .000015 [0.00038] gold on contact area, .000030 [0.00076] min. tin on solder area, with entire contact underplated .000050 [0.00127] nickel

Plating C — .000100 [0.00254] tin over .000050 [0.00127] nickel on entire contact

Pins

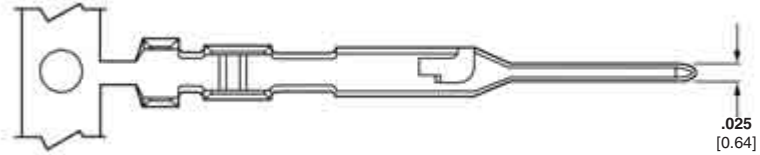

Extraction/Lance Reset Tool No. 843477-1

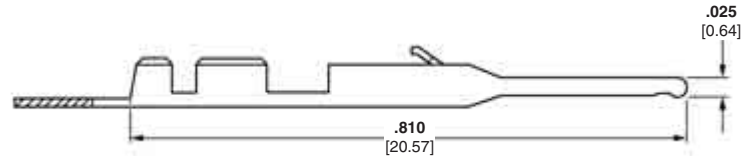

Related Product Data

Performance Characteristics — page 221

AMPMODU MTE Unloaded Housings — pages 228-233

Application Tooling — pages 270-272

Technical Documents — pages 277, 278

Product Specification 108-25034

Application Specification 114-25026

Wire Size Range AWG [mm ²]	Ins. Dia. Range	Finish	Contact Part No. (Standard Pressure)		Heavy Duty Miniature Applicator for AMP-O-LECTRIC Machine*	Applicator for AMP-O-MATIC Stripper/Crimper Machine	Hand Tool Nos.
			Strip Form	Loose Piece			
32-28 0.03-0.08	.025-.054 0.64-1.37	Plating A	5-104506-6	5-104506-7	—	—	58342-2
		Plating B	5-104506-4	5-104506-5			
		Plating C	5-104506-2	5-104506-3			
26-22 0.14-0.32	.036-.054 0.91-1.37	Plating A	5-104505-6	5-104505-7	567239-2	466983-1	91531-1
		Plating B	5-104505-4	5-104505-5			
		Plating C	5-104505-2	5-104505-3			

*For use with AMP-O-LECTRIC Model "K" machines. Call Technical Support Center (1-800-522-6752) for part nos. of applicators for use with the AMP-O-LECTRIC Model "G" machines (shown on page 270), as well as other bench machines and fully automatic AMPOMATOR lead making machines.
Note: These wire crimp contacts can be intermixed with insulation displacement crimp contacts.

Note: All part numbers are RoHS compliant.