

# Amphenol® Low Mating Force Rectangular Connectors

12-035-10

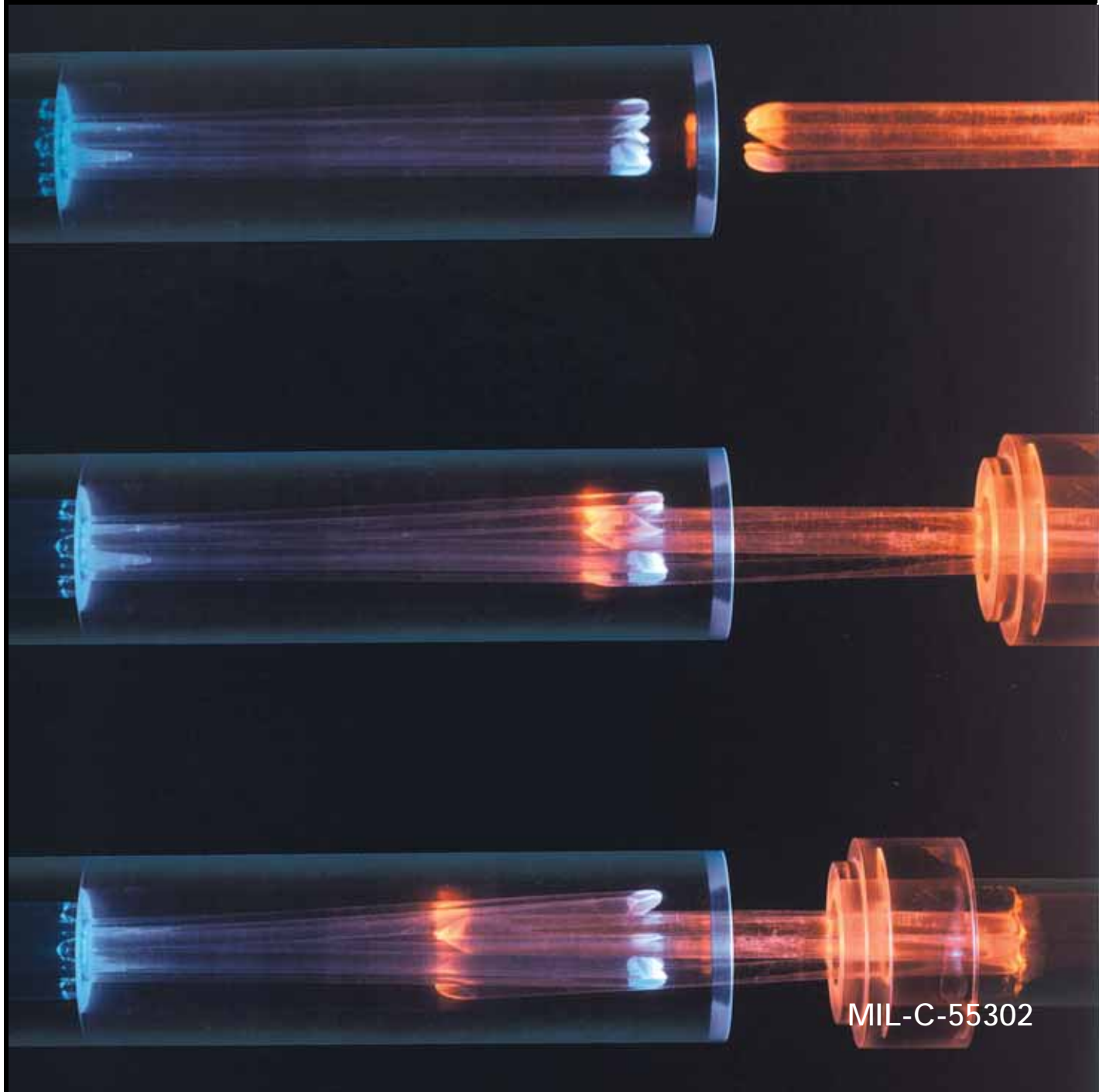

# Amphenol

# Table of Contents

| Page No. | Item  |
|----------|---|
| 1        | The B <sup>3</sup> Contact Innovation                 |
| 2, 3     | Low Mating Force Electrical Connectors                |
| 4        | Low Mating Force Hybrid Configurations                |
| 5 – 8    | How to Order  |
| 8, 9     | Contact Arrangements                                  |
| 10, 11   | Contact Repair/Replacement, Installation Instructions |
| 12 – 15  | Mother Board Connector                                |
| 16 – 19  | Daughter Board Connector                              |
| 20 – 23  | Input/Output Connector                                |
| 24 – 27  | PC Connector  |
| 28       | Accessories, Polarization Keys                        |
| 29       | Accessories, Mounting Applications                    |
| 30       | Accessories, Test Probe Kit                           |
| 31       | LRM Surface Mount Connectors                          |

*Due to space limitations, metric equivalents of dimensional data in this catalog have not been included. All dimensions given may be converted to the metric system by the standard formula: inches x 25.40 = Millimeters.*

If more information is needed concerning the products in this publication, or if you have any special application needs, please contact your nearest Amphenol sales office or Amphenol Corporation at the following address:

Amphenol Corporation  
Amphenol Aerospace  
40-60 Delaware Ave.  
Sidney, NY 13838-1395  
Telephone: 607-563-5011  
Fax: 607-563-5157  
[www.amphenol-aerospace.com](http://www.amphenol-aerospace.com)

NOTE: The connector products in this brochure were formerly known as Bendix® products. These products are now manufactured and sold under the Amphenol® brand name. The name "Amphenol" will replace the name "Bendix" on products and literature in the future.

Amphenol Aerospace is a Certified ISO 9001 Manufacturer.

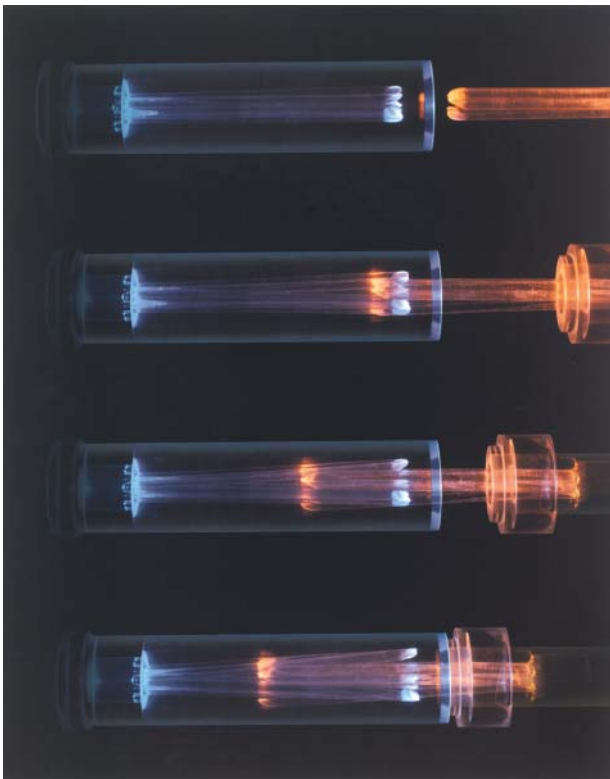

## the B<sup>3</sup> Contact Innovation . . .

The Amphenol® B<sup>3</sup> Contact is an engineered, innovative solution to problems caused by the high mating and unmating forces of conventional pin and socket contact pairs. B<sup>3</sup> stands for Bristle Brush Bunch, a descriptive name for the multiple strands of high tensile strength wire that are bundled together to form the brush-like contact. By intermeshing two multi-strand wire bundles, an electrical connection is made. The B<sup>3</sup> contact design results in low, normal contact site forces and significantly reduces mating and unmating forces.

The B<sup>3</sup> Contact offers:

- low mating/unmating forces
- superior electrical characteristics
- proven durability and long contact life
- a new age of PC design

Applications for Amphenol Connectors with Brush B<sup>3</sup> contacts:

- Medical equipment
- IC chip testers
- Telecommunications
- Military and commercial aviation
- Military ground vehicles
- GPS systems
- Space
- Industrial

# Amphenol® Low Mating Force Rectangular Connectors MIL-C-55302 (M55302/166 thru /172)

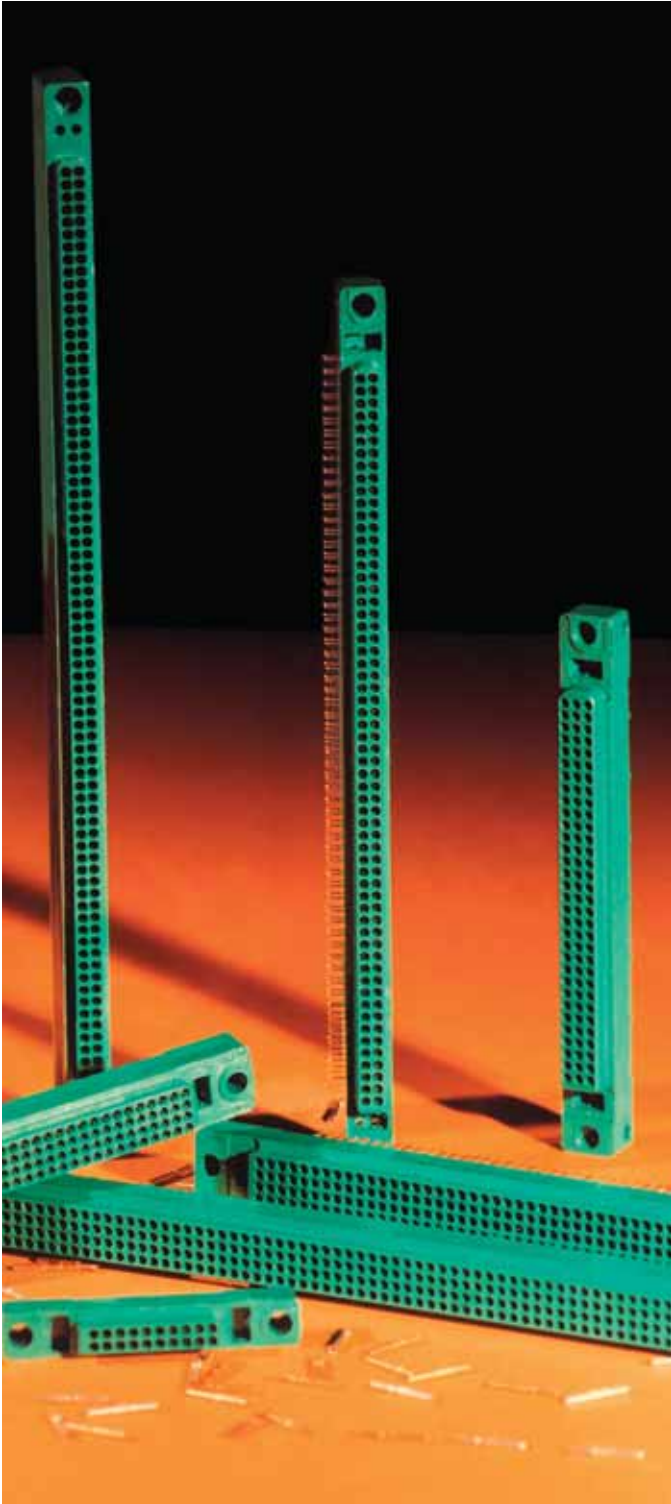

## Featuring the Amphenol® B<sup>3</sup> Bristle® Brush® Contact

- **Low Mating and Unmating Forces**
  - Smooth, low friction interfaces
  - 70% to 90% reduction in mating/unmating forces from conventional pin-socket contacts
  - 1.5 oz. maximum forces per contact pair (one ounce typical)
  - Easy mating/unmating makes high circuit counts practical (25 lbs. typical for 400 contacts)
  - Mechanical mating aids not required
  - No need for external board support structures for connectors up to 7 inches in length. A center support is recommended for Mother Board Connectors over 7 inches
- **Proven durability and long contact life**
  - Over 20,000 cycles of mating and unmating without performance degradation
  - Documented intermittency-free performance – no 10 nano second discontinuities during 50m cycles of 0.010 displacement
  - Overall cost effectiveness (reduced life cycle costs)
- **Multiple points of contact = superior electrical capability**
  - 14-70 points of contact per mated contact
  - Stable, low resistance – 20 milliohms max.
  - Redundant current paths - lower total resistance
  - Proven electrical and gas tight contact sites
- **Key Connector Features**
  - 0.100 inch center to center, square grid contact spacing
  - Four body styles - Mother Board, Daughter Board, PC (also referred to as "right angle Motherboard"), and Input/Output - allows application flexibility (parallel boards, perpendicular boards, wire to board, end to end boards, card extenders)
  - 2, 3 and 4 row contact arrangements with 10 to 100 contacts per row in one contact per row increments
  - Termination versatility: straight & 90° PCB stud, wire wrap and crimp
  - Options on termination length and plating
  - Front release/front removable contacts in Mother Board, Daughter Board and PC versions; rear release/rear removable crimp contacts (size 22D) or printed circuit board pins provided with Input/Output Connector
  - Accessories available for latching and polarization
  - Up to 256 keyed, mating polarizations available
  - Hybrids available – mix signal with power, RF or fiber optics

- **Performance**

- voltage rating:  $\frac{SL}{1300} \frac{70,000 \text{ ft.}}{325}$
- one and one-half ounce max. average contact engaging/separating forces
- 7 milliohm average contact resistance for row A contacts (Resistance will vary depending on the point of measurement and the length of the contact.)
- 3 ampere – PCB contacts
- 5 ampere – wire wrap/crimp contacts
- –65° C to +125° C temperature rating
- 5 gigaohms minimum insulation resistance

- **Materials**

- Connector Body – Glass-filled thermoplastic molding material in accordance with MIL-M-24519 type GPT-15F and/or Grade B, Class 15 of MIL-P-46161 (UL94V-O).
- Polarization Keys – Glass-filled acetal plastic molding material in accordance with MIL-P-46137
- Locking Screw/Mounting Bushing – Corrosion resistant steel AISI 300 types passivated in accordance with QQ-P-35

- **Contacts**

- Holders – Copper alloy in accordance with Federal Specification QQ-B-626 or SAE J463
- Wire – Beryllium copper in accordance with Federal Specification ASTM B197
- Sleeves – If applicable, stainless steel in accordance with AMS-5514 passivated in accordance with ASTM A967

*Upper Right: An Input/Output and Mother Board Connector*

*Lower Left: Unmated Input/Output and PC Connector*

*Lower Right: Mated Mother Board and Daughter Board Connector*

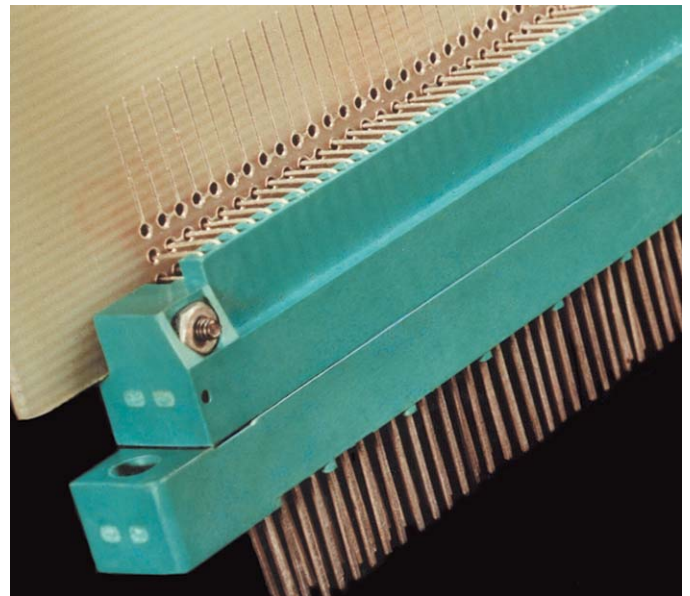
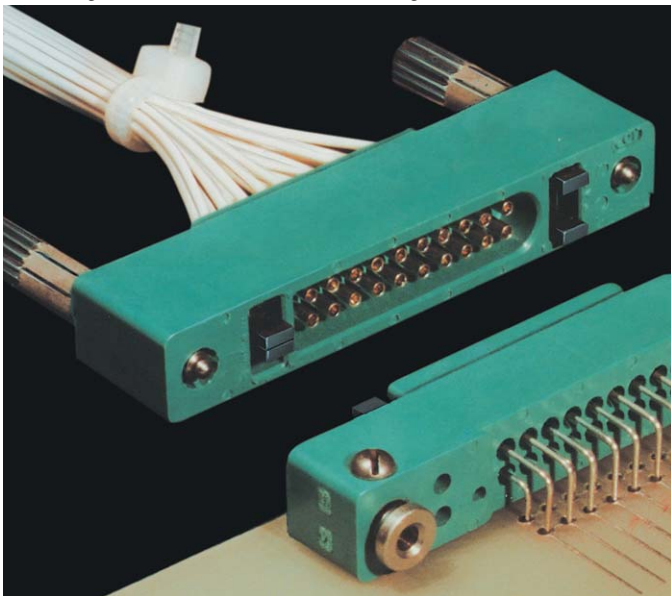

# Low Mating Force hybrid configurations – signal, power, coax or fiber optics

**Power and/or shielded (coax or twinax) contacts are available in combination with Brush signal contacts in one high density (hybrid) connector.**

- Available with 100 brush signal contacts with up to 12 size 16 power or coax contacts in a 2 row connector
- Available with 180 brush signal contacts with up to 12 size 12 power or coax contacts in a 3 row connector
- Use of standard MIL-DTL-38999\*, Series II power and coax contacts

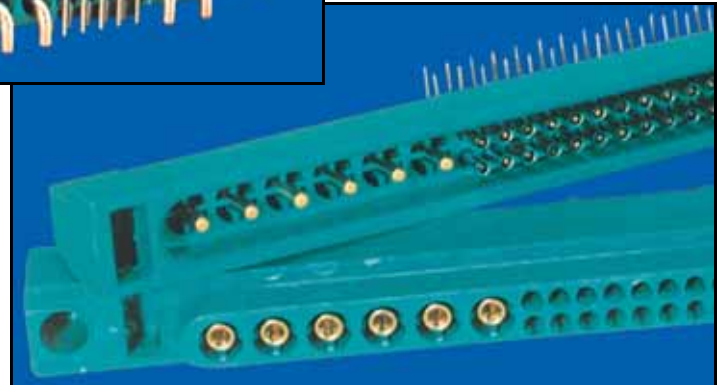

COMBINATION OF BRUSH CONTACTS AND POWER CONTACTS

**Hybrid configurations can be made available with fiber optics and Brush contacts in the same connector.**

Amphenol's superiority and breadth of product offering is demonstrated in its capability for packaging fiber termini and the Brush contact in a printed circuit board rectangular connector. Optical performance, high speed and secure communication are obtained with fiber optic interconnects incorporated into the rectangular housings, along with the low mating force advantages of the brush contact in the same connector.

NOTE: Power and coax contacts and fiber optic termini are not provided with the connector and must be purchased separately.

Consult Amphenol Aerospace, Sidney, NY for assistance in solving design problems and for part numbers that will provide the proper combination of these hybrid configurations to meet your specific connector application requirements.

\* MIL-DTL-38999 supersedes MIL-C-38999.



COMBINATION OF BRUSH CONTACTS AND SHIELDED CONTACTS

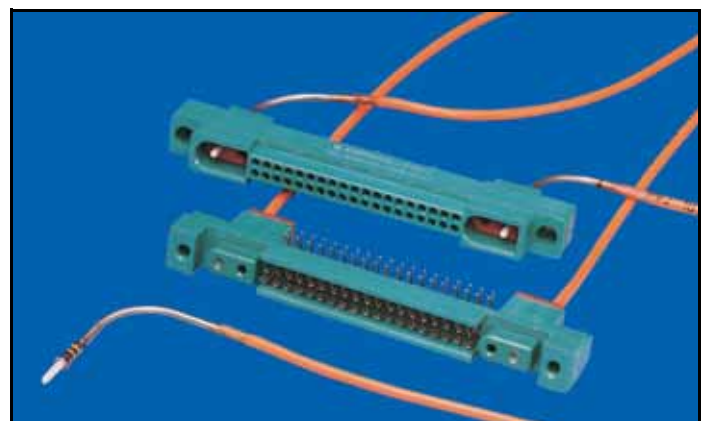

COMBINATION OF BRUSH CONTACTS AND FIBER OPTIC TERMINI

# Low Mating Force

## how to order (military types)

### MB, DB, PC Connectors Military Part Number Ordering Procedure

Example part number M55302/166A10X1 is shown as follows:

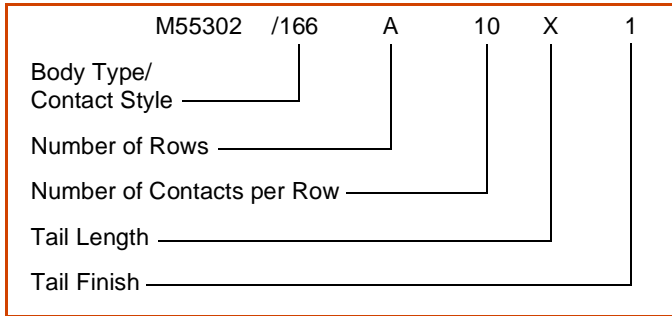

#### Body Type/Contact Style

- /166 designates MB-P (Mother Board, Printed Circuit Board Termination)
- /167 designates MB-W (Mother Board, Wire-wrap Contacts)
- /168 designates PC (Printed Circuit, 90° Printed Circuit Board Termination)
- /170 designates DB (Daughter Board, 90° Printed Circuit Board Termination)

#### Number of Rows

- A – 2 Rows
- B – 3 Rows
- C – 4 Rows

#### Number of Contacts per Row

Contact counts per row range from 10 to 100  
(Only 2 digits permitted in this space; for 100 contacts per row, use 00)

#### Tail Length

| MB-P<br>(PCB Termination)* | MB-W**<br>(Wire-wrap) |
|----------------------------|-----------------------|
| X – .300 ±.025             | Y – .700 ±.025        |
| Y – .145 ±.025             | Z – .542 ±.025        |
| Z – .113 ±.025             |                       |

| DB*            | PC*                     |
|----------------|-------------------------|
| X – .300 ±.025 | Y – .150 +.035<br>-.025 |
| Y – .150 ±.025 | Z – .095 +.035<br>-.025 |
| Z – .120 ±.025 |                         |

\* Reference "J" Dimension on all connector drawings in this catalog.  
\*\* For MB-W only: Reference "H" Dimension on connector drawing on page 12.

#### Tail Finish

- 1 Tin lead per MIL-P-81728, 50 to 70% tin, .0001 min. thick over copper
- 2 Gold per MIL-G-45204, type II, grade C, class 00 (01 for MB-W) over nickel per QQ-N-290

### IO Connectors Military Part Number Ordering Procedure

Example part number M55302/169A101 is shown as follows:

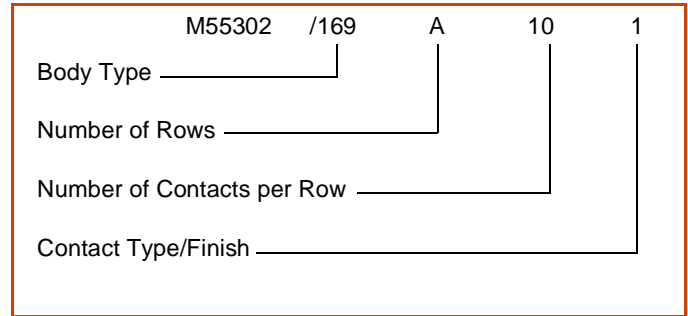

#### Body Type

- /169 designates IO (Input/Output)  
(Contact type/finish is last digit of IO part number - see list of options below)

#### Number of Rows

- A – 2 Rows
- B – 3 Rows
- C – 4 Rows

#### Number of Contacts per Row

Contact counts per row range from 10 to 100  
(Only 2 digits permitted in this space; for 100 contacts per row, use 00)

#### Contact Type/Finish

- 1 Crimp contact – Tin lead per MIL-P-81728, 50 to 70% tin, .0001 min. thick over copper
- 2 Crimp contact – Gold per MIL-G-45204, type II, grade C, class 1 over copper
- 3 Connectors supplied less contacts
- 4 PCB contacts installed with .145 ±.025 stickout – Tin lead per MIL-P-81728, 50 to 70% tin, .0001 min. thick over copper (Reference "J" Dimension on connector drawing on page 20).

#### To Order IO Contacts

(For use with connectors less contacts)

M55302/171-1

\_\_\_\_\_ suffix designates crimp well finish

#### Crimp well finish

- 1 Crimp contact – Tin lead per MIL-P-81728, 50 to 70% tin, .0001 min. thick over copper
- 2 Crimp contact – Gold per MIL-G-45204, type II, grade C class 1 over copper

To order Accessories, see page 7.

# Low Mating Force

## how to order (proprietary types)

### MB, DB, IO, PC Connectors

#### Proprietary Part Number Ordering Procedure

Example part number MB2-120P- ( ) is shown as follows:

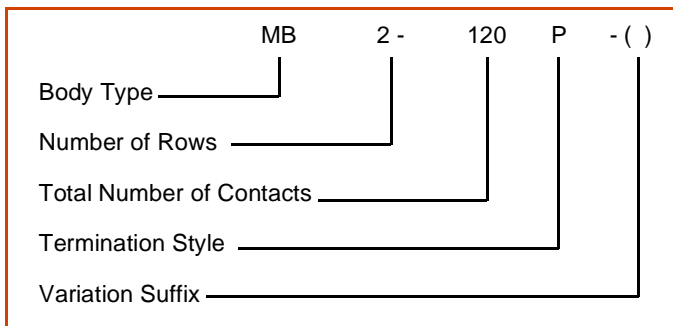

#### Body Type

MB designates Mother Board  
 DB designates Daughter Board  
 IO designates Input/Output  
 PC designates Printed Circuit

#### Number of Rows

2, 3 or 4 rows

#### Total Number of Contacts

See Contact Arrangements, pages 8 and 9

#### Standard Termination Style

(Stickout values below apply to "J" dimension referenced on individual connector catalog pages.)

|          |   |
|----------|---|
| MBX-XXXP | Straight PCB stud, .021 dia, .113 ±.025 stickout, Sn/Ni plate                         |
| MBX-XXXW | Solderless wrap, .025 sq., .507 ±.025 stickout, Sn/Ni plate                           |
| DBX-XXXP | 90° PCB stud, .021 dia, .085 ±.025 stickout, Sn/Ni plate                              |
| IOX-XXXC | Crimp, rear removable contact, size 22D wire well, Sn/Ni plate                        |
| IOX-XXXP | PCB stud, .021 dia, .145 ±.025 stickout, Sn/Ni plate                                  |
| PCX-XXXP | 90° PCB stud, .021 dia, .095 <sup>+035</sup> / <sub>-.025</sub> stickout, Sn/Ni plate |

#### LEGEND:

Sn/Ni designates Tin over Nickel  
 Au/Ni designates Gold over Nickel  
 Au/Cu designates Gold over Copper  
 SnPb/Cu designates Tin-Lead over Copper

### Variation Suffix

(Stickout values below apply to "J" dimension referenced on individual connector catalog pages.)

|       |  |
|-------|--|
| (700) | Gold plate in accordance with MIL-G-45204, type II, .000030 min. thick gold (.000050 for solderless wrap) over .000050 min. thick nickel (standard termination length) |
| (701) | Gold plate in accordance with MIL-G-45204, type II, .000050 min. thick gold over .00015 min. thick copper (standard termination length)                                |
| (702) | PCB stud stickout of .145, Sn/Ni plate, MB-P   |
| (703) | Au/Ni [same as (700)], PCB stud stickout of .145, MB-P   |
| (704) | Au/Cu [same as (701)], PCB stud stickout of .145, MB-P   |
| (705) | 90° PCB stud, .120 stickout, Sn/Ni plate, DB   |
| (706) | Au/Ni [same as (700)], 90° PCB stud .120 stickout, DB  |
| (707) | Au/Cu [same as (701)], 90° PCB .120 stickout, DB   |
| (709) | PCB stud stickout of .300 DB (90°), .300 MB-P & .335 IO-P, Sn/Ni plate   |
| (710) | Solderless wrap, .025 sq., .665 stickout, Sn/Ni plate, MB-W  |
| (711) | Solderless wrap, .025 sq., .665 stickout, Au/Ni, [same as (700)], MB-W   |
| (713) | PCB stud stickout of .060, Sn/Ni plate, IO-P   |
| (714) | 90° PCB stud stickout of .150, Sn/Ni plate, PC & DB  |
| (715) | Solderless wrap, .025 sq., .665 stickout, Au/Cu [same as (701)], MB-W  |
| (716) | 90° PCB stud stickout of .085 matte tin, DB  |
| (717) | 90° PCB stud stickout of .095 matte tin, PC  |
| (718) | 90° PCB stud stickout of .120 matte tin, DB  |
| (719) | PCB stud stickout of .300 MB-P & .335 IO-P, matte tin  |
| (720) | PCB stud stickout of .060 matte tin, IO-P  |
| (721) | PCB stud stickout of .500, Sn/Ni plate, IO-P   |
| (722) | PCB stud stickout of .356 matte tin, MB-P  |
| (723) | PCB stud stickout of .192, Sn/Ni plate, MB-P   |
| (724) | 90° PCB stud stickout of .095, RTV potted rear, Sn/Ni plate, PC  |
| (725) | 90° PCB stud stickout of .120, RTV potted rear, Sn/Ni plate, DB  |
| (726) | 90° PCB stud stickout of .150, RTV potted rear, Sn/Ni plate, PC & DB   |
| (727) | PCB stud stickout of .145, RTV potted rear, Sn/Ni plate, MB-P  |
| (728) | PCB stud stickout of .145, Au/Ni, [same as (700)], RTV potted rear, MB-P   |
| (729) | 90° PCB stud stickout of .120, Au/Ni, [same as (700)], RTV potted rear, DB   |
| (730) | 90° PCB stud stickout of .150, Au/Ni, [same as (700) above], PC and DB   |
| (731) | PCB stud stickout of .145, matte tin, MB-P   |

Variation Suffixes continued on next page.



# Low Mating Force how to order (proprietary types)/accessories

## MB, DB, IO, PC Connectors

### Proprietary Part Number Ordering Procedure

#### Variation Suffix, cont.

|       |  |
|-------|--|
| (732) | PCB stud stickout of .300 DB (90°), .300 MB-P and .335 IO-P, Au/Cu [same as (701)],                  |
| (733) | PCB stud stickout of .421, matte tin, MB-P   |
| (734) | Solderless wrap .025 sq.; .665 stickout, Au/Ni, [same as (700)], RTV potted rear, MB-W               |
| (735) | RTV potted rear, standard termination length, Au/Ni, [same as (700)]                                 |
| (736) | RTV potted rear, standard termination length, Sn/Ni [use (724) for PC]                               |
| (737) | PCB stud stickout of .300 DB (90°), .300 MB-P and .335 IO-P, Au/Ni, [same as (700)], RTV potted rear |
| (738) | PCB stud stickout of .192 SnPb/Cu (Mil-Spec), MB-P   |
| (739) | PCB stud stickout of .300 DB (90°), .300 MB-P and .335 IO-P; RTV potted rear, Sn/Ni                  |
| (740) | Solderless wrap .025 sq.; .665 stickout, Sn/Ni, RTV potted rear, MB-W                                |
| (741) | Solderless wrap .025 sq.; .280 stickout, Au/Ni, [same as (700)], MB-W                                |
| (742) | PCB .145, Au/Ni, [same as (700)], epoxy potted rear, MB-P  |
| (743) | 90° PCB .120, Au/Ni, [same as (700)], epoxy potted rear, DB  |
| (744) | 90° PCB .120, Au/Ni, [same as (700)], (MIL-Spec), epoxy potted rear, DB                              |
| (746) | 90° PCB .120, SnPb/Cu, (MIL-Spec), epoxy potted rear, DB   |
| (747) | PCB stud stickout of .200, Sn/Ni, IO-P   |
| (748) | PCB stud stickout of .145, Sn/Ni, epoxy potted rear, MB-P  |
| (749) | PCB, epoxy potted rear, standard termination length, Sn/Ni   |

|       |  |
|-------|--|
| (750) | PCB stud stickout of .172 termination, Au/Ni, [same as (700)], RTV potted rear, MB-P     |
| (751) | 90° PCB stud stickout of .150, Sn/Ni, epoxy potted rear, PC                              |
| (752) | Au/Ni, epoxy potted rear, standard termination length                                    |
| (753) | Solderless wrap .025 sq.; .665 stickout, Au/Ni, [same as (700)], epoxy potted rear, MB-W |
| (754) | PCB stud stickout of .172 termination, SnPb/Cu (MIL-Spec), MB-P                          |
| (757) | PCB stud, .391 stickout, matte tin, MB-P   |
| (758) | PCB stud, .172 stickout, Au/Ni, [same as (700)], epoxy potted rear, MB-P                 |
| (760) | PCB stud, .192 stickout, Au/Ni (Mil-Spec), MB-P  |
| (761) | 90° PCB stud, .120 stickout, Sn/Ni, epoxy potted rear, DB                                |
| (762) | PCB stud, .145 stickout, Au/Ni (Mil-Spec), epoxy potted rear, MB-P                       |
| (763) | PCB stud, .145 stickout, SnPb/Cu (Mil-Spec), epoxy potted rear, MB-P                     |
| (764) | 90° PCB stud, .150 stickout, SnPb/Cu (Mil-Spec), epoxy potted rear, DB & PC              |
| (765) | PCB stud, stickout of .300 DB (90°), .300 MB-P, SnPb/Cu (Mil-Spec), epoxy potted rear    |
| (766) | 90° PCB stud, .120 stickout, Au/Ni (Mil-Spec), epoxy potted rear, DB                     |
| (767) | PCB stud, .192 stickout, Au/Ni (Mil-Spec), epoxy potted rear, MB-P                       |
| (768) | PCB stud, .172 stickout, Au/Ni (Mil-Spec), MB-P  |
| (769) | 90° PCB stud, .200 stickout, Au/Ni (Mil-Spec), DB  |
| (770) | 90° PCB stud, .260 stickout, Au/Ni (Mil-Spec), DB  |

## Accessories

Amphenol® Low Mating Force Connectors are shipped less accessory items.

Accessories may be ordered by either military or proprietary part numbers shown below:

| Accessory Item                       | Series         | Military Part Number | Proprietary Part Number | Qty. Required |
|--------------------------------------|----------------|----------------------|-------------------------|---------------|
| Polarization Keys                    | MB, DB, IO, PC | M55302/78-02         | 10-285422-2             | 4*            |
| Locking/Mounting Bushing             | MB             | M55302/172-01        | 10-411196-3             | 2             |
| Alternate Length Bushing (Longer)    | MB             | M55302/172-02        | 10-411196-5             | 2             |
| Locking Bushing                      | PC             | M55302/172-05        | 10-411196-4             | 2             |
| Locking Screw, Plain                 | IO             | M55302/172-04        | 10-502599               | 2             |
| Locking Screw, Slotted               | IO             | -                    | 10-502599-1             | 2             |
| Locking Screw, Slotted (Low Profile) | IO             | M55302/172-03        | 10-502599-2             | 2             |
| Test Probe Kit                       | MB, DB, IO, PC | -                    | 11-10400-22             | 1**           |

See pages 28-30 for more detailed information on these accessory items.

\* 4 Keys required per connector half, if used

\*\* One kit per connector gender is recommended

# Low Mating Force contact arrangements

## Contacts

Contacts are supplied with MB, DB, IO and PC Connector Series assemblies as ordered. Replacement contacts are available; consult Amphenol Aerospace for information.

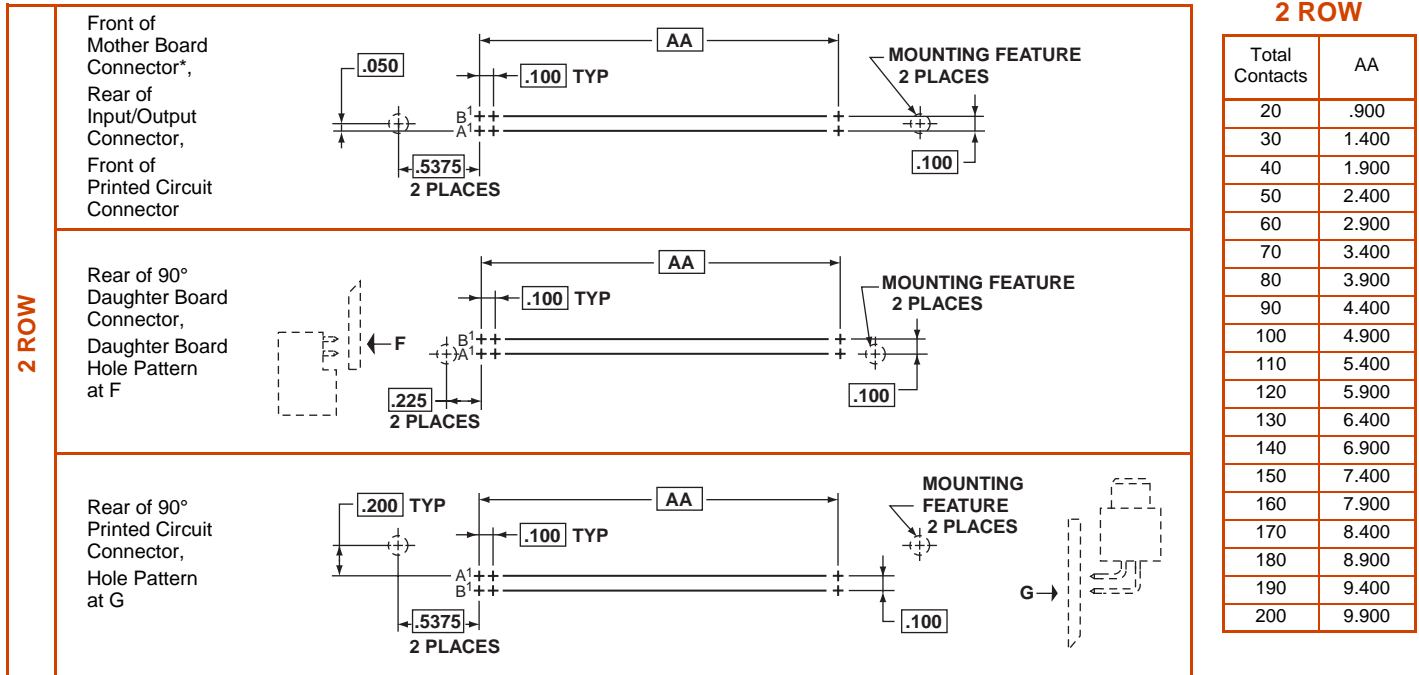

\* See contact data table on individual connector drawing pages.

† See page 16 for effective termination length dimensions.

□ Designates Basic Dimension.

Consult Amphenol drawing for solderless wrap contact fixturing (datum) hole locations to facilitate connector alignment.

# Low Mating Force contact arrangements, cont.

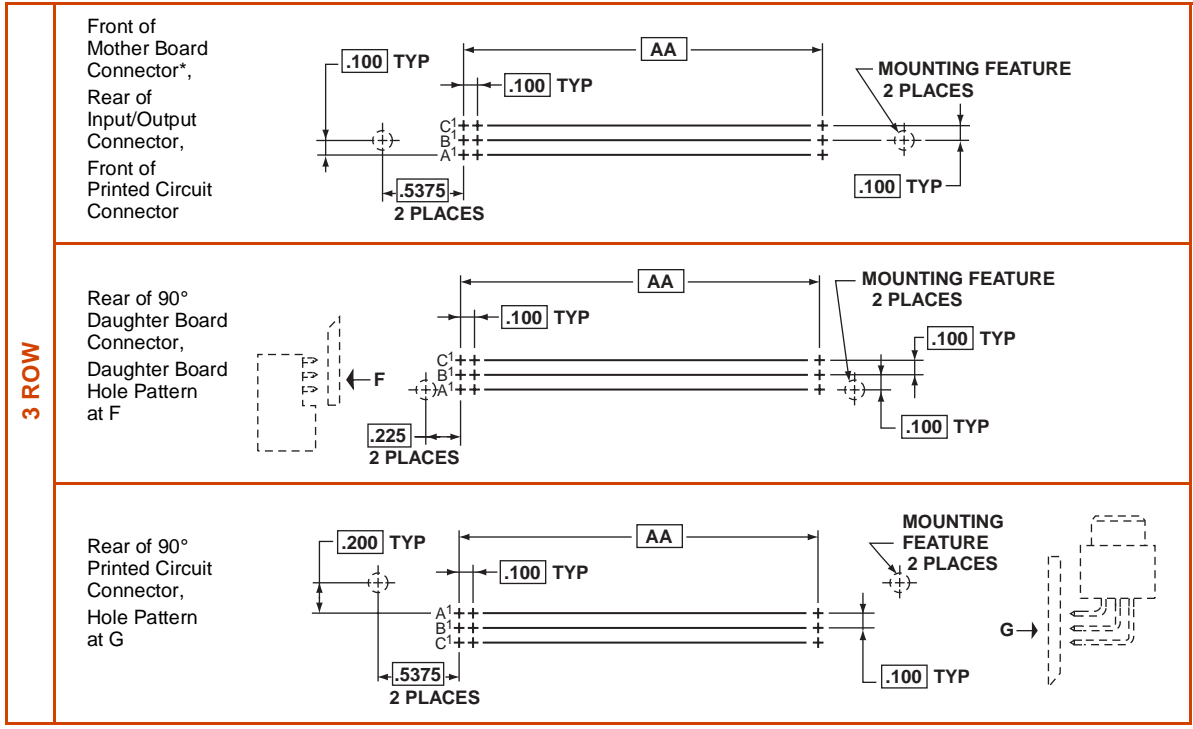

**3 ROW**

| Total Contacts | AA    |
|----------------|-------|
| 30             | .900  |
| 45             | 1.400 |
| 60             | 1.900 |
| 75             | 2.400 |
| 90             | 2.900 |
| 105            | 3.400 |
| 120            | 3.900 |
| 135            | 4.400 |
| 150            | 4.900 |
| 165            | 5.400 |
| 180            | 5.900 |
| 195            | 6.400 |
| 210            | 6.900 |
| 225            | 7.400 |
| 240            | 7.900 |
| 255            | 8.400 |
| 270            | 8.900 |
| 285            | 9.400 |
| 300            | 9.900 |

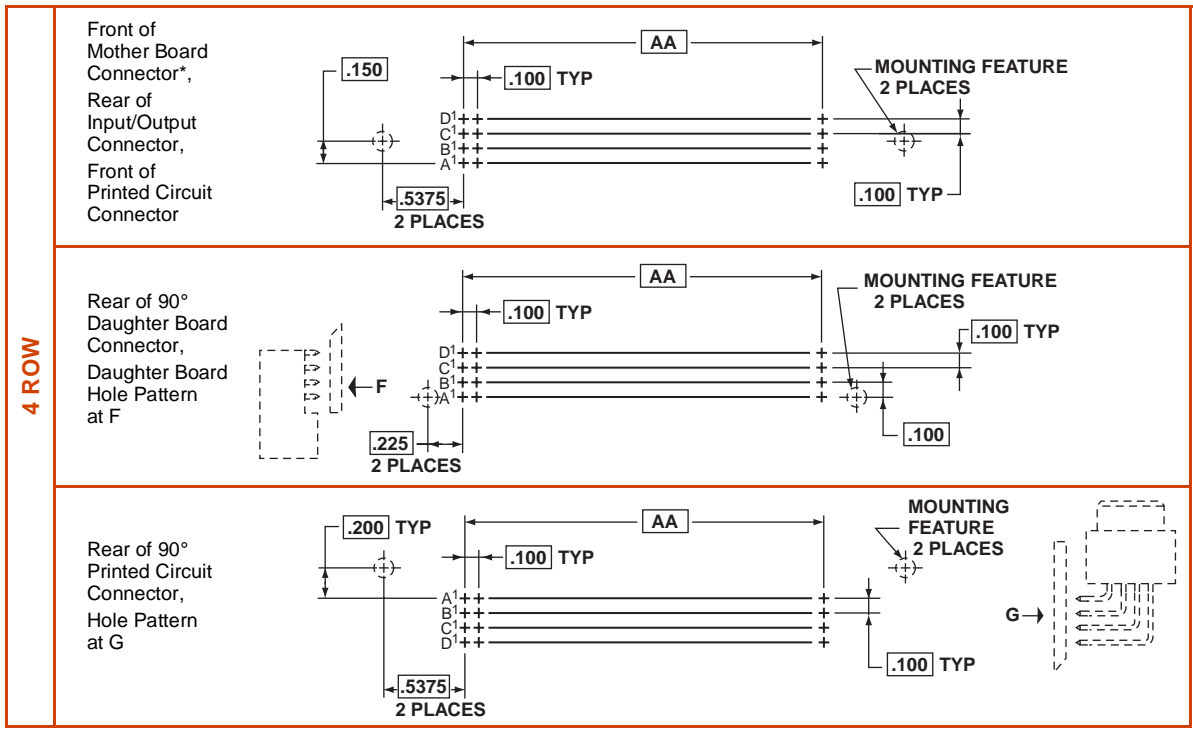

**4 ROW**

| Total Contacts | AA    |
|----------------|-------|
| 40             | .900  |
| 60             | 1.400 |
| 80             | 1.900 |
| 100            | 2.400 |
| 120            | 2.900 |
| 140            | 3.400 |
| 160            | 3.900 |
| 180            | 4.400 |
| 200            | 4.900 |
| 220            | 5.400 |
| 240            | 5.900 |
| 260            | 6.400 |
| 280            | 6.900 |
| 300            | 7.400 |
| 320            | 7.900 |
| 340            | 8.400 |
| 360            | 8.900 |
| 380            | 9.400 |
| 400            | 9.900 |

□ Designates Basic Dimension.  
 Consult Amphenol drawing for solderless wrap contact fixturing (datum) hole locations to facilitate connector alignment.

# Low Mating Force contact installation instructions, repair/replacement

Individual contacts in the B<sup>3</sup> Low Mating Force Connector line can be removed and replaced, thereby avoiding replacement of the entire connector.

## TOOLS REQUIRED:

MB, PC Series 11-10368 Tool\*  
11-10372 Insertion Tool\*  
solder removal equipment

IO Series M22520/2-01 Crimp Tool  
Daniels Tool #K743 Positioner  
10-296943-22 Removal Tool  
10-296940-22 Insertion Tool

## CONTACT REMOVAL - DB SERIES

Contact removal is accomplished from the front or mating side of this connector series without removing the entire connector from the printed circuit board. Determine which contact is to be removed from the connector and cut tail. Unsolder cut tail. Solder sucking may be necessary to clear the printed circuit board of solder and cut tail.

Pull the contact through the front side of the connector with tweezers. Care must be taken not to damage adjacent contacts. Discard the damaged contact.

## CONTACT REPLACEMENT/INSERTION - DB SERIES

Using tweezers or fingers, carefully place the replacement contact TAIL FIRST into the appropriate contact cavity in the front of the connector. Before final seating of the contact make provisions for proper dressing of the contact, since the 90° tail of the DB connector must be routed through its nest in the connector body molding and, in turn, into the printed circuit board hole.

Push the contact into the cavity with a flat-edged rod of .060 to .100 inch diameter until contact seats. Do not push against bristle wires or bend shroud. It may be necessary to simultaneously bend the contact tail during this step. Dress and resolder contact tail in proper location.

## CONTACT REMOVAL - MB, PC SERIES\*\*

Contact removal is accomplished from the front or mating side of these connector series without removing the entire connector from the printed circuit board. Determine which contact is to be removed from the connector and unsolder or unwrap the contact tail as applicable. Tail cutting and/or solder sucking may be necessary to clear the printed circuit board.

Inspect the damaged contact to determine if the bristle wires are bent in a particular direction within the contact cavity. The slot in the tube end of the 11-10368 Extraction Tool is designed to accommodate these bent strands.

Retract the plunger of the 11-10368 Extraction Tool to its furthest point of travel, and line up the slot in the tube end with any bent bristle wires in the contact cavity. Insert the tool into contact cavity. A moderate amount of resistance will be encountered until the contact retention tines are deflected, and then a positive stop will be felt.

\* Available from Amphenol Corporation, Amphenol Aerospace, Sidney NY 13838-1395. FSCM 77820

\*\* Except for MB with compliant contacts; consult Amphenol, Sidney, NY for details.



REMOVE DAMAGED CONTACT



INSERT EXTRACTION TOOL WITH PLUNGER RETRACTED

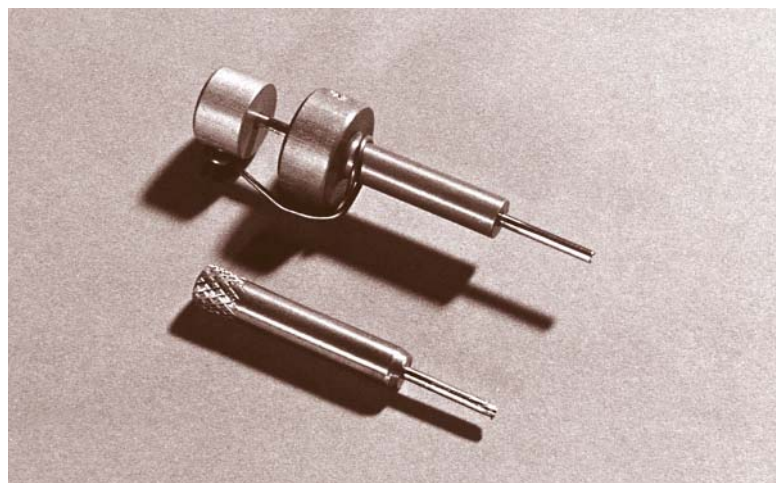

11-10368 EXTRACTION TOOL AND 11-10372 INSERTION TOOL

# Low Mating Force

## contact installation instructions, repair/replacement

Using the thumb, push the plunger portion of the Extraction Tool through the holder body into the damaged contact until a slight resistance is felt. DO NOT PUSH PLUNGER HARD ENOUGH TO CLOSE THE GAP BETWEEN IT AND THE HOLDER BODY. The contact is now ready to be removed.

While maintaining slight pressure on the plunger, withdraw tool and contact through the front of the connector body. Discard damaged contact.

### CONTACT REPLACEMENT/INSERTION - MB, PC SERIES \*

Using tweezers or fingers, carefully place the replacement contact TAIL FIRST into the appropriate contact cavity in the front of the connector. Push contact tail into the cavity until the tail centers in the molded locating ribs. DO NOT push against the bristle wires.

Position the tube end of the 11-10372 Insertion Tool over the brush contact wires. Be careful not to bend any bristle strands. Before final seating of the contact it is necessary to make provisions for proper dressing of the contact tail back into the printed circuit board hole. In the case of a 90° tail situation, extra care must be taken to dress the contact as it is being seated.

Push contact into cavity using the Insertion Tool until a positive stop is felt. Remove tool. Contact is now ready for termination.

### CONTACT REMOVAL - IO-C SERIES

Contact removal is accomplished from the rear of this connector series. Determine which contact is to be removed and locate its corresponding wire in the wire bundle. Position wire in Removal Tool (white). Slide tool along wire and insert into rear of connector body. A moderate amount of resistance will be encountered until the contact retention tines are deflected, and then a positive stop will be felt. Then, holding the wire in tension with the thumb against the tool serrations, withdraw tool, wire and contact in one steady motion. Cut off and discard damaged contact.

### CONTACT REPLACEMENT/INSERTION - IO-C SERIES

Using accepted industry procedures, strip wire end to be terminated 1/8 to 5/32 inch. Care should be taken not to nick wire strands. Assemble the M22520/2-01 Crimp Tool and Daniels K743 Positioner and place Tool Selector in correct setting for wire size being used as follows:

|     |    |    |    |    |
|-----|----|----|----|----|
| AWG | 22 | 24 | 26 | 28 |
| SEL | 5  | 4  | 3  | 2  |

Insert stripped wire end into contact wire well. Strands should be visible in wire well inspection hole. Bottom contact and wire assembly in Positioner and close handles of Crimp Tool to complete crimp. Handles will not open unless full crimping cycle has been completed. Position crimped wire and contact in Insertion tool (brown). Snug insertion tip around contact.

Insert contact and wire assembly into rear of connector. Push tool gently forward until contact is fully seated. Withdraw tool and remove from wire. A slight pull on the wire assures retention. Redress wire bundle.

\* Except for MB with compliant contacts; consult Amphenol, Sidney, NY for details.



SEAT PLUNGER AND REMOVE CONTACT AND TOOL



SEAT CONTACT WITH INSERTION TOOL

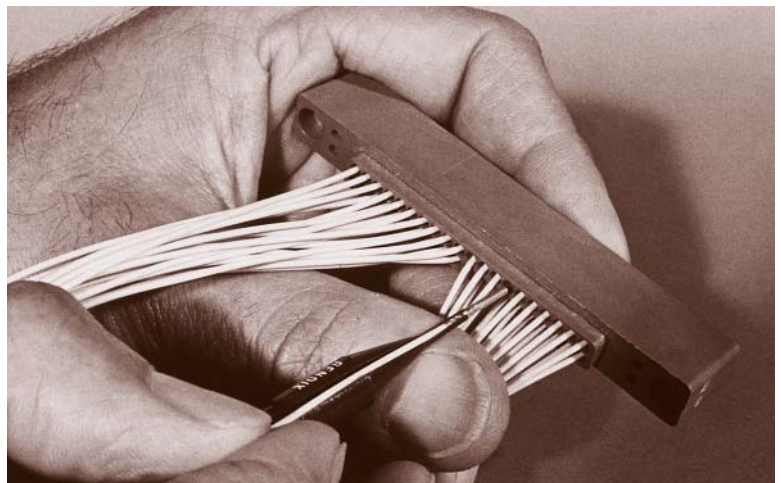

INSERT REPLACEMENT CONTACT

# Low Mating Force mother board connector

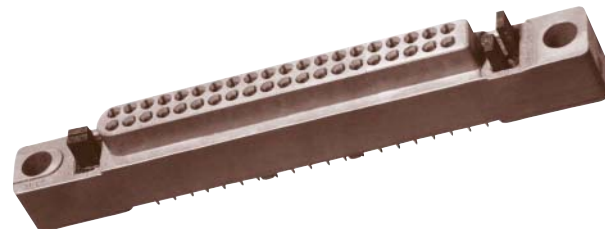
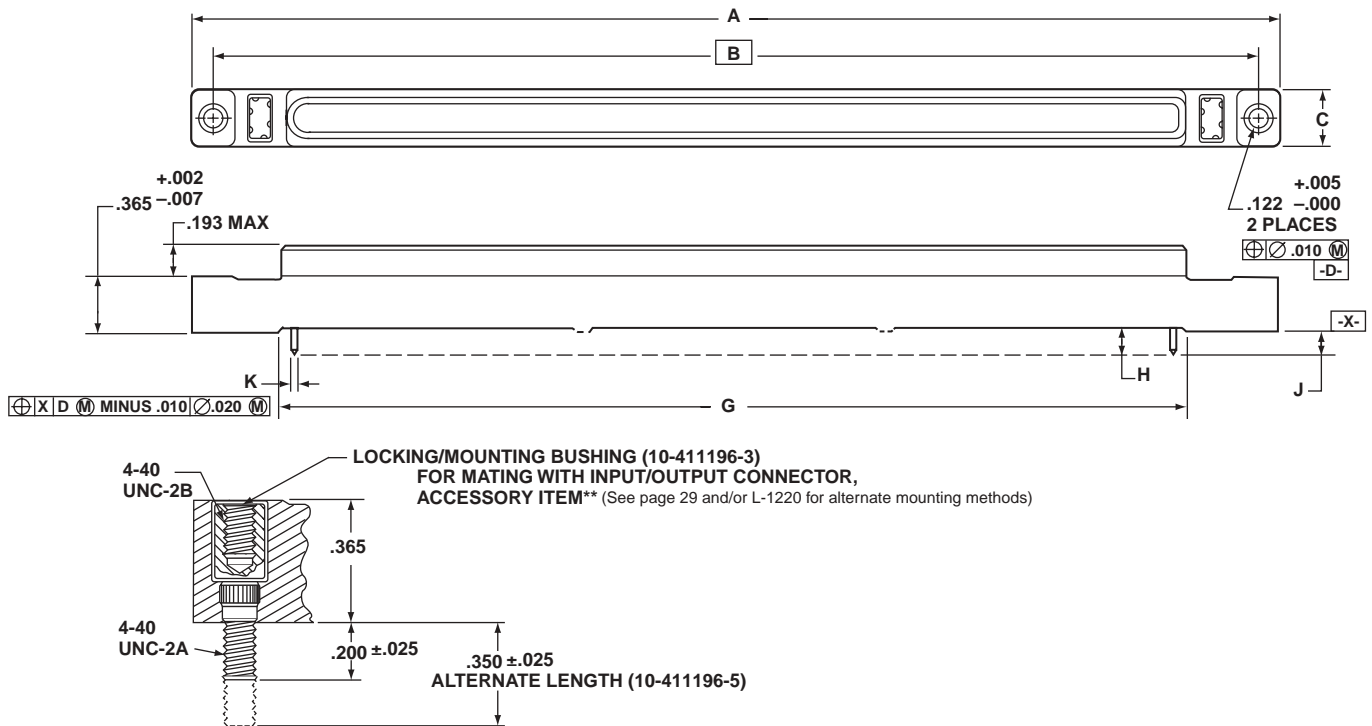

## MATES WITH DB AND IO SERIES CONNECTORS

### Notes:

When mating with DB connector, a total of .035 inch minimum radial pilot is available for connector body alignment.

All dimensions for reference only.

Polarization keys are not supplied as part of MB Connector Series assemblies. See How to Order, page 7 and further description, page 28.

\*\* Not supplied as part of MB Connector Series assemblies.

See How to Order, page 7.

□ Designates Basic Dimension

Consult Amphenol drawing for solderless wrap contact fixturing (datum) hole locations to facilitate connector alignment.

| Description                        | Contact Data             |                     |         |         |           |
|------------------------------------|--------------------------|---------------------|---------|---------|-----------|
|                                    | Termination Style Letter | Contact Part Number | H ±.020 | J ±.020 | K ±.002   |
| Round PCB                          | P                        | 10-502403-11        | .148    | .113    | .021 Dia. |
| Stud Solder Termination            | P-(702)                  | 10-502403-21        | .180    | .145    | .021 Dia. |
|                                    | P-(709)                  | 10-502403-31        | .335    | .300    | .021 Dia. |
| Square Solderless Wrap Termination | W                        | 10-502406-11        | .542    | .507    | .025 Sq.  |
|                                    | W-(710)                  | 10-502406-21        | .700    | .665    | .025 Sq.  |

NOTE: Other variations available - see pages 7 and 8, or consult Sidney, NY.

# Low Mating Force mother board connector 2 row contact arrangements

| Number of Contacts | MB Number* | A Max. | B     | C Max. | G Min. |
|--------------------|------------|--------|-------|--------|--------|
| 020                | MB2-020(*) | 2.295  | 1.975 | .390   | 1.040  |
| 022                | MB2-022(*) | 2.395  | 2.075 | .390   | 1.140  |
| 024                | MB2-024(*) | 2.495  | 2.175 | .390   | 1.240  |
| 026                | MB2-026(*) | 2.595  | 2.275 | .390   | 1.340  |
| 028                | MB2-028(*) | 2.695  | 2.375 | .390   | 1.440  |
| 030                | MB2-030(*) | 2.795  | 2.475 | .390   | 1.540  |
| 032                | MB2-032(*) | 2.895  | 2.575 | .390   | 1.640  |
| 034                | MB2-034(*) | 2.995  | 2.675 | .390   | 1.740  |
| 036                | MB2-036(*) | 3.095  | 2.775 | .390   | 1.840  |
| 038                | MB2-038(*) | 3.195  | 2.875 | .390   | 1.940  |
| 040                | MB2-040(*) | 3.295  | 2.975 | .390   | 2.040  |
| 042                | MB2-042(*) | 3.395  | 3.075 | .390   | 2.140  |
| 044                | MB2-044(*) | 3.495  | 3.175 | .390   | 2.240  |
| 046                | MB2-046(*) | 3.595  | 3.275 | .390   | 2.340  |
| 048                | MB2-048(*) | 3.695  | 3.375 | .390   | 2.440  |
| 050                | MB2-050(*) | 3.795  | 3.475 | .390   | 2.540  |
| 052                | MB2-052(*) | 3.895  | 3.575 | .390   | 2.640  |
| 054                | MB2-054(*) | 3.995  | 3.675 | .390   | 2.740  |
| 056                | MB2-056(*) | 4.095  | 3.775 | .390   | 2.840  |
| 058                | MB2-058(*) | 4.195  | 3.875 | .390   | 2.940  |
| 060                | MB2-060(*) | 4.295  | 3.975 | .390   | 3.040  |
| 062                | MB2-062(*) | 4.395  | 4.075 | .390   | 3.140  |
| 064                | MB2-064(*) | 4.495  | 4.175 | .390   | 3.240  |
| 066                | MB2-066(*) | 4.595  | 4.275 | .390   | 3.340  |
| 068                | MB2-068(*) | 4.695  | 4.375 | .390   | 3.440  |
| 070                | MB2-070(*) | 4.795  | 4.475 | .390   | 3.540  |
| 072                | MB2-072(*) | 4.895  | 4.575 | .390   | 3.640  |
| 074                | MB2-074(*) | 4.995  | 4.675 | .390   | 3.740  |
| 076                | MB2-076(*) | 5.095  | 4.775 | .390   | 3.840  |
| 078                | MB2-078(*) | 5.195  | 4.875 | .390   | 3.940  |
| 080                | MB2-080(*) | 5.295  | 4.975 | .390   | 4.040  |
| 082                | MB2-082(*) | 5.395  | 5.075 | .390   | 4.140  |
| 084                | MB2-084(*) | 5.495  | 5.175 | .390   | 4.240  |
| 086                | MB2-086(*) | 5.595  | 5.275 | .390   | 4.340  |
| 088                | MB2-088(*) | 5.695  | 5.375 | .390   | 4.440  |
| 090                | MB2-090(*) | 5.795  | 5.475 | .390   | 4.540  |
| 092                | MB2-092(*) | 5.895  | 5.575 | .390   | 4.640  |
| 094                | MB2-094(*) | 5.995  | 5.675 | .390   | 4.740  |
| 096                | MB2-096(*) | 6.095  | 5.775 | .390   | 4.840  |
| 098                | MB2-098(*) | 6.195  | 5.875 | .390   | 4.940  |
| 100                | MB2-100(*) | 6.295  | 5.975 | .390   | 5.040  |
| 102                | MB2-102(*) | 6.395  | 6.075 | .390   | 5.140  |
| 104                | MB2-104(*) | 6.495  | 6.175 | .390   | 5.240  |
| 106                | MB2-106(*) | 6.595  | 6.275 | .390   | 5.340  |
| 108                | MB2-108(*) | 6.695  | 6.375 | .390   | 5.440  |
| 110                | MB2-110(*) | 6.795  | 6.475 | .390   | 5.540  |

| Number of Contacts | MB Number* | A Max. | B      | C Max. | G Min. |
|--------------------|------------|--------|--------|--------|--------|
| 112                | MB2-112(*) | 6.895  | 6.575  | .390   | 5.640  |
| 114                | MB2-114(*) | 6.995  | 6.675  | .390   | 5.740  |
| 116                | MB2-116(*) | 7.095  | 6.775  | .390   | 5.840  |
| 118                | MB2-118(*) | 7.195  | 6.875  | .390   | 5.940  |
| 120                | MB2-120(*) | 7.295  | 6.975  | .390   | 6.040  |
| 122                | MB2-122(*) | 7.395  | 7.075  | .390   | 6.140  |
| 124                | MB2-124(*) | 7.495  | 7.175  | .390   | 6.240  |
| 126                | MB2-126(*) | 7.595  | 7.275  | .390   | 6.340  |
| 128                | MB2-128(*) | 7.695  | 7.375  | .390   | 6.440  |
| 130                | MB2-130(*) | 7.795  | 7.475  | .390   | 6.540  |
| 132                | MB2-132(*) | 7.895  | 7.575  | .390   | 6.640  |
| 134                | MB2-134(*) | 7.995  | 7.675  | .390   | 6.740  |
| 136                | MB2-136(*) | 8.095  | 7.775  | .390   | 6.840  |
| 138                | MB2-138(*) | 8.195  | 7.875  | .390   | 6.940  |
| 140                | MB2-140(*) | 8.295  | 7.975  | .390   | 7.040  |
| 142                | MB2-142(*) | 8.395  | 8.075  | .390   | 7.140  |
| 144                | MB2-144(*) | 8.495  | 8.175  | .390   | 7.240  |
| 146                | MB2-146(*) | 8.595  | 8.275  | .390   | 7.340  |
| 148                | MB2-148(*) | 8.695  | 8.375  | .390   | 7.440  |
| 150                | MB2-150(*) | 8.795  | 8.475  | .390   | 7.540  |
| 152                | MB2-152(*) | 8.895  | 8.575  | .390   | 7.640  |
| 154                | MB2-154(*) | 8.995  | 8.675  | .390   | 7.740  |
| 156                | MB2-156(*) | 9.095  | 8.775  | .390   | 7.840  |
| 158                | MB2-158(*) | 9.195  | 8.875  | .390   | 7.940  |
| 160                | MB2-160(*) | 9.295  | 8.975  | .390   | 8.040  |
| 162                | MB2-162(*) | 9.395  | 9.075  | .390   | 8.140  |
| 164                | MB2-164(*) | 9.495  | 9.175  | .390   | 8.240  |
| 166                | MB2-166(*) | 9.595  | 9.275  | .390   | 8.340  |
| 168                | MB2-168(*) | 9.695  | 9.375  | .390   | 8.440  |
| 170                | MB2-170(*) | 9.795  | 9.475  | .390   | 8.540  |
| 172                | MB2-172(*) | 9.895  | 9.575  | .390   | 8.640  |
| 174                | MB2-174(*) | 9.995  | 9.675  | .390   | 8.740  |
| 176                | MB2-176(*) | 10.095 | 9.775  | .390   | 8.840  |
| 178                | MB2-178(*) | 10.195 | 9.875  | .390   | 8.940  |
| 180                | MB2-180(*) | 10.295 | 9.975  | .390   | 9.040  |
| 182                | MB2-182(*) | 10.395 | 10.075 | .390   | 9.140  |
| 184                | MB2-184(*) | 10.495 | 10.175 | .390   | 9.240  |
| 186                | MB2-186(*) | 10.595 | 10.275 | .390   | 9.340  |
| 188                | MB2-188(*) | 10.695 | 10.375 | .390   | 9.440  |
| 190                | MB2-190(*) | 10.795 | 10.475 | .390   | 9.540  |
| 192                | MB2-192(*) | 10.895 | 10.575 | .390   | 9.640  |
| 194                | MB2-194(*) | 10.995 | 10.675 | .390   | 9.740  |
| 196                | MB2-196(*) | 11.095 | 10.775 | .390   | 9.840  |
| 198                | MB2-198(*) | 11.195 | 10.875 | .390   | 9.940  |
| 200                | MB2-200(*) | 11.295 | 10.975 | .390   | 10.040 |

\*See How to Order, pages 5, 6 and 7

# Low Mating Force

## mother board connector

### 3 row contact arrangements

| Number of Contacts | MB Number* | A Max. | B     | C Max. | G Min. |
|--------------------|------------|--------|-------|--------|--------|
| 030                | MB3-030(*) | 2.295  | 1.975 | .490   | 1.040  |
| 033                | MB3-033(*) | 2.395  | 2.075 | .490   | 1.140  |
| 036                | MB3-036(*) | 2.495  | 2.175 | .490   | 1.240  |
| 039                | MB3-039(*) | 2.595  | 2.275 | .490   | 1.340  |
| 042                | MB3-042(*) | 2.695  | 2.375 | .490   | 1.440  |
| 045                | MB3-045(*) | 2.795  | 2.475 | .490   | 1.540  |
| 048                | MB3-048(*) | 2.895  | 2.575 | .490   | 1.640  |
| 051                | MB3-051(*) | 2.995  | 2.675 | .490   | 1.740  |
| 054                | MB3-054(*) | 3.095  | 2.775 | .490   | 1.840  |
| 057                | MB3-057(*) | 3.195  | 2.875 | .490   | 1.940  |
| 060                | MB3-060(*) | 3.295  | 2.975 | .490   | 2.040  |
| 063                | MB3-063(*) | 3.395  | 3.075 | .490   | 2.140  |
| 066                | MB3-066(*) | 3.495  | 3.175 | .490   | 2.240  |
| 069                | MB3-069(*) | 3.595  | 3.275 | .490   | 2.340  |
| 072                | MB3-072(*) | 3.695  | 3.375 | .490   | 2.440  |
| 075                | MB3-075(*) | 3.795  | 3.475 | .490   | 2.540  |
| 078                | MB3-078(*) | 3.895  | 3.575 | .490   | 2.640  |
| 081                | MB3-081(*) | 3.995  | 3.675 | .490   | 2.740  |
| 084                | MB3-084(*) | 4.095  | 3.775 | .490   | 2.840  |
| 087                | MB3-087(*) | 4.195  | 3.875 | .490   | 2.940  |
| 090                | MB3-090(*) | 4.295  | 3.975 | .490   | 3.040  |
| 093                | MB3-093(*) | 4.395  | 4.075 | .490   | 3.140  |
| 096                | MB3-096(*) | 4.495  | 4.175 | .490   | 3.240  |
| 099                | MB3-099(*) | 4.595  | 4.275 | .490   | 3.340  |
| 102                | MB3-102(*) | 4.695  | 4.375 | .490   | 3.440  |
| 105                | MB3-105(*) | 4.795  | 4.475 | .490   | 3.540  |
| 108                | MB3-108(*) | 4.895  | 4.575 | .490   | 3.640  |
| 111                | MB3-111(*) | 4.995  | 4.675 | .490   | 3.740  |
| 114                | MB3-114(*) | 5.095  | 4.775 | .490   | 3.840  |
| 117                | MB3-117(*) | 5.195  | 4.875 | .490   | 3.940  |
| 120                | MB3-120(*) | 5.295  | 4.975 | .490   | 4.040  |
| 123                | MB3-123(*) | 5.395  | 5.075 | .490   | 4.140  |
| 126                | MB3-126(*) | 5.495  | 5.175 | .490   | 4.240  |
| 129                | MB3-129(*) | 5.595  | 5.275 | .490   | 4.340  |
| 132                | MB3-132(*) | 5.695  | 5.375 | .490   | 4.440  |
| 135                | MB3-135(*) | 5.795  | 5.475 | .490   | 4.540  |
| 138                | MB3-138(*) | 5.895  | 5.575 | .490   | 4.640  |
| 141                | MB3-141(*) | 5.995  | 5.675 | .490   | 4.740  |
| 144                | MB3-144(*) | 6.095  | 5.775 | .490   | 4.840  |
| 147                | MB3-147(*) | 6.195  | 5.875 | .490   | 4.940  |
| 150                | MB3-150(*) | 6.295  | 5.975 | .490   | 5.040  |
| 153                | MB3-153(*) | 6.395  | 6.075 | .490   | 5.140  |
| 156                | MB3-156(*) | 6.495  | 6.175 | .490   | 5.240  |
| 159                | MB3-159(*) | 6.595  | 6.275 | .490   | 5.340  |
| 162                | MB3-162(*) | 6.695  | 6.375 | .490   | 5.440  |
| 165                | MB3-165(*) | 6.795  | 6.475 | .490   | 5.540  |

| Number of Contacts | MB Number* | A Max. | B      | C Max. | G Min. |
|--------------------|------------|--------|--------|--------|--------|
| 168                | MB3-168(*) | 6.895  | 6.575  | .490   | 5.640  |
| 171                | MB3-171(*) | 6.995  | 6.675  | .490   | 5.740  |
| 174                | MB3-174(*) | 7.095  | 6.775  | .490   | 5.840  |
| 177                | MB3-177(*) | 7.195  | 6.875  | .490   | 5.940  |
| 180                | MB3-180(*) | 7.295  | 6.975  | .490   | 6.040  |
| 183                | MB3-183(*) | 7.395  | 7.075  | .490   | 6.140  |
| 186                | MB3-186(*) | 7.495  | 7.175  | .490   | 6.240  |
| 189                | MB3-189(*) | 7.595  | 7.275  | .490   | 6.340  |
| 192                | MB3-192(*) | 7.695  | 7.375  | .490   | 6.440  |
| 195                | MB3-195(*) | 7.795  | 7.475  | .490   | 6.540  |
| 198                | MB3-198(*) | 7.895  | 7.575  | .490   | 6.640  |
| 201                | MB3-201(*) | 7.995  | 7.675  | .490   | 6.740  |
| 204                | MB3-204(*) | 8.095  | 7.775  | .490   | 6.840  |
| 207                | MB3-207(*) | 8.195  | 7.875  | .490   | 6.940  |
| 210                | MB3-210(*) | 8.295  | 7.975  | .490   | 7.040  |
| 213                | MB3-213(*) | 8.395  | 8.075  | .490   | 7.140  |
| 216                | MB3-216(*) | 8.495  | 8.175  | .490   | 7.240  |
| 219                | MB3-219(*) | 8.595  | 8.275  | .490   | 7.340  |
| 222                | MB3-222(*) | 8.695  | 8.375  | .490   | 7.440  |
| 225                | MB3-225(*) | 8.795  | 8.475  | .490   | 7.540  |
| 228                | MB3-228(*) | 8.895  | 8.575  | .490   | 7.640  |
| 231                | MB3-231(*) | 8.995  | 8.675  | .490   | 7.740  |
| 234                | MB3-234(*) | 9.095  | 8.775  | .490   | 7.840  |
| 237                | MB3-237(*) | 9.195  | 8.875  | .490   | 7.940  |
| 240                | MB3-240(*) | 9.295  | 8.975  | .490   | 8.040  |
| 243                | MB3-243(*) | 9.395  | 9.075  | .490   | 8.140  |
| 246                | MB3-246(*) | 9.495  | 9.175  | .490   | 8.240  |
| 249                | MB3-249(*) | 9.595  | 9.275  | .490   | 8.340  |
| 252                | MB3-252(*) | 9.695  | 9.375  | .490   | 8.440  |
| 255                | MB3-255(*) | 9.795  | 9.475  | .490   | 8.540  |
| 258                | MB3-258(*) | 9.895  | 9.575  | .490   | 8.640  |
| 261                | MB3-261(*) | 9.995  | 9.675  | .490   | 8.740  |
| 264                | MB3-264(*) | 10.095 | 9.775  | .490   | 8.840  |
| 267                | MB3-267(*) | 10.195 | 9.875  | .490   | 8.940  |
| 270                | MB3-270(*) | 10.295 | 9.975  | .490   | 9.040  |
| 273                | MB3-273(*) | 10.395 | 10.075 | .490   | 9.140  |
| 276                | MB3-276(*) | 10.495 | 10.175 | .490   | 9.240  |
| 279                | MB3-279(*) | 10.595 | 10.275 | .490   | 9.340  |
| 282                | MB3-282(*) | 10.695 | 10.375 | .490   | 9.440  |
| 285                | MB3-285(*) | 10.795 | 10.475 | .490   | 9.540  |
| 288                | MB3-288(*) | 10.895 | 10.575 | .490   | 9.640  |
| 291                | MB3-291(*) | 10.995 | 10.675 | .490   | 9.740  |
| 294                | MB3-294(*) | 11.095 | 10.775 | .490   | 9.840  |
| 297                | MB3-297(*) | 11.195 | 10.875 | .490   | 9.940  |
| 300                | MB3-300(*) | 11.295 | 10.975 | .490   | 10.040 |

\*See How to Order, pages 5, 6 and 7



# Low Mating Force mother board connector 4 row contact arrangements

| Number of Contacts | MB Number* | A Max. | B     | C Max. | G Min. |
|--------------------|------------|--------|-------|--------|--------|
| 040                | MB4-040(*) | 2.295  | 1.975 | .590   | 1.040  |
| 044                | MB4-044(*) | 2.395  | 2.075 | .590   | 1.140  |
| 048                | MB4-048(*) | 2.495  | 2.175 | .590   | 1.240  |
| 052                | MB4-052(*) | 2.595  | 2.275 | .590   | 1.340  |
| 056                | MB4-056(*) | 2.695  | 2.375 | .590   | 1.440  |
| 060                | MB4-060(*) | 2.795  | 2.475 | .590   | 1.540  |
| 064                | MB4-064(*) | 2.895  | 2.575 | .590   | 1.640  |
| 068                | MB4-068(*) | 2.995  | 2.675 | .590   | 1.740  |
| 072                | MB4-072(*) | 3.095  | 2.775 | .590   | 1.840  |
| 076                | MB4-076(*) | 3.195  | 2.875 | .590   | 1.940  |
| 080                | MB4-080(*) | 3.295  | 2.975 | .590   | 2.040  |
| 084                | MB4-084(*) | 3.395  | 3.075 | .590   | 2.140  |
| 088                | MB4-088(*) | 3.495  | 3.175 | .590   | 2.240  |
| 092                | MB4-092(*) | 3.595  | 3.275 | .590   | 2.340  |
| 096                | MB4-096(*) | 3.695  | 3.375 | .590   | 2.440  |
| 100                | MB4-100(*) | 3.795  | 3.475 | .590   | 2.540  |
| 104                | MB4-104(*) | 3.895  | 3.575 | .590   | 2.640  |
| 108                | MB4-108(*) | 3.995  | 3.675 | .590   | 2.740  |
| 112                | MB4-112(*) | 4.095  | 3.775 | .590   | 2.840  |
| 116                | MB4-116(*) | 4.195  | 3.875 | .590   | 2.940  |
| 120                | MB4-120(*) | 4.295  | 3.975 | .590   | 3.040  |
| 124                | MB4-124(*) | 4.395  | 4.075 | .590   | 3.140  |
| 128                | MB4-128(*) | 4.495  | 4.175 | .590   | 3.240  |
| 132                | MB4-132(*) | 4.595  | 4.275 | .590   | 3.340  |
| 136                | MB4-136(*) | 4.695  | 4.375 | .590   | 3.440  |
| 140                | MB4-140(*) | 4.795  | 4.475 | .590   | 3.540  |
| 144                | MB4-144(*) | 4.895  | 4.575 | .590   | 3.640  |
| 148                | MB4-148(*) | 4.995  | 4.675 | .590   | 3.740  |
| 152                | MB4-152(*) | 5.095  | 4.775 | .590   | 3.840  |
| 156                | MB4-156(*) | 5.195  | 4.875 | .590   | 3.940  |
| 160                | MB4-160(*) | 5.295  | 4.975 | .590   | 4.040  |
| 164                | MB4-164(*) | 5.395  | 5.075 | .590   | 4.140  |
| 168                | MB4-168(*) | 5.495  | 5.175 | .590   | 4.240  |
| 172                | MB4-172(*) | 5.595  | 5.275 | .590   | 4.340  |
| 176                | MB4-176(*) | 5.695  | 5.375 | .590   | 4.440  |
| 180                | MB4-180(*) | 5.795  | 5.475 | .590   | 4.540  |
| 184                | MB4-184(*) | 5.895  | 5.575 | .590   | 4.640  |
| 188                | MB4-188(*) | 5.995  | 5.675 | .590   | 4.740  |
| 192                | MB4-192(*) | 6.095  | 5.775 | .590   | 4.840  |
| 196                | MB4-196(*) | 6.195  | 5.875 | .590   | 4.940  |
| 200                | MB4-200(*) | 6.295  | 5.975 | .590   | 5.040  |
| 204                | MB4-204(*) | 6.395  | 6.075 | .590   | 5.140  |
| 208                | MB4-208(*) | 6.495  | 6.175 | .590   | 5.240  |
| 212                | MB4-212(*) | 6.595  | 6.275 | .590   | 5.340  |
| 216                | MB4-216(*) | 6.695  | 6.375 | .590   | 5.440  |
| 220                | MB4-220(*) | 6.795  | 6.475 | .590   | 5.540  |

| Number of Contacts | MB Number* | A Max. | B      | C Max. | G Min. |
|--------------------|------------|--------|--------|--------|--------|
| 224                | MB4-224(*) | 6.895  | 6.575  | .590   | 5.640  |
| 228                | MB4-228(*) | 6.995  | 6.675  | .590   | 5.740  |
| 232                | MB4-232(*) | 7.095  | 6.775  | .590   | 5.840  |
| 236                | MB4-236(*) | 7.195  | 6.875  | .590   | 5.940  |
| 240                | MB4-240(*) | 7.295  | 6.975  | .590   | 6.040  |
| 244                | MB4-244(*) | 7.395  | 7.075  | .590   | 6.140  |
| 248                | MB4-248(*) | 7.495  | 7.175  | .590   | 6.240  |
| 252                | MB4-252(*) | 7.595  | 7.275  | .590   | 6.340  |
| 256                | MB4-256(*) | 7.695  | 7.375  | .590   | 6.440  |
| 260                | MB4-260(*) | 7.795  | 7.475  | .590   | 6.540  |
| 264                | MB4-264(*) | 7.895  | 7.575  | .590   | 6.640  |
| 268                | MB4-268(*) | 7.995  | 7.675  | .590   | 6.740  |
| 272                | MB4-272(*) | 8.095  | 7.775  | .590   | 6.840  |
| 276                | MB4-276(*) | 8.195  | 7.875  | .590   | 6.940  |
| 280                | MB4-280(*) | 8.295  | 7.975  | .590   | 7.040  |
| 284                | MB4-284(*) | 8.395  | 8.075  | .590   | 7.140  |
| 288                | MB4-288(*) | 8.495  | 8.175  | .590   | 7.240  |
| 292                | MB4-292(*) | 8.595  | 8.275  | .590   | 7.340  |
| 296                | MB4-296(*) | 8.695  | 8.375  | .590   | 7.440  |
| 300                | MB4-300(*) | 8.795  | 8.475  | .590   | 7.540  |
| 304                | MB4-304(*) | 8.895  | 8.575  | .590   | 7.640  |
| 308                | MB4-308(*) | 8.995  | 8.675  | .590   | 7.740  |
| 312                | MB4-312(*) | 9.095  | 8.775  | .590   | 7.840  |
| 316                | MB4-316(*) | 9.195  | 8.875  | .590   | 7.940  |
| 320                | MB4-320(*) | 9.295  | 8.975  | .590   | 8.040  |
| 324                | MB4-324(*) | 9.395  | 9.075  | .590   | 8.140  |
| 328                | MB4-328(*) | 9.495  | 9.175  | .590   | 8.240  |
| 332                | MB4-332(*) | 9.595  | 9.275  | .590   | 8.340  |
| 336                | MB4-336(*) | 9.695  | 9.375  | .590   | 8.440  |
| 340                | MB4-340(*) | 9.795  | 9.475  | .590   | 8.540  |
| 344                | MB4-344(*) | 9.895  | 9.575  | .590   | 8.640  |
| 348                | MB4-348(*) | 9.995  | 9.675  | .590   | 8.740  |
| 352                | MB4-352(*) | 10.095 | 9.775  | .590   | 8.840  |
| 356                | MB4-356(*) | 10.195 | 9.875  | .590   | 8.940  |
| 360                | MB4-360(*) | 10.295 | 9.975  | .590   | 9.040  |
| 364                | MB4-364(*) | 10.395 | 10.075 | .590   | 9.140  |
| 368                | MB4-368(*) | 10.495 | 10.175 | .590   | 9.240  |
| 372                | MB4-372(*) | 10.595 | 10.275 | .590   | 9.340  |
| 376                | MB4-376(*) | 10.695 | 10.375 | .590   | 9.440  |
| 380                | MB4-380(*) | 10.795 | 10.475 | .590   | 9.540  |
| 384                | MB4-384(*) | 10.895 | 10.575 | .590   | 9.640  |
| 388                | MB4-388(*) | 10.995 | 10.675 | .590   | 9.740  |
| 392                | MB4-392(*) | 11.095 | 10.775 | .590   | 9.840  |
| 396                | MB4-396(*) | 11.195 | 10.875 | .590   | 9.940  |
| 400                | MB4-400(*) | 11.295 | 10.975 | .590   | 10.040 |

\*See How to Order, pages 5, 6 and 7

# Low Mating Force daughter board connector

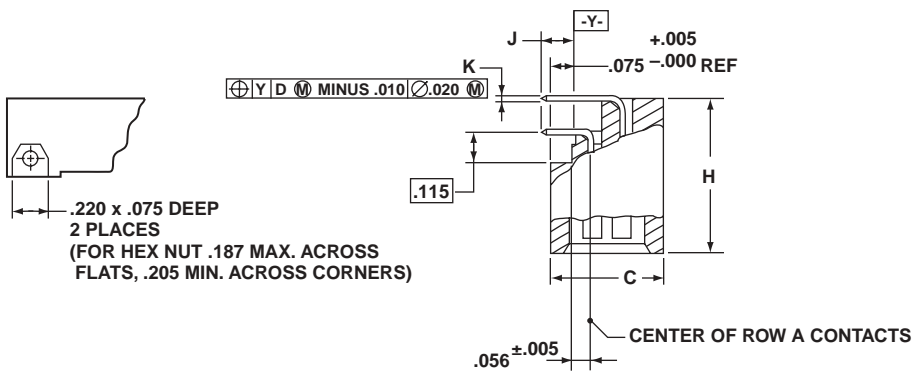
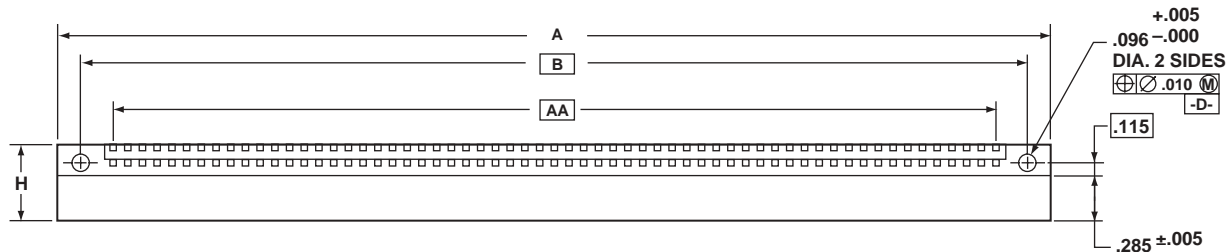

## MATES WITH MB AND PC SERIES CONNECTORS

### Notes:

When mating with MB or PC connector, a total of .035 inch minimum radial pilot is available for connector body alignment.

All dimensions for reference only.

Polarization keys are not supplied as part of DB Connector Series assemblies. See How to Order, page 7 and further description, page 28.

□ Designates Basic Dimension

| Description                            | Contact Data             |                 |                     |           |           |
|--|--------------------------|-----------------|---------------------|-----------|-----------|
|  | Termination Style Letter | Arrangement Row | Contact Part Number | J ±.020   | K ±.002   |
| Round PCB Stud, 90° Solder Termination | P                        | A               | 10-502400-111       | .085      | .021 Dia. |
|  | P                        | B               | 10-502400-211       | .085      | .021 Dia. |
|  | P                        | C               | 10-502400-311       | .085      | .021 Dia. |
|  | P                        | D               | 10-502400-411       | .085      | .021 Dia. |
|  | P-(705)                  | A               | 10-502400-121       | .120      | .021 Dia. |
|  | P-(705)                  | B               | 10-502400-221       | .120      | .021 Dia. |
|  | P-(705)                  | C               | 10-502400-321       | .120      | .021 Dia. |
|  | P-(705)                  | D               | 10-502400-421       | .120      | .021 Dia. |
|  | P-(709)                  | A               | 10-502400-131       | .300      | .021 Dia. |
|  | P-(709)                  | B               | 10-502400-231       | .300      | .021 Dia. |
| P-(709)                                | C                        | 10-502400-331   | .300                | .021 Dia. |           |
| P-(709)                                | D                        | 10-502400-431   | .300                | .021 Dia. |           |

NOTE: Other variations available - see pages 7 and 8, or consult Sidney, NY.

# Low Mating Force daughter board connector 2 row contact arrangements

| Number of Contacts | DB Number* | A Max. | B     | C Max. | H Max. | AA    |
|--------------------|------------|--------|-------|--------|--------|-------|
| 020                | DB2-020P   | 1.680  | 1.350 | .375   | .545   | .900  |
| 022                | DB2-022P   | 1.780  | 1.450 | .375   | .545   | 1.000 |
| 024                | DB2-024P   | 1.880  | 1.550 | .375   | .545   | 1.100 |
| 026                | DB2-026P   | 1.980  | 1.650 | .375   | .545   | 1.200 |
| 028                | DB2-028P   | 2.080  | 1.750 | .375   | .545   | 1.300 |
| 030                | DB2-030P   | 2.180  | 1.850 | .375   | .545   | 1.400 |
| 032                | DB2-032P   | 2.280  | 1.950 | .375   | .545   | 1.500 |
| 034                | DB2-034P   | 2.380  | 2.050 | .375   | .545   | 1.600 |
| 036                | DB2-036P   | 2.480  | 2.150 | .375   | .545   | 1.700 |
| 038                | DB2-038P   | 2.580  | 2.250 | .375   | .545   | 1.800 |
| 040                | DB2-040P   | 2.680  | 2.350 | .375   | .545   | 1.900 |
| 042                | DB2-042P   | 2.780  | 2.450 | .375   | .545   | 2.000 |
| 044                | DB2-044P   | 2.880  | 2.550 | .375   | .545   | 2.100 |
| 046                | DB2-046P   | 2.980  | 2.650 | .375   | .545   | 2.200 |
| 048                | DB2-048P   | 3.080  | 2.750 | .375   | .545   | 2.300 |
| 050                | DB2-050P   | 3.180  | 2.850 | .375   | .545   | 2.400 |
| 052                | DB2-052P   | 3.280  | 2.950 | .375   | .545   | 2.500 |
| 054                | DB2-054P   | 3.380  | 3.050 | .375   | .545   | 2.600 |
| 056                | DB2-056P   | 3.480  | 3.150 | .375   | .545   | 2.700 |
| 058                | DB2-058P   | 3.580  | 3.250 | .375   | .545   | 2.800 |
| 060                | DB2-060P   | 3.680  | 3.350 | .375   | .545   | 2.900 |
| 062                | DB2-062P   | 3.780  | 3.450 | .375   | .545   | 3.000 |
| 064                | DB2-064P   | 3.880  | 3.550 | .375   | .545   | 3.100 |
| 066                | DB2-066P   | 3.980  | 3.650 | .375   | .545   | 3.200 |
| 068                | DB2-068P   | 4.080  | 3.750 | .375   | .545   | 3.300 |
| 070                | DB2-070P   | 4.180  | 3.850 | .375   | .545   | 3.400 |
| 072                | DB2-072P   | 4.280  | 3.950 | .375   | .545   | 3.500 |
| 074                | DB2-074P   | 4.380  | 4.050 | .375   | .545   | 3.600 |
| 076                | DB2-076P   | 4.480  | 4.150 | .375   | .545   | 3.700 |
| 078                | DB2-078P   | 4.580  | 4.250 | .375   | .545   | 3.800 |
| 080                | DB2-080P   | 4.680  | 4.350 | .375   | .545   | 3.900 |
| 082                | DB2-082P   | 4.780  | 4.450 | .375   | .545   | 4.000 |
| 084                | DB2-084P   | 4.880  | 4.550 | .375   | .545   | 4.100 |
| 086                | DB2-086P   | 4.980  | 4.650 | .375   | .545   | 4.200 |
| 088                | DB2-088P   | 5.080  | 4.750 | .375   | .545   | 4.300 |
| 090                | DB2-090P   | 5.180  | 4.850 | .375   | .545   | 4.400 |
| 092                | DB2-092P   | 5.280  | 4.950 | .375   | .545   | 4.500 |
| 094                | DB2-094P   | 5.380  | 5.050 | .375   | .545   | 4.600 |
| 096                | DB2-096P   | 5.480  | 5.150 | .375   | .545   | 4.700 |
| 098                | DB2-098P   | 5.580  | 5.250 | .375   | .545   | 4.800 |
| 100                | DB2-100P   | 5.680  | 5.350 | .375   | .545   | 4.900 |
| 102                | DB2-102P   | 5.780  | 5.450 | .375   | .545   | 5.000 |
| 104                | DB2-104P   | 5.880  | 5.550 | .375   | .545   | 5.100 |
| 106                | DB2-106P   | 5.980  | 5.650 | .375   | .545   | 5.200 |
| 108                | DB2-108P   | 6.080  | 5.750 | .375   | .545   | 5.300 |
| 110                | DB2-110P   | 6.180  | 5.850 | .375   | .545   | 5.400 |

| Number of Contacts | DB Number* | A Max. | B      | C Max. | H Max. | AA    |
|--------------------|------------|--------|--------|--------|--------|-------|
| 112                | DB2-112P   | 6.280  | 5.950  | .375   | .545   | 5.500 |
| 114                | DB2-114P   | 6.380  | 6.050  | .375   | .545   | 5.600 |
| 116                | DB2-116P   | 6.480  | 6.150  | .375   | .545   | 5.700 |
| 118                | DB2-118P   | 6.580  | 6.250  | .375   | .545   | 5.800 |
| 120                | DB2-120P   | 6.680  | 6.350  | .375   | .545   | 5.900 |
| 122                | DB2-122P   | 6.780  | 6.450  | .375   | .545   | 6.000 |
| 124                | DB2-124P   | 6.880  | 6.550  | .375   | .545   | 6.100 |
| 126                | DB2-126P   | 6.980  | 6.650  | .375   | .545   | 6.200 |
| 128                | DB2-128P   | 7.080  | 6.750  | .375   | .545   | 6.300 |
| 130                | DB2-130P   | 7.180  | 6.850  | .375   | .545   | 6.400 |
| 132                | DB2-132P   | 7.280  | 6.950  | .375   | .545   | 6.500 |
| 134                | DB2-134P   | 7.380  | 7.050  | .375   | .545   | 6.600 |
| 136                | DB2-136P   | 7.480  | 7.150  | .375   | .545   | 6.700 |
| 138                | DB2-138P   | 7.580  | 7.250  | .375   | .545   | 6.800 |
| 140                | DB2-140P   | 7.680  | 7.350  | .375   | .545   | 6.900 |
| 142                | DB2-142P   | 7.780  | 7.450  | .375   | .545   | 7.000 |
| 144                | DB2-144P   | 7.880  | 7.550  | .375   | .545   | 7.100 |
| 146                | DB2-146P   | 7.980  | 7.650  | .375   | .545   | 7.200 |
| 148                | DB2-148P   | 8.080  | 7.750  | .375   | .545   | 7.300 |
| 150                | DB2-150P   | 8.180  | 7.850  | .375   | .545   | 7.400 |
| 152                | DB2-152P   | 8.280  | 7.950  | .375   | .545   | 7.500 |
| 154                | DB2-154P   | 8.380  | 8.050  | .375   | .545   | 7.600 |
| 156                | DB2-156P   | 8.480  | 8.150  | .375   | .545   | 7.700 |
| 158                | DB2-158P   | 8.580  | 8.250  | .375   | .545   | 7.800 |
| 160                | DB2-160P   | 8.680  | 8.350  | .375   | .545   | 7.900 |
| 162                | DB2-162P   | 8.780  | 8.450  | .375   | .545   | 8.000 |
| 164                | DB2-164P   | 8.880  | 8.550  | .375   | .545   | 8.100 |
| 166                | DB2-166P   | 8.980  | 8.650  | .375   | .545   | 8.200 |
| 168                | DB2-168P   | 9.080  | 8.750  | .375   | .545   | 8.300 |
| 170                | DB2-170P   | 9.180  | 8.850  | .375   | .545   | 8.400 |
| 172                | DB2-172P   | 9.280  | 8.950  | .375   | .545   | 8.500 |
| 174                | DB2-174P   | 9.380  | 9.050  | .375   | .545   | 8.600 |
| 176                | DB2-176P   | 9.480  | 9.150  | .375   | .545   | 8.700 |
| 178                | DB2-178P   | 9.580  | 9.250  | .375   | .545   | 8.800 |
| 180                | DB2-180P   | 9.680  | 9.350  | .375   | .545   | 8.900 |
| 182                | DB2-182P   | 9.780  | 9.450  | .375   | .545   | 9.000 |
| 184                | DB2-184P   | 9.880  | 9.550  | .375   | .545   | 9.100 |
| 186                | DB2-186P   | 9.980  | 9.650  | .375   | .545   | 9.200 |
| 188                | DB2-188P   | 10.080 | 9.750  | .375   | .545   | 9.300 |
| 190                | DB2-190P   | 10.180 | 9.850  | .375   | .545   | 9.400 |
| 192                | DB2-192P   | 10.280 | 9.950  | .375   | .545   | 9.500 |
| 194                | DB2-194P   | 10.380 | 10.050 | .375   | .545   | 9.600 |
| 196                | DB2-196P   | 10.480 | 10.150 | .375   | .545   | 9.700 |
| 198                | DB2-198P   | 10.580 | 10.250 | .375   | .545   | 9.800 |
| 200                | DB2-200P   | 10.680 | 10.350 | .375   | .545   | 9.900 |

\*See How to Order, pages 5, 6 and 7

# Low Mating Force

## daughter board connector

### 3 row contact arrangements

| Number of Contacts | DB Number* | A Max. | B     | C Max. | H Max. | AA    |
|--------------------|------------|--------|-------|--------|--------|-------|
| 030                | DB3-030P   | 1.680  | 1.350 | .475   | .645   | .900  |
| 033                | DB3-033P   | 1.780  | 1.450 | .475   | .645   | 1.000 |
| 036                | DB3-036P   | 1.880  | 1.550 | .475   | .645   | 1.100 |
| 039                | DB3-039P   | 1.980  | 1.650 | .475   | .645   | 1.200 |
| 042                | DB3-042P   | 2.080  | 1.750 | .475   | .645   | 1.300 |
| 045                | DB3-045P   | 2.180  | 1.850 | .475   | .645   | 1.400 |
| 048                | DB3-048P   | 2.280  | 1.950 | .475   | .645   | 1.500 |
| 051                | DB3-051P   | 2.380  | 2.050 | .475   | .645   | 1.600 |
| 054                | DB3-054P   | 2.480  | 2.150 | .475   | .645   | 1.700 |
| 057                | DB3-057P   | 2.580  | 2.250 | .475   | .645   | 1.800 |
| 060                | DB3-060P   | 2.680  | 2.350 | .475   | .645   | 1.900 |
| 063                | DB3-063P   | 2.780  | 2.450 | .475   | .645   | 2.000 |
| 066                | DB3-066P   | 2.880  | 2.550 | .475   | .645   | 2.100 |
| 069                | DB3-069P   | 2.980  | 2.650 | .475   | .645   | 2.200 |
| 072                | DB3-072P   | 3.080  | 2.750 | .475   | .645   | 2.300 |
| 075                | DB3-075P   | 3.180  | 2.850 | .475   | .645   | 2.400 |
| 078                | DB3-078P   | 3.280  | 2.950 | .475   | .645   | 2.500 |
| 081                | DB3-081P   | 3.380  | 3.050 | .475   | .645   | 2.600 |
| 084                | DB3-084P   | 3.480  | 3.150 | .475   | .645   | 2.700 |
| 087                | DB3-087P   | 3.580  | 3.250 | .475   | .645   | 2.800 |
| 090                | DB3-090P   | 3.680  | 3.350 | .475   | .645   | 2.900 |
| 093                | DB3-093P   | 3.780  | 3.450 | .475   | .645   | 3.000 |
| 096                | DB3-096P   | 3.880  | 3.550 | .475   | .645   | 3.100 |
| 099                | DB3-099P   | 3.980  | 3.650 | .475   | .645   | 3.200 |
| 102                | DB3-102P   | 4.080  | 3.750 | .475   | .645   | 3.300 |
| 105                | DB3-105P   | 4.180  | 3.850 | .475   | .645   | 3.400 |
| 108                | DB3-108P   | 4.280  | 3.950 | .475   | .645   | 3.500 |
| 111                | DB3-111P   | 4.380  | 4.050 | .475   | .645   | 3.600 |
| 114                | DB3-114P   | 4.480  | 4.150 | .475   | .645   | 3.700 |
| 117                | DB3-117P   | 4.580  | 4.250 | .475   | .645   | 3.800 |
| 120                | DB3-120P   | 4.680  | 4.350 | .475   | .645   | 3.900 |
| 123                | DB3-123P   | 4.780  | 4.450 | .475   | .645   | 4.000 |
| 126                | DB3-126P   | 4.880  | 4.550 | .475   | .645   | 4.100 |
| 129                | DB3-129P   | 4.980  | 4.650 | .475   | .645   | 4.200 |
| 132                | DB3-132P   | 5.080  | 4.750 | .475   | .645   | 4.300 |
| 135                | DB3-135P   | 5.180  | 4.850 | .475   | .645   | 4.400 |
| 138                | DB3-138P   | 5.280  | 4.950 | .475   | .645   | 4.500 |
| 141                | DB3-141P   | 5.380  | 5.050 | .475   | .645   | 4.600 |
| 144                | DB3-144P   | 5.480  | 5.150 | .475   | .645   | 4.700 |
| 147                | DB3-147P   | 5.580  | 5.250 | .475   | .645   | 4.800 |
| 150                | DB3-150P   | 5.680  | 5.350 | .475   | .645   | 4.900 |
| 153                | DB3-153P   | 5.780  | 5.450 | .475   | .645   | 5.000 |
| 156                | DB3-156P   | 5.880  | 5.550 | .475   | .645   | 5.100 |
| 159                | DB3-159P   | 5.980  | 5.650 | .475   | .645   | 5.200 |
| 162                | DB3-162P   | 6.080  | 5.750 | .475   | .645   | 5.300 |
| 165                | DB3-165P   | 6.180  | 5.850 | .475   | .645   | 5.400 |

| Number of Contacts | DB Number* | A Max. | B      | C Max. | H Max. | AA    |
|--------------------|------------|--------|--------|--------|--------|-------|
| 168                | DB3-168P   | 6.280  | 5.950  | .475   | .645   | 5.500 |
| 171                | DB3-171P   | 6.380  | 6.050  | .475   | .645   | 5.600 |
| 174                | DB3-174P   | 6.480  | 6.150  | .475   | .645   | 5.700 |
| 177                | DB3-177P   | 6.580  | 6.250  | .475   | .645   | 5.800 |
| 180                | DB3-180P   | 6.680  | 6.350  | .475   | .645   | 5.900 |
| 183                | DB3-183P   | 6.780  | 6.450  | .475   | .645   | 6.000 |
| 186                | DB3-186P   | 6.880  | 6.550  | .475   | .645   | 6.100 |
| 189                | DB3-189P   | 6.980  | 6.650  | .475   | .645   | 6.200 |
| 192                | DB3-192P   | 7.080  | 6.750  | .475   | .645   | 6.300 |
| 195                | DB3-195P   | 7.180  | 6.850  | .475   | .645   | 6.400 |
| 198                | DB3-198P   | 7.280  | 6.950  | .475   | .645   | 6.500 |
| 201                | DB3-201P   | 7.380  | 7.050  | .475   | .645   | 6.600 |
| 204                | DB3-204P   | 7.480  | 7.150  | .475   | .645   | 6.700 |
| 207                | DB3-207P   | 7.580  | 7.250  | .475   | .645   | 6.800 |
| 210                | DB3-210P   | 7.680  | 7.350  | .475   | .645   | 6.900 |
| 213                | DB3-213P   | 7.780  | 7.450  | .475   | .645   | 7.000 |
| 216                | DB3-216P   | 7.880  | 7.550  | .475   | .645   | 7.100 |
| 219                | DB3-219P   | 7.980  | 7.650  | .475   | .645   | 7.200 |
| 222                | DB3-222P   | 8.080  | 7.750  | .475   | .645   | 7.300 |
| 225                | DB3-225P   | 8.180  | 7.850  | .475   | .645   | 7.400 |
| 228                | DB3-228P   | 8.280  | 7.950  | .475   | .645   | 7.500 |
| 231                | DB3-231P   | 8.380  | 8.050  | .475   | .645   | 7.600 |
| 234                | DB3-234P   | 8.480  | 8.150  | .475   | .645   | 7.700 |
| 237                | DB3-237P   | 8.580  | 8.250  | .475   | .645   | 7.800 |
| 240                | DB3-240P   | 8.680  | 8.350  | .475   | .645   | 7.900 |
| 243                | DB3-243P   | 8.780  | 8.450  | .475   | .645   | 8.000 |
| 246                | DB3-246P   | 8.880  | 8.550  | .475   | .645   | 8.100 |
| 249                | DB3-249P   | 8.980  | 8.650  | .475   | .645   | 8.200 |
| 252                | DB3-252P   | 9.080  | 8.750  | .475   | .645   | 8.300 |
| 255                | DB3-255P   | 9.180  | 8.850  | .475   | .645   | 8.400 |
| 258                | DB3-258P   | 9.280  | 8.950  | .475   | .645   | 8.500 |
| 261                | DB3-261P   | 9.380  | 9.050  | .475   | .645   | 8.600 |
| 264                | DB3-264P   | 9.480  | 9.150  | .475   | .645   | 8.700 |
| 267                | DB3-267P   | 9.580  | 9.250  | .475   | .645   | 8.800 |
| 270                | DB3-270P   | 9.680  | 9.350  | .475   | .645   | 8.900 |
| 273                | DB3-273P   | 9.780  | 9.450  | .475   | .645   | 9.000 |
| 276                | DB3-276P   | 9.880  | 9.550  | .475   | .645   | 9.100 |
| 279                | DB3-279P   | 9.980  | 9.650  | .475   | .645   | 9.200 |
| 282                | DB3-282P   | 10.080 | 9.750  | .475   | .645   | 9.300 |
| 285                | DB3-285P   | 10.180 | 9.850  | .475   | .645   | 9.400 |
| 288                | DB3-288P   | 10.280 | 9.950  | .475   | .645   | 9.500 |
| 291                | DB3-291P   | 10.380 | 10.050 | .475   | .645   | 9.600 |
| 294                | DB3-294P   | 10.480 | 10.150 | .475   | .645   | 9.700 |
| 297                | DB3-397P   | 10.580 | 10.250 | .475   | .645   | 9.800 |
| 300                | DB3-300P   | 10.680 | 10.350 | .475   | .645   | 9.900 |

\*See How to Order, pages 5, 6 and 7

# Low Mating Force daughter board connector 4 row contact arrangements

| Number of Contacts | DB Number* | A Max. | B     | C Max. | H Max. | AA    |
|--------------------|------------|--------|-------|--------|--------|-------|
| 040                | DB4-040P   | 1.680  | 1.350 | .575   | .745   | .900  |
| 044                | DB4-044P   | 1.780  | 1.450 | .575   | .745   | 1.000 |
| 048                | DB4-048P   | 1.880  | 1.550 | .575   | .745   | 1.100 |
| 052                | DB4-052P   | 1.980  | 1.650 | .575   | .745   | 1.200 |
| 056                | DB4-056P   | 2.080  | 1.750 | .575   | .745   | 1.300 |
| 060                | DB4-060P   | 2.180  | 1.850 | .575   | .745   | 1.400 |
| 064                | DB4-064P   | 2.280  | 1.950 | .575   | .745   | 1.500 |
| 068                | DB4-068P   | 2.380  | 2.050 | .575   | .745   | 1.600 |
| 072                | DB4-072P   | 2.480  | 2.150 | .575   | .745   | 1.700 |
| 076                | DB4-076P   | 2.580  | 2.250 | .575   | .745   | 1.800 |
| 080                | DB4-080P   | 2.680  | 2.350 | .575   | .745   | 1.900 |
| 084                | DB4-084P   | 2.780  | 2.450 | .575   | .745   | 2.000 |
| 088                | DB4-088P   | 2.880  | 2.550 | .575   | .745   | 2.100 |
| 092                | DB4-092P   | 2.980  | 2.650 | .575   | .745   | 2.200 |
| 096                | DB4-096P   | 3.080  | 2.750 | .575   | .745   | 2.300 |
| 100                | DB4-100P   | 3.180  | 2.850 | .575   | .745   | 2.400 |
| 104                | DB4-104P   | 3.280  | 2.950 | .575   | .745   | 2.500 |
| 108                | DB4-108P   | 3.380  | 3.050 | .575   | .745   | 2.600 |
| 112                | DB4-112P   | 3.480  | 3.150 | .575   | .745   | 2.700 |
| 116                | DB4-116P   | 3.580  | 3.250 | .575   | .745   | 2.800 |
| 120                | DB4-120P   | 3.680  | 3.350 | .575   | .745   | 2.900 |
| 124                | DB4-124P   | 3.780  | 3.450 | .575   | .745   | 3.000 |
| 128                | DB4-128P   | 3.880  | 3.550 | .575   | .745   | 3.100 |
| 132                | DB4-132P   | 3.980  | 3.650 | .575   | .745   | 3.200 |
| 136                | DB4-136P   | 4.080  | 3.750 | .575   | .745   | 3.300 |
| 140                | DB4-140P   | 4.180  | 3.850 | .575   | .745   | 3.400 |
| 144                | DB4-144P   | 4.280  | 3.950 | .575   | .745   | 3.500 |
| 148                | DB4-148P   | 4.380  | 4.050 | .575   | .745   | 3.600 |
| 152                | DB4-152P   | 4.480  | 4.150 | .575   | .745   | 3.700 |
| 156                | DB4-156P   | 4.580  | 4.250 | .575   | .745   | 3.800 |
| 160                | DB4-160P   | 4.680  | 4.350 | .575   | .745   | 3.900 |
| 164                | DB4-164P   | 4.780  | 4.450 | .575   | .745   | 4.000 |
| 168                | DB4-168P   | 4.880  | 4.550 | .575   | .745   | 4.100 |
| 172                | DB4-172P   | 4.980  | 4.650 | .575   | .745   | 4.200 |
| 176                | DB4-176P   | 5.080  | 4.750 | .575   | .745   | 4.300 |
| 180                | DB4-180P   | 5.180  | 4.850 | .575   | .745   | 4.400 |
| 184                | DB4-184P   | 5.280  | 4.950 | .575   | .745   | 4.500 |
| 188                | DB4-188P   | 5.380  | 5.050 | .575   | .745   | 4.600 |
| 192                | DB4-192P   | 5.480  | 5.150 | .575   | .745   | 4.700 |
| 196                | DB4-196P   | 5.580  | 5.250 | .575   | .745   | 4.800 |
| 200                | DB4-200P   | 5.680  | 5.350 | .575   | .745   | 4.900 |
| 204                | DB4-204P   | 5.780  | 5.450 | .575   | .745   | 5.000 |
| 208                | DB4-208P   | 5.880  | 5.550 | .575   | .745   | 5.100 |
| 212                | DB4-212P   | 5.980  | 5.650 | .575   | .745   | 5.200 |
| 216                | DB4-216P   | 6.080  | 5.750 | .575   | .745   | 5.300 |
| 220                | DB4-220P   | 6.180  | 5.850 | .575   | .745   | 5.400 |

| Number of Contacts | DB Number* | A Max. | B      | C Max. | H Max. | AA    |
|--------------------|------------|--------|--------|--------|--------|-------|
| 224                | DB4-224P   | 6.280  | 5.950  | .575   | .745   | 5.500 |
| 228                | DB4-228P   | 6.380  | 6.050  | .575   | .745   | 5.600 |
| 232                | DB4-232P   | 6.480  | 6.150  | .575   | .745   | 5.700 |
| 236                | DB4-236P   | 6.580  | 6.250  | .575   | .745   | 5.800 |
| 240                | DB4-240P   | 6.680  | 6.350  | .575   | .745   | 5.900 |
| 244                | DB4-244P   | 6.780  | 6.450  | .575   | .745   | 6.000 |
| 248                | DB4-248P   | 6.880  | 6.550  | .575   | .745   | 6.100 |
| 252                | DB4-252P   | 6.980  | 6.650  | .575   | .745   | 6.200 |
| 256                | DB4-256P   | 7.080  | 6.750  | .575   | .745   | 6.300 |
| 260                | DB4-260P   | 7.180  | 6.850  | .575   | .745   | 6.400 |
| 264                | DB4-264P   | 7.280  | 6.950  | .575   | .745   | 6.500 |
| 268                | DB4-268P   | 7.380  | 7.050  | .575   | .745   | 6.600 |
| 272                | DB4-272P   | 7.480  | 7.150  | .575   | .745   | 6.700 |
| 276                | DB4-276P   | 7.580  | 7.250  | .575   | .745   | 6.800 |
| 280                | DB4-280P   | 7.680  | 7.350  | .575   | .745   | 6.900 |
| 284                | DB4-284P   | 7.780  | 7.450  | .575   | .745   | 7.000 |
| 288                | DB4-288P   | 7.780  | 7.550  | .575   | .745   | 7.100 |
| 292                | DB4-292P   | 7.980  | 7.650  | .575   | .745   | 7.200 |
| 296                | DB4-296P   | 8.080  | 7.750  | .575   | .745   | 7.300 |
| 300                | DB4-300P   | 8.180  | 7.850  | .575   | .745   | 7.400 |
| 304                | DB4-304P   | 8.280  | 7.950  | .575   | .745   | 7.500 |
| 308                | DB4-308P   | 8.380  | 8.050  | .575   | .745   | 7.600 |
| 312                | DB4-312P   | 8.480  | 8.150  | .575   | .745   | 7.700 |
| 316                | DB4-316P   | 8.580  | 8.250  | .575   | .745   | 7.800 |
| 320                | DB4-320P   | 8.680  | 8.350  | .575   | .745   | 7.900 |
| 324                | DB4-324P   | 8.780  | 8.450  | .575   | .745   | 8.000 |
| 328                | DB4-328P   | 8.880  | 8.550  | .575   | .745   | 8.100 |
| 332                | DB4-332P   | 8.980  | 8.650  | .575   | .745   | 8.200 |
| 336                | DB4-336P   | 9.080  | 8.750  | .575   | .745   | 8.300 |
| 340                | DB4-340P   | 9.180  | 8.850  | .575   | .745   | 8.400 |
| 344                | DB4-344P   | 9.280  | 8.950  | .575   | .745   | 8.500 |
| 348                | DB4-348P   | 9.380  | 9.050  | .575   | .745   | 8.600 |
| 352                | DB4-352P   | 9.480  | 9.150  | .575   | .745   | 8.700 |
| 356                | DB4-356P   | 9.580  | 9.250  | .575   | .745   | 8.800 |
| 360                | DB4-360P   | 9.680  | 9.350  | .575   | .745   | 8.900 |
| 364                | DB4-364P   | 9.780  | 9.450  | .575   | .745   | 9.000 |
| 368                | DB4-368P   | 9.880  | 9.550  | .575   | .745   | 9.100 |
| 372                | DB4-372P   | 9.980  | 9.650  | .575   | .745   | 9.200 |
| 376                | DB4-376P   | 10.080 | 9.750  | .575   | .745   | 9.300 |
| 380                | DB4-380P   | 10.180 | 9.850  | .575   | .745   | 9.400 |
| 384                | DB4-384P   | 10.280 | 9.950  | .575   | .745   | 9.500 |
| 388                | DB4-388P   | 10.380 | 10.050 | .575   | .745   | 9.600 |
| 392                | DB4-392P   | 10.480 | 10.150 | .575   | .745   | 9.700 |
| 396                | DB4-396P   | 10.580 | 10.250 | .575   | .745   | 9.800 |
| 400                | DB4-400P   | 10.680 | 10.350 | .575   | .745   | 9.900 |

\*See How to Order, pages 5, 6 and 7

# Low Mating Force input/output connector

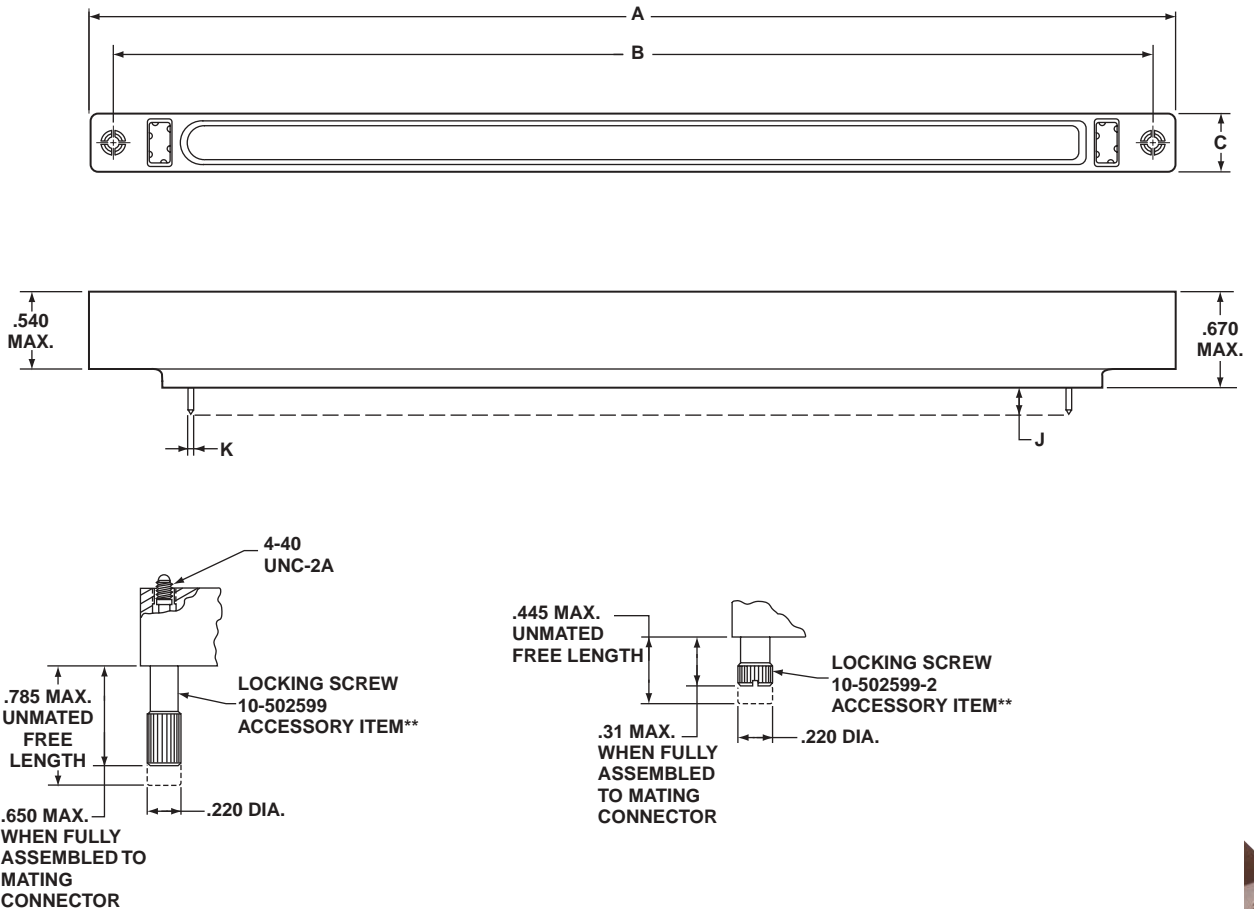

## MATES WITH MB AND PC SERIES CONNECTORS

### Notes:

When mating with MB or PC connector, a total of .022 inch minimum radial pilot is available for connector body alignment.

All dimensions for reference only.

Crimp contact 10-502588-1 (tin plate), wire well size 22D, supplied with IO Connector Series assemblies. Optional noble metal termination plating available. See How to Order, page 8.

Polarization keys are not supplied as part of IO Connector Series assemblies. See How to Order, page 7 and further description, page 28.

\*\* Locking Screws are not supplied as part of IO Connector Series assemblies. See How to Order, page 7 and further description, page 29.

| Description                       | Contact Data             |                     |            |            |
|-----------------------------------|--------------------------|---------------------|------------|------------|
|                                   | Termination Style Letter | Contact Part Number | J<br>±.020 | K<br>±.002 |
| Rear Removable Crimp Contact      | C                        | 10-502588-1         | N/A        | N/A        |
| Round PCB Stud Solder Termination | P                        | 10-502416-21        | .145       | .021       |
|                                   | P-(713)                  | 10-502416-31        | .060       | .021       |
|                                   | P-(709)                  | 10-502416-41        | .335       | .021       |

NOTE: Other variations available - see pages 7 and 8, or consult Sidney, NY.

# Low Mating Force input/output connector 2 row contact arrangements

| Number of Contacts | IO Number* | A Max. | B     | C Max. |
|--------------------|------------|--------|-------|--------|
| 020                | IO2-020(*) | 2.295  | 1.975 | .390   |
| 022                | IO2-022(*) | 2.395  | 2.075 | .390   |
| 024                | IO2-024(*) | 2.495  | 2.175 | .390   |
| 026                | IO2-026(*) | 2.595  | 2.275 | .390   |
| 028                | IO2-028(*) | 2.695  | 2.375 | .390   |
| 030                | IO2-030(*) | 2.795  | 2.475 | .390   |
| 032                | IO2-032(*) | 2.895  | 2.575 | .390   |
| 034                | IO2-034(*) | 2.995  | 2.675 | .390   |
| 036                | IO2-036(*) | 3.095  | 2.775 | .390   |
| 038                | IO2-038(*) | 3.195  | 2.875 | .390   |
| 040                | IO2-040(*) | 3.295  | 2.975 | .390   |
| 042                | IO2-042(*) | 3.395  | 3.075 | .390   |
| 044                | IO2-044(*) | 3.495  | 3.175 | .390   |
| 046                | IO2-046(*) | 3.595  | 3.275 | .390   |
| 048                | IO2-048(*) | 3.695  | 3.375 | .390   |
| 050                | IO2-050(*) | 3.795  | 3.475 | .390   |
| 052                | IO2-052(*) | 3.895  | 3.575 | .390   |
| 054                | IO2-054(*) | 3.995  | 3.675 | .390   |
| 056                | IO2-056(*) | 4.095  | 3.775 | .390   |
| 058                | IO2-058(*) | 4.195  | 3.875 | .390   |
| 060                | IO2-060(*) | 4.295  | 3.975 | .390   |
| 062                | IO2-062(*) | 4.395  | 4.075 | .390   |
| 064                | IO2-064(*) | 4.495  | 4.175 | .390   |
| 066                | IO2-066(*) | 4.595  | 4.275 | .390   |
| 068                | IO2-068(*) | 4.695  | 4.375 | .390   |
| 070                | IO2-070(*) | 4.795  | 4.475 | .390   |
| 072                | IO2-072(*) | 4.895  | 4.575 | .390   |
| 074                | IO2-074(*) | 4.995  | 4.675 | .390   |
| 076                | IO2-076(*) | 5.095  | 4.775 | .390   |
| 078                | IO2-078(*) | 5.195  | 4.875 | .390   |
| 080                | IO2-080(*) | 5.295  | 4.975 | .390   |
| 082                | IO2-082(*) | 5.395  | 5.075 | .390   |
| 084                | IO2-084(*) | 5.495  | 5.175 | .390   |
| 086                | IO2-086(*) | 5.595  | 5.275 | .390   |
| 088                | IO2-088(*) | 5.695  | 5.375 | .390   |
| 090                | IO2-090(*) | 5.795  | 5.475 | .390   |
| 092                | IO2-092(*) | 5.895  | 5.575 | .390   |
| 094                | IO2-094(*) | 5.995  | 5.675 | .390   |
| 096                | IO2-096(*) | 6.095  | 5.775 | .390   |
| 098                | IO2-098(*) | 6.195  | 5.875 | .390   |
| 100                | IO2-100(*) | 6.295  | 5.975 | .390   |
| 102                | IO2-102(*) | 6.395  | 6.075 | .390   |
| 104                | IO2-104(*) | 6.495  | 6.175 | .390   |
| 106                | IO2-106(*) | 6.595  | 6.275 | .390   |
| 108                | IO2-108(*) | 6.695  | 6.375 | .390   |
| 110                | IO2-110(*) | 6.795  | 6.475 | .390   |

| Number of Contacts | IO Number* | A Max. | B      | C Max. |
|--------------------|------------|--------|--------|--------|
| 112                | IO2-112(*) | 6.895  | 6.575  | .390   |
| 114                | IO2-114(*) | 6.995  | 6.675  | .390   |
| 116                | IO2-116(*) | 7.095  | 6.775  | .390   |
| 118                | IO2-118(*) | 7.195  | 6.875  | .390   |
| 120                | IO2-120(*) | 7.295  | 6.975  | .390   |
| 122                | IO2-122(*) | 7.395  | 7.075  | .390   |
| 124                | IO2-124(*) | 7.495  | 7.175  | .390   |
| 126                | IO2-126(*) | 7.595  | 7.275  | .390   |
| 128                | IO2-128(*) | 7.695  | 7.375  | .390   |
| 130                | IO2-130(*) | 7.795  | 7.475  | .390   |
| 132                | IO2-132(*) | 7.895  | 7.575  | .390   |
| 134                | IO2-134(*) | 7.995  | 7.675  | .390   |
| 136                | IO2-136(*) | 8.095  | 7.775  | .390   |
| 138                | IO2-138(*) | 8.195  | 7.875  | .390   |
| 140                | IO2-140(*) | 8.295  | 7.975  | .390   |
| 142                | IO2-142(*) | 8.395  | 8.075  | .390   |
| 144                | IO2-144(*) | 8.495  | 8.175  | .390   |
| 146                | IO2-146(*) | 8.595  | 8.275  | .390   |
| 148                | IO2-148(*) | 8.695  | 8.375  | .390   |
| 150                | IO2-150(*) | 8.795  | 8.475  | .390   |
| 152                | IO2-152(*) | 8.895  | 8.575  | .390   |
| 154                | IO2-154(*) | 8.995  | 8.675  | .390   |
| 156                | IO2-156(*) | 9.095  | 8.775  | .390   |
| 158                | IO2-158(*) | 9.195  | 8.875  | .390   |
| 160                | IO2-160(*) | 9.295  | 8.975  | .390   |
| 162                | IO2-162(*) | 9.395  | 9.075  | .390   |
| 164                | IO2-164(*) | 9.495  | 9.175  | .390   |
| 166                | IO2-166(*) | 9.595  | 9.275  | .390   |
| 168                | IO2-168(*) | 9.695  | 9.375  | .390   |
| 170                | IO2-170(*) | 9.795  | 9.475  | .390   |
| 172                | IO2-172(*) | 9.895  | 9.575  | .390   |
| 174                | IO2-174(*) | 9.995  | 9.675  | .390   |
| 176                | IO2-176(*) | 10.095 | 9.775  | .390   |
| 178                | IO2-178(*) | 10.195 | 9.875  | .390   |
| 180                | IO2-180(*) | 10.295 | 9.975  | .390   |
| 182                | IO2-182(*) | 10.395 | 10.075 | .390   |
| 184                | IO2-184(*) | 10.495 | 10.175 | .390   |
| 186                | IO2-186(*) | 10.595 | 10.275 | .390   |
| 188                | IO2-188(*) | 10.695 | 10.375 | .390   |
| 190                | IO2-190(*) | 10.795 | 10.475 | .390   |
| 192                | IO2-192(*) | 10.895 | 10.575 | .390   |
| 194                | IO2-194(*) | 10.995 | 10.675 | .390   |
| 196                | IO2-196(*) | 11.095 | 10.775 | .390   |
| 198                | IO2-198(*) | 11.195 | 10.875 | .390   |
| 200                | IO2-200(*) | 11.295 | 10.975 | .390   |

\*See How to Order, pages 5, 6 and 7

# Low Mating Force input/output connector 3 row contact arrangements

| Number of Contacts | IO Number* | A Max. | B     | C Max. |
|--------------------|------------|--------|-------|--------|
| 030                | IO3-030(*) | 2.295  | 1.975 | .490   |
| 033                | IO3-033(*) | 2.395  | 2.075 | .490   |
| 036                | IO3-036(*) | 2.495  | 2.175 | .490   |
| 039                | IO3-039(*) | 2.595  | 2.275 | .490   |
| 042                | IO3-042(*) | 2.695  | 2.375 | .490   |
| 045                | IO3-045(*) | 2.795  | 2.475 | .490   |
| 048                | IO3-048(*) | 2.894  | 2.575 | .490   |
| 051                | IO3-051(*) | 2.995  | 2.675 | .490   |
| 054                | IO3-054(*) | 3.095  | 2.775 | .490   |
| 057                | IO3-057(*) | 3.195  | 2.875 | .490   |
| 060                | IO3-060(*) | 3.295  | 2.975 | .490   |
| 063                | IO3-063(*) | 3.395  | 3.075 | .490   |
| 066                | IO3-066(*) | 3.495  | 3.175 | .490   |
| 069                | IO3-069(*) | 3.595  | 3.275 | .490   |
| 072                | IO3-072(*) | 3.695  | 3.375 | .490   |
| 075                | IO3-075(*) | 3.795  | 3.475 | .490   |
| 078                | IO3-078(*) | 3.895  | 3.575 | .490   |
| 081                | IO3-081(*) | 3.995  | 3.675 | .490   |
| 084                | IO3-084(*) | 4.095  | 3.775 | .490   |
| 087                | IO3-087(*) | 4.195  | 3.875 | .490   |
| 090                | IO3-090(*) | 4.295  | 3.975 | .490   |
| 093                | IO3-093(*) | 4.395  | 4.075 | .490   |
| 096                | IO3-096(*) | 4.495  | 4.175 | .490   |
| 099                | IO3-099(*) | 4.595  | 4.275 | .490   |
| 102                | IO3-102(*) | 4.695  | 4.375 | .490   |
| 105                | IO3-105(*) | 4.795  | 4.475 | .490   |
| 108                | IO3-108(*) | 4.895  | 4.575 | .490   |
| 111                | IO3-111(*) | 4.995  | 4.675 | .490   |
| 114                | IO3-114(*) | 5.095  | 4.775 | .490   |
| 117                | IO3-117(*) | 5.195  | 4.875 | .490   |
| 120                | IO3-120(*) | 5.295  | 4.975 | .490   |
| 123                | IO3-123(*) | 5.395  | 5.075 | .490   |
| 126                | IO3-126(*) | 5.495  | 5.175 | .490   |
| 129                | IO3-129(*) | 5.595  | 5.275 | .490   |
| 132                | IO3-132(*) | 5.695  | 5.375 | .490   |
| 135                | IO3-135(*) | 5.795  | 5.475 | .490   |
| 138                | IO3-138(*) | 5.895  | 5.575 | .490   |
| 141                | IO3-141(*) | 5.995  | 5.675 | .490   |
| 144                | IO3-144(*) | 6.095  | 5.775 | .490   |
| 147                | IO3-147(*) | 6.195  | 5.875 | .490   |
| 150                | IO3-150(*) | 6.295  | 5.975 | .490   |
| 153                | IO3-153(*) | 6.395  | 6.075 | .490   |
| 156                | IO3-156(*) | 6.495  | 6.175 | .490   |
| 159                | IO3-159(*) | 6.595  | 6.275 | .490   |
| 162                | IO3-162(*) | 6.695  | 6.375 | .490   |
| 165                | IO3-165(*) | 6.795  | 6.475 | .490   |

| Number of Contacts | IO Number* | A Max. | B      | C Max. |
|--------------------|------------|--------|--------|--------|
| 168                | IO3-168(*) | 6.895  | 6.575  | .490   |
| 171                | IO3-171(*) | 6.995  | 6.675  | .490   |
| 174                | IO3-174(*) | 7.095  | 6.775  | .490   |
| 177                | IO3-177(*) | 7.195  | 6.875  | .490   |
| 180                | IO3-180(*) | 7.295  | 6.975  | .490   |
| 183                | IO3-183(*) | 7.395  | 7.075  | .490   |
| 186                | IO3-186(*) | 7.495  | 7.175  | .490   |
| 189                | IO3-189(*) | 7.595  | 7.275  | .490   |
| 192                | IO3-192(*) | 7.695  | 7.375  | .490   |
| 195                | IO3-195(*) | 7.795  | 7.475  | .490   |
| 198                | IO3-198(*) | 7.895  | 7.575  | .490   |
| 201                | IO3-201(*) | 7.995  | 7.675  | .490   |
| 204                | IO3-204(*) | 8.095  | 7.775  | .490   |
| 207                | IO3-207(*) | 8.195  | 7.875  | .490   |
| 210                | IO3-210(*) | 8.295  | 7.975  | .490   |
| 213                | IO3-213(*) | 8.395  | 8.075  | .490   |
| 216                | IO3-216(*) | 8.495  | 8.175  | .490   |
| 219                | IO3-219(*) | 8.595  | 8.275  | .490   |
| 222                | IO3-222(*) | 8.695  | 8.375  | .490   |
| 225                | IO3-225(*) | 8.795  | 8.475  | .490   |
| 228                | IO3-228(*) | 8.895  | 8.575  | .490   |
| 231                | IO3-231(*) | 8.995  | 8.675  | .490   |
| 234                | IO3-234(*) | 9.095  | 8.775  | .490   |
| 237                | IO3-237(*) | 9.195  | 8.875  | .490   |
| 240                | IO3-240(*) | 9.295  | 8.975  | .490   |
| 243                | IO3-243(*) | 9.395  | 9.075  | .490   |
| 246                | IO3-246(*) | 9.495  | 9.175  | .490   |
| 249                | IO3-249(*) | 9.595  | 9.275  | .490   |
| 252                | IO3-252(*) | 9.695  | 9.375  | .490   |
| 255                | IO3-255(*) | 9.795  | 9.475  | .490   |
| 258                | IO3-258(*) | 9.895  | 9.575  | .490   |
| 261                | IO3-261(*) | 9.995  | 9.675  | .490   |
| 264                | IO3-264(*) | 10.095 | 9.775  | .490   |
| 267                | IO3-267(*) | 10.195 | 9.875  | .490   |
| 270                | IO3-270(*) | 10.295 | 9.975  | .490   |
| 273                | IO3-273(*) | 10.395 | 10.075 | .490   |
| 276                | IO3-276(*) | 10.495 | 10.175 | .490   |
| 279                | IO3-279(*) | 10.595 | 10.275 | .490   |
| 282                | IO3-282(*) | 10.695 | 10.375 | .490   |
| 285                | IO3-285(*) | 10.795 | 10.475 | .490   |
| 288                | IO3-288(*) | 10.895 | 10.575 | .490   |
| 291                | IO3-291(*) | 10.995 | 10.675 | .490   |
| 294                | IO3-294(*) | 11.095 | 10.775 | .490   |
| 297                | IO3-297(*) | 11.195 | 10.875 | .490   |
| 300                | IO3-300(*) | 11.295 | 10.975 | .490   |

\*See How to Order, pages 5, 6 and 7



# Low Mating Force input/output connector 4 row contact arrangements

| Number of Contacts | IO Number* | A Max. | B     | C Max. |
|--------------------|------------|--------|-------|--------|
| 040                | IO4-040(*) | 2.295  | 1.975 | .590   |
| 044                | IO4-044(*) | 2.395  | 2.075 | .590   |
| 048                | IO4-048(*) | 2.495  | 2.175 | .590   |
| 052                | IO4-052(*) | 2.595  | 2.275 | .590   |
| 056                | IO4-056(*) | 2.695  | 2.375 | .590   |
| 060                | IO4-060(*) | 2.795  | 2.475 | .590   |
| 064                | IO4-064(*) | 2.895  | 2.575 | .590   |
| 068                | IO4-068(*) | 2.995  | 2.675 | .590   |
| 072                | IO4-072(*) | 3.095  | 2.775 | .590   |
| 076                | IO4-076(*) | 3.195  | 2.875 | .590   |
| 080                | IO4-080(*) | 3.295  | 2.975 | .590   |
| 084                | IO4-084(*) | 3.395  | 3.075 | .590   |
| 088                | IO4-088(*) | 3.495  | 3.175 | .590   |
| 092                | IO4-092(*) | 3.595  | 3.275 | .590   |
| 096                | IO4-096(*) | 3.695  | 3.375 | .590   |
| 100                | IO4-100(*) | 3.795  | 3.475 | .590   |
| 104                | IO4-104(*) | 3.895  | 3.575 | .590   |
| 108                | IO4-108(*) | 3.995  | 3.675 | .590   |
| 112                | IO4-112(*) | 4.095  | 3.775 | .590   |
| 116                | IO4-116(*) | 4.195  | 3.875 | .590   |
| 120                | IO4-120(*) | 4.295  | 3.975 | .590   |
| 124                | IO4-124(*) | 4.395  | 4.075 | .590   |
| 128                | IO4-128(*) | 4.495  | 4.175 | .590   |
| 132                | IO4-132(*) | 4.595  | 4.275 | .590   |
| 136                | IO4-136(*) | 4.695  | 4.375 | .590   |
| 140                | IO4-140(*) | 4.795  | 4.475 | .590   |
| 144                | IO4-144(*) | 4.895  | 4.575 | .590   |
| 148                | IO4-148(*) | 4.995  | 4.675 | .590   |
| 152                | IO4-152(*) | 5.095  | 4.775 | .590   |
| 156                | IO4-156(*) | 5.195  | 4.875 | .590   |
| 160                | IO4-160(*) | 5.295  | 4.975 | .590   |
| 164                | IO4-164(*) | 5.395  | 5.075 | .590   |
| 168                | IO4-168(*) | 5.495  | 5.175 | .590   |
| 172                | IO4-172(*) | 5.595  | 5.275 | .590   |
| 176                | IO4-176(*) | 5.695  | 5.375 | .590   |
| 180                | IO4-180(*) | 5.795  | 5.475 | .590   |
| 184                | IO4-184(*) | 5.895  | 5.575 | .590   |
| 188                | IO4-188(*) | 5.995  | 5.675 | .590   |
| 192                | IO4-192(*) | 6.095  | 5.775 | .590   |
| 196                | IO4-196(*) | 6.195  | 5.875 | .590   |
| 200                | IO4-200(*) | 6.295  | 5.975 | .590   |
| 204                | IO4-204(*) | 6.395  | 6.075 | .590   |
| 208                | IO4-208(*) | 6.495  | 6.175 | .590   |
| 212                | IO4-212(*) | 6.595  | 6.275 | .590   |
| 216                | IO4-216(*) | 6.695  | 6.375 | .590   |
| 220                | IO4-220(*) | 6.795  | 6.475 | .590   |

| Number of Contacts | IO Number* | A Max. | B      | C Max. |
|--------------------|------------|--------|--------|--------|
| 224                | IO4-224(*) | 6.895  | 6.575  | .590   |
| 228                | IO4-228(*) | 6.995  | 6.675  | .590   |
| 232                | IO4-232(*) | 7.095  | 6.775  | .590   |
| 236                | IO4-236(*) | 7.195  | 6.875  | .590   |
| 240                | IO4-240(*) | 7.295  | 6.975  | .590   |
| 244                | IO4-244(*) | 7.395  | 7.075  | .590   |
| 248                | IO4-248(*) | 7.495  | 7.175  | .590   |
| 252                | IO4-252(*) | 7.595  | 7.275  | .590   |
| 256                | IO4-256(*) | 7.695  | 7.375  | .590   |
| 260                | IO4-260(*) | 7.795  | 7.475  | .590   |
| 264                | IO4-264(*) | 7.895  | 7.575  | .590   |
| 268                | IO4-268(*) | 7.995  | 7.675  | .590   |
| 272                | IO4-272(*) | 8.095  | 7.775  | .590   |
| 276                | IO4-276(*) | 8.195  | 7.875  | .590   |
| 280                | IO4-280(*) | 8.295  | 7.975  | .590   |
| 284                | IO4-284(*) | 8.395  | 8.075  | .590   |
| 288                | IO4-288(*) | 8.495  | 8.175  | .590   |
| 292                | IO4-292(*) | 8.595  | 8.275  | .590   |
| 296                | IO4-296(*) | 8.695  | 8.375  | .590   |
| 300                | IO4-300(*) | 8.795  | 8.475  | .590   |
| 304                | IO4-304(*) | 8.895  | 8.575  | .590   |
| 308                | IO4-308(*) | 8.995  | 8.675  | .590   |
| 312                | IO4-312(*) | 9.095  | 8.775  | .590   |
| 316                | IO4-316(*) | 9.195  | 8.875  | .590   |
| 320                | IO4-320(*) | 9.295  | 8.975  | .590   |
| 324                | IO4-324(*) | 9.395  | 9.075  | .590   |
| 328                | IO4-328(*) | 9.496  | 9.175  | .590   |
| 332                | IO4-332(*) | 9.595  | 9.275  | .590   |
| 336                | IO4-336(*) | 9.695  | 9.375  | .590   |
| 340                | IO4-340(*) | 9.795  | 9.475  | .590   |
| 344                | IO4-344(*) | 9.895  | 9.575  | .590   |
| 348                | IO4-348(*) | 9.995  | 9.675  | .590   |
| 352                | IO4-352(*) | 10.095 | 9.775  | .590   |
| 356                | IO4-356(*) | 10.195 | 9.875  | .590   |
| 360                | IO4-360(*) | 10.295 | 9.975  | .590   |
| 364                | IO4-364(*) | 10.395 | 10.075 | .590   |
| 368                | IO4-368(*) | 10.495 | 10.175 | .590   |
| 372                | IO4-372(*) | 10.595 | 10.275 | .590   |
| 376                | IO4-376(*) | 10.695 | 10.375 | .590   |
| 380                | IO4-380(*) | 10.795 | 10.475 | .590   |
| 384                | IO4-384(*) | 10.895 | 10.575 | .590   |
| 388                | IO4-388(*) | 10.995 | 10.675 | .590   |
| 392                | IO4-392(*) | 11.095 | 10.775 | .590   |
| 396                | IO4-396(*) | 11.195 | 10.875 | .590   |
| 400                | IO4-400(*) | 11.295 | 10.975 | .590   |

\*See How to Order, pages 5, 6 and 7



# Low Mating Force PC connector 2 row contact arrangements

| Number of Contacts | PC Number* | A Max. | B     | C Max. |
|--------------------|------------|--------|-------|--------|
| 020                | PC2-020P   | 2.295  | 1.975 | .390   |
| 022                | PC2-022P   | 2.395  | 2.075 | .390   |
| 024                | PC2-024P   | 2.495  | 2.175 | .390   |
| 026                | PC2-026P   | 2.595  | 2.275 | .390   |
| 028                | PC2-028P   | 2.695  | 2.375 | .390   |
| 030                | PC2-030P   | 2.795  | 2.475 | .390   |
| 032                | PC2-032P   | 2.895  | 2.575 | .390   |
| 034                | PC2-034P   | 2.995  | 2.675 | .390   |
| 036                | PC2-036P   | 3.095  | 2.775 | .390   |
| 038                | PC2-038P   | 3.195  | 2.875 | .390   |
| 040                | PC2-040P   | 3.295  | 2.975 | .390   |
| 042                | PC2-042P   | 3.395  | 3.075 | .390   |
| 044                | PC2-044P   | 3.495  | 3.175 | .390   |
| 046                | PC2-046P   | 3.595  | 3.275 | .390   |
| 048                | PC2-048P   | 3.695  | 3.375 | .390   |
| 050                | PC2-050P   | 3.795  | 3.475 | .390   |
| 052                | PC2-052P   | 3.895  | 3.575 | .390   |
| 054                | PC2-054P   | 3.995  | 3.675 | .390   |
| 056                | PC2-056P   | 4.095  | 3.775 | .390   |
| 058                | PC2-058P   | 4.195  | 3.875 | .390   |
| 060                | PC2-060P   | 4.295  | 3.975 | .390   |
| 062                | PC2-062P   | 4.395  | 4.075 | .390   |
| 064                | PC2-064P   | 4.495  | 4.175 | .390   |
| 066                | PC2-066P   | 4.595  | 4.275 | .390   |
| 068                | PC2-068P   | 4.695  | 4.375 | .390   |
| 070                | PC2-070P   | 4.795  | 4.475 | .390   |
| 072                | PC2-072P   | 4.895  | 4.575 | .390   |
| 074                | PC2-074P   | 4.995  | 4.675 | .390   |
| 076                | PC2-076P   | 5.095  | 4.775 | .390   |
| 078                | PC2-078P   | 5.195  | 4.875 | .390   |
| 080                | PC2-080P   | 5.295  | 4.975 | .390   |
| 082                | PC2-082P   | 5.395  | 5.075 | .390   |
| 084                | PC2-084P   | 5.495  | 5.175 | .390   |
| 086                | PC2-086P   | 5.595  | 5.275 | .390   |
| 088                | PC2-088P   | 5.695  | 5.375 | .390   |
| 090                | PC2-090P   | 5.795  | 5.475 | .390   |
| 092                | PC2-092P   | 5.895  | 5.575 | .390   |
| 094                | PC2-094P   | 5.995  | 5.675 | .390   |
| 096                | PC2-096P   | 6.095  | 5.775 | .390   |
| 098                | PC2-098P   | 6.195  | 5.875 | .390   |
| 100                | PC2-100P   | 6.295  | 5.975 | .390   |
| 102                | PC2-102P   | 6.395  | 6.075 | .390   |
| 104                | PC2-104P   | 6.495  | 6.175 | .390   |
| 106                | PC2-106P   | 6.595  | 6.275 | .390   |
| 108                | PC2-108P   | 6.695  | 6.375 | .390   |
| 110                | PC2-110P   | 6.795  | 6.475 | .390   |

| Number of Contacts | PC Number* | A Max. | B      | C Max. |
|--------------------|------------|--------|--------|--------|
| 112                | PC2-112P   | 6.895  | 6.575  | .390   |
| 114                | PC2-114P   | 6.995  | 6.675  | .390   |
| 116                | PC2-116P   | 7.095  | 6.775  | .390   |
| 118                | PC2-118P   | 7.195  | 6.875  | .390   |
| 120                | PC2-120P   | 7.295  | 6.975  | .390   |
| 122                | PC2-122P   | 7.395  | 7.075  | .390   |
| 124                | PC2-124P   | 7.495  | 7.175  | .390   |
| 126                | PC2-126P   | 7.595  | 7.275  | .390   |
| 128                | PC2-128P   | 7.695  | 7.375  | .390   |
| 130                | PC2-130P   | 7.795  | 7.475  | .390   |
| 132                | PC2-132P   | 7.895  | 7.575  | .390   |
| 134                | PC2-134P   | 7.995  | 7.675  | .390   |
| 136                | PC2-136P   | 8.095  | 7.775  | .390   |
| 138                | PC2-138P   | 8.195  | 7.875  | .390   |
| 140                | PC2-140P   | 8.295  | 7.975  | .390   |
| 142                | PC2-142P   | 8.395  | 8.075  | .390   |
| 144                | PC2-144P   | 8.495  | 8.175  | .390   |
| 146                | PC2-146P   | 8.595  | 8.275  | .390   |
| 148                | PC2-148P   | 8.695  | 8.375  | .390   |
| 150                | PC2-150P   | 8.795  | 8.475  | .390   |
| 152                | PC2-152P   | 8.895  | 8.575  | .390   |
| 154                | PC2-154P   | 8.995  | 8.675  | .390   |
| 156                | PC2-156P   | 9.095  | 8.775  | .390   |
| 158                | PC2-158P   | 9.195  | 8.875  | .390   |
| 160                | PC2-160P   | 9.295  | 8.975  | .390   |
| 162                | PC2-162P   | 9.395  | 9.075  | .390   |
| 164                | PC2-164P   | 9.495  | 9.175  | .390   |
| 166                | PC2-166P   | 9.595  | 9.275  | .390   |
| 168                | PC2-168P   | 9.695  | 9.375  | .390   |
| 170                | PC2-170P   | 9.795  | 9.475  | .390   |
| 172                | PC2-172P   | 9.895  | 9.575  | .390   |
| 174                | PC2-174P   | 9.995  | 9.675  | .390   |
| 176                | PC2-176P   | 10.095 | 9.775  | .390   |
| 178                | PC2-178P   | 10.195 | 9.875  | .390   |
| 180                | PC2-180P   | 10.295 | 9.975  | .390   |
| 182                | PC2-182P   | 10.395 | 10.075 | .390   |
| 184                | PC2-184P   | 10.495 | 10.175 | .390   |
| 186                | PC2-186P   | 10.595 | 10.275 | .390   |
| 188                | PC2-188P   | 10.695 | 10.375 | .390   |
| 190                | PC2-190P   | 10.795 | 10.475 | .390   |
| 192                | PC2-192P   | 10.895 | 10.575 | .390   |
| 194                | PC2-194P   | 10.995 | 10.675 | .390   |
| 196                | PC2-196P   | 11.095 | 10.775 | .390   |
| 198                | PC2-198P   | 11.195 | 10.875 | .390   |
| 200                | PC2-200P   | 11.295 | 10.975 | .390   |

\*See How to Order, pages 5, 6 and 7

# Low Mating Force PC connector 3 row contact arrangements

| Number of Contacts | PC Number* | A Max. | B     | C Max. |
|--------------------|------------|--------|-------|--------|
| 030                | PC3-030P   | 2.295  | 1.975 | .490   |
| 033                | PC3-033P   | 2.395  | 2.075 | .490   |
| 036                | PC3-036P   | 2.495  | 2.175 | .490   |
| 039                | PC3-039P   | 2.595  | 2.275 | .490   |
| 042                | PC3-042P   | 2.695  | 2.375 | .490   |
| 045                | PC3-045P   | 2.795  | 2.475 | .490   |
| 048                | PC3-048P   | 2.895  | 2.575 | .490   |
| 051                | PC3-051P   | 2.995  | 2.675 | .490   |
| 054                | PC3-054P   | 3.095  | 2.775 | .490   |
| 057                | PC3-057P   | 3.195  | 2.875 | .490   |
| 060                | PC3-060P   | 3.295  | 2.975 | .490   |
| 063                | PC3-063P   | 3.395  | 3.075 | .490   |
| 066                | PC3-066P   | 3.495  | 3.175 | .490   |
| 069                | PC3-069P   | 3.595  | 3.275 | .490   |
| 072                | PC3-072P   | 3.695  | 3.375 | .490   |
| 075                | PC3-075P   | 3.795  | 3.475 | .490   |
| 078                | PC3-078P   | 3.895  | 3.575 | .490   |
| 081                | PC3-081P   | 3.995  | 3.675 | .490   |
| 084                | PC3-084P   | 4.095  | 3.775 | .490   |
| 087                | PC3-087P   | 4.195  | 3.875 | .490   |
| 090                | PC3-090P   | 4.295  | 3.975 | .490   |
| 093                | PC3-093P   | 4.395  | 4.075 | .490   |
| 096                | PC3-096P   | 4.495  | 4.175 | .490   |
| 099                | PC3-099P   | 4.595  | 4.275 | .490   |
| 102                | PC3-102P   | 4.695  | 4.375 | .490   |
| 105                | PC3-105P   | 4.795  | 4.475 | .490   |
| 108                | PC3-108P   | 4.895  | 4.575 | .490   |
| 111                | PC3-111P   | 4.995  | 4.675 | .490   |
| 114                | PC3-114P   | 5.095  | 4.775 | .490   |
| 117                | PC3-117P   | 5.195  | 4.875 | .490   |
| 120                | PC3-120P   | 5.295  | 4.975 | .490   |
| 123                | PC3-123P   | 5.395  | 5.075 | .490   |
| 126                | PC3-126P   | 5.495  | 5.175 | .490   |
| 129                | PC3-129P   | 5.595  | 5.275 | .490   |
| 132                | PC3-132P   | 5.695  | 5.375 | .490   |
| 135                | PC3-135P   | 5.795  | 5.475 | .490   |
| 138                | PC3-138P   | 5.895  | 5.575 | .490   |
| 141                | PC3-141P   | 5.995  | 5.675 | .490   |
| 144                | PC3-144P   | 6.095  | 5.775 | .490   |
| 147                | PC3-147P   | 6.195  | 5.875 | .490   |
| 150                | PC3-150P   | 6.295  | 5.975 | .490   |
| 153                | PC3-153P   | 6.395  | 6.075 | .490   |
| 156                | PC3-156P   | 6.495  | 6.175 | .490   |
| 159                | PC3-159P   | 6.595  | 6.275 | .490   |
| 162                | PC3-162P   | 6.695  | 6.375 | .490   |
| 165                | PC3-165P   | 6.795  | 6.475 | .490   |

| Number of Contacts | PC Number* | A Max. | B      | C Max. |
|--------------------|------------|--------|--------|--------|
| 168                | PC3-168P   | 6.895  | 6.575  | .490   |
| 171                | PC3-171P   | 6.995  | 6.675  | .490   |
| 174                | PC3-174P   | 7.095  | 6.775  | .490   |
| 177                | PC3-177P   | 7.195  | 6.875  | .490   |
| 180                | PC3-180P   | 7.295  | 6.975  | .490   |
| 183                | PC3-183P   | 7.395  | 7.075  | .490   |
| 186                | PC3-186P   | 7.495  | 7.175  | .490   |
| 189                | PC3-189P   | 7.595  | 7.275  | .490   |
| 192                | PC3-192P   | 7.695  | 7.375  | .490   |
| 195                | PC3-195P   | 7.795  | 7.475  | .490   |
| 198                | PC3-198P   | 7.895  | 7.575  | .490   |
| 201                | PC3-201P   | 7.995  | 7.675  | .490   |
| 204                | PC3-204P   | 8.095  | 7.775  | .490   |
| 207                | PC3-207P   | 8.195  | 7.875  | .490   |
| 210                | PC3-210P   | 8.295  | 7.975  | .490   |
| 213                | PC3-213P   | 8.395  | 8.075  | .490   |
| 216                | PC3-216P   | 8.495  | 8.175  | .490   |
| 219                | PC3-219P   | 8.595  | 8.275  | .490   |
| 222                | PC3-222P   | 8.695  | 8.375  | .490   |
| 225                | PC3-225P   | 8.795  | 8.475  | .490   |
| 228                | PC3-228P   | 8.895  | 8.575  | .490   |
| 231                | PC3-231P   | 8.995  | 8.675  | .490   |
| 234                | PC3-234P   | 9.095  | 8.775  | .490   |
| 237                | PC3-237P   | 9.195  | 8.875  | .490   |
| 240                | PC3-240P   | 9.295  | 8.975  | .490   |
| 243                | PC3-243P   | 9.395  | 9.075  | .490   |
| 246                | PC3-246P   | 9.495  | 9.175  | .490   |
| 249                | PC3-249P   | 9.595  | 9.275  | .490   |
| 252                | PC3-252P   | 9.695  | 9.375  | .490   |
| 255                | PC3-255P   | 9.795  | 9.475  | .490   |
| 258                | PC3-258P   | 9.895  | 9.575  | .490   |
| 261                | PC3-261P   | 9.995  | 9.675  | .490   |
| 264                | PC3-264P   | 10.095 | 9.775  | .490   |
| 267                | PC3-267P   | 10.195 | 9.875  | .490   |
| 270                | PC3-270P   | 10.295 | 9.975  | .490   |
| 273                | PC3-273P   | 10.395 | 10.075 | .490   |
| 276                | PC3-276P   | 10.495 | 10.175 | .490   |
| 279                | PC3-279P   | 10.595 | 10.275 | .490   |
| 282                | PC3-282P   | 10.695 | 10.375 | .490   |
| 285                | PC3-285P   | 10.795 | 10.475 | .490   |
| 288                | PC3-288P   | 10.895 | 10.575 | .490   |
| 291                | PC3-291P   | 10.995 | 10.675 | .490   |
| 294                | PC3-294P   | 11.095 | 10.775 | .490   |
| 297                | PC3-297P   | 11.195 | 10.875 | .490   |
| 300                | PC3-300P   | 11.295 | 10.975 | .490   |

\*See How to Order, pages 5, 6 and 7

# Low Mating Force PC connector 4 row contact arrangements

| Number of Contacts | PC Number* | A Max. | B     | C Max. |
|--------------------|------------|--------|-------|--------|
| 040                | PC4-040P   | 2.295  | 1.975 | .590   |
| 044                | PC4-044P   | 2.395  | 2.075 | .590   |
| 048                | PC4-048P   | 2.495  | 2.175 | .590   |
| 052                | PC4-052P   | 2.595  | 2.275 | .590   |
| 056                | PC4-056P   | 2.695  | 2.375 | .590   |
| 060                | PC4-060P   | 2.795  | 2.475 | .590   |
| 064                | PC4-064P   | 2.895  | 2.575 | .590   |
| 068                | PC4-068P   | 2.995  | 2.675 | .590   |
| 072                | PC4-072P   | 3.095  | 2.775 | .590   |
| 076                | PC4-076P   | 3.195  | 2.875 | .590   |
| 080                | PC4-080P   | 3.295  | 2.975 | .590   |
| 084                | PC4-084P   | 3.395  | 3.075 | .590   |
| 088                | PC4-088P   | 3.495  | 3.175 | .590   |
| 092                | PC4-092P   | 3.595  | 3.275 | .590   |
| 096                | PC4-096P   | 3.695  | 3.375 | .590   |
| 100                | PC4-100P   | 3.795  | 3.475 | .590   |
| 104                | PC4-104P   | 3.895  | 3.575 | .590   |
| 108                | PC4-108P   | 3.995  | 3.675 | .590   |
| 112                | PC4-112P   | 4.095  | 3.775 | .590   |
| 116                | PC4-116P   | 4.195  | 3.875 | .590   |
| 120                | PC4-120P   | 4.295  | 3.975 | .590   |
| 124                | PC4-124P   | 4.395  | 4.075 | .590   |
| 128                | PC4-128P   | 4.495  | 4.175 | .590   |
| 132                | PC4-132P   | 4.595  | 4.275 | .590   |
| 136                | PC4-136P   | 4.695  | 4.375 | .590   |
| 140                | PC4-140P   | 4.795  | 4.475 | .590   |
| 144                | PC4-144P   | 4.895  | 4.575 | .590   |
| 148                | PC4-148P   | 4.995  | 4.675 | .590   |
| 152                | PC4-152P   | 5.095  | 4.775 | .590   |
| 156                | PC4-156P   | 5.195  | 4.875 | .590   |
| 160                | PC4-160P   | 5.295  | 4.975 | .590   |
| 164                | PC4-164P   | 5.395  | 5.075 | .590   |
| 168                | PC4-168P   | 5.495  | 5.175 | .590   |
| 172                | PC4-172P   | 5.595  | 5.275 | .590   |
| 176                | PC4-176P   | 5.695  | 5.375 | .590   |
| 180                | PC4-180P   | 5.795  | 5.475 | .590   |
| 184                | PC4-184P   | 5.895  | 5.575 | .590   |
| 188                | PC4-188P   | 5.995  | 5.675 | .590   |
| 192                | PC4-192P   | 6.095  | 5.775 | .590   |
| 196                | PC4-196P   | 6.195  | 5.875 | .590   |
| 200                | PC4-200P   | 6.295  | 5.975 | .590   |
| 204                | PC4-204P   | 6.395  | 6.075 | .590   |
| 208                | PC4-208P   | 6.495  | 6.175 | .590   |
| 212                | PC4-212P   | 6.595  | 6.275 | .590   |
| 216                | PC4-216P   | 6.695  | 6.375 | .590   |
| 220                | PC4-220P   | 6.795  | 6.475 | .590   |

| Number of Contacts | PC Number* | A Max. | B      | C Max. |
|--------------------|------------|--------|--------|--------|
| 224                | PC4-224P   | 6.895  | 6.575  | .590   |
| 228                | PC4-228P   | 6.995  | 6.675  | .590   |
| 232                | PC4-232P   | 7.095  | 6.775  | .590   |
| 236                | PC4-236P   | 7.195  | 6.875  | .590   |
| 240                | PC4-240P   | 7.295  | 6.975  | .590   |
| 244                | PC4-244P   | 7.395  | 7.075  | .590   |
| 248                | PC4-248P   | 7.495  | 7.175  | .590   |
| 252                | PC4-252P   | 7.595  | 7.275  | .590   |
| 256                | PC4-256P   | 7.695  | 7.375  | .590   |
| 260                | PC4-260P   | 7.795  | 7.475  | .590   |
| 264                | PC4-264P   | 7.895  | 7.575  | .590   |
| 268                | PC4-268P   | 7.995  | 7.675  | .590   |
| 272                | PC4-272P   | 8.095  | 7.775  | .590   |
| 276                | PC4-276P   | 8.195  | 7.875  | .590   |
| 280                | PC4-280P   | 8.295  | 7.975  | .590   |
| 284                | PC4-284P   | 8.395  | 8.075  | .590   |
| 288                | PC4-288P   | 8.495  | 8.175  | .590   |
| 292                | PC4-292P   | 8.595  | 8.275  | .590   |
| 296                | PC4-296P   | 8.695  | 8.375  | .590   |
| 300                | PC4-300P   | 8.795  | 8.475  | .590   |
| 304                | PC4-304P   | 8.895  | 8.575  | .590   |
| 308                | PC4-308P   | 8.995  | 8.675  | .590   |
| 312                | PC4-312P   | 9.095  | 8.775  | .590   |
| 316                | PC4-316P   | 9.195  | 8.875  | .590   |
| 320                | PC4-320P   | 9.295  | 8.975  | .590   |
| 324                | PC4-324P   | 9.395  | 9.075  | .590   |
| 328                | PC4-328P   | 9.495  | 9.175  | .590   |
| 332                | PC4-332P   | 9.595  | 9.275  | .590   |
| 336                | PC4-336P   | 9.695  | 9.375  | .590   |
| 340                | PC4-340P   | 9.795  | 9.475  | .590   |
| 344                | PC4-344P   | 9.895  | 9.575  | .590   |
| 348                | PC4-348P   | 9.995  | 9.675  | .590   |
| 352                | PC4-352P   | 10.095 | 9.775  | .590   |
| 356                | PC4-356P   | 10.195 | 9.875  | .590   |
| 360                | PC4-360P   | 10.295 | 9.975  | .590   |
| 364                | PC4-364P   | 10.395 | 10.075 | .590   |
| 368                | PC4-368P   | 10.495 | 10.175 | .590   |
| 372                | PC4-372P   | 10.595 | 10.275 | .590   |
| 376                | PC4-376P   | 10.695 | 10.375 | .590   |
| 380                | PC4-380P   | 10.795 | 10.475 | .590   |
| 384                | PC4-384P   | 10.895 | 10.575 | .590   |
| 388                | PC4-388P   | 10.995 | 10.675 | .590   |
| 392                | PC4-392P   | 11.095 | 10.775 | .590   |
| 396                | PC4-396P   | 11.195 | 10.875 | .590   |
| 400                | PC4-400P   | 11.295 | 10.975 | .590   |

\*See How to Order, pages 5, 6 and 7

# Low Mating Force — accessories

## polarization keys

Polarization Keys, 10-285422-2 are accessory items, ordered separately for MB, DB, IO and PC Series Low Mating Force Connectors. If used, 4 keys are required per connector half. See page 7 for ordering information.

Examples below show key locations for mating connector halves. The number or letter designations on all mating connectors are arranged so that the projecting keys on one relate to the same numbers or letters on the other. With the numbers or letters matching, the connector will mate.

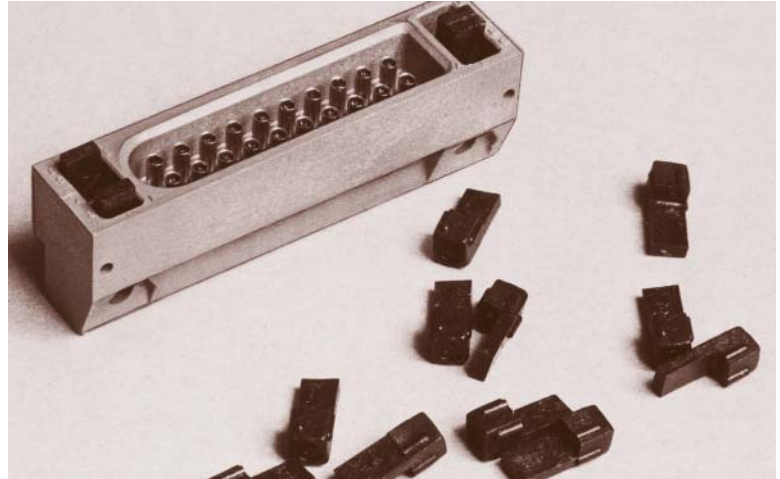

### TYPICAL CODE SEQUENCE

B, H-1, 5

4 Different possibilities  
at each position = 256

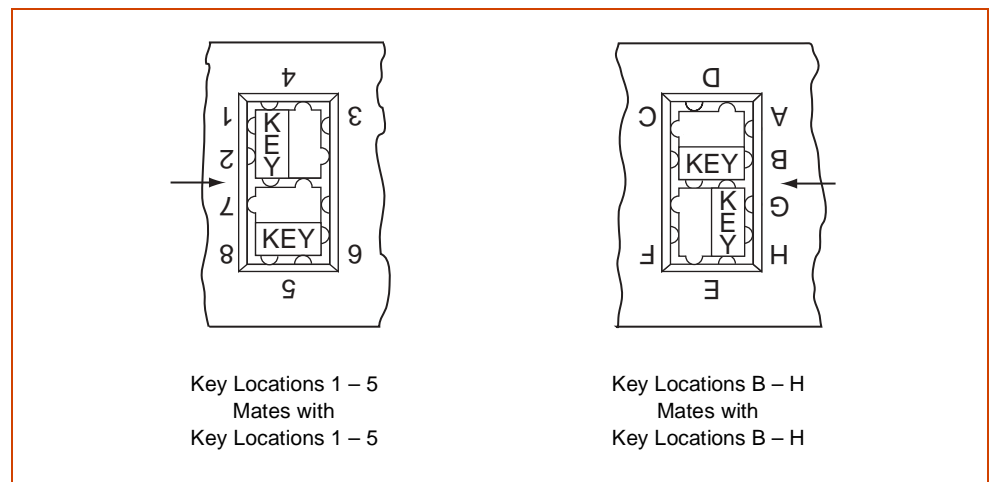

KEY LOCATIONS - MOTHER BOARD OR PC CONNECTORS

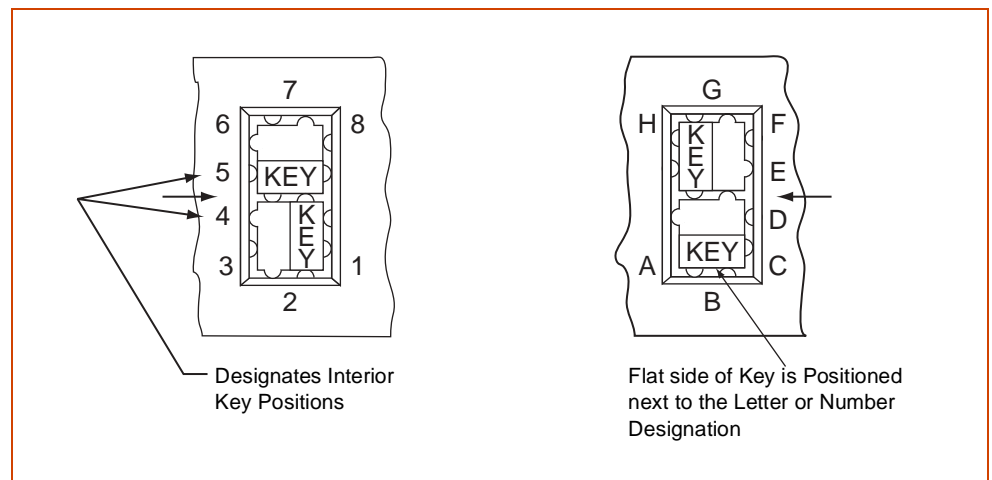

KEY LOCATIONS - DAUGHTER BOARD OR INPUT/OUTPUT CONNECTORS

# Low Mating Force — accessories\*\* mounting applications

## INPUT/OUTPUT CONNECTOR

Locking screw accessory 10-502599\*, two per connector, may be inserted into the large holes at each end of the back of an IO connector body. By hand, press the locking screw firmly down into the cavity until it reaches a positive stop. The locking screw is then captivated in the retention system of the cavity. Should it be necessary to remove the captivated locking screw accessory, push the screw as far forward as possible. Using vise grip pliers to grasp the threaded end and pliers to hold the knurled end, apply torque until the locking screw breaks in two. Each half will then drop out.

The front of the locking screw has a 4-40 UNC-2A THD which will mate with the locking bushing accessories of MB or PC connectors.

## PC CONNECTOR

Locking bushing accessory 10-411196-4\*, two per connector, may be inserted from the back of a PC connector body into large mounting holes at each end. The 0.126 inch diameter cross holes in the locking bushing must be aligned with the 0.126 inch diameter cross hole in the PC connector body. These holes accept a 4-40 UNC-2A screw which should be long enough to allow mounting to the board. Fasten with a suitable washer and nut, making sure an appropriate washer is also under the head.

The front of the locking bushing has a 4-40 UNC-2B THD which will mate with the locking bushing accessory of an IO connector.

## MOTHER BOARD CONNECTOR

Locking/mounting bushing accessory 10-411196-3\*, two per connector, may be inserted into 0.185 inch diameter CSK holes at each end of the front of a MB connector body. Using a light arbor press or similar device, firmly press the knurled section of the bushing into the lower 0.122 inch diameter hole until the front of the bushing is flush with, or slightly below, the front surface of the MB connector. Make sure the bushing and hole axis are properly aligned. Avoid excessive force which may crack the back surface of the MB connector body.

The back of the locking/mounting bushing has a 4-40 UNC-2A THD to mount the connector. Fasten the connector with a suitable washer and nut.

The front of the locking/mounting bushing has a 4-40 UNC-2B THD which will mate with the locking screw accessory of an IO connector.

### Alternate Mounting Variations for Mother Board Connector

1. A clinch nut (such as all ESNA 79NCFMA2-26 or equivalent) may be pressed from the front, knurled end first, through the 0.185 diameter CSK into the 0.122 inch diameter hole at each end of the connector. An appropriate length 2-56 UNC-3A screw, washer, and nut may be used to mount the connector. Mounting forces should be applied to the bushing toward the rear of the connector.

2. When a Daughter Board is mated use a 4-40 screw of appropriate length, with a suitable washer under the head. Insert the screw from the front of the connector through the 0.185 inch diameter CSK into the 0.122 inch diameter hole at each end of the connector and fasten with a suitable washer and nut.

For ordering information, see page 7.  
\*\*See L-1220 for additional information

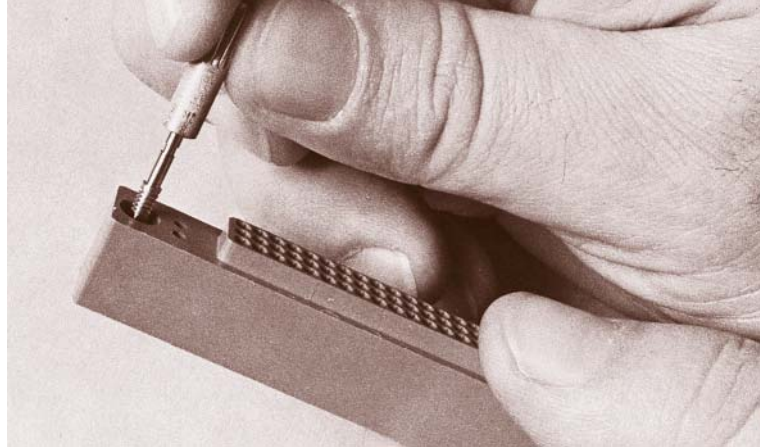

LOCKING SCREW ACCESSORY INSERTED INTO IO CONNECTOR BODY



LOCKING BUSHING ACCESSORY INSERTED INTO PC CONNECTOR BODY



LOCKING/MOUNTING BUSHING ACCESSORY INSERTED INTO MB CONNECTOR BODY

# Low Mating Force — accessories

## test probe kit

In order to insure that contacts are properly wired within a connector, a Test probe Kit (11-10400-22)\* is needed. This kit is especially designed to prevent damage to brush contacts during probing. It consists of a plastic holder, insert, and two contacts, usable for either Mother Board or Daughter Board applications. It is recommended that the user buy two kits, if using connectors of two genders. The kits are not convertible after assembly.

### Instructions:

**DB-IO Test Probe -** Slide the insert back over the wire and crimp contact on. Follow crimping procedure below. Then snap the insert and contact assembly into the holder.

**MB-PC Test probe -** Slide holder over wire and then crimp contact. Follow crimping procedure below. Slide the insert on the contact and seat it against the shoulder. Slide the holder forward and snap it onto the insert.

**Crimping Procedure:** Using accepted industry procedures, strip wire end to be terminated 1/8 to 5/32 inch. Care should be taken not to nick wire strands. Assemble the M22520/2-01 crimp tool and the M22520/2-27 positioner, and place tool selector in correct setting for wire size. Selected wire size must not have an insulation diameter more than .062 for MB-PC and not more than .038 for DB/IO.

|     |    |    |    |    |
|-----|----|----|----|----|
| AWG | 22 | 24 | 26 | 28 |
| SEL | 5  | 4  | 3  | 2  |

Insert stripped wire end into contact wire well. Strands should be visible in wire well inspection hole. Bottom contact and wire assembly in positioner, and close handles of crimp tool to complete crimp. Handles will not open unless full crimping cycle has been completed.

\*For ordering information, see page 7.

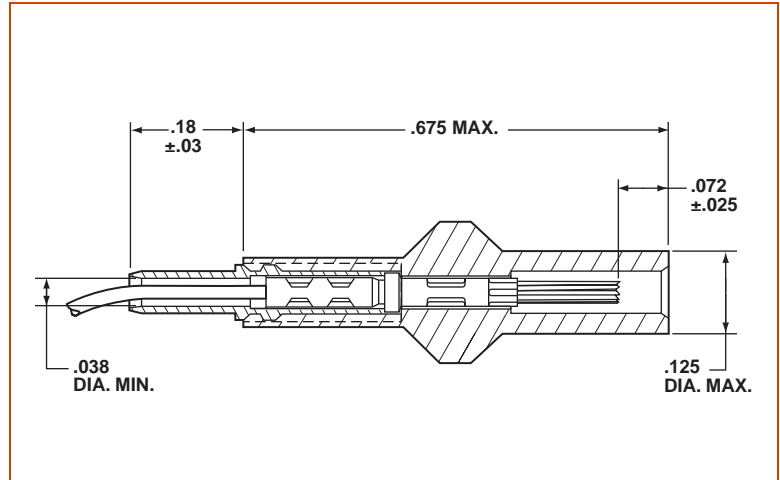

DAUGHTER BOARD - INPUT/OUTPUT TEST PROBE

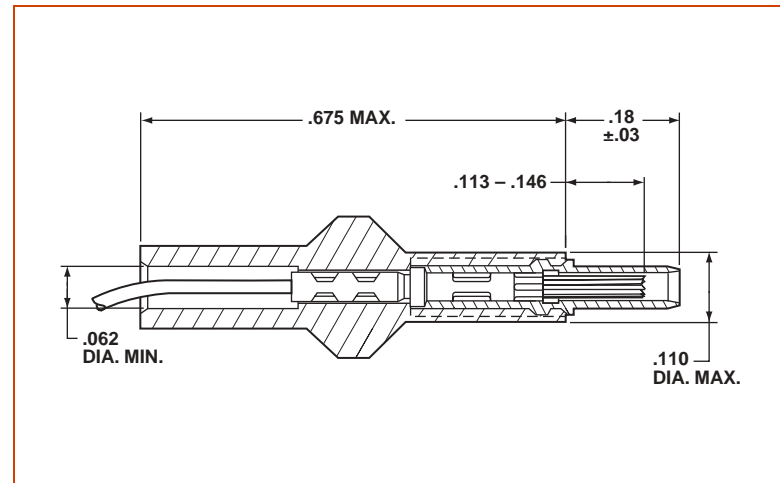

MOTHER BOARD - PC TEST PROBE



# LRM Surface Mount Connectors with MIL-C-55302 Bristle® Brush® Contacts

Amphenol® LRM Surface Mount Connectors offer high performance and high contact density in a low insertion force PCB connector for today's integrated avionics packaging requirements.

Designed to meet the high density needs of today's integrated electronic modules, this surface mount connector uses the Brush® contact which has been proven in military avionics packages, is qualified to MIL-C-55302, and is the consensus choice for integrated avionics systems.

## LRM Connector advantages include:

- **Low mating and unmating forces**
  - Smooth, low friction interfaces
  - 70% to 90% reduction in mating/unmating forces from conventional pin-socket contacts
- **Proven durability and long contact life**
  - Over 20,000 cycles of mating and unmating without performance degradation
  - Documented intermittency-free performance - no 10 nano second discontinuities during 50m cycles of 0.010 displacement
  - Overall cost effectiveness (reduced life cycle costs through extended service life)
- **Multiple points of contact provide superior electrical characteristics**
  - 14-70 points of contact per mated contact
  - Stable, low resistance
  - Redundant current paths
  - Proven electrical and gas tight contact sites
- **Surface/straddle mount module connectors; backplane connectors available with through-hole solder posts or compliant pins for solderless applications**

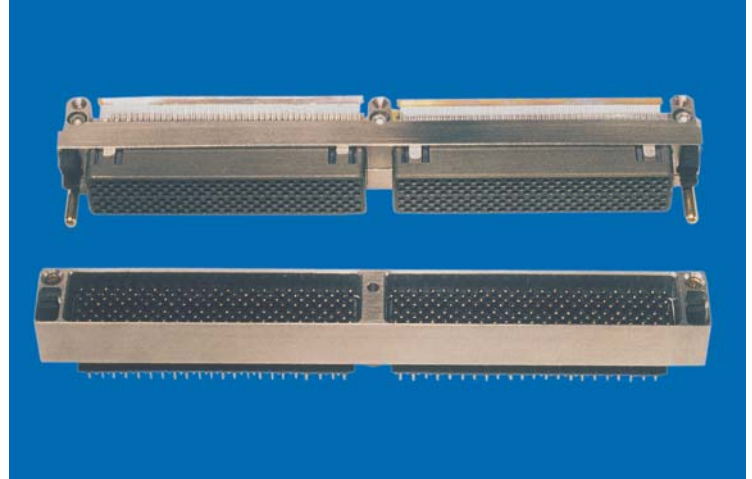

STAGGERED GRID, 360 CONTACTS LRM PATTERN



GEN-X GRID, 472 CONTACTS LRM PATTERN

Amphenol® LRM surface mount connectors are offered in configurations with up to 472 contacts in a SEM-E format and include ESD protection using the Faraday Cage principal. More contacts can be added to accommodate other formats. Other products available in the family are:

- RF module connectors for LRM applications requiring blind mate, radio frequency capability
- High-voltage inserts for LRM power supply applications designed to control the effects of high voltage at altitude
- Fiber optic configurations for high speed secure communications

For more information on surface mount connectors ask for L-2104 LRM Reference Guide, and/or L-2081 LRM User's Guide (contains engineering drawings). Consult Amphenol, Sidney, NY or your nearest Amphenol sales office.