

Tous droits strictement réservés. Reproduction ou communication à des tiers sans autorisation écrite du propriétaire. Property of FCJ. Droits de reproduction FCJ.

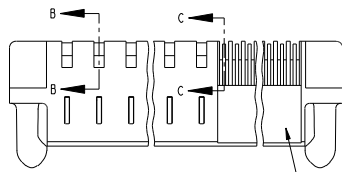

All rights strictly reserved. Reproduction or issue to third parties in any form or by any means without written authority from the proprietor. Property of FCJ. Copyright FCJ.

PRODUCT NUMBER  
51761- A00CCDDEF...  
NOTE 1  
SEE NOTE 1



SEE NOTE 9

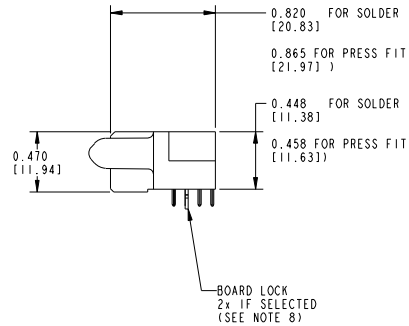
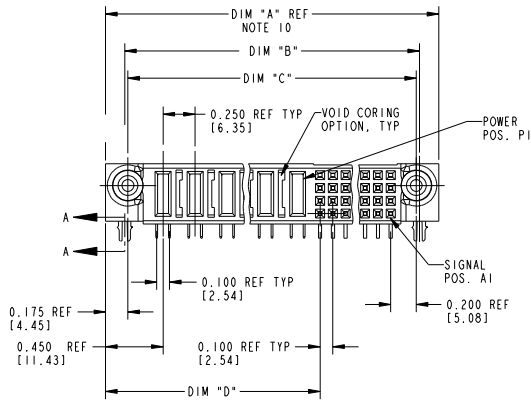

THIS FILE WAS ORIGINALLY CREATED IN THE PRO ENGINEER ENVIRONMENT AND ANY FUTURE REVISIONS TO THIS FILE MUST BE MADE IN THE PRO ENGINEER ENVIRONMENT

mat'l code SEE NOTE 2				tolerances unless otherwise specified		CUSTOMER	FCJ	www.fciconnect.com
lfr	ecn no.	dr	date	linear	.XX±.01/.X±.3	COPY	projection	title
E	0607-0059	BTAM	02/12/07		.XXX±.005/.XX±.13			RIGHT ANGLE RECEPTACLE w/GUIDE PIN
L	0607-0061	JUL14	02/14/07		.XXXX±.0020/.XXX±.051			SIGNAL/ POWER
M	0608-0239	JC	09/11/08	angles	0°±.2°			product family
N	0609-0120	JW	04/23/09	dr		INCH / MM		PWRBLADE
				eng	J. BROWN 05-18-99	scale	1:1	code
				chr	J. BROWN 05-18-99			213
				appd	J. BROWN 05-18-99			SHEET
sheet	revision	N	N	N				1 OF 3
index	sheet	1	2	3				

form no. 7530-001-I03

cage code 22526

PDM: Rev:N

STATUS:Released

Printed: Dec 20, 2010

Tous droits strictement réservés. Reproduction ou communication à des tiers sans autorisation écrite du propriétaire. Property of FCJ. Droit de reproduction FCJ.



All rights strictly reserved. Reproduction or issue to third parties in any form or by any means without written authority from the proprietor. Property of FCJ. Copyright FCJ.

PRODUCT NUMBER
51761-A00CCDDEF... NOTE 1
SEE NOTE 1

DIM	LENGTH FORMULAS (SEE NOTE 10)
DIM "A"	.250 [6.35] x DD + .100 [2.54] x (CCC/4) + .650 [16.51] (NOTE 10)
DIM "B"	.250 [6.35] x DD + .100 [2.54] x (CCC/4) + .350 [8.89]
DIM "C"	.250 [6.35] x DD + .100 [2.54] x (CCC/4) + .300 [7.62]
DIM "D"	.250 [6.35] x DD + .375 [9.35]
DIM "F"	.250 [6.35] x DD + .100 [2.54] x (CCC/4) + .680 [17.27]
DIM "G"	.250 [6.35] x DD + .225 [5.72]

CONNECTOR NOTES

- PRODUCT NUMBER CODE:  
51761 - A 00 CCC DD E F LF  
NO THIS SUFFIX: 100u"/2.54um SnPb ON PCB INTERFACE  
ADD THIS SUFFIX: 78u"/2.00um Sn ON PCB INTERFACE  
RETENTION TO PCB (NOTE 8)  
TAIL OPTIONS (NOTE 7)  
NUMBER OF LEFT END POWER CONTACTS (NOTE 6)  
NUMBER OF SIGNAL CONTACTS (NOTE 5)  
ALWAYS '00' (ZERO, ZERO) (NOTE 4)  
PLATING (NOTE 3)  
BASE NUMBER
- HOUSING MATERIAL: GLASS FILLED V-O HIGH TEMP THERMO PLASTIC.  
SIGNAL CONTACT MATERIAL: COPPER ALLOY  
POWER CONTACT MATERIAL: COPPER ALLOY
- PLATING OPTION:  
SEE PRINT 10064183 FOR PLATING SPEC OF 51761-100CCDDEF; 51761-100CCDDEF LF
- THIS PART IS NOT AVAILABLE WITH RIGHT SIDE POWER CONTACTS.
- SIGNAL CONTACTS, 004 TO 148 AVAILABLE FOR SOLDER TO BOARD.  
012 TO 148 AVAILABLE FOR PRESS FIT TO BOARD.
- LEFT END POWER CONTACTS, 01 TO 20 AVAILABLE.  
MAXIMUM OF 20 POWER CONTACTS PER CONNECTOR
- TAIL OPTIONS:  
A = .135 ± .010 [3.43 ± 0.25] SOLDER TO BOARD  
B = .090 ± .005 / -.010 [2.29 +0.13 / -0.25] SOLDER TO BOARD  
C = .154 ± .010 [3.91 ± 0.25] PRESS FIT TO BOARD
- RETENTION TO PCB OPTIONS:  
A = BOARD LOCK (REQUIRES .098 ± .002 / -.001 [2.49 +0.05 / -0.03] THRU HOLE IN PCB MOUNTING FOOT HEIGHT: .220 [5.59])  
B = .150 [3.81] THRU HOLE (REQUIRES .158 ± 0.003 [4.01 ± 0.08] THRU HOLE IN PCB). MOUNTING FOOT HEIGHT .160 [4.06]
- MANUFACTURE'S NAME, P/N, AND DATE CODE TO APPEAR ON THIS SURFACE.
- THE MAXIMUM OVERALL LENGTH (DIM A) OF A PART IS 8.00 [203.2]
- PRODUCT SPECIFICATION GS-12-149
- APPLICATION SPECIFICATION BUS-20-067.
- FOR PRESS FIT CONNECTORS USE FCJ CAM TOOL 430140-XXX TO APPLY CONNECTOR TO IPCB.

PCB NOTES:

- ALL DIMENSIONS ARE BASIC UNLESS OTHERWISE SPECIFIED.
- ALL THROUGH HOLES ARE LOCATED WITH A TRUE POSITION OF .004 [0.10]
- ALL HOLE DIAMETERS ARE FINISHED HOLE SIZE.
- Ø 0.0453 ± .001 [1.151 ± 0.02] DRILLED HOLES PLATED WITH 0.0003 [0.007] MIN SnPb OR Sn OVER 0.001 [0.03] TO .003 [0.08] Cu PLATING TO ACHIEVE A .040 ± .003 [1.02 ± 0.08] HOLE.
- A SYMBOL WILL BE NEXT TO ANY DIMENSION, VIEW, OR NOTE WHICH HAS BEEN MODIFIED WITH THE CURRENT DRAWING REVISION.

THIS FILE WAS ORIGINALLY CREATED IN THE PRO ENGINEER ENVIRONMENT AND ANY FUTURE REVISIONS TO THIS FILE MUST BE MADE IN THE PRO ENGINEER ENVIRONMENT

mat'l code		tolerances unless otherwise specified		CUSTOMER COPY		FCJ www.fcjconnect.com	
ltr	ecm no.	dr	date	linear	projection	title	
N				.XX±.01/.X±.3 .XXX±.005/.X±.13 .XXX±.0020/.XXX±.051	⊕	RIGHT ANGLE RECEPTACLE w/GUIDE PIN SIGNAL / POWER	
				angles	⊕	product family	code
				Ø	INCH / MM	PWRBLADE	213
				dr	scale	size	SHEET
				eng	1:1	51761	2 OF 3
				chr			
				appd			
sheet index	revision sheet						

form no. 7530-001-I03

cage code 22526

PDM: Rev:N

STATUS:Released

Printed: Dec 20, 2010

Tous droits strictement réservés. Reproduction ou communication à des tiers sans autorisation écrite du propriétaire. Property of FCJ. Droit de reproduction FCJ.



All rights strictly reserved. Reproduction or issue to third parties in any form or by any means without written authority from the proprietor. Property of FCJ. Copyright FCJ.

PRODUCT NUMBER  
51761 - A00CCDDEF --  
NOTE ①

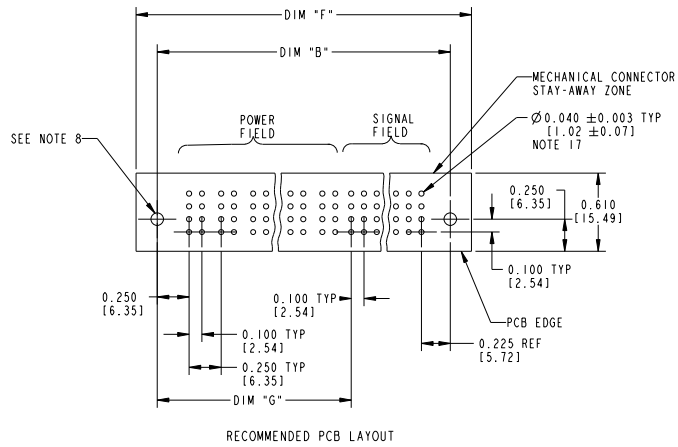
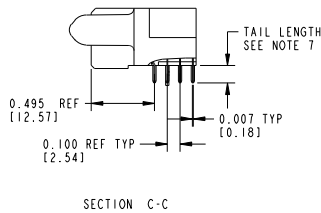
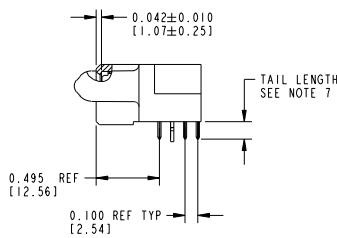
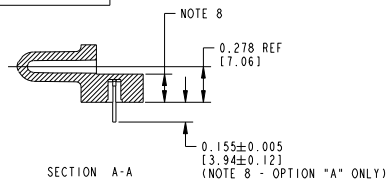

mat'l code				tolerances unless otherwise specified		CUSTOMER		FCJ		www.fcjconnect.com	
lfr	ecm no.	dr	date	linear	.XX±.01/.X±.3	projection		COPY		title	
N				angles	.XXX±.005/.XX±.13	INCH / MM		A		RIGHT ANGLE RECEPTACLE w/GUIDE PIN SIGNAL / POWER	
				dr	.XXX±.0020/.XX±.051	scale		1:1		product family	
				eng	0°±2°	size		A		PWRBLADE	
				chr		code		213		size	
				appd		dwg no		51761		SHEET	
sheet	revision					code		22526		3 OF 3	
index	sheet										

form no. 7530-001-103

cage code 22526

PDM: Rev:N

STATUS:Released

Printed: Dec 20, 2010