

Tous droits strictement réservés. Reproduction ou communication à des tiers sans autorisation écrite du propriétaire. Property of FCJ. Droit de reproduction FCJ.

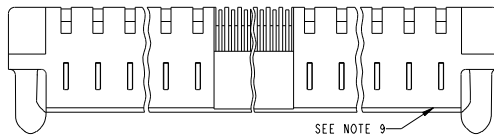

All rights strictly reserved. Reproduction or issue to third parties in any form or by any means without written authority from the proprietor. Property of FCJ. Copyright FCJ.

PRODUCT NUMBER
51760- ABBCCDDEF...
Note: ③
SEE NOTE 1



SEE NOTE 9

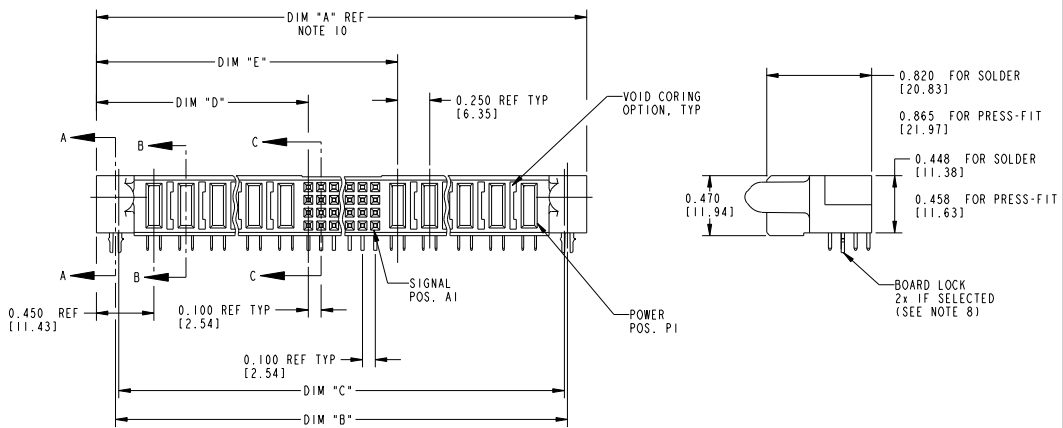

THIS FILE WAS ORIGINALLY CREATED IN THE PRO ENGINEER ENVIRONMENT AND ANY FUTURE REVISIONS TO THIS FILE MUST BE MADE IN THE PRO ENGINEER ENVIRONMENT

mat'l code				tolerances unless otherwise specified		CUSTOMER		FCJ	
SEE NOTE 2						COPY		www.fcjconnect.com	
lfr	ecn no.	dr	date	linear	.XX±.01/.X±.3	projection		title	
K	D605-0124	SJ	06/03/05		.XXX±.005/.XX±.13	⊕		RIGHT ANGLE RECEPTACLE w/GUIDE PIN	
L	D605-0485	GvoJM	11/21/05	angles	.XXX±.0020/.XX±.051	INCH / MM		POWER / SIGNAL / POWER	
M	D607-0498	JW	05/23/08		0°±.2°	scale		product family	
				dr	D. BOGLE 05-18-99	1:1		PwrBl code	
				eng	J. BROWN 05-18-99			code	
				chr	J. BROWN 05-18-99			213	
				appd	J. BROWN 05-18-99			SHEET	
sheet	revision	M	M	M				1 OF 3	
index	sheet	1	2	3					

form no. 7530-001-I03

1 | 2

3 |

cage code 22526

4

PDM: Rev:M

STATUS:Released

Printed: Dec 20, 2010

Tous droits strictement réservés. Reproduction ou communication à des tiers sans autorisation écrite du propriétaire. Property of FCJ. Droit de reproduction FCJ.



All rights strictly reserved. Reproduction or issue to third parties in any form or by any means without written authority from the proprietor. Property of FCJ. Copyright FCJ.

PRODUCT NUMBER	DIM	LENGTH FORMULAS (SEE NOTE 10)
51760-ABBCCDDDEF-- Note: ③		
SEE NOTE 1		

DIM "A"	.250 [6.35] x DD + .100 [2.54] x (CCC/4) + .250 [6.35] x BB + .650 [16.51] (NOTE 10)
DIM "B"	.250 [6.35] x DD + .100 [2.54] x (CCC/4) + .250 [6.35] x BB + .350 [8.89]
DIM "C"	.250 [6.35] x DD + .100 [2.54] x (CCC/4) + .250 [6.35] x BB + .300 [7.62]
DIM "D"	.250 [6.35] x DD + .375 [9.35]
DIM "E"	.250 [6.35] x DD + .100 [2.54] x (CCC/4) + .450 [11.43]
DIM "F"	.250 [6.35] x DD + .100 [2.54] x (CCC/4) + .250 [6.35] x BB + .680 [17.27]
DIM "G"	.250 [6.35] x DD + .225 [5.72]
DIM "H"	.250 [6.35] x DD + .100 [2.54] x (CCC/4) + .250 [6.35]

CONNECTOR NOTES

① PRODUCT NUMBER CODE:
51760 - A BB CCC DD E F LF

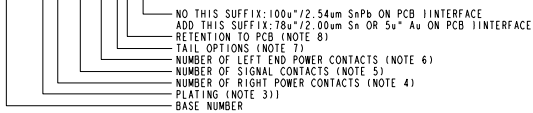

B = .150 [3.81] THRU HOLE (REQUIRES .158 ±0.003 [4.01 ±0.08] THRU HOLE IN PCB).
MOUNTING FOOT HEIGHT
160[4.06]

- ⑨. MANUFACTURE'S NAME, P/N, AND DATE CODE TO APPEAR ON THIS SURFACE.
- ⑩. THE MAXIMUM OVERALL LENGTH (DIM A) OF A PART IS 8.00 [203.2]
- ⑪. PRODUCT SPECIFICATION GS-12-149
- ⑫. APPLICATION SPECIFICATION BUS-20-067.
- ⑬. FOR PRESS-FIT CONNECTORS USE FCJ CAM TOOL 430140-XXX TO APPLY CONNECTOR TO PCB.

PCB NOTES:

- 14. ALL DIMENSIONS ARE BASIC UNLESS OTHERWISE SPECIFIED.
- 15. ALL THROUGH HOLES ARE LOCATED WITH A TRUE POSITION OF .004[0.10]
- 16. ALL HOLE DIAMETERS ARE FINISHED HOLE SIZE.
- ⑬. Ø 0.0453 ± .001 [1.151 ± 0.02] DRILLED HOLES PLATED WITH 0.0003 [0.007] MIN SnPb OVER 0.001 [1.03] TO .003 [0.08] PLATING TO ACHIEVE A .040 ± .003 [1.02 ± 0.08] HOLE.
- 18. THE VOID CORING IN BETWEEN POWER MODULES, SIGNAL MODULES AND END MODULES ARE OPTIONAL AND THE SHAPE MAY BE DIFFERENT FOR OPTIMIZING THE MOLDING PROCESS. THE VOID CORING WILL NOT EFFECT TO PRODUCT FUNCTION.
- 19. A Δ SYMBOL WILL BE NEXT TO ANY DIMENSION, VIEW, OR NOTE WHICH HAS BEEN MODIFIED WITH THE CURRENT DRAWING REVISION.

- ②. HOUSING MATERIAL: GLASS FILLED V-O HIGH TEMP THERMO PLASTIC.
SIGNAL CONTACT MATERIAL: COPPER ALLOY
POWER CONTACT MATERIAL: COPPER ALLOY
- ③. PLATING OPTION:
Δ 1: SEE IN PRINT 10064183 FOR PLATING SPEC OF 51760-ABBCCDDDEF; 51760-ABBCCDDDEF L
- ④. RIGHT END POWER CONTACTS, 01 TO 20 AVAILABLE.
MAXIMUM OF 20 POWER CONTACTS PER CONNECTOR
- ⑤. SIGNAL CONTACTS, 004 TO 148 AVAILABLE FOR SOLDER TO BOARD.
020 TO 148 AVAILABLE FOR PRESS-FIT TO BOARD.
- ⑥. LEFT END POWER CONTACTS, 01 TO 20 AVAILABLE.
MAXIMUM OF 20 POWER CONTACTS PER CONNECTOR
- ⑦. TAIL OPTIONS:
A = .135 ± .010 [3.43 ± .25] SOLDER TO BOARD
B = .090 ± .005 / .010 [2.29 ± 0.13 / -0.25] SOLDER TO BOARD
C = .154 ± .010 [3.91 ± 0.25] PRESS-FIT TO BOARD
- ⑧. RETENTION TO PCB OPTIONS:
A = BOARD LOCK (REQUIRES .098 ± .002 / -.001 [2.49 ± 0.05 / -0.03] THRU HOLE IN PCB)
MOUNTING FOOT HEIGHT:
220[5.59]
NOT AVAILABLE FOR PRESS-FIT

THIS FILE WAS ORIGINALLY CREATED IN THE PRO ENGINEER ENVIRONMENT AND ANY FUTURE REVISIONS TO THIS FILE MUST BE MADE IN THE PRO ENGINEER ENVIRONMENT

mat'l code				tolerances unless otherwise specified		CUSTOMER COPY		FCJ www.fcjconnect.com	
lfr	ecr no.	dr	date	linear	.XX±.01/.X±.3	projection	title		
M				angles	.XXX±.005/.XX±.13	1	RIGHT ANGLE RECEPTACLE w/GUIDE PIN POWER / SIGNAL / POWER		
				dr	0 ± .2	INCH / MM	product family	PwrBlade	code
				eng	D. BOGLE 05-18-99	1:2	size	51760	213
				chr	J. BROWN 05-18-99		scale		SHEET
				appd	J. BROWN 05-18-99				2 OF 3
sheet index	revision sheet								

form no. 7530-001-I03

1 | 2

3 |

code 22526

4

PDM: Rev:M

STATUS: Released

Printed: Dec 20, 2010

Tous droits strictement réservés. Reproduction ou communication à des tiers sans autorisation écrite du propriétaire. Property of FCJ. Droit de reproduction FCJ.



All rights strictly reserved. Reproduction or issue to third parties in any form or by any means without written authority from the proprietor. Property of FCJ. Copyright FCJ.

PRODUCT NUMBER
51760 - ABBCCDDEF _ _
Note: ③
SEE NOTE 1

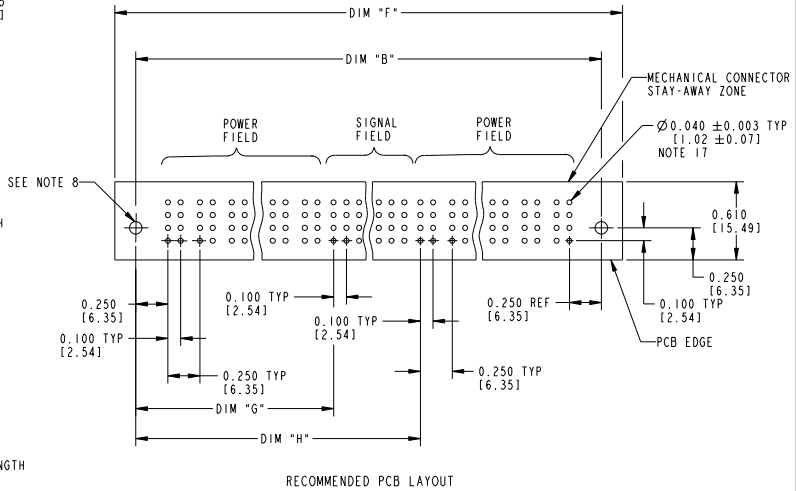
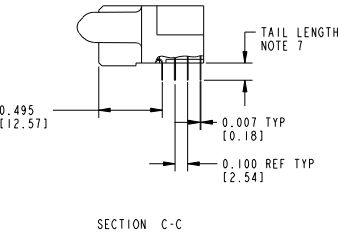
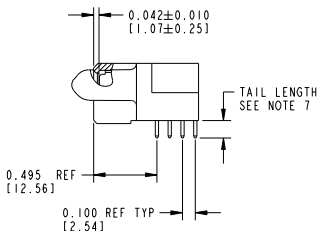
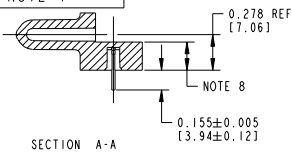

mat'l code				tolerances unless otherwise specified		CUSTOMER		FCJ		www.fcjconnect.com	
lfr	ecr no.	dr	date	linear	.XX±.01/.X±.3	projection		title		RIGHT ANGLE RECEPTACLE w/GUIDE PIN	
M				angles	.XXX±.005/.XX±.13	INCH / MM		POWER / SIGNAL / POWER		code	
				dr	.XXX±.0020/.XX±.051	scale		product family		PwrBlode	
				eng	0°±2°	1:1		size		213	
				chr	D. BOGLE 05-18-99			dwg no		SHEET	
				appd	J. BROWN 05-18-99			51760		3 OF 3	
					J. BROWN 05-18-99						
sheet index	revision sheet										

form no. 7530-001-103

cage code 22526

PDM: Rev:M

STATUS:Released

Printed: Dec 20, 2010