



SOLARLOK

Connectivity Systems for PV Installers

 **Tyco Electronics**
Our commitment. Your advantage.

Building a greener tomorrow

Tyco Electronics is committed to bringing the promise of renewable energy to the world. The SOLARLOK product offering provides a simple and reliable interconnection of solar systems. Tyco Electronics has worked with leaders in the solar industry to lower costs, increase reliability, and devise new and innovative ways to create and apply solar products.

Early involvement pays off in competition advantage

With approximately 7,000 engineers and 11 global design centers, plus manufacturing facilities in approximately 25 countries, we put a premium on innovation when it comes to helping companies solve tough design problems. Talking to us early on in your design cycle will give you the full benefit of our expertise.

We can help you:

Shorten the design cycle

Reduce costs

Increase reliability

Design for manufacturability

In short, we can help you achieve a sustainable competitive advantage. Whether it's showing you the best existing products, offering a value added solution or designing a new product, our commitment to advanced engineering and world-class manufacturing delivers innovation that can advance any lighting project. Our Electronic Components segment is a world leader in passive electronic components, including connectors and interconnect systems, relays, switches, circuit protection devices, touchscreens, sensors, and wire and cable. Tyco Electronics' ability to serve your present and future requirements is realized through the synergies of a strong R&D program and our expertise in materials science, product design and process engineering, all supported by our network of 5000-plus knowledgeable, sales representatives and customer service personnel.



TE Global Design Centers

- 1 : Harrisburg, PA : USA
- 2 : Greensboro/Winston-Salem, NC : USA
- 3 : Menlo Park, CA : USA
- 4 : Wilsonville, OR : USA
- 5 : Eatontown, NJ : USA
- 6 : Kawasaki, Japan
- 7 : Bensheim, Germany
- 8 : Shanghai, China
- 9 : Kessel-Lo, Belgium
- 10 : s'Hertogenbosch, Netherlands
- 11 : Kyungsan, Korea

Solar Manufacturing Facilities

- A : Trutnov, Czech Republic
- B : Greensboro, NC : USA
- C : Empalme, Mexico
- D : Hermosilla, Mexico
- E : DongGuann, China
- F : Shanghai, China
- G : QingDao, China

Mechanical, Environmental and Electrical Testing Capabilities

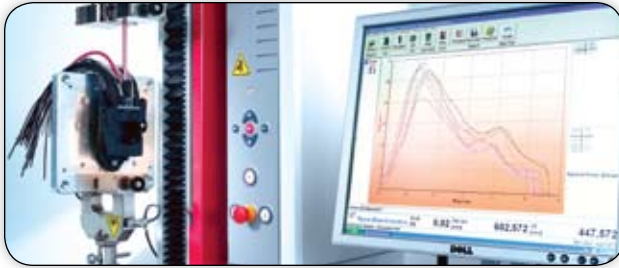

Mechanical Testing Equipment

Force-deflection curves are generated to verify that spring contact properties meet design criteria.



Electrical and Thermal Test Equipment

Contact resistance and temperature rise are measured and recorded automatically. These parameters help to establish/verify current carrying capacity, and de-rating curves. Test samples are isolated to minimize the influence of external variables such as air movement.



Climate cabinets and temperature shock chambers

Components/assemblies are exposed to cold, heat, moisture, and temperature change. Thermal shock is accomplished with the 2-chamber method. Environmental chambers operate from -70°C to $+180^{\circ}\text{C}$ enabling simulation of real-world conditions.



4-component pollutant gas unit/crimp validation

Slow-motion bending and vibration testing simulates line movements in the wire, stressing the crimped termination. Industrial atmospheres are generated with a gas mixture of SO_2 , H_2S , NO_2 and Cl_2 .



3D X-ray computer tomography

3D X-ray computer tomography provides high resolution three-dimensional non-destructive analysis capability.

Manufacturing Capabilities

**Tyco Electronics
manufactures the
SOLARLOK product
line on state of the
art manufacturing
equipment.**

The Trutnov, Czech Republic facility offers a repeatable manufacturing process which produces a 100% automatically inspected and electrically tested junction box. For quality control purposes, each junction box is “laser etched” with a unique serial number.

Our electrical test equipment has four independent heads to automatically test each connection rail and diode in the popular four rail junction box. Assembly equipment automatically verifies the production of the cable assemblies and attachment to the junction box. The true position of the contact in the mating coupler housing and proper torque of the screw nut are some of the critical process checks made to each unit. A vision system is incorporated into the junction box assembly equipment. Polarization and molded features are inspected by the same vision system to contribute to the production of a quality product and a repeatable manufacturing process.

The SOLARLOK product is currently manufactured in Europe, Asia and the USA.



Tyco Electronics Manufacturing Facility in Trutnov, Czech Republic

The SOLARLOK Product Concept

System Features

Junction Box

- Variable wiring options
- Simple, fast and cost-effective assembly
- Flat, low profile design
- High current carrying capacity
- Good thermal balance
- Connectorized or direct wire configurations
- Up to four outputs possible
- Up to six internal rails
- Customer-specific solutions
- TÜV and UL approved

Cable Couplers

- Simple on-site processing
- Mating safety provided by keyed housings
- Semi-automatic assembly capability possible
- Multiple plugging and unplugging cycles
- Accommodates solar cable with different insulation diameters
- High current carrying capacity
- Wide temperature operating range
- TÜV and UL approved

Solar Cable

- Dual wall insulation
- Electron beam cross-linked
- Excellent resistance to U.V., water, ozone, fluids, salt, general weathering
- Excellent resistance to abrasion
- Halogen free, flame retardant, low toxicity
- Very low smoke emissions
- Excellent flexibility and stripping performance
- Temperature Rating : -40°C up to +125°C
- Nominal Voltage : Vo/V 1800/3000 VAC, 600 VDC
- Test Voltage : 6KV, 50Hz, 5min
- Bending Radius : $\geq 5 \times$ outer diameter
- TÜV and UL approved



Simple and Reliable Interconnection of Solar Systems

Market expansion of the formerly regulated energy supply sector, increased global environmental awareness and governments committing themselves to more stringent environmental targets have opened up new opportunities for the photovoltaic industry.

Having served a niche market in the past, the photovoltaics industry now has the opportunity to move into mass production, realizing economies of scale and gaining a greater market share of the world's energy mix.

Tyco Electronics has contributed to the establishment of this environmentally-friendly technology with the introduction of its SOLARLOK connector system.

The SOLARLOK connector system delivers a flexible system solution for easy and reliable interconnections from photovoltaic modules to the DC/AC converter. The entire system concept is based on cost-effective and reliable processing of individual interconnection system components. This significantly reduces installation costs of the solar energy system.

The junction box concept is based on a flexible, open system structure, which allows serial as well as parallel interconnection via direct wire connect or separable connectors. Within the junction box, up to six termination places rails are available for photovoltaic foil connection. If required by the customer, the junction box can be delivered pre-configured with diodes, jumpers, plug connectors, and solar cable pigtails.

The male and female cable couplers were designed for high voltage and high current-carrying capacity in addition to the well-established IP 67 sealing requirement in the photovoltaic industry. Mating safety is provided by polarity keyed housings, fully shrouded contacts, reliable high cycle life, and a squeeze to release connection system. In addition, a wide temperature range and fulfillment of worldwide standards for photovoltaic connection systems complement the robust product specification.

Table of Contents

Combiner Box	Combiner Box.....	page : 8
Labels	Labels	page : 9
Connectors	Cable Coupler : Standard Line	page : 10
	Cable Coupler : Slim Line	page : 11
	Contacts	page : 12
	T-Branch Connector	page : 13
	AC Inverter Connector	page : 14
	Field Wiring, Switching and Protection.....	page : 15
Solar Cables	Solar Cables	page : 16-17
	Wiring Example with Extension Cables	page : 18
Grounding System	Grounding System : Grounding Bolt.....	page : 19
	Grounding System : Grounding Connectors.....	page : 20
Connectors	Interconnection Examples.....	page : 22-23
Tooling	Application Tooling	page : 24-25
Guidelines	Assembly and Installation Guidelines	page : 26-29
	Numerical Index.....	page : 30-31

- 1 Junction Box
- 2 Female Cable Coupler
- 3 Male Cable Coupler
- 4 Grounding Connector
- 5 Combiner Box
- 6 Caution Solar Circuit Label
- 7 DC Disconnect Label
- 8 Solar Disconnect Label
- 9 Solar Wire



1



2



4



6

CAUTION: SOLAR CIRCUIT



9



7



8

Combiner Box

Technical Data

Output Wire : Cu ONLY, 90°C, 14-4 AWG
 Maximum Voltage : 600 V
 Maximum Output Current : 75 A
 Maximum Continuous Current : 60 A
 Maximum Current Per String : 15 A
 Maximum Fuse Rating : 15 A
 Maximum Module Isc Per String : 9.6 A
 Enclosure Type : NEMA 3
 Ambient Temperature
 : -35°C to 50°C [-31°F to 122°F]
 Negative Output Terminal Torque
 : 4 Nm [35 in-lbs]
 Positive Output Terminal Torque
 : 14-10 AWG = 4 Nm [35 in-lbs]
 : 8 AWG = 4.5 Nm [40 in-lbs]
 : 6.4 AWG = 5.1 Nm [45 in-lbs]
 Ground Terminal Block Torque
 : 4Nm [35 in-lbs]

Features & Benefits

- Combines up to 5 PV strings
- Converts to standard wires
- Completely pre-assembled
- Plug & play design provides labor savings and minimizes installer error during installation
- Uses existing products currently produced by Tyco Electronics
- UL 1741 pending



SOLARLOK combiner box assembly is used to combine up to five strings in a preterminated connectorized weather-resistant enclosure to meet National Electric Code (NEC) requirements for series fusing of photovoltaic (PV) modules (solar panels).

The combiner box assembly consists of a box, cover (with hinges), transparent dead front lid (under the cover), and 10 pre-terminated SOLARLOK connectors each with a removable dust cover. The box features 4 knockouts (for output wiring), lock tab, mounting slots and pre-wired grounding clip.

The interior of the box holds 5 holder fuse blocks pre-wired to the positive SOLARLOK connectors, 5 terminal blocks pre-wired to the negative SOLARLOK connectors, and an equipment terminal block used to ground the equipment. Fuses are not included.

Part Number : 1954283-1

Labels



Solar Identification Labels

Quantity/Roll	TE Ordering Description	SAP Part Number	Label Description
5 rolls of 100	SOL-SD-104076-4-0.1	CN4616-000	Solar Disconnect
	SOL-DCD-104100-4-0.1	CN4619-000	DC Disconnect
	SOL-DPS-104019-4-0.1	CN4618-000	Warning - Dual Power Sources
	SOL-ESH-104019-4-0.1	CN4617-000	Warning - Electric Shock Hazard
500	SOL-SD-104076-4-0.5	CL3803-000	Solar Disconnect
	SOL-DCD-104100-4-0.5	CL3806-000	DC Disconnect
	SOL-DPS-104019-4-0.5	CL3804-000	Warning - Dual Power Sources
	SOL-ESH-104019-4-0.5	CL3805-000	Warning - Electric Shock Hazard



Solar Rating Labels

Quantity/Roll	TE Ordering Description	SAP Part Number	Label Description
5 rolls of 100	SOL-SRS-127508N-1-4	CR0780-000	System Inverter Rating
	SOL-CP-127508N-1-X	CR0781-000	Laminate for above label
	SOL-SRS-127698N-1-4	CR0782-000	System Charge Controller rating
	SOL-CP-127698N-1-X	CR0783-000	Laminate for above label
	SOL-SRS-812120N-1-4	CR0784-000	Generic System Rating
	SOL-CP-812120N-1-X	CR0785-000	Laminate for above label
500	SOL-SRS-127508N-5-4	CR0786-000	System Inverter Rating
	SOL-CP-127508N-5-X	CR0787-000	Laminate for above label
	SOL-SRS-127698N-5-4	CR0788-000	System Charge Controller Rating
	SOL-CP-127698N-5-X	CR0789-000	Laminate for above label
	SOL-SRS-812120N-5-4	CR0791-000	Generic System Rating
	SOL-CP-812120N-5-X	CR0792-000	Laminate for above label

Printer : T312M and/or T212M
(while they last)

Ribbon : 1330-0619-10

Software : WinTotal, Version 5.0

Note : Pre-print services are also available for "peel and stick" application with all pertinent electrical information. Inquire with Tyco Electronics for further information regarding this service. (For Americas only)



Solar Reflective Labels

Quantity/Roll	TE Ordering Description	SAP Part Number	Label Description
500	SOL-SEC-305254-4-0.1	CN6557-000	CAUTION : SOLAR ELECTRICAL SYSTEM
	SOL-CSC-159254-4-0.1	CN4615-000	CAUTION : SOLAR CIRCUIT

Cable Coupler : Standard Line



Technical Data

Electrical Features

Current Rating

: Up to 25 A for 2.5 mm²
 : Up to 30 A for 4.0 mm²
 : Up to 35 A for 6.0 mm²

Withstanding Voltage : 1000 V DC

Contact Resistance : 1 mΩ typical

Mechanical Features

Dimensions : Diameter 18 mm (.71 inch)

Protection Degree : IP 67, mated

Contact Finish : Silver plated

Standards

UL approved

TÜV approved



Technical Data

Electrical Features

Current Rating : Up to 25 A

Withstanding Voltage : 1000 V DC

Contact Resistance : ≤ 5 mΩ, mΩ typical

Mechanical Features

Dimensions : Diameter 18 mm (.71 inch)

Protection Degree : IP 67, mated

Contact Finish : Silver plated

Standards

UL approved

TÜV approved

Female Cable Coupler (kit with screw-machined contact)

Gen 3 Seal Part Number	Gen 2 Seal Part Number	Wire Size		Keying	Package Quantity
		Cable Outer Diameter 5.5 mm to 8.0 mm	Cable Outer Diameter 4.5 mm to 6.0 mm		
1394462-1	4-1394462-6			Plus	100
1394462-3	4-1394462-8			Plus	100
5-1394462-5	6-1394462-3			Plus	100
1394462-2	4-1394462-7			Minus	100
1394462-4	4-1394462-9			Minus	100
5-1394462-6	6-1394462-4			Minus	100

Female Cable Coupler (without contact : only housing and sealing)

Gen 3 Seal Part Number	Gen 2 Seal Part Number	Wire Size		Keying	Package Quantity
		Cable Outer Diameter 5.5 mm to 8.0 mm	Cable Outer Diameter 4.5 mm to 6.0 mm		
1740940-3	1-1740940-3			Plus	2,500
1740940-4	1-1740940-4			Minus	2,500



Male Cable Coupler (kit with screw-machined contact)

Gen 3 Seal Part Number	Gen 2 Seal Part Number	Wire Size		Keying	Package Quantity
		Cable Outer Diameter 5.5 mm to 8.0 mm	Cable Outer Diameter 4.5 mm to 6.0 mm		
1394461-1	1394461-7			Plus	100
1394461-3	7-1394461-0			Plus	100
6-1394461-5	7-1394461-3			Plus	100
1394461-2	1394461-8			Minus	100
1394461-4	7-1394461-1			Minus	100
6-1394461-6	7-1394461-4			Minus	100
6-1394461-1	6-1394461-3			Neutral	100
6-1394461-2	7-1394461-2			Neutral	100
6-1394461-4	7-1394461-5			Neutral	100

Male Cable Coupler (without contact : only housing and sealing)

Gen 3 Seal Part Number	Gen 2 Seal Part Number	Wire Size		Keying	Package Quantity
		Cable Outer Diameter 5.5 mm to 8.0 mm	Cable Outer Diameter 4.5 mm to 6.0 mm		
1740939-5	--			Plus	2,500
1740939-4	--			Minus	2,500
1740939-2	1-1740939-2			Neutral	2,500



Cable Coupler : Slim Line



Female Cable Coupler (kit with screw-machined contact)

Part Number	Wire Size		Keying	Package Quantity
	mm2	AWG		
1987559-1	2.5	14	Plus	100
1-1987559-1	4.0	12	Plus	100
1987559-2	2.5	14	Minus	100
1-1987559-2	4.0	12	Minus	100

Technical Data

Electrical Features

Current Rating

: Up to 25 A for 2.5 mm²
: Up to 30 A for 4.0 mm²

Withstanding Voltage : 1000 V DC

Contact Resistance : 1 mΩ typical

Mechanical Features

Dimensions : Diameter 18 mm (.71 inch)

Protection Degree : IP 67, mated

Contact Finish : Silver plated

Standards

TÜV approved

Female Cable Coupler (without contact : only housing and sealing)

Part Number	Wire Size		Keying	Package Quantity
	mm2	AWG		
1987287-1	--	--	Plus	2,500
1987287-2	--	--	Minus	2,500



Male Cable Coupler (kit with screw-machined contact)

Part Number	Wire Size		Keying	Package Quantity
	mm2	AWG		
1987558-1	2.5	14	Plus	100
1-1987558-1	4.0	12	Plus	100
1987558-2	2.5	14	Minus	100
1-1987558-2	4.0	12	Minus	100
1987558-3	2.5	14	Neutral	100
1-1987558-3	4.0	12	Neutral	100

Technical Data

Electrical Features

Current Rating : Up to 25 A

Withstanding Voltage : 1000 V DC

Contact Resistance : ≤ 5 mΩ, mΩ typical

Mechanical Features

Dimensions : Diameter 18 mm (.71 inch)

Protection Degree : IP 67, mated

Contact Finish : Silver plated

Standards

TÜV approved

Male Cable Coupler (without contact : only housing and sealing)

Part Number	Wire Size		Keying	Package Quantity
	mm2	AWG		
1987286-4	--	--	Plus	2,500
1987286-5	--	--	Minus	2,500
1987286-6	--	--	Neutral	2,500



Contacts

Technical Data

Materials

Contact : Silver plated, copper alloy

Electrical Features

Current Rating

: Up to 25 A for 2.5 mm²

: Up to 30 A for 4.0 mm²

: Up to 35 A for 6.0 mm²

Female Contacts (Screw-Mounted)

Material : Copper alloy, silver plated

Part Number	Wire Size (mm ²)	Wire Size (AWG)	Package Quantity
1987281-1	2.5	--	100
1987281-2	4.0	--	100
1987281-3	6.0	AWG 10	100
1987281-4	--	AWG 14	100
1987281-5	--	AWG 12	100

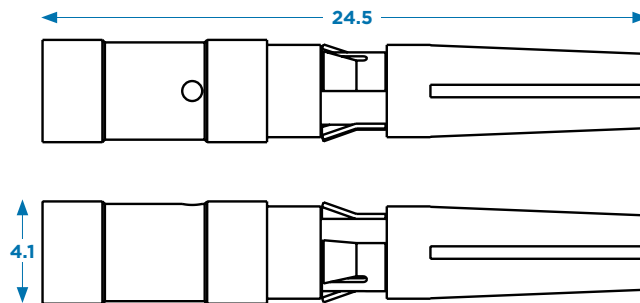

Male Contacts (Screw-Mounted)

Material : Copper alloy, silver plated

Part Number	Wire Size (mm ²)	Wire Size (AWG)	Package Quantity
1987280-1	2.5	--	100
1987280-2	4.0	--	100
1987280-4	6.0	AWG 10	100
1987280-3	--	AWG 14	100
1987280-5	--	AWG 12	100

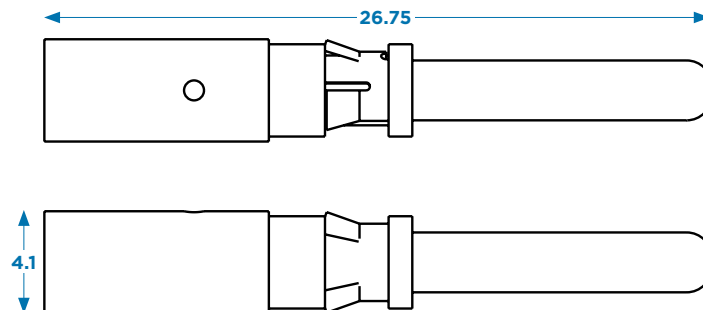

T-Branch Connector

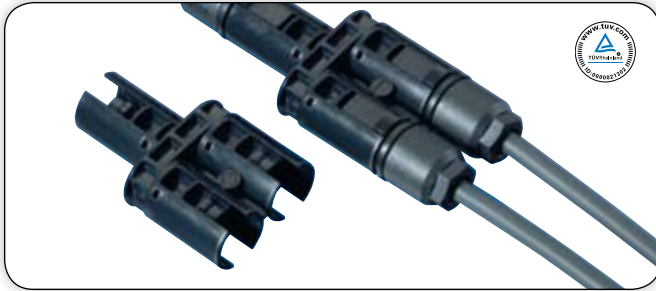

Parallel Interconnection using T-Branch Connector (Male-to-Male)

Part Number	Keying	Package Quantity
1534611-1	Plus	20
1534611-2	Minus	20



Parallel Interconnection using T-Branch Connector (Female-to-Male)

Part Number	Keying	Package Quantity
1740277-1	Plus	20
1740277-2	Minus	20

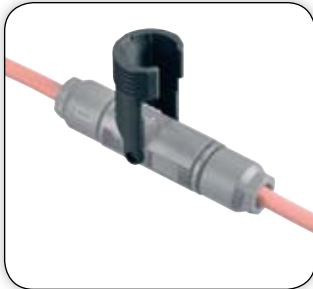

Safety + Clip (Optional Connector Latch Locking Clip Standard)

Part Number	Description	Package Quantity
1534226-1	Standard	100
2106207-1*	NEC 2008	100

*Instruction Sheet : 408-10296

Female Housing : with strap



Female Housing : no strap



Connector Dust Covers

Part Number	Description	Package Quantity
1987423-1	Female housing cover with strap	100
1394739-1	Male housing cover with strap	100
1987424-1	Female housing no strap	100
1987419-1	Male housing no strap	100

Male Housing : with strap



Male Housing : no strap



AC Inverter Connector

Technical Data

Electrical Features

Current Rating : 25 A per Pole

Voltage Rating : 400 V

Mechanical Features

Protection Degree : IP67 (mated)

No. of Positions : 5 Poles

Temperature Range : -40°C up to +50°C

Wire Size Range : 2.5 mm² - 6.0 mm²

Standards

Approvals VDE Certified



Panel Mount Plug

Part Number	Nut	Cable Length (5 x 4.0 mm ²)	Package Quantity
1740483-1	Metal	200 mm	24
1740483-2	Plastic	200 mm	24



Free Hanging Receptacle

Part Number	Nut	Cable Length (5 x 4.0 mm ²)	Package Quantity
1740479-1	-	-	24



Complete Sets

Part Number	Nut	Cable Length (5 x 4.0 mm ²)	Package Quantity
1740493-1	Metal	200 mm	24
1740493-2	Plastic	200 mm	24

Field Wiring, Switching and Protection

Switching

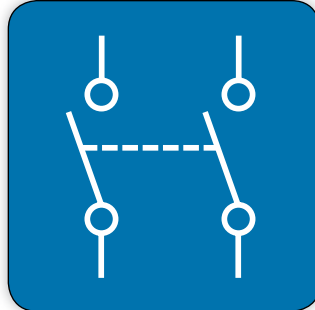

- One-/two-pole switches
- Main switch function
- Lockable
- Current up to 60 A DC
- Voltage up to 1,000 V DC

Collecting

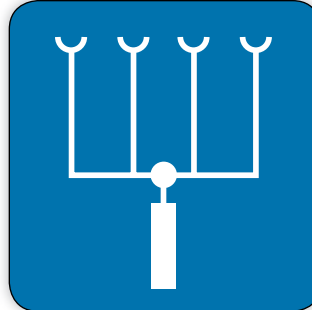

- 2 to 6 strings input
- Cable cross section up to 6 mm²
- SOLARLOK connectors
- Current up to 60 A DC
- Voltage up to 1,000 V DC

Collecting

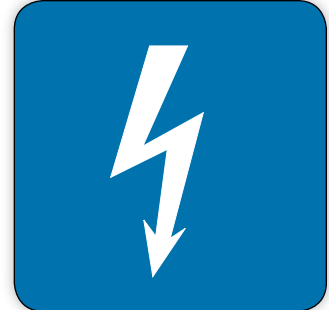

- Lighting protection

**Your
Solution**



The photovoltaic integrator looks for best fit solutions to wire various types and sizes of solar generators.

The new product concept from Tyco Electronics provides this flexibility to photovoltaic integrators.

This modular product can be comprised of a switch, lighting protection, fuses or any combination of these or other commonly available components.

We can customize a product to fit your specific application. Please contact us with your requirements.

Solar Cable : Global TÜV and UL 4703

Technical Data

Material

Conductor : Stranded tin plated copper

Insulation : Electron beam cross-linked polyolefin

Sheath : Electron beam cross-linked halogen free polyolefin

Color : Black, Blue, Red

Electrical Features

Voltage Rating

(as per TÜV requirement
600/1000 VAC, 1800 V DC)

: 1800/3000 VAC

: 2600 VDC

Wire Size Range

: 2.5 mm² (AWG 14)

: 4.0 mm² (AWG 12)

: 6.0 mm² (AWG 10)

Standards

TÜV certified according to ZPFG
1169/08.2007 (PV1-F) : RG0021060

UL certified according to UL Outline 4703
(PV wire, type ZKLA) : E317230

Fire Performance : IEC 60332-1-2, UL 1581
1080/VW1, EN 50267-2-1/2, EN 50305

Conductor : IEC 60228 class 5 (stranded
and flexible tin plated copper wire)

Features & Benefits

- TÜV and UL approved
- Dual wall insulation
- Electron beam cross-linked
- Excellent resistance to abrasion
- Halogen free, flame retardant, low toxicity
- Excellent flexibility and stripping performance
- Wire size from 2.5 mm² up to 6.0 mm²



As part of expanding the SOLARLOK product line, Tyco Electronics produces wire that is designed to meet the harsh environmental conditions typical of photovoltaic installations. The flexible, dual wall, halogen free and cross linked solar wire offers long term stability with TÜV UL approval. Its outstanding features include: high resistance against environmental conditions such as humidity, UV-radiation and ozone. In addition, it has excellent resistance to abrasion and temperature extremes. The wire has a high dielectric withstanding voltage and due to its fine-stranded, tin plated copper conductor, it is easy to handle, bend, route, and to strip.

Global TÜV and UL 4703

Color	Part Number	Cross Section		Conductor		Diameter (mm)	Weight (kg/km)	Reel Package (m)
		mm ²	AWG	Construction no. x mm	Max Diameter (mm)			
Black	956297-4	2.5	14	50 x 0,26	1.95	6,65 +0,15/-0,1	62.5	500
	956298-4	4.0	12	56 x 0,31	2.50	6,90 +/-0,10	75.8	500
	956299-4	6.0	10	84 x 0,31	3.05	7,35 +0,3/-0,25	95.5	500
	1-956297-4	2.5	14	50 x 0,26	1.95	6,65 +0,15/-0,1	62.5	100
	1-956298-4	4.0	12	56 x 0,31	2.50	6,90 +/-0,10	75.8	100
	1-956299-4	6.0	10	84 x 0,31	3.05	7,35 +0,3/-0,25	95.5	100
Red	956297-5	2.5	14	50 x 0,26	1.95	6,65 +0,15/-0,1	62.5	500
	956298-5	4.0	12	56 x 0,31	2.50	6,90 +/-0,10	75.8	500
	956299-5	6.0	10	84 x 0,31	3.05	7,35 +0,3/-0,25	95.5	500
	1-956297-5	2.5	14	50 x 0,26	1.95	6,65 +0,15/-0,1	62.5	100
	1-956298-5	4.0	12	56 x 0,31	2.50	6,90 +/-0,10	75.8	100
	1-956299-5	6.0	10	84 x 0,31	3.05	7,35 +0,3/-0,25	95.5	100
Blue	956297-6	2.5	14	50 x 0,26	1.95	6,65 +0,15/-0,1	62.5	500
	956298-6	4.0	12	56 x 0,31	2.50	6,90 +/-0,10	75.8	500
	956299-6	6.0	10	84 x 0,31	3.05	7,35 +0,3/-0,25	95.5	500
	1-956297-6	2.5	14	50 x 0,26	1.95	6,65 +0,15/-0,1	62.5	100
	1-956298-6	4.0	12	56 x 0,31	2.50	6,90 +/-0,10	75.8	100
	1-956299-6	6.0	10	84 x 0,31	3.05	7,35 +0,3/-0,25	95.5	100



Solar Cable : Type USE-2

Technical Data

Electrical Features

Voltage Rating : 600 V DC

Mechanical Features

Operating Temperature : up to +90°C

Standards

UL certified to 854 (USE-2) : 10-14 AWG
UL File E314122 and E314123



Features & Benefits

- Insulation provides resistance to U.V., water, ozone, fluids, salt, gasoline, and petroleum general weathering
- High strand count conductor provides flexibility and stripping performance
- Multiple cable diameters available

USE-2 approved solar cable - for the North American market UL approved cable is offered in 10 through 14 AWG. This cable is approved for USE-2, XHHW-2, RHW-2, or RHH. Sunlight, gasoline, and petroleum resistance make this an ideal cable for any solar installation in North America. A high strand count increases the flexibility and tinned copper wire strands ease the use of this cable.

Type USE-2 (For US Installation), UL Approved Cable

Color	Part Number	Cross Section AWG	Diameter (inch)	Reel Package (ft)
Black	1986166-1	14	0.17	7,500
	1986166-2	14	0.17	500
	1986166-3	14	0.17	2,500
	1986165-1	12	0.19	7,500
	1986165-2	12	0.19	500
	1986165-3	12	0.19	2,500
	1986164-1	10	0.21	7,500
	1986164-2	10	0.21	500
	1986164-3	10	0.21	2,500

Wiring Example with Extension Cables

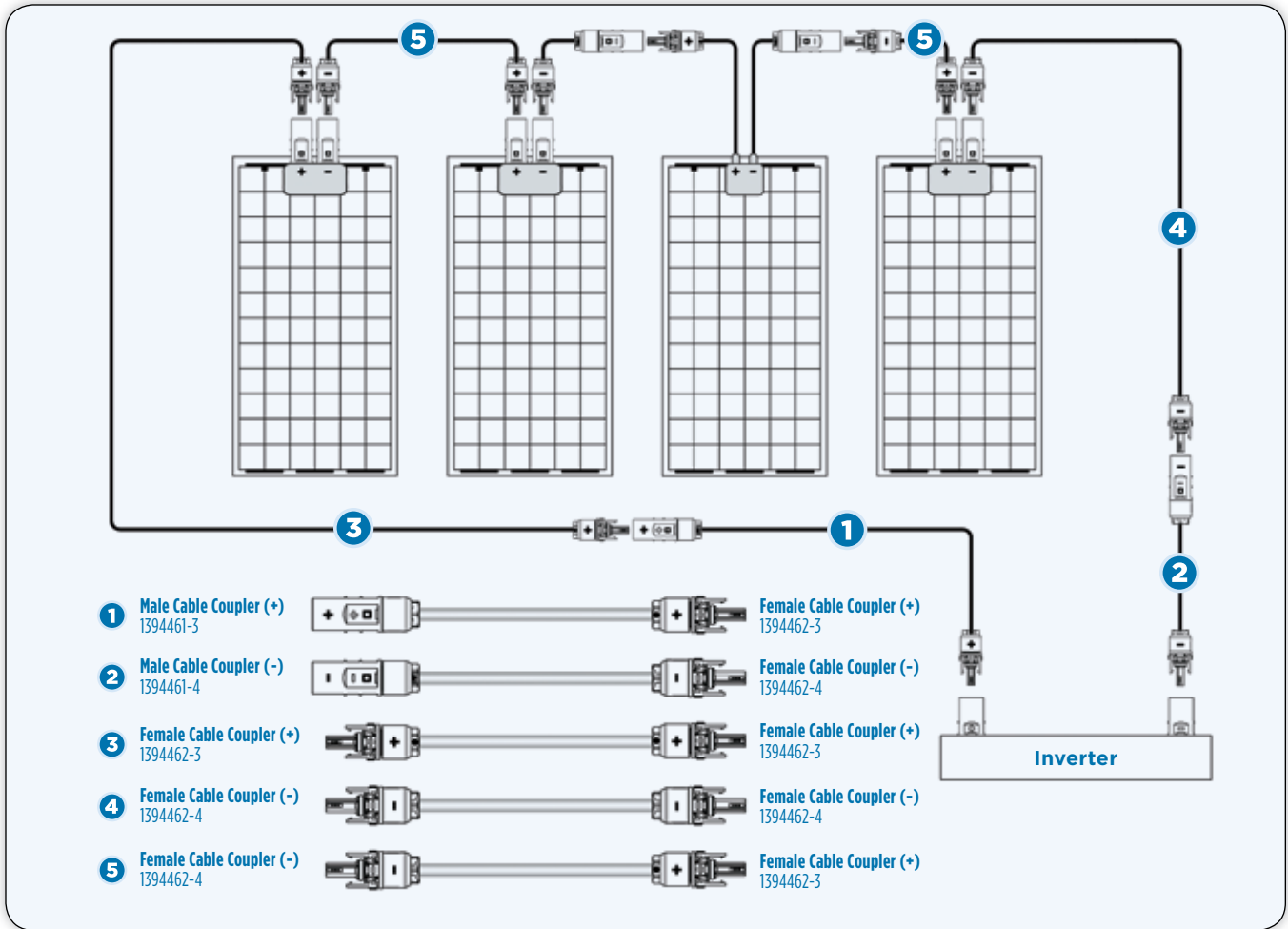

Configuration Example at 4.0 mm²

Cable Assembly

Cable Assembly Version	Part Numbers for Cable Length				
	1 m	3 m	5 m	10 m	20 m
1	1987376-1	1987376-2	1987376-3	1987376-4	1987376-5
2	1-1987376-1	1-1987376-2	1-1987376-3	1-1987376-4	1-1987376-5
3	2-1987376-1	2-1987376-2	2-1987376-3	2-1987376-4	2-1987376-5
4	3-1987376-1	3-1987376-2	3-1987376-3	3-1987376-4	3-1987376-5
5	4-1987376-1	4-1987376-2	4-1987376-3	4-1987376-4	4-1987376-5

More variants (cable length, wire diameter, color) upon request.



Grounding System : Grounding Bolt

Technical Data

Materials

Connector & Hardware

: Stainless Steel (Passivated)

Electrical Features

Short Term Current Test (UL 467)

: 6 AWG = 1530A (6 seconds)

: 8 AWG = 1180A (4 seconds)

: 10 AWG = 750A (4 seconds)

: 12 AWG = 470A (4 seconds)

Mechanical Features

Securness Test (ul 486A-B)

: 6 AWG = 18lbs (30 minutes)

: 8 AWG = 8lbs (30 minutes)

: 10 AWG = 5lbs (30 minutes)

: 12 AWG = 5lbs (30 minutes)

Pull out Test (ul 486A-B)

: 6 AWG = 100lbs (1 minute)

: 8 AWG = 90lbs (1 minute)

: 10 AWG = 80lbs (1 minute)

: 12 AWG = 70lbs (1 minute)



Product Offering

Part Number	Description	Thread	Dim "A"	Package Quantity
2058729-1	6-12 AWG	#8-32 UNC	.380	100
2106831-1	Long Shank 6-12 AWG	#10-32 UNF	.700	100

*Instruction Sheet : 408-10262

Dimensions

Application Tooling

Flex socket wrench or wrenches

Standards

UL 467 approved

UL File #E69905

A requirement for UL 1703
solar panel listing)

CSA C22.2 No. 41-07

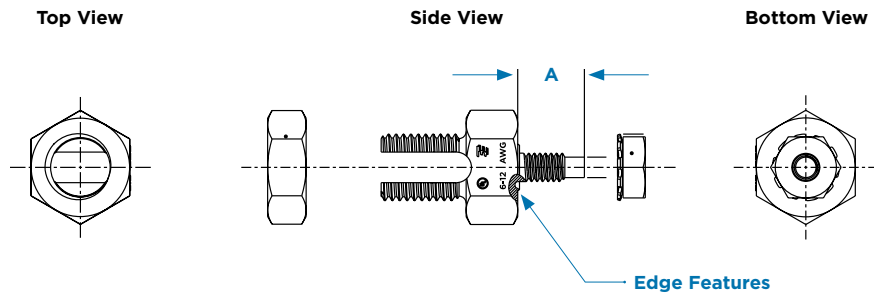

Features & Benefits

- Rugged and compact hex bolt design made from stainless steel.
- Quick and easy mounting procedures.
- Bottom edge feature cuts through the anodized aluminum surface when securing the hex bolt to the module frame.
- Standard tooling can be used with the hex nuts.

Grounding System : Grounding Connectors

Technical Data

Materials

Housing : Durable PBT 30% glass filled polyester. Material is outdoor & UV rated
Contact : High conductivity, copper

Electrical Features

Meets the tough requirements of photovoltaic grounding applications and the 2008 National Electrical Code.

Mechanical Features

Meets the tough requirements for grounding applications for solid copper wire.
 12 AWG applications will withstand 70lbs pull while the 10 AWG applications will withstand 80lbs pull

Application Tooling

No special tooling is required -- only flathead screwdrivers and channel lock pliers (optional)

Standards

UL 467 approved
 UL File #E69905
 A requirement for UL 1703 solar panel listing
 CSA C22.2 No. 41-07

Features & Benefits

- Product comes as an assembled kit that includes an attachment screw
- Contact design provides 4 points of contact to the ground wire for high reliability
- Product is easy to install with simple tools that are readily available
- Removal of the installed ground wire requires a screwdriver, this meeting the tooled extraction requirements
- RoHS compliant



Product Offering

Part Number	Screw	Nut	Package Quantity
1954381-2	#8-32 Pan Head	#8-32	100
1954381-1	#10-32 Thread Cutting	None	100

*Instruction Sheet : 408-10160

3 Easy Steps to Ground Your PV System

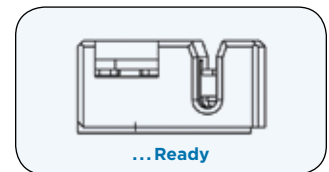
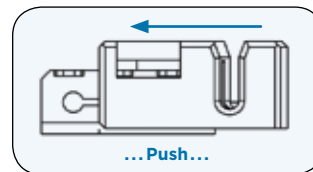
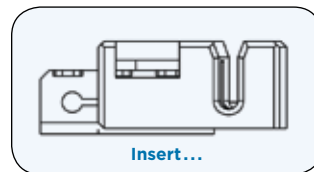

Dimensions

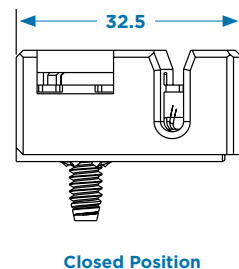
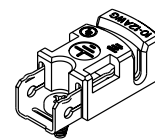
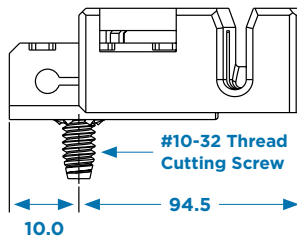
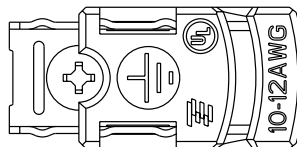
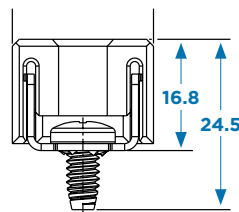
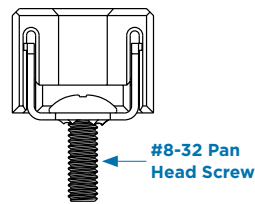

Interconnection Examples

Serial Interconnection for Junction Boxes with Cable Glands
(4.0 mm²/ 12 AWG Wiring)

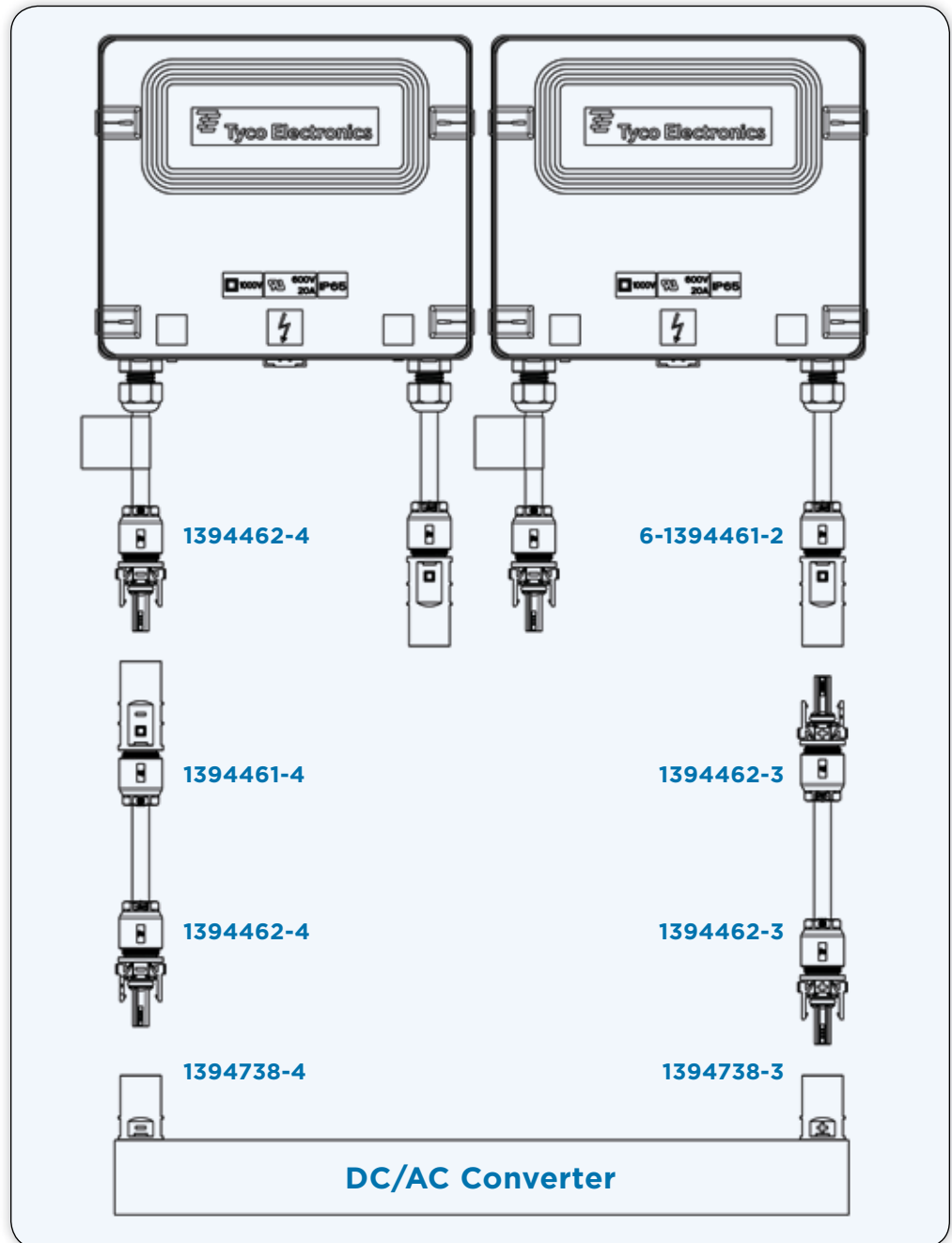

Interconnection Examples (continued)

Serial Interconnection for Junction Boxes with Plug Connectors
(4.0 mm²/ 12 AWG Wiring)

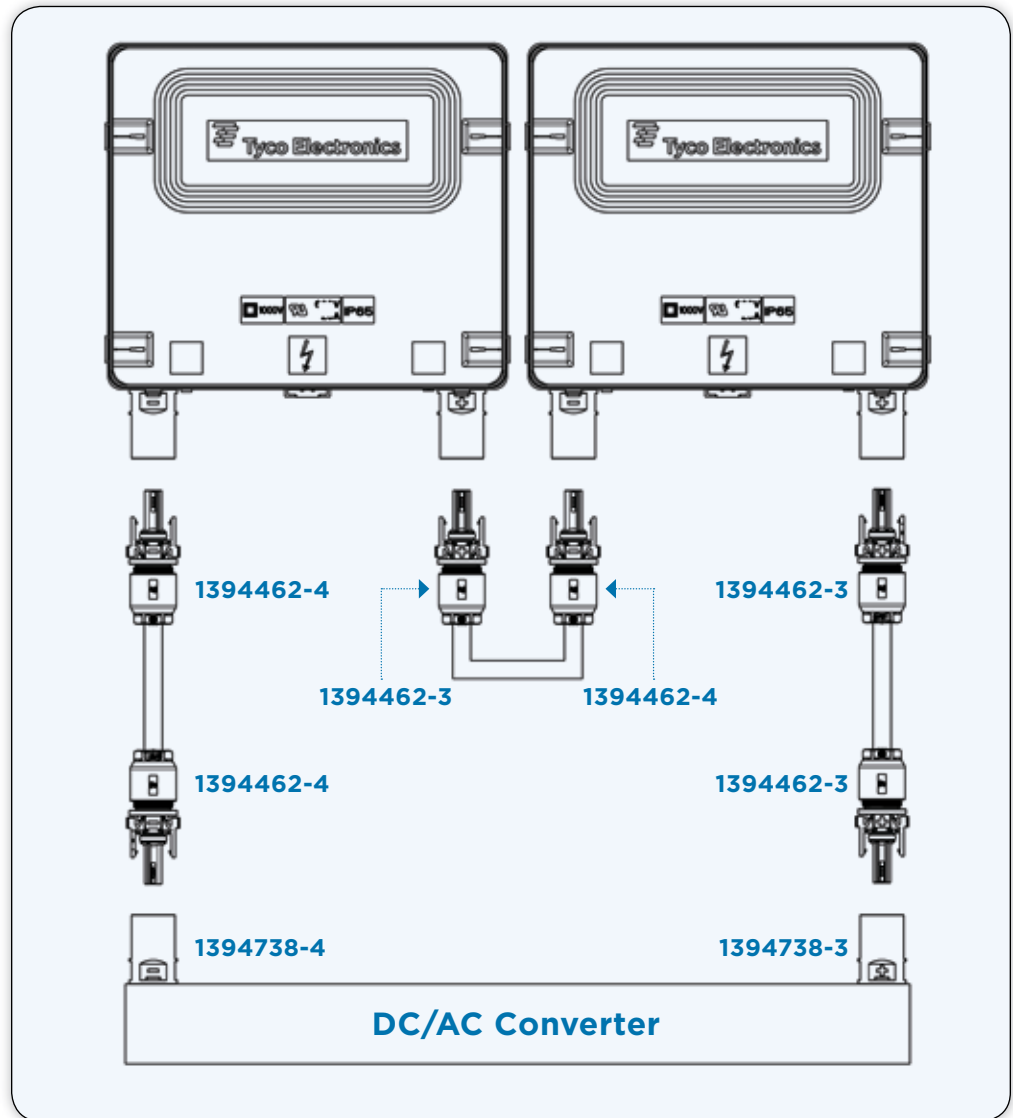

Application Tooling

Cable Assembly Tooling Specs

- 1 Hand Crimp Tool for Screw Machine Contacts**
Includes Crimp Head & Locator
PN : 1-1579004-1 (1.5 mm² & 2.5 mm²)
: 1-1579004-2 (4.0 mm² & 6.0 mm²)
- 2 Hand Crimp Tool for Stamped & Formed Contacts**
Includes SDE Die Set & Locator
PN : 2063900-1 (2.5 mm² - 6.0 mm²)
(AWG 10-14)
- 3 Extraction Tool**
(suitable for all wire sizes)
PN : 1102855-3
- 4 Insulator Stripper**
Includes length stop for all wire size
(Suitable for our Solar Cable)
PN : 4-1579002-2 (1.5 mm², 2.5 mm²,
4.0 mm² and 6.0 mm²)



Applicator for Strip Form Contacts (Not Shown)
PN : 1855503-1

Applicator for Strip Form Contacts

Part Number	Power Unit	Feed Type	Description
1855503-1	Leadmaker	Post Feed	Cuts Carrier
1855503-2	Bench Model K	Pre Feed	Cuts Carrier
1855503-3	Bench Model G	Pre Feed	Cuts Carrier
1855503-6	Leadmaker	Post Feed	Continuous Carrier

SOLARLOK Electric Terminator CS 200

Base Machine : PN : 539630-1

Electrical Terminator CS 200 for Screw Machine Contacts

Adaptor for Crimp Head
PN : 1579000-4

Crimp Head
(1.5 mm² and 2.5 mm²)
PN : 7-1579001-8

Crimp Head
(4.0 mm² and 6.0 mm²)
PN : 7-1579001-9

Crimp Head (AWG 10)
PN : 8-1579001-2

Crimp Head (AWG 12)
PN : 5-1579001-5

Electrical Terminator CS 200 for Stamped & Formed Contacts

Adaptor for SDE Crimp Die Sets
PN : 1673663-2

SDE Die
PN : 2063900-2



Application Tooling (continued)

Junction Box Assembly Tooling

- 1** Wire Spring Clamp Tool
PN : 1579007-2
- 2** Dioden/Jumper Spring Clamp Tool
PN : 1579007-5
- 3** Foil Spring Clamp Tools
 - 6 Rail Large Box (Shown)
PN : 1579007-3
 - 5 Rail (Not Shown)
PN : 1740969-3
 - 4 Rail Medium Box (Not Shown)
PN : 1740969-1
 - 3 Rail Small Box (Not Shown)
PN : 1740969-2

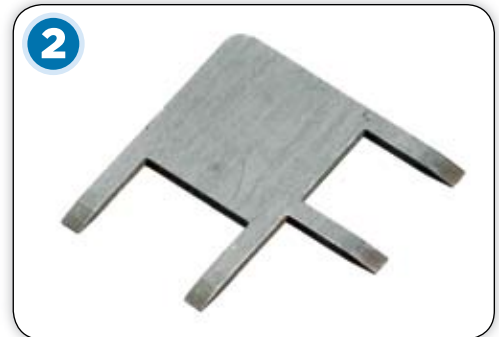

Junction Box & Connector Assembly Tooling

- 1** Hexagon Spanner Head Wrench,
size 13 mm
PN : 523229-1

Field Service Kit

Base Machine

Part Number : 1534858-1
(Metric Wire)

Hand Crimp Tool

PN : 1-1579004-2

Extraction Tool

PN : 1102855-3

Insulation Stripper

PN : 4-1579002-2

- 100 Cable Coupler
(Housings, Plus and Minus coded)
- Crimp Contacts
(4.0 mm² and 6.0 mm²)
- Strain relief
- Seals



Assembly and Installation Guidelines SOLARLOK plug connectors

ATTENTION : This connector is to be used only to interconnect firmly fixed cables

DO NOT DISCONNECT UNDER LOAD : Current path should only be disconnected using approved disconnect devices.

Cable assemblies are labeled with PN : 1394470-1.

PROTECT AGAINST SHOCK : Ensure that conductors and their associated connectors are separated from opposite polarity components.

IMPORTANT NOTE

Mounting and installation must be done by qualified and trained staff considering all applying safety regulations. Failure to follow all instructions in Application Specification 114-18488 (available at www.tycoelectronics.com/documents), including using only approved TE tooling (if applicable), can result in improper installation and/or crimping which is dangerous and may cause or contribute to electrical fires. Should be used only by individuals with proper training and experience.

General Comments

Any kind of pollution (dust, oil, humidity, etc.) during the assembly process or to the unmated connector can degrade contact and connector performance. This applies in particular to the seals and the crimping of the contacts. A clean assembly environment is essential.

Termination of the Cable Wires and Crimping of the Contacts

- SOLARLOK connectors use different crimp contacts for various wire gauges.
- Possible wire gauges are 2.5 mm², 4.0 mm², and 6.0 mm², AWG 14, AWG 12 and AWG 10.
- The tools to be used are selected based upon the wire gauge.
- For the application specification, please refer to specification #114-18488.

3.1 Handling of the Connectors

When assembling the connectors, the following sequence must be followed:

- 1 : Stripping the wire to 9 +/- 1mm without damaging the strands (please refer to application specification **#114-74013**)



Fig.1

Assembly and Installation Guidelines (continued)

3.1 Handling of the Connectors (continued)

2 : Insert the stripped wire into the wire crimp barrel until it stops.

3 : While holding the wire in place, squeeze tool handles together until ratchet releases.



Fig. 2

4 : Push contact with cable into the connector housing (include seal/pinch ring combination and backshell) until you hear the contact is locked into position. To verify contact engagement, give a gentle pull back on the cable to be sure the contact is locked.



Fig. 3

5 : Tighten backshell nut to 1.3 +0.2 Nm.



Fig. 4

Assembly and Installation Guidelines (continued)

3.2 Connector Latching **When mating the SOLARLOK connectors, ensure the following:**

1 : Connectors labeled with a plus or minus are keyed and can only be mated to similarly marked and keyed connectors.

CAUTION : THE “NEUTRAL” DESIGNATED PIN CONNECTORS INCORPORATE NO KEYING FEATURES AND MUST ONLY BE USED FOR SERIAL INTERCONNECTION OF PHOTOVOLTAIC MODULES. THE NEUTRAL PRODUCT SHOULD NOT BE USED WHERE MAINTAINING POLARITY IS CRITICAL.

2 : The polarity of the “neutral” connector should be labeled with **part number : 1394725-1 or 1394725-2.**

3 : The connector system is fully latched only when the latches are flush with the mating connectors. After the connector is fully latched, the optional latch locking clip may be snapped into place.



Fig. 5
(female connector)

3.3 Disconnecting **CAUTION : DO NOT DISCONNECTED UNDER LOAD.**

Disconnect circuit load before unplugging connectors by using approved devices (DC main switch, inverter connector and other devices). Cable assemblies should be labeled with **part number : 1394470-1.**

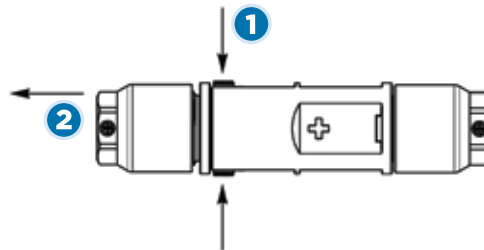

Fig. 6

1 : The locking mechanism is opened by depressing the latches.

2 : Pull out the connectors. While depressing the latches, disconnect the connector by pulling the connector halves apart.

Assembly and Installation Guidelines (continued)

Application Examples



Abb. 7 : Serial (Wire Diagram)



Abb. 8 : Parallel (Wire Diagram)

Storage See product specification 108-18701

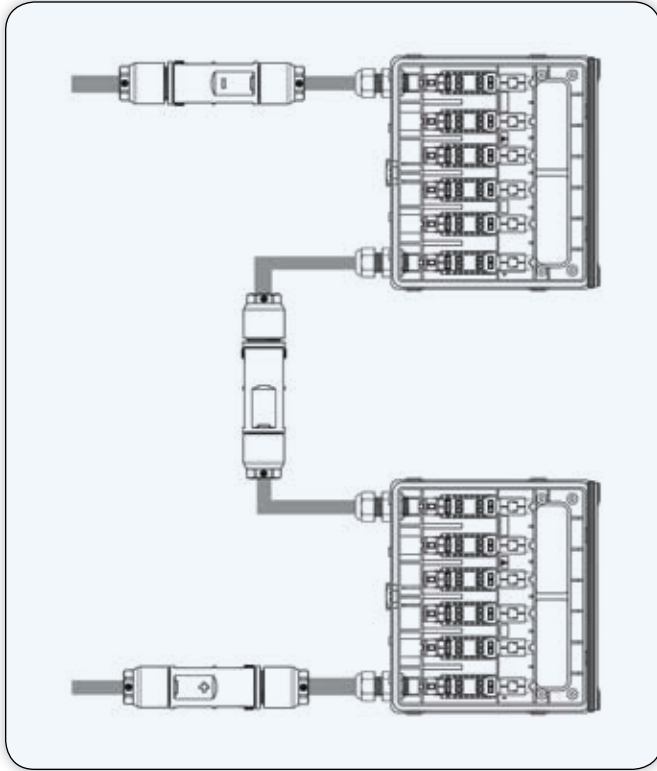
Tooling Find available tools for the contact crimping on page 24 (please specify the required wire gauge). An extraction tool (part number 1102855-3) is needed to disassemble the connector components. The tool is used to unlock the contact retention features, after which the contact can be removed and re-used one time if necessary.

Technical Description

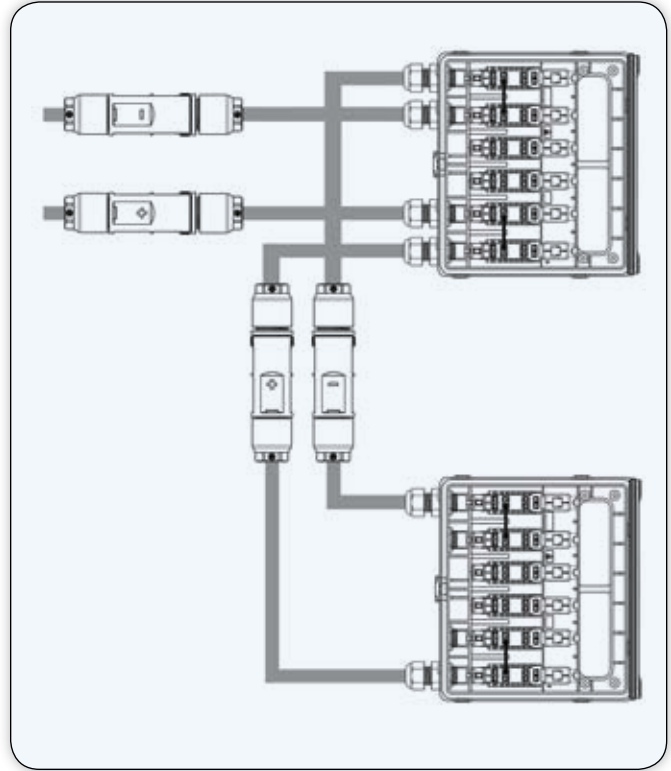
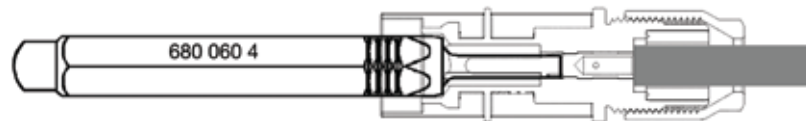



Fig. 9

PV Installers Numerical Index

Part Number	Page	Part Number	Page	Part Number	Page
CN4616-000	9	956298-6	16	1394462-3	10
CN4619-000	9	1-956298-4	16	1394462-4	10
CN4618-000	9	1-956298-5	16	4-1394462-7	10
CN4617-000	9	1-956298-6	16	4-1394462-8	10
CN3803-000	9	956299-4	16	4-1394462-9	10
CN3806-000	9	956299-5	16	5-1394462-6	10
CN3804-000	9	956299-6	16	5-1394462-5	10
CN3805-000	9	1-956299-4	16	6-1394462-3	10
CR0780-000	9	1-956299-5	16	6-1394462-4	10
CR0781-000	9	1-956299-6	16	1394739-1	13
CR0782-000	9	1394461-4	10	1534226-1	13
CR0783-000	9	1394461-7	10	1534611-1	13
CR0784-000	9	1394461-8	10	1534611-2	13
CR0785-000	9	6-1394461-1	10	1740277-1	13
CR0786-000	9	6-1394461-2	10	1740277-2	13
CR0787-000	9	6-1394461-3	10	1740479-1	14
CR0788-000	9	6-1394461-4	10	1740483-1	14
CR0789-000	9	6-1394461-5	10	1740483-2	14
CR0791-000	9	6-1394461-6	10	1740493-1	14
CR0792-000	9	7-1394461-0	10	1740493-2	14
956297-4	16	7-1394461-1	10	1740939-2	10
956297-5	16	7-1394461-2	10	1740939-4	10
956297-6	16	7-1394461-3	10	1740939-5	10
1-956297-4	16	7-1394461-4	10	1-1740939-2	10
1-956297-5	16	7-1394461-5	10	1740940-3	10
1-956297-6	16	4-1394462-6	10	1740940-4	10
956298-4	16	1394462-1	10	1-1740940-3	10
956298-5	16	1394462-2	10	1-1740940-4	10

PV Installers Numerical Index (Continued)
Tooling

Part Number	Page	Part Number	Page	Part Number	Page
1954283-1	8	2-1987376-4	18	174969-1	25
1954381-1	20	2-1987376-5	18	523229-1	25
1954381-2	20	3-1987376-1	18	539630-1	24
1986164-1	17	3-1987376-2	18	1102855-3	24,25
1986164-2	17	3-1987376-3	18	1-1579004-1	24
1986164-3	17	3-1987376-4	18	1-1579004-2	24,25
1986165-1	17	3-1987376-5	18	1534858-1	25
1986165-2	17	4-1987376-1	18	1579000-4	24
1986165-3	17	4-1987376-2	18	8-1579001-2	24
1986166-1	17	4-1987376-3	18	5-1579001-5	24
1986166-2	17	4-1987376-4	18	7-1579001-8	24
1986166-3	17	4-1987376-5	18	7-1579001-9	24
1987280-1	12	1987419-1	13	4-1579002-2	24,25
1987280-2	12	1987423-1	13	1579007-2	25
1987280-3	12	1987558-1	11	1579007-3	25
1987280-4	12	1987558-2	11	1579007-5	25
1987280-5	12	1987558-3	11	1673663-2	24
1987281-1	12	1-1987558-1	11	1740969-2	25
1987281-2	12	1-1987558-2	11	1740969-3	25
1987281-3	12	1-1987558-3	11	1855503-1	24
1987281-4	12	1987559-1	11	1855503-1	24
1987281-5	12	1987559-2	11	1855503-2	24
1987286-4	11	1-1987559-1	11	1855503-3	24
1987286-5	11	1-1987559-2	11	1855503-6	24
1987286-6	11	2058729-1	19	2063900-1	24
1987287-1	11	2106207-1	13	2063900-2	24
1987287-2	11	2106831-1	19		
2-1987376-3	18				



We are a leading manufacturer of electronic components and solutions for solar energy. Our growing presence in the photovoltaic and solar thermal industry is backed by our innovative, extensive and high quality products to meet your individual needs.

tycoelectronics.com/solar

FOR MORE INFORMATION

Technical Support

Internet:	www.tycoelectronics.com/help
USA:	+1 (800) 522-6752
Canada:	+1 (905) 470-4425
Mexico & Central America:	+52(O) 55-1106-0814
South America:	+55 (O) 11-2103-6000
Germany:	+49 (O) 6251-133-1999
UK:	+44 (O) 800-267666
France:	+33 (O) 1-3420-8686
Netherlands:	+31 (O) 73-6246-999
China:	+86 (O) 400-820-6015

Part numbers in this brochure are RoHS Compliant*, unless marked otherwise.
*as defined www.tycoelectronics.com/leadfree

Tyco Electronics Corporation
Berwyn, PA

www.tycoelectronics.com

© 2010 Tyco Electronics Corporation. All Rights Reserved.
3-1773458-6 CIS FP 3K 09/2010

SOLARLOK, TE (logo) and Tyco Electronics are trademarks of the Tyco Electronics group of companies and its licensors.
Other logos, product and Company names mentioned herein may be trademarks of their respective owners.

While Tyco Electronics has made every reasonable effort to ensure the accuracy of the information in this catalog, Tyco Electronics does not guarantee that it is error-free, nor does Tyco Electronics make any other representation, warranty or guarantee that the information is accurate, correct, reliable or current. Tyco Electronics reserves the right to make any adjustments to the information contained herein at any time without notice. Tyco Electronics expressly disclaims all implied warranties regarding the information contained herein, including, but not limited to, any implied warranties of merchantability or fitness for a particular purpose. The dimensions in this catalog are for reference purposes only and are subject to change without notice. Specifications are subject to change without notice. Consult Tyco Electronics for the latest dimensions and design specifications.

 **Tyco Electronics**
Our commitment. Your advantage.