



**Mini-Universal MATE-N-LOK Connectors**

**Product Facts**

- Compact, durable housings
- Pins and sockets can be accommodated in the same housings
- Contacts fully protected in the housings. Both pins and sockets can be used on the power supply wiring
- Fully polarized to provide proper plug-to-cap mating incorporating a positive locking mechanism to help prevent accidental disengagement of mated connectors. Also facilitates panel mounting
- Free hanging or panel mount
- Housings available in 1, 2, 3, 4, 6, 9, 12 and 15 circuit configuration for wire-to-wire connection
- Connectors can be mounted to .031-.079 [0.79-2.00] thick panels
- Printed circuit board pin headers are available in 2 thru 24 circuit vertical and right-angle configurations
- Hermaphroditic housings available in 2, 3 and 4 circuits for free hanging applications
- Low insertion/extraction forces
- Contacts accept wire size range 30-16 AWG [.05-1.2 mm<sup>2</sup>]
- Test probe contacts available
- .163 [4.14] centerline spacing
- Not for interrupting current
- Recognized under the Component Program of Underwriters Laboratories Inc., File No. E28476 
- Certified by Canadian Standards Association, File No. LR 7189 
- Passed test by VDE under their Registration Number 3476/ Continuous Surveillance 

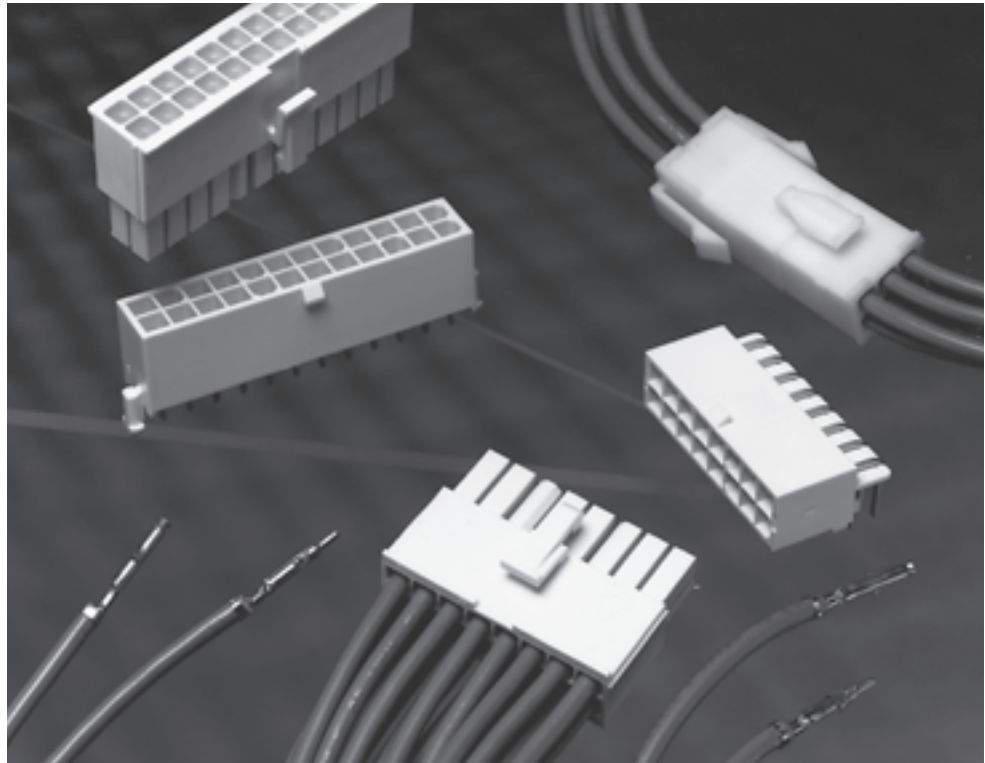

High Density  
.163 [4.14] Centerline

**Performance Characteristics**

The Mini-Universal MATE-N-LOK Connector performance characteristics found on pages 79-80 are based on free hanging and panel mount connectors, loaded with contacts crimped on stranded wire.

**Low Level Termination Resistance**  
20 milliohms max. total resistance between wire crimps of a mated pin and socket

**Dielectric Withstanding Voltage**—  
1.5 KVAC between adjacent circuits

**Insulation Resistance**—  
1000 megohms minimum between adjacent circuits

**Voltage Rating**—600 V AC or DC

**Contact Retention**—8 lb. min. per contact

**Durability**—20 cycles, mating and unmating

**Technical Documents**

- Product Specifications**
- 108-1542 Mini-Universal MATE-N-LOK Connectors
  - 108-1543 Mini-Universal MATE-N-LOK Headers
  - 108-5151 Mini-Universal MATE-N-LOK Connectors (UL94V-2)
  - 108-5138 Mini-Universal MATE-N-LOK Connectors (UL94V-0)

- Application Specification**
- 114-16017 Mini-Universal MATE-N-LOK Connectors

- Instruction Sheets**
- 408-3234 Mini-Universal MATE-N-LOK Connectors
  - 411-5105 Mini-Universal MATE-N-LOK Connectors

### Performance Characteristics (Continued)

**Maximum Current**—Maximum current rating of Mini-Universal MATE-N-LOK connectors is limited by the maximum operating temperature of the housings which is 105°C including the temperature rise of the contacts which is a maximum of 30°C. There are several variables which have a direct effect on this maximum current-carrying capability for a given connector and must be considered for each application. These variables are:

**Wire Size**—Larger diameter wire will carry more current since it has less internal resistance to current flow and thus generates less heat. Longer wire lengths also enhance current-carrying capabilities since the wire conducts heat away from the connector.

**Connector Size**—In general, the more circuits in a connector, the less current can be carried.

**Ambient Temperature**—The higher the ambient temperature, the less current can be carried in any given connector.

**Printed Wiring Board Conductor Size**—The finished trace conductor width and thickness should be maximized to allow for the greatest current-carrying capacity and heat dissipation.

Mini-Universal MATE-N-LOK connectors also will withstand the following tests:

**Housing Panel Retention**—  
26 lb. min.

**Housing Lock Strength**—6 lb. min.

**Thermal Shock**— -55°C to +105°C

**Temperature-Humidity Cycling**—  
25°C to 65°C at 95 RH

**Corrosion**—48 hr. at 5% salt concentration

**Vibration**—10-55-10 cycles per minute at .06 inch total excursion

**Physical Shock**—18 drops, 50 G half-sine at 11 milliseconds

### Mini-Universal MATE-N-LOK Connectors (Continued)

#### Current Rating Verification for 30°C Maximum Temperature Rise 100% Energized

#### Wire-to-Wire Mini-Universal MATE-N-LOK Connectors — Calculated Current Table

Number of Circuits	Wire AWG						
	16	18	20	22	24	26	30
2	9.50	9.00	7.50	6.00	5.00	4.00	3.00
3	8.50	8.00	7.00	5.50	4.50	4.00	3.00
4	8.00	7.00	6.00	5.00	4.50	3.50	2.50
6	7.00	6.50	5.50	4.50	4.00	3.00	2.50
9	6.00	5.50	4.50	4.00	3.50	3.00	2.00
12	6.00	5.50	4.50	3.50	3.00	2.50	2.00
15	5.50	5.00	4.00	3.50	3.00	2.50	2.00

Values are based on initial Temperature Rise versus Current Testing and are intended to be a guide in the selection of a connector family. All applications should be tested by the end user. The values listed are per circuit, for fully loaded housings being 100% energized. **Note:** All combinations above were not tested and this chart contains interpolated and extrapolated values.

#### Minimum Wire Lengths for T-Rise vs. Current Testing

AWG	Min. Length (in.)	AWG	Min. Length (in.)
30	2.6	18	9.4
28	3.2	16	11.3
26	4.1	14	13.7
24	5.1	12	16.4
20	7.8	10	19.3

**Note:** If wire lengths used are less than those listed above, the current-carrying ability of the system will be reduced due to less heat being conducted away from the connector. The customer should fully test all applications.

#### Wire-to-Board

Due to the vast differences in trace geometry and printed circuit board configurations, we are unable to provide a separate current carrying chart for our printed circuit board header products. However, the above Wire-to-Wire charts may be used as a guideline for headers if the trace width and thickness is equal to the listed wire gauge. For vertical headers, only 95% of the Wire-to-Wire value should be used. For right-angle headers, only 75% of the Wire-to-Wire value should be used. The chart values are only a tool for connector selection and will require the customer to fully test their application.

#### Termination Resistance/Contact Crimp Tensile Force

Wire Size		Termination Resistance		Contact Crimp Tensile Force	
AWG	mm <sup>2</sup>	Test Current (Amps)	Resistance Milliohms (Max. Init.)	Force (Min.)	
				lbs.	N
30	.05	—	—	—	—
28	.08	—	—	—	—
26	.12	—	—	4	18
24	.2	—	—	7	31
22	.3	—	—	11	49
20	.5	—	—	13	58
18	.8	—	—	15	67
16	1.2	—	—	18	80

**Mini-Universal MATE-N-LOK Connectors (Continued)**

**Mini-Universal MATE-N-LOK Connector Mating Combinations**

Connector Part Number					Mating Connector Part Number				
Number of Circuits	Flammability Rating	Style	Plug <sup>1</sup> Housing Part No.	Cap <sup>1</sup> Housing Part No.	PC Board Pin Headers			Right-Angle With Board Lock	
					Plating	With Drain Holes	Vertical Without Drain Holes		Blindmate
1	UL94V-2	In-Line	172335-1 <sup>3</sup>	172327-1 <sup>4</sup>	—	—	—	—	
	UL94V-0	In-Line	172164-1 <sup>3</sup>	172156-1 <sup>4</sup>	Tin <sup>6</sup>	—	—	1-794374-0	
					Duplex <sup>5</sup>	—	—	1-794374-1	
2	UL94V-2	In-Line	172336-1 <sup>3</sup>	172328-1 <sup>2</sup>	—	—	—	—	
			172807-1 <sup>3</sup>	172343-1 <sup>4</sup>	—	—	—	—	
			173956-1 <sup>3</sup>	172807-1 <sup>3</sup>	—	—	—	—	
	UL94V-0	In-Line	172165-1 <sup>3</sup>	172157-1 <sup>2</sup>	Tin <sup>6</sup>	1-770166-0	1-770872-0	—	1-770966-0
			794894-1 <sup>7</sup>	172233-1 <sup>4</sup>	Duplex <sup>5</sup>	1-770166-1	1-770872-1	—	1-770966-1
			172808-1 <sup>3</sup>	794896-1 <sup>7</sup>	Tin/Duplex	1-770166-1	1-770872-1	—	1-770966-1
3	UL94V-2	In-Line	172337-1 <sup>2</sup>	172329-1 <sup>2</sup>	—	—	—	—	
			173957-1 <sup>3</sup>	172344-1 <sup>4</sup>	Duplex <sup>5</sup>	—	—	—	—
				173957-1 <sup>3</sup>	—	—	—	—	—
	UL94V-0	In-Line	172166-1 <sup>3</sup>	172158-1 <sup>2</sup>	Tin	1-770170-0	1-770873-0	—	1-770967-0
			172809-1 <sup>3</sup>	172234-1 <sup>4</sup>	Duplex <sup>5</sup>	1-770170-1	1-770873-1	—	1-770967-1
			172338-1 <sup>3</sup>	172809-1 <sup>3</sup>	—	—	—	—	—
4	UL94V-2	Dual Row	172958-1 <sup>3</sup>	172330-1 <sup>3</sup>	—	—	—	—	
				172339-1 <sup>3</sup>	—	—	—	—	
				172958-1 <sup>3</sup>	—	—	—	—	
	UL94V-0	Dual Row	172167-1 <sup>3</sup>	172159-1 <sup>3</sup>	Tin	1-770174-0	1-770874-0	1-794325-0	1-770968-0
			794805-1 <sup>7</sup>	794939-1 <sup>74</sup>	Duplex <sup>5</sup>	1-770174-1	1-770874-1	1-794325-1	1-770968-1
			172339-1 <sup>3</sup>	172331-1 <sup>3</sup>	Tin/Duplex	1-770174-1	1-770874-1	—	1-770968-1
6	UL94V-2	Dual Row	172168-1 <sup>3</sup>	172160-1 <sup>3</sup>	Tin	1-770178-0	1-770875-0	1-794326-0	1-770969-0
			794895-1 <sup>7</sup>	794940-1 <sup>74</sup>	Duplex <sup>5</sup>	1-770178-1	1-770875-1	1-794326-1	1-770969-1
					Tin/Duplex	1-770178-1	1-770875-1	—	1-770969-1
	UL94V-0	Dual Row	770579-1 <sup>3</sup>	—	Tin	1-794065-0	1-794073-0	1-794327-0	1-770970-0
			794821-1 <sup>7</sup>	794941-1 <sup>74</sup>	Duplex <sup>5</sup>	1-794065-1	1-794073-1	1-794327-1	1-770970-1
			172340-1 <sup>3</sup>	172332-1 <sup>3</sup>	Tin/Duplex	1-794065-1	1-794073-1	—	1-770970-1
9	UL94V-2	Matrix	172169-1 <sup>3</sup>	172161-1 <sup>3</sup>	Tin	1-770182-0	1-770876-0	1-794432-0	—
					Duplex <sup>5</sup>	1-770182-1	1-770876-1	1-794432-1	—
					Tin	1-770743-0	1-770858-0	1-794328-0	1-770971-0
	UL94V-0	Dual Row	770580-1 <sup>3</sup>	—	Duplex <sup>5</sup>	1-770743-1	1-770858-1	1-794328-1	1-770971-1
			794781-1 <sup>7</sup>	794942-1 <sup>74</sup>	Tin/Duplex	1-770743-1	1-770858-1	—	1-770971-1
			172341-1 <sup>3</sup>	172333-1 <sup>3</sup>	—	—	—	—	—
12	UL94V-2	Matrix	172170-1 <sup>3</sup>	172162-1 <sup>3</sup>	Tin	1-770186-0	1-794040-0	1-794329-0	—
					Duplex <sup>5</sup>	1-770186-1	1-794040-1	1-794329-1	—
					Tin	1-794066-0	1-770621-0	—	1-770972-0
	UL94V-0	Dual Row	770581-1 <sup>3</sup>	—	Duplex <sup>5</sup>	1-794066-1	1-770621-1	—	1-770972-1
					Tin	1-794067-0	1-794074-0	—	1-770973-0
					Duplex <sup>5</sup>	1-794067-1	1-794074-1	—	1-770973-1
15	UL94V-2	Matrix	172342-1 <sup>3</sup>	172334-1	—	—	—	—	
					Tin	1-770190-0	1-770859-0	1-794330-0	—
					Duplex <sup>5</sup>	1-770190-1	1-770859-1	1-794330-1	—
	UL94V-0	Dual Row	770583-1	—	Tin	1-794068-0	1-794075-0	—	1-770974-0
					Duplex <sup>5</sup>	1-794068-1	1-794075-1	—	1-770974-1
					Tin	1-794069-0	1-794076-0	—	1-794105-0
18	UL94V-2	Matrix	770584-1	—	Duplex <sup>5</sup>	1-794069-1	1-794076-1	—	1-794105-1
					Tin	1-794070-0	1-794077-0	—	1-794106-0
					Duplex <sup>5</sup>	1-794070-1	1-794077-1	—	1-794106-1
	UL94V-0	Dual Row	770585-1	—	Tin	1-794071-0	1-794078-0	—	1-794107-0
					Duplex <sup>5</sup>	1-794071-1	1-794078-1	—	1-794107-1
					Tin	1-794072-0	1-794079-0	—	1-794108-0
UL94V-0	Dual Row	770586-1	—	Duplex <sup>5</sup>	1-794072-1	1-794079-1	—	1-794108-1	
				—	—	—	—	—	

<sup>1</sup>Mini-Universal MATE-N-LOK plug and cap housings accept pin or socket contacts. Use the appropriate contacts in the plug housing as required by the mating connector. All **Plugs** are **free hanging** and **Caps** are **free hanging or panel mount**, unless otherwise noted.

<sup>2</sup>Panel mount only.

<sup>3</sup>Hermaphroditic: Mates to itself.

<sup>4</sup>Free hanging only.

<sup>5</sup>Duplex Finish—Plated with .000030 [.000762] min. gold in mating area and matte tin on solder tail end over .000050 [.00127] min. nickel underplate on entire contact.

<sup>6</sup>Tin Finish—Plated with .000150 [.00381] min. tin over .000050 [.00127] min. nickel underplate on entire contact.

<sup>7</sup>For Splash-Proof Sealing.

**Note: All part numbers are RoHS Compliant.**

**Mini-Universal MATE-N-LOK Connectors (Continued)**

**Contacts**

Pin diameter .039 [0.99]

**Material**

Brass or Phosphor bronze  
Stock Thickness .008 [0.20]  
These contacts are to be used in Mini-Universal MATE-N-LOK Plug or Cap housings only.

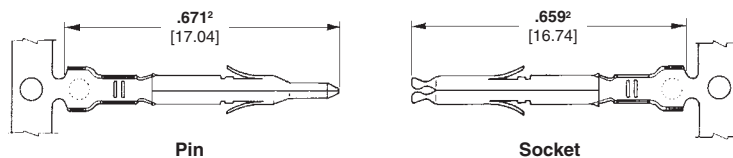

**Related Product Data**

**Product Specifications**

108-1542 Mini-Universal MATE-N-LOK Connectors  
108-1543 Mini-Universal MATE-N-LOK Headers

**Application Specification**

114-16017 Mini-Universal MATE-N-LOK Connectors

**Performance Characteristics**

pages 79-80

**Housings** — pages 83-85

**Technical Documents** — pages 79 and 199-200

**Application Tooling** — pages 201-204

Wire Size Range AWG [mm <sup>2</sup> ]	Ins. Dia. Range	Material and Finish	Contact Part Numbers				HDM Applicator Part No.	Hand Tool Part No.
			Pin		Socket			
			Strip Form	Loose Pieces	Strip Form	Loose Pieces		
30-26 [.05-.12]	.035-.050 [.889-1.27]	Brass, Pre-tin	770835-1	794059-1	770834-1	794058-1	567418-1 <sup>3</sup>	90717-2
		Phos. Brz., Pre-tin	—	—	770834-4	—	567418-2 <sup>3</sup>	
		Brass, Duplex <sup>1</sup>	1-770835-0	1-794059-0	1-770834-0	1-794058-0	567418-3 <sup>3</sup>	
26-22 [.12-.3]	.047-.069 [1.19-1.75]	Brass, Pre-tin	770901-1	770985-1	770902-1	770986-1	567066-3 <sup>4</sup>	91529-1
		Phos. Brz., Pre-tin	—	—	1-770902-4	—	567066-4 <sup>4</sup>	
		Brass, Duplex <sup>1</sup>	1-770901-0	1-770985-0	1-770902-0	1-770986-0	567066-5 <sup>4</sup>	
22-18 [.3-.8] or 22 x (2) [.3]	.059-.094 [1.50-2.39] or .067 x (2) [3.38]	Brass, Pre-tin	770903-1	770987-1	770904-1	770988-1	567067-1 <sup>3</sup>	91522-1
		Phos. Brz., Pre-tin	—	—	770904-4	—	567067-2 <sup>3</sup>	
		Brass, Duplex <sup>1</sup>	1-770903-0	1-770987-0	1-770904-0	1-770988-0	567067-3 <sup>3</sup>	
20-16 [.5-1.2] or 20 x (2) [.5]	.079-.126 [2.01-3.20] or .075 x (2) [1.91]	Brass, Pre-tin	794406-1 <sup>2</sup>	171638-1 <sup>2</sup>	794407-1 <sup>2</sup>	171639-1 <sup>2</sup>	680582-2 <sup>3</sup>	91536-1
		Phos. Brz., Pre-tin	—	—	794407-4 <sup>2</sup>	—	680582-3 <sup>3</sup>	
		Brass, Duplex <sup>1</sup>	1-794406-0 <sup>2</sup>	—	1-794407-0 <sup>2</sup>	—	680582-3 <sup>3</sup>	
		Phos. Brz., Duplex <sup>1</sup>	—	—	1-794407-1 <sup>2</sup>	—	—	

<sup>1</sup> Duplex Finish — Plated with .000030 [.000762] min. gold in mating area and .000100 [.00254] min. tin in crimping area over .000050 [.00127] min. nickel underplate on entire contact.

<sup>2</sup> .671 [17.04] and .659 [16.74] dimensions are .689 [17.50] for indicated part numbers.

<sup>3</sup> HDM Applicator part number ending in -1 is used on AMPOMATOR CLS Machine with T or G Terminators, -2 is used on AMP-O-LECTRIC Model K Machine, -3 is used on AMP-O-ELECTRIC Model G Machine. See pages 201-204 for further information.

<sup>4</sup> HDM Applicator part number ending in -3 is used on AMPOMATOR CLS Machine with T or G Terminators, -4 is used on AMP-O-LECTRIC Model K Machine, -5 is used on AMP-O-LECTRIC Model G Machine. See pages 201-204 for further information.

**Note: All part numbers are RoHS Compliant.**

**Keying Plug**

**Material**

UL94V-0 Nylon, white color

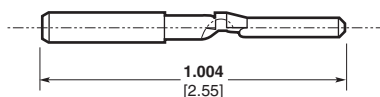

Part Number  
174670-1

**Test Probe Contact**

**Material and Finish**

Phosphor bronze, nickel plated

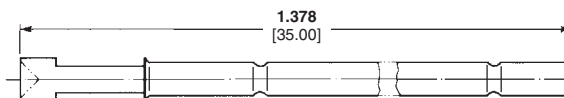

Part Number  
172971-1

**Notes:**

1. The test probe is inserted into the housing in the same direction as indicated by the arrow shown to the right.
2. The test probe can be used in the Cap or Plug Housing.
3. Test probes are supplied unassembled.

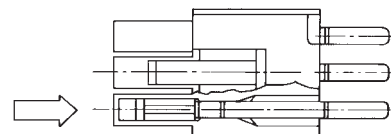

Contact Extraction Tool  
No. 189727-1  
IS 408-4118



Contact Insertion Tool  
(For inserting contacts applied to small diameter wire)  
No. 91002-1  
IS 408-7347

Mini-Universal MATE-N-LOK Connectors (Continued)

**Housings**

**Free Hanging or Panel Mount**

.163 [4.14] Centerline spacing

**Related Product Data**

**Product Specifications**

108-1542 Mini-Universal MATE-N-LOK Connectors

108-1543 Mini-Universal MATE-N-LOK Headers

108-5151 Mini-Universal MATE-N-LOK Connectors (UL94V-2)

108-5138 Mini-Universal MATE-N-LOK Connectors (UL94V-0)

**Performance Characteristics**— pages 79-80

**Contacts** — page 82

**Keying Plug** — page 82

**Test Probe Contact** — page 82

**Panel Cutout Recommendations**— page 85

**Technical Documents**— pages 79 and 199-200

**Mating Headers** — pages 86-88

**1 Circuit, Free Hanging**

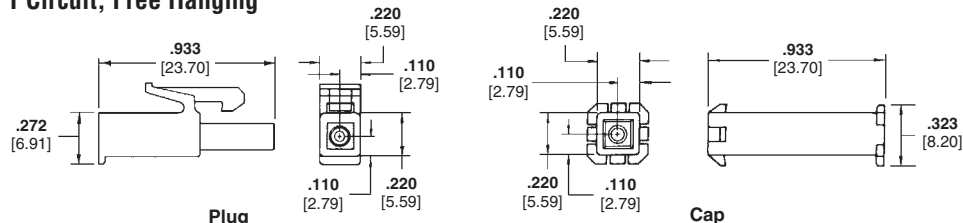

**2 and 3 Circuit, In-Line**

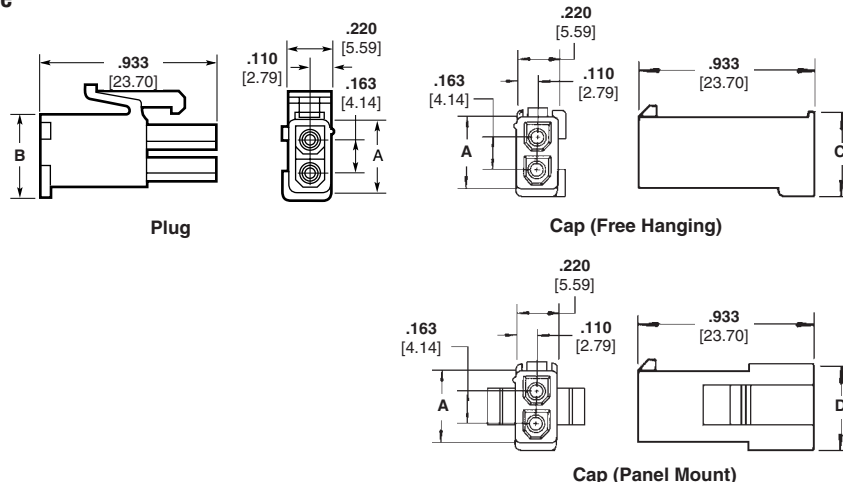

High Density  
.163 [4.14] Centerline

Number of Circuits	Dimensions				Housing Part Numbers <sup>1</sup>					
					UL94V-0 Nylon, White Color			UL94V-2 Nylon, Natural Color		
	A	B	C	D	Plug	Cap		Plug	Cap	
1	—	—	—	—	172164-1	—	172156-1	172335-1	—	172327-1
2	.386 9.80	.425 10.79	.488 12.39	.464 11.78	172165-1	172157-1	172233-1	172336-1	172328-1	172343-1
3	.551 14.00	.591 15.01	.654 16.61	.630 16.00	172166-1	172158-1	172234-1	172337-1	172329-1	172344-1

Note: All part numbers are RoHS Compliant.

**4 and 6 Circuit, Dual Row**

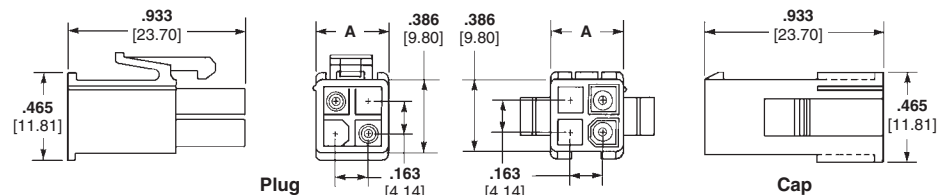

Number of Circuits	A Dim.	Housing Part Numbers <sup>1</sup>			
		UL94V-0 Nylon, White Color		UL94V-2 Nylon, Natural Color	
		Plug	Cap	Plug	Cap
4	.386 9.80	172167-1	172159-1	172338-1	172330-1
6	.551 14.00	172168-1	172160-1	172339-1	172331-1

<sup>1</sup>Housing part numbers shown in both charts (above) are also available in other colors: Red, Green, Blue, Black. To order connectors in these colors use the appropriate dash numbers as follows: Red 1-XXXXXX-2, Green 1-XXXXXX-5, Blue 1-XXXXXX-6, Black 1-XXXXXX-9

Note: All part numbers are RoHS Compliant.

**Mini-Universal MATE-N-LOK Connectors (Continued)**

**Housings**

.163 [4.14] Centerline spacing

**Related Product Data**

- Product Specifications**  
 108-1542 Mini-Universal MATE-N-LOK Connectors  
 108-1543 Mini-Universal MATE-N-LOK Headers  
 108-5151 Mini-Universal MATE-N-LOK Connectors (UL94V-2)  
 108-5138 Mini-Universal MATE-N-LOK Connectors (UL94V-0)

**Performance Characteristics**— pages 79-80

**Contacts** — page 82

**Keying Plug** — page 82

**Test Probe Contact** — page 82

**Panel Cutout Recommendations**— page 85

**Technical Documents**— pages 79 and 199-200

**Mating Headers** — pages 86-88

**9, 12 and 15 Circuit, Free Hanging or Panel Mount, Matrix**

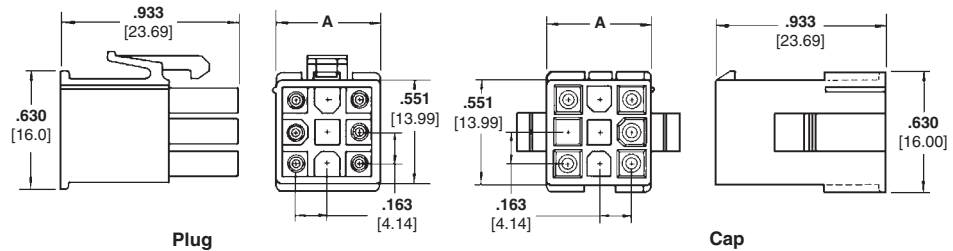

Number of Circuits	A Dim.	Housing Part Numbers <sup>1</sup>			
		UL94V-0 Nylon, White Color		UL94V-2 Nylon, Natural Color	
		Plug	Cap	Plug	Cap
9	.551 13.99	172169-1	172161-1	172340-1	172332-1
12	.716 18.19	172170-1	172162-1	172341-1	172333-1
15	.882 22.40	172171-1	172163-1	172342-1	172334-1

<sup>1</sup>Housing part numbers shown in chart are also available in other colors: Red, Green, Blue, Black. To order connectors in these colors use the appropriate dash numbers as follows: Red 1-XXXXXX-2, Green 1-XXXXXX-5, Blue 1-XXXXXX-6, Black 1-XXXXXX-9

**Note:** All part numbers are RoHS Compliant.

**8 thru 24 Circuit, Free Hanging, Dual Row**

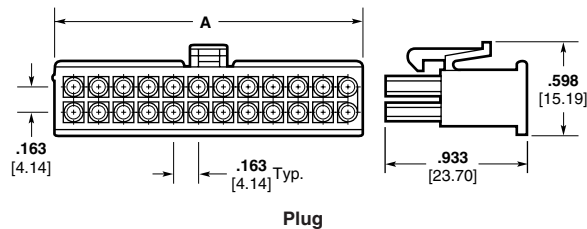

Number of Circuits	A Dim.	Part Number UL94V-0 Nylon, White Color Plug
8	.714 18.14	770579-1
10	.877 22.28	770580-1
12	1.040 26.42	770581-1
14	1.203 30.56	770582-1
16	1.366 34.70	770583-1
18	1.529 38.84	770584-1
20	1.692 42.98	770585-1
22	1.855 47.12	770586-1
24	2.018 51.26	770587-1

**Note:** All part numbers are RoHS Compliant.



**Housings**  
**Hermaphroditic**  
**Free Hanging**

**Related Product Data**

- Product Specifications**  
108-1542 Mini-Universal MATE-N-LOK Connectors  
108-1543 Mini-Universal MATE-N-LOK Headers  
108-5151 Mini-Universal MATE-N-LOK Connectors (UL94V-2)  
108-5138 Mini-Universal MATE-N-LOK Connectors (UL94V-0)

- Performance Characteristics** — pages 79-80  
**Contacts** — page 82  
**Cap Housings** — pages 83-85  
**Technical Documents** — pages 79 and 199-200

**2, 3 and 4 Circuit**

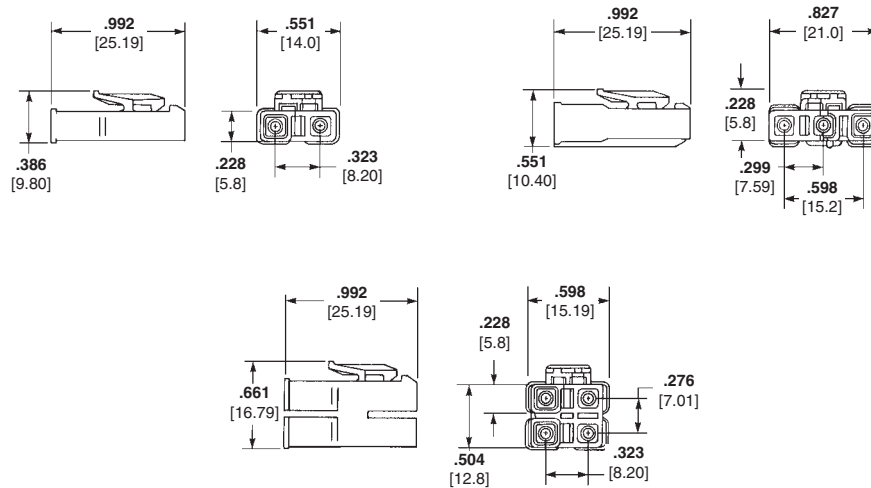

Number of Circuits	Part Numbers	
	UL94V-2 Nylon, Natural Color	UL94V-0 Nylon, White Color
2	172807-1	—
3	172808-1	173957-1
4	172809-1	—

**Note:** Housing mates to itself; 2 required per wire-to-wire connection.

**Note:** All part numbers are RoHS Compliant.

**Recommended Cap Housing Panel Cutouts**

View is from cap entry side  
Recommended Panel Thickness .031—.079 [.79 – 2.01]

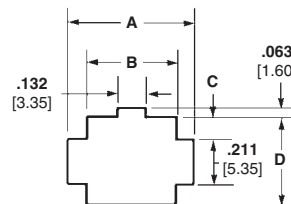

Number of Circuits	Dimensions			
	A	B	C	D
2	.421 10.69	.242 6.15	.098 2.49	.407 10.3
3	.421 10.69	.242 6.15	.181 4.60	.573 14.55
4	.587 14.91	.407 10.34	.098 2.49	.407 10.3
6	.752 19.10	.573 14.55	.098 2.49	.407 10.3
9	.752 19.10	.573 14.55	.181 4.60	.573 14.55
12	.917 23.29	.738 18.75	.181 4.60	.573 14.55
15	1.080 27.43	.904 22.96	.181 4.60	.573 14.55

High Density  
.163 [4.14] Centerline

**Mini-Universal MATE-N-LOK Connectors (Continued)**

**Vertical PC Board  
Pin Headers**

.163 [4.14] Centerline spacing

**Material**

**Housing** — Nylon, white

**Flammability Rating** — UL94V-0

**Contacts** — Brass

Solder tail diameter .039 [1.00]

**Related Product Data**

**Product Specifications**

108-1542 Mini-Universal MATE-N-LOK Connectors

108-1543 Mini-Universal MATE-N-LOK Headers

108-5151 Mini-Universal MATE-N-LOK Connectors (UL94V-2)

108-5138 Mini-Universal MATE-N-LOK Connectors (UL94V-0)

**Performance Characteristics** — pages 79-80

**Recommended PC Board Hole**

**Layouts** — page 89

**Technical Documents** — pages 79 and 199-200

**Mating Connectors**

**Mini-Universal MATE-N-LOK**

Plug Housings — pages 83-85

**Mini-Universal MATE-N-LOK 2**

Plug Housings — pages 95-96

**2 and 3 Circuit, In-Line**

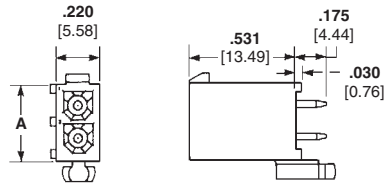

**4, 6, 8, 10 and 12 Circuit, Dual Row**

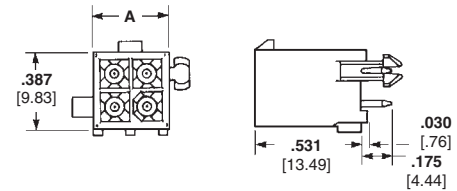

**9, 12 and 15 Circuit, Matrix**

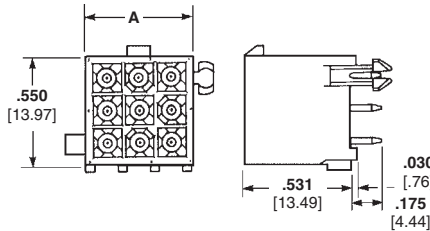

**14, 16, 18, 20, 22 and 24 Circuit, Dual Row**

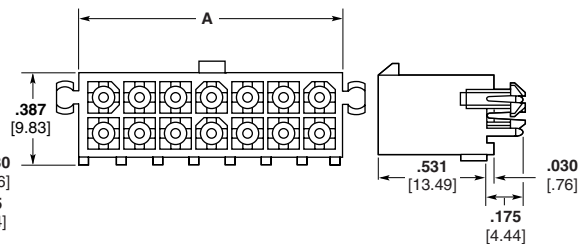

Number of Circuits	Style	A Dim.	Pin Finish	Vertical Pin Header Part Numbers		Mates with Plug Housing Part Number (Using Socket Contact)	
				With Drain Holes	Without Drain Holes	Mini-Universal MATE-N-LOK	Mini-Universal MATE-N-LOK 2
2	In-Line	.387 9.83	Tin <sup>1</sup>	1-770166-0	1-770872-0	172165-1	794184-1
			Duplex <sup>2</sup>	1-770166-1	1-770872-1		
3	In-Line	.550 13.97	Tin <sup>1</sup>	1-770170-0	1-770873-0	172166-1	794186-1
			Duplex <sup>2</sup>	1-770170-1	1-770873-1		
4	Dual Row	.387 9.83	Tin <sup>1</sup>	1-770174-0	1-770874-0	172167-1	794188-1
			Duplex <sup>2</sup>	1-770174-1	1-770874-1		
6	Dual Row	.550 13.97	Tin <sup>1</sup>	1-770178-0	1-770875-0	172168-1	794190-1
			Duplex <sup>2</sup>	1-770178-1	1-770875-1		
8	Dual Row	.713 18.11	Tin <sup>1</sup>	1-794065-0	1-794073-0	770579-1	794192-1
			Duplex <sup>2</sup>	1-794065-1	1-794073-1		
9	Matrix	.551 14.00	Tin <sup>1</sup>	1-770182-0	1-770876-0	172169-1	794194-1
			Duplex <sup>2</sup>	1-770182-1	1-770876-1		
10	Dual Row	.877 22.28	Tin <sup>1</sup>	1-770743-0	1-770858-0	770580-1	794196-1
			Duplex <sup>2</sup>	1-770743-1	1-770858-1		
12	Dual Row	1.039 26.39	Tin <sup>1</sup>	1-794066-0	1-770621-0	770581-1	794198-1
			Duplex <sup>2</sup>	1-794066-1	1-770621-1		
12	Matrix	.713 18.11	Tin <sup>1</sup>	1-770186-0	1-794040-0	172170-1	794200-1
			Duplex <sup>2</sup>	1-770186-1	1-794040-1		
14	Dual Row	1.202 30.53	Tin <sup>1</sup>	1-794067-0	1-794074-0	770582-1	794202-1
			Duplex <sup>2</sup>	1-794067-1	1-794074-1		
15	Matrix	.877 22.28	Tin <sup>1</sup>	1-770190-0	1-770859-0	172171-1	794204-1
			Duplex <sup>2</sup>	1-770190-1	1-770859-1		
16	Dual Row	1.365 34.67	Tin <sup>1</sup>	1-794068-0	1-794075-0	770583-1	794206-1
			Duplex <sup>2</sup>	1-794068-1	1-794075-1		
18	Dual Row	1.528 38.81	Tin <sup>1</sup>	1-794069-0	1-794076-0	770584-1	794208-1
			Duplex <sup>2</sup>	1-794069-1	1-794076-1		
20	Dual Row	1.691 42.95	Tin <sup>1</sup>	1-794070-0	1-794077-0	770585-1	794210-1
			Duplex <sup>2</sup>	1-794070-1	1-794077-1		
22	Dual Row	1.854 47.09	Tin <sup>1</sup>	1-794071-0	1-794078-0	770586-1	794212-1
			Duplex <sup>2</sup>	1-794071-1	1-794078-1		
24	Dual Row	2.017 51.23	Tin <sup>1</sup>	1-794072-0	1-794079-0	770587-1	794214-1
			Duplex <sup>2</sup>	1-794072-1	1-794079-1		

<sup>1</sup> Tin Finish—Plated with .000150 [.00381] min. tin over .000050 [.00127] min. nickel underplate on entire contact.

<sup>2</sup> Duplex Finish—Plated with .000030 [.000762] min. gold in mating area and matte tin on solder tail end over .000050 [.00127] min. nickel underplate on entire contact.

**Note:** All part numbers are RoHS Compliant.



**Vertical PC Board  
Blindmate Pin Headers**

.163 [4.14] Centerline spacing

**Material**

**Housing** — Nylon, white

**Flammability Rating** — UL94V-0

**Contacts** — Brass

Solder tail diameter .039 [1.00]

**Related Product Data**

**Product Specifications**

108-1693 Mini-Universal MATE-N-LOK 2 Connectors

108-1694 Mini-Universal MATE-N-LOK 2 Headers

**Performance Characteristics** — pages 79-80

**Recommended PC Board Hole Layouts** — page 89

**Technical Documents** — pages 79 and 199-200

**Mating Connectors**

**Mini-Universal MATE-N-LOK**

Plug Housings — pages 83-85

**Mini-Universal MATE-N-LOK 2**

Plug Housings — pages 95-96

**Mini-Universal MATE-N-LOK Connectors (Continued)**

**4, 6, 8 and 10 Circuit,  
Dual Row**

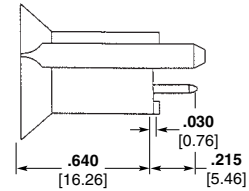
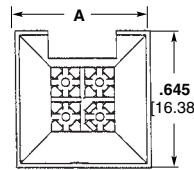

**9, 12 and 15 Circuit,  
Matrix**

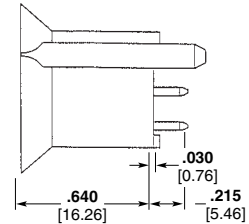
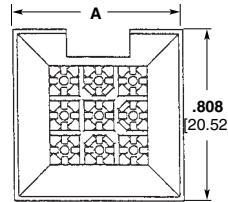

Number of Circuits	Style	A Dim.	Pin Finish	Pin Header Part Numbers With Drain Holes	Mates with Plug Housing Part Number (Using Socket Contacts)	
					Mini-Universal MATE-N-LOK	Mini-Universal MATE-N-LOK 2
4	Dual Row	.645 16.38	Tin <sup>1</sup>	1-794325-0	172167-1	794188-1
			Duplex <sup>2</sup>	1-794325-1		
6	Dual Row	.808 20.52	Tin <sup>1</sup>	1-794326-0	172168-1	794190-1
			Duplex <sup>2</sup>	1-794326-1		
8	Dual Row	.971 24.66	Tin <sup>1</sup>	1-794327-0	770579-1	794192-1
			Duplex <sup>2</sup>	1-794327-1		
9	Matrix	.808 20.52	Tin <sup>1</sup>	1-794432-0	172169-1	794194-1
			Duplex <sup>2</sup>	1-794432-1		
10	Dual Row	1.134 28.80	Tin <sup>1</sup>	1-794328-0	770580-1	794196-1
			Duplex <sup>2</sup>	1-794328-1		
12	Matrix	.971 24.66	Tin <sup>1</sup>	1-794329-0	172170-1	794200-1
			Duplex <sup>2</sup>	1-794329-1		
15	Matrix	1.134 28.80	Tin <sup>1</sup>	1-794330-0	172171-1	794204-1
			Duplex <sup>2</sup>	1-794330-1		

<sup>1</sup> Tin Finish — Plated with .000150 [.00381] min. tin over .000050 [.00127] min. nickel underplate on entire contact.

<sup>2</sup> Duplex Finish — Plated with .000030 [.000762] min. gold in mating area and matte tin on solder tail end over .000050 [.00127] min. nickel underplate on entire contact.

**Note:** All part numbers are RoHS Compliant.

High Density  
.163 [4.14] Centerline

**Right-Angle PC Board Pin Headers**

.163 [4.14] Centerline spacing

**Material**

**Housing** — Nylon, white color

**Flammability Rating** — UL94V-0

**Contacts** — Brass

Solder tail diameter .039 [1.00]

**Related Product Data**

**Product Specification**

108-1694 Mini-Universal  
MATE-N-LOK 2 Headers

**Performance Characteristics** —  
pages 79-80

**Recommended PC Board Hole  
Layouts** — page 89

**Technical Documents** — pages 79  
and 199-200

**Mating Connectors**

**Mini-Universal MATE-N-LOK**

Plug Housings — pages 83-85

**Mini-Universal MATE-N-LOK 2**

Plug Housings — pages 95-96

**Mini-Universal MATE-N-LOK Connectors (Continued)**

**With Board Lock Feature**

**1, 2 and 3 Circuit, In-Line**

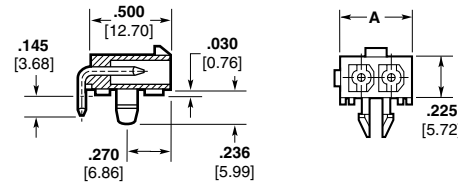

**4, 6, 8, 10 and 12 Circuit, Dual Row**

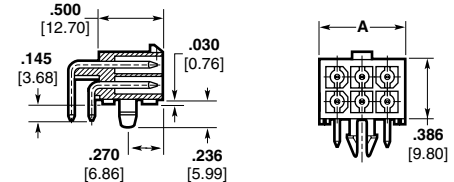

**14, 16, 18, 20, 22 and 24 Circuit, Dual Row**

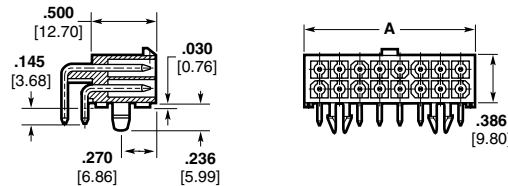

Number of Circuits	Style	A Dim.	Pin Finish	Pin Header Part Number With Board Lock	Mates with Plug Housing Part Number (Using Socket Contacts)	
					Mini-Universal MATE-N-LOK	Mini-Universal MATE-N-LOK 2
1	—	.225 5.72	Tin <sup>1</sup>	1-794374-0	172164-1	—
			Duplex <sup>2</sup>	1-794374-1		
2	In-Line	.388 9.86	Tin <sup>1</sup>	1-770966-0	172165-1	794184-1
			Duplex <sup>2</sup>	1-770966-1		
3	In-Line	.551 14.00	Tin <sup>1</sup>	1-770967-0	172166-1	794186-1
			Duplex <sup>2</sup>	1-770967-1		
4	Dual Row	.388 9.86	Tin <sup>1</sup>	1-770968-0	172167-1	794188-1
			Duplex <sup>2</sup>	1-770968-1		
6	Dual Row	.551 14.00	Tin <sup>1</sup>	1-770969-0	172168-1	794190-1
			Duplex <sup>2</sup>	1-770969-1		
8	Dual Row	.714 18.14	Tin <sup>1</sup>	1-770970-0	770579-1	794192-1
			Duplex <sup>2</sup>	1-770970-1		
10	Dual Row	.877 22.28	Tin <sup>1</sup>	1-770971-0	770580-1	794196-1
			Duplex <sup>2</sup>	1-770971-1		
12	Dual Row	1.040 26.42	Tin <sup>1</sup>	1-770972-0	770581-1	794198-1
			Duplex <sup>2</sup>	1-770972-1		
14	Dual Row	1.203 30.56	Tin <sup>1</sup>	1-770973-0	770582-1	794202-1
			Duplex <sup>2</sup>	1-770973-1		
16	Dual Row	1.366 34.70	Tin <sup>1</sup>	1-770974-0	770583-1	794206-1
			Duplex <sup>2</sup>	1-770974-1		
18	Dual Row	1.529 38.84	Tin <sup>1</sup>	1-794105-0	770584-1	794208-1
			Duplex <sup>2</sup>	1-794105-1		
20	Dual Row	1.692 42.98	Tin <sup>1</sup>	1-794106-0	770585-1	794210-1
			Duplex <sup>2</sup>	1-794106-1		
22	Dual Row	1.855 47.12	Tin <sup>1</sup>	1-794107-0	770586-1	794212-1
			Duplex <sup>2</sup>	1-794107-1		
24	Dual Row	2.018 51.26	Tin <sup>1</sup>	1-794108-0	770587-1	794214-1
			Duplex <sup>2</sup>	1-794108-1		

<sup>1</sup>Tin Finish — Plated with .000150 [.00381] min. tin over .000050 [.00127] min. nickel underplate on entire contact.

<sup>2</sup>Duplex Finish — Plated with .000030 [.000762] min. gold in mating area and matte tin on solder tail end over .000050 [.00127] min. nickel underplate on entire contact.

**Note:** All part numbers are RoHS Compliant.

**Recommended PC Board Hole Layouts for Vertical and Blindmate Headers**

.062 [1.57] thick board, tolerances non-accumulative

**Related Product Data**

Vertical Headers—pages 86-87

**2 and 3 Circuit, In-Line**

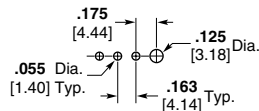

**4, 6, 8, 10 and 12 Circuit, Dual Row**

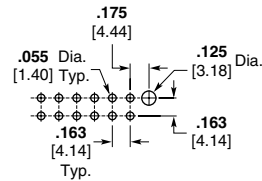

**9, 12 and 15 Circuit, Matrix**

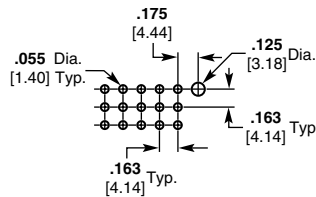

**14, 16, 18, 20, 22 and 24 Circuit, Dual Row**

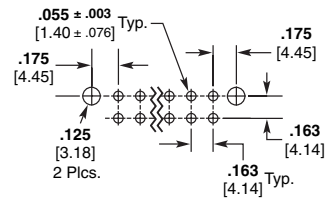

**Recommended PC Board Hole Layouts for Right-Angle Headers**

.062 [1.57] thick board, tolerances non-accumulative

**Related Product Data**

Right-Angle Headers—page 88

**1 Circuit**

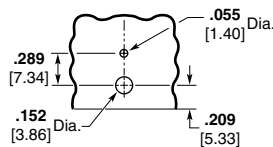

**2 Circuit, In-Line**

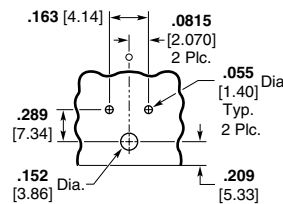

**3 Circuit, In-Line**

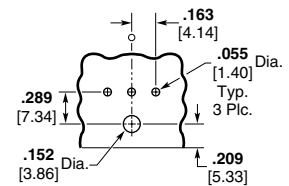

**4, 8 and 12 Circuit, Dual Row**

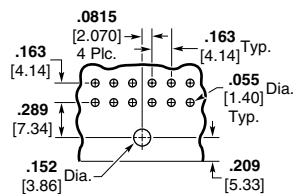

**6 and 10 Circuit, Dual Row**

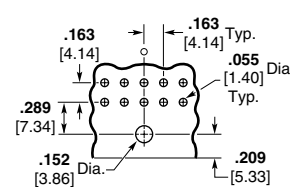

**14 and 18 Circuit, Dual Row**

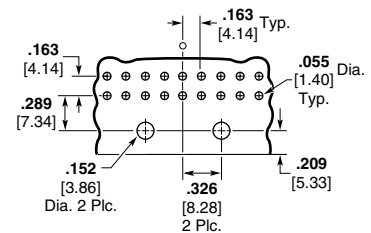

**22 Circuit, Dual Row**

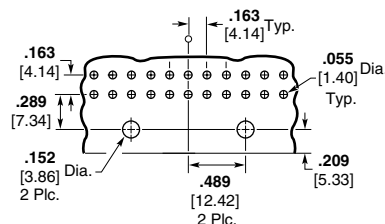

**16, 20 and 24 Circuit, Dual Row**

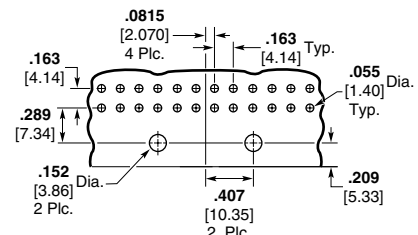

High Density  
.163 [4.14] Centerline

**Strain Reliefs for Plug or Cap Housings**

**6 and 8 Circuit**

**Related Product Data**

**Housings**—pages 83-85  
**Technical Documents**—pages 79 and 199-200

These Strain Reliefs may also be used with AMP-DUAC Receptacle housings on page 120.

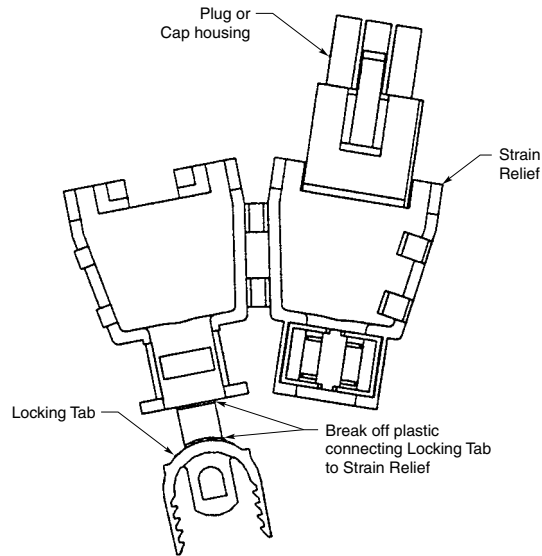

**Step 1**

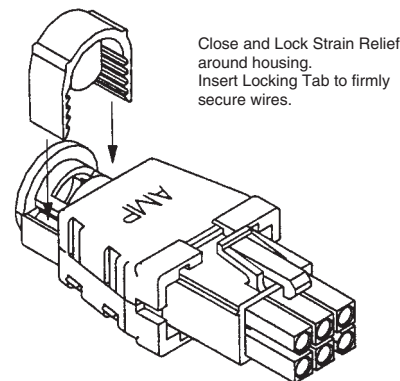

**Step 2**

Style	Number of Circuits	A Dim.	Wire Bundle Dia. Range	Part Numbers
				UL94V-0 Nylon, White Color
Dual Row	6	.920 23.36	.165-.220 4.19-5.59	794423-1
	8	.920 23.36	.180-.245 4.57-6.22	794370-1

**Note:** All part numbers are RoHS Compliant.

**Mini-Universal MATE-N-LOK Sealed Connector System**

**Product Facts —  
Sealed Connector System**

- Splash-proof design allows use in areas where high humidity, intermittent liquid splashing or foam-in applications require a sealed connector for improved electrical performance
- Wire-to-wire and wire-to-board
- Dual row, 2 to 10 positions (even only) and 16 positions
- Mates with all standard Mini-Universal MATE-N-LOK connector housings and pin headers (except Blindmate)
- Positive, polarized keyed and latched orientation to ease application
- Utilizes proven Mini-Universal MATE-N-LOK contacts with existing application tooling
- Tested to Sealing Level of IP56 and IP57 per IEC 60529
- Primarily used in Appliance, Vending and HVAC applications
- Compact, durable housings
- Pins and sockets can be accommodated in the same housings
- Contacts fully protected in the housings. Both pins and sockets can be used on the power supply wiring
- Fully polarized to provide proper plug-to-cap mating incorporating a positive locking mechanism to help prevent accidental disengagement of mated connectors. Also facilitates panel mounting
- Free hanging or panel mount
- Connectors can be mounted to .031-.079 [0.79-2.00] thick panels
- With seals, contacts accept wire size range 26-18 AWG [.12-.8 mm<sup>2</sup>] with insulation diameter of .040-.083 [1.02-2.11]
- .163 [4.14] centerline spacing
- Not for interrupting current

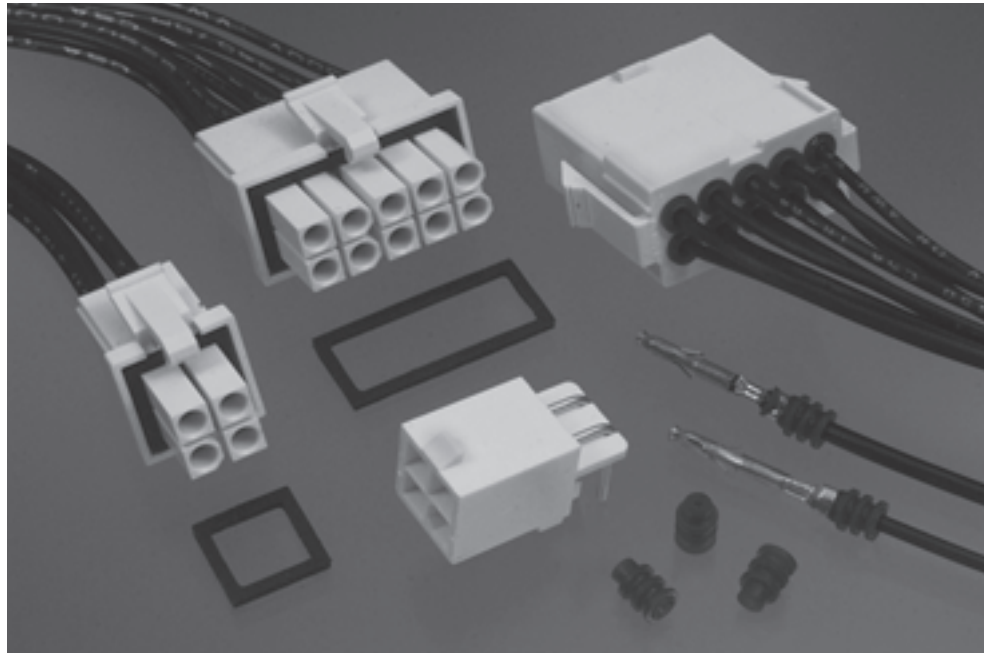

**Performance Characteristics**

The Mini-Universal MATE-N-LOK Connector performance characteristics found on pages 91-92 are based on free hanging and panel mount connectors, loaded with contacts crimped on stranded wire.

**Low Level Termination Resistance**

20 milliohms max. total resistance between wire crimps of a mated pin and socket

**Dielectric Withstanding Voltage—**

1.5 KVAC between adjacent circuits

**Insulation Resistance—**

1000 megohms minimum between adjacent circuits

**Voltage Rating—**600 V AC or DC

**Contact Retention—**8 lb. min. per contact

**Durability—**20 cycles, mating and unmating

**Technical Documents**

**Product Specifications**

- 108-1542-2 Mini-Universal MATE-N-LOK Splash-Proof Seals
- 108-1542 Mini-Universal MATE-N-LOK Connectors
- 108-1543 Mini-Universal MATE-N-LOK Headers

**Application Specification**

- 114-13089 Mini-Universal MATE-N-LOK Sealed Connector

**Instruction Sheets**

- 408-3234 Mini-Universal MATE-N-LOK Connectors
- 411-5105 Mini-Universal MATE-N-LOK Connectors

**Mini-Universal MATE-N-LOK Sealed Connector System (Continued)**

**Contacts**

Pin diameter .039 [0.99]

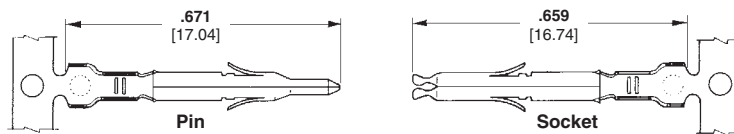

Wire Size Range AWG [mm <sup>2</sup> ]	Ins. Dia. Range	Material and Finish	Contact Part Numbers (for use with Single Wire Seals)				HDM Applicator Part No.	Hand Tool Part No.
			Pin		Socket			
			Strip Form	Loose Piece	Strip Form	Loose Piece		
26-22 [.12-.3]	.040-.060 1.02-1.52	Brass, Pre-tin Brass, Duplex <sup>1</sup>	770901-1	770985-1	770902-1	770986-1	567066-3 <sup>3</sup>	91529-1
			1-770901-0	1-770985-0	1-770902-0	1-770986-0	567066-4 <sup>3</sup>	
							567066-5 <sup>3</sup>	
22-18 [.3-.8]	.050-.083 1.27-2.11	Brass, Pre-tin Brass, Duplex <sup>1</sup>	770903-1	770987-1	770904-1	770988-1	567067-1 <sup>2</sup>	91522-1
			1-770903-0	1-770987-0	1-770904-0	1-770988-0	567067-2 <sup>2</sup>	
							567067-3 <sup>2</sup>	

<sup>1</sup> Duplex Finish—Plated with .000030 [.000762] min. gold in mating area and .000100 [.00254] min. tin in crimping area over .000050 [.00127] min. nickel underplate on entire contact.  
<sup>2</sup> HDM Applicator part number ending in -1 is used on AMPOMATOR CLS Machine with T or G Terminators, -2 is used on AMP-O-LECTRIC Model K Machine, -3 is used on AMP-O-ELECTRIC Model G Machine. See pages 201-204 for further information.  
<sup>3</sup> HDM Applicator part number ending in -3 is used on AMPOMATOR CLS Machine with T or G Terminators, -4 is used on AMP-O-LECTRIC Model K Machine, -5 is used on AMP-O-LECTRIC Model G Machine. See pages 201-204 for further information.

**Plug**

Part Number 794894-1  
(2 position shown)

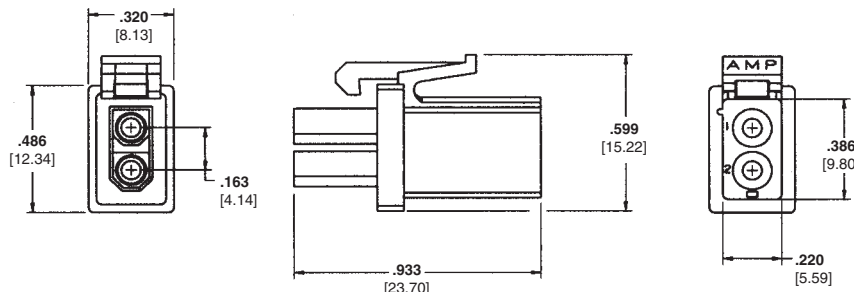

**Cap**

Part Number 794896-1  
(2 position shown)

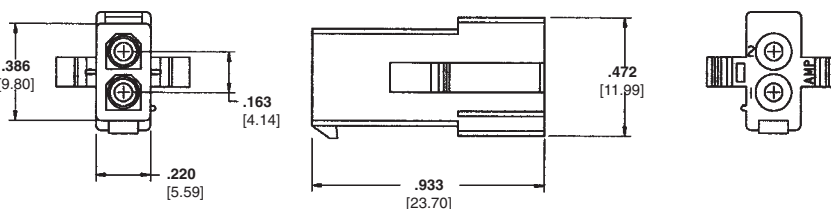

**Single Housing Cavity Plug Seal**

Part Number 794995-1

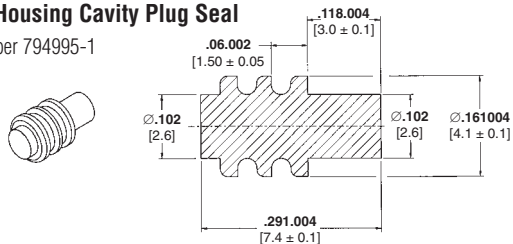

**Single Wire Seal**

Part Number 794758-1

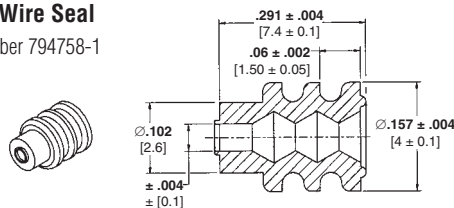

Note: Ganged Wire Seals are available; contact Technical Support.

**Interface Seals**

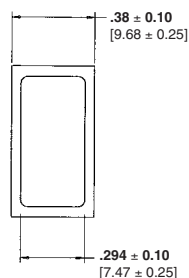

No. of Positions	Part Numbers		
	Plug* for sealing	Cap* for sealing	Interface Seals
2	794894-1	794896-1	794772-2
4	794805-1	794939-1	794772-4
6	794895-1	794940-1	794772-6
8	794821-1	794941-1	794772-8
10	794781-1	794942-1	1-794772-0
16	794824-1	1586404-1	1-1586362-6

\*Nylon, UL 94V-0, white  
 Note: One Interface Seal required per mated assembly.

Note: All part numbers are RoHS Compliant.

**Related Product Data**

Mating Mini-Universal MATE-N-LOK 2 Connectors

Cap Housings — pages 95-96

Vertical Pin Headers — page 97

- Wire-to-wire
- Wire-to-board, right-angle and vertical