



D-2000



D-3000



D-5000

Table of Contents

Product Facts

- Connector system designed for exclusive use with I/O and power circuits in the power and control boards of heavy electric systems and FA equipment, process computers, FA computers, PCs, NCs, servodrivers, servomotors, inverters, switching power supplies, etc.
- Consists of wire-side connector and board-side connector
- Diverse housings are available to meet most specific applications
- With contacts standardized, the tool types used can be reduced
- Termination can be automated and field maintenance simplified
- As contacts can be crimped, connector quality is maintained
- Standardization of contacts leads to easier management of inventory
- To help prevent human errors in termination a common identification mark is on hand tools and contacts
- Housing color and design are coordinated

Note: Connectors are not designed to mate and unmate on energized line.

Introduction and Product Facts 2

D-2000 Series

List of Products by Application (D-2100S, D-2100D and D-2100M) 4

Performance Specifications 5, 6

D-2 Contacts (Strip and Loose Piece) and Application Tooling 7

D-2100S — 1-Row Type

Typical Applications, Mating Combinations and 3-Pos. Housings & Headers 8

Keying 9

Dimensions (Mating and External), 3-Pos. Receptacle & Tab Housings and 3-Pos. Board-mounting Tab Headers (Vertical and Horizontal) 10, 11

D-2100D — 2-Row Type

Typical Applications, Mating Combinations and Housings & Headers 12

Keying 13

Dimensions (Mating and External), Receptacle & Tab Housings and Board-mounting Tab Headers (Vertical and Horizontal) 14, 15

D-2100M

Drawer Type

Typical Applications and 50-Pos. Receptacle & Tab Housings 16

Dimensions (Mating and External), 50-Pos. Receptacle & Tab Housings 17

50-Pos. Board-mounting Tab Header (Horizontal) 18

Panel Mounting Screws (for 50-Pos. Receptacle & Tab Housings) 18

Screw Lock Type

50-Pos. Receptacle and Tab Assemblies (with Screws) 19

D-3000 Series

List of Products by Application

D-3100S, D-3100M and D-3100D 20

D-3200S, D-3200M and D-3200T; D-3400F and D-3500D 21

Performance Specifications 22, 23

D-3 Contacts (Strip and Loose Piece) 24

Application Tooling (Hand Tools and Machines) 24-27

Keying Plug 27

Connector Panel-Mounting Hardware (L Fittings and Push Rivets) 28

D-3100S

Standard 1-Row Type

Typical Applications, Mating Combinations and Ordering Information 29

Keying 30

Dimensions (Mating and External), Receptacle & Tab Housings and Board-mounting Tab Headers (Horizontal and Vertical) 31, 32

Standard SMT Type

Mating Combinations and Ordering Information 33

Dimensions (Mating and External), Receptacle Housings and Board-mounting Tab Headers (Horizontal and Vertical) 33, 34

D-3100D — Standard 2-Row Type

Typical Applications, Mating Combinations and Ordering Information 35

Dimensions (Mating and External), Receptacle & Tab Housings and Board-mounting Tab Headers (Horizontal and Vertical) 36, 37

D-3100M — Modular Type

Typical Applications and 6-Pos. Receptacle Housings & Tab Headers 38

Keying and Mating Combinations 39

Dimensions (Mating and External), 6-Pos. Receptacle Housing and 6-Pos. Board-mounting Tab Headers (Horizontal and Vertical) 40, 41

D-3200S

High Voltage Version of Standard D-3100S

Typical Applications, Mating Combinations and Ordering Information 42

Keying 43

Dimensions (Mating and External), Receptacle & Tab Housings and Board-mounting Tab Headers (Horizontal and Vertical) 44, 45

© 1998, 2002 and 2004 by Tyco Electronics Corporation. All Rights Reserved.

AMP, AMP-O-LECTRIC, AMP-O-MATIC, AMPLIMITE, and TYCO are trademarks.

Table of Contents (Continued)

Need more information?

Call Technical Support at the numbers listed below.

Technical Support is staffed with specialists well versed in Tyco Electronics products. They can provide you with:

- Technical Support
- Catalogs
- Technical Documents
- Product Samples
- Tyco Electronics Authorized Distributor Locations

SMT Type
 Typical Applications and Receptacle Housings & 3-Pos. Tab Header 46
 Dimensions (Mating and External), 3-Pos. Board-mounting Tab Header 47

D-3200M
Modular Type
 Typical Applications and Ordering Information 48
 Keying and Mating Combinations 49
 Dimensions (Mating and External), Receptacle & Tab Housings and Board-mounting Tab Headers (Horizontal and Vertical) 50, 51

Drawer Type
 Typical Applications, Mating Combinations and Ordering Information 52
 Dimensions (Mating and External), 6-Pos. Receptacle & Tab Housings and 6-Pos. Board-mounting Tab Headers (Horizontal and Vertical) 53, 54

D-3200T — 3-Row Type
 Typical Application and 9-Pos. Board-mounting Tab Headers, Dimensions (Mating and External) and Keying 55

D-3400F — Skyscraper Connectors
 Typical Applications, Mating Combinations and Ordering Information 56
 Dimensions (Mating and External), Receptacle Housings and Board-mounting Tab Headers (Horizontal) 57, 58

D-3500D — Sensor Connectors
 Typical Applications, Mating Combinations and Ordering Information 59
 Dimensions (Mating and External), Receptacle & Tab Housings and Board-mounting Tab Headers (Horizontal and Vertical) 60, 61

D-3700 — Connectors for Exclusive Use with Servomotors
 Typical Applications, 6-Pos. Receptacle Connector Kits 62
 Dimensions (Mating and External) and Optional Motor-side Tab Header 63

D-5200 Series
 List of Products by Application (D-5200S and D-5200M) 64
 Performance Data and Specifications 65, 66
 D-5 Contacts (Strip and Loose Piece) and Sequential Clip 67
 Application Tooling (Extraction Tool, Hand Crimping Tool and Machine) 67, 68

D-5200S — Standard 1-Row Type
 Typical Applications, Mating Combinations and Ordering Information 69
 Keying and Servomotor/Servodriver Application 70
 Dimensions (Mating and External), Receptacle & Tab Housings and Board-mounting Tab Headers (Horizontal and Vertical) 71, 72

D-5200M — Modular Type
 Typical Applications and Ordering Information 73
 Keying and Mating Combinations 74
 Dimensions (Mating and External), 4- and 6-Pos. Receptacle & Tab Housings and 4- and 8-Pos. Board-mount Tab Headers (Horizontal) 75, 76

D-5200M — High Current Type
 Typical Applications, Mating Combinations, Ordering Information and Keying 77
 Dimensions (Mating and External), Receptacle Housings and Board-mounting Tab Header (Horizontal) 78, 79

Power Connector — Board-to-Board
 Specifications, Typical Applications and Ordering Information 80
 Dimensions (Mating and External) 81

Part Number Index 82

Global Contacts 83

D-2000 Series

List of Products by Application

D-2000 Series connectors are the smallest in Dynamic Series, yet they can meet requirements of connectors for most industrial applications. They can be used

mainly for signal applications. Signal lines under 250 V are of 2.5 mm pitch, which can accept 18 AWG wires. (5 A max. per position)

D-2000 Series have several unique characteristics such as center-lock method for effective use of PCB properties, contact-entrance method for low profile shapes, and others.

**D-2100S
1-Row Type**

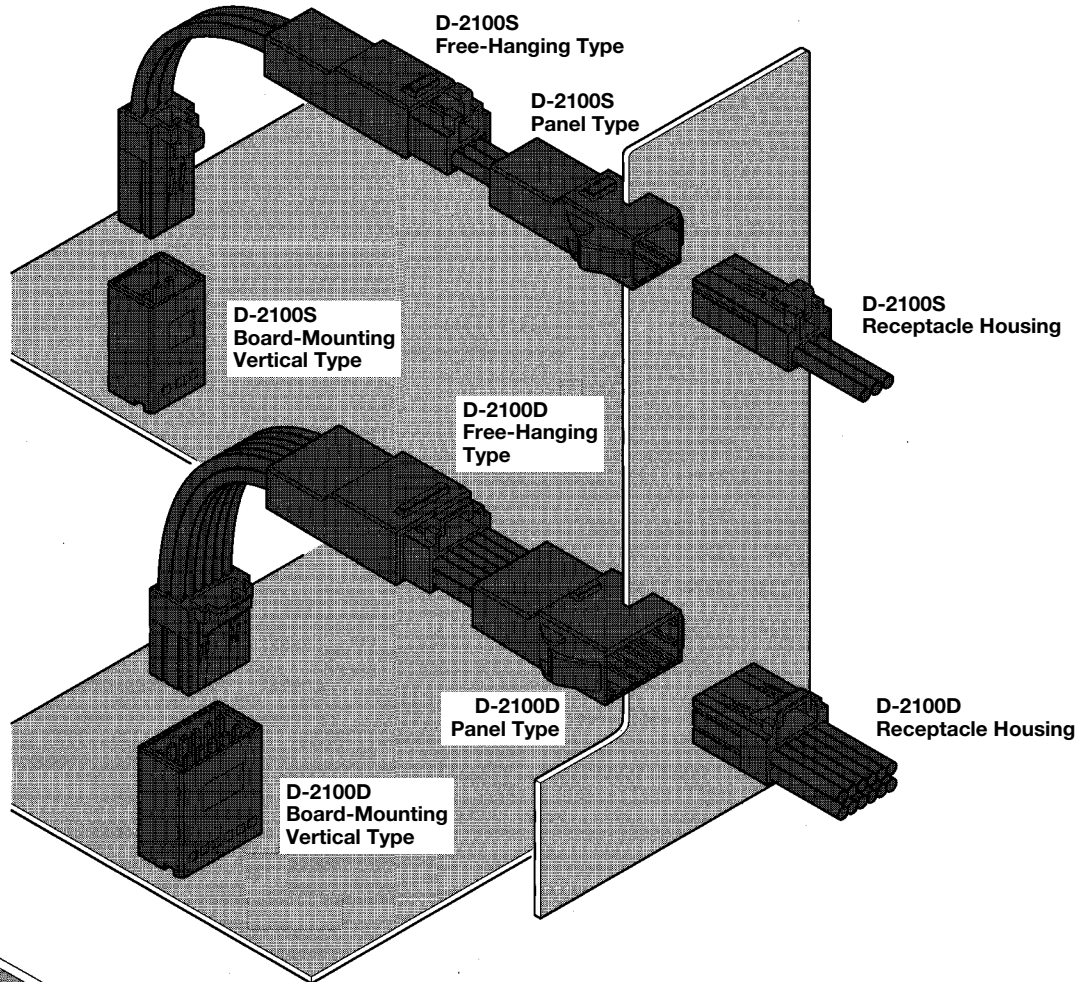

**D-2100D
2-Row Type**

**D-2100M
Drawer Type**

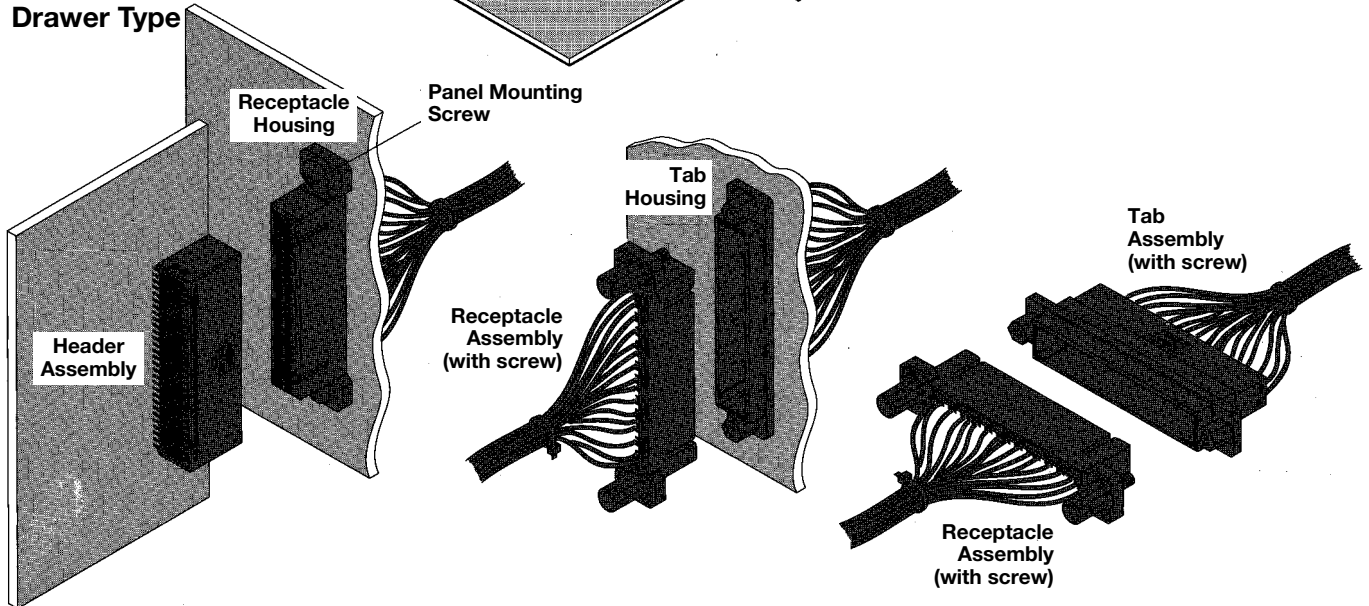

D-2000 Series (Continued)

Performance Specifications

Item	Pitch	2.5mm
Voltage Rating		250V AC/DC
Current Rating		1-position : 5A 3-position : 5A 6-position : 5A 8-position : 4.5A 12-position : 4A 20-position : 3.2A (when using #18 AWG wire)
Insulation Resistance		10m max.
Dielectric Withstanding Voltage		1,500V AC (1minute)
Operating Temperature		-55°~+105°C

*When connectors are used singly.

Material and Finish

Description	Material	Finish
Receptacle contact Tab contact	Copper alloy	Contact area 0.38µm min. gold plating underplated nickel
Tab post	Copper alloy	Contact area 0.38µm min. gold plating — Contact tail tin plated underplated nickel
Housing	UL94V-0 rated glass fiber reinforced polyester (PBT)	

D-2000 Series (Continued)

Performance Specifications

(Continued)

Specifications and Instruction Sheet

Instruction Sheet-Hand Tools

Specifications and Instruction Sheet

Product Specification	108-5619
Testing Report	501-5261
Application Specification	114-5258
Instruction Sheet-Extraction Tool	411-5900

Instruction Sheet-Manual Tool

Tool Part No.	IS No.
91576-1	408-8547
91595-1	408-8547

*Remember to obtain Instruction Sheets when you choose to use these tools.

Safety Specifications

The safety specifications listed below are approved on specific part numbers. Contact our Sales Department to check if the part numbers you use are approved or not. Keep in mind that there are instances where values differ from those given by Tyco Electronics Specifications.

Series	D-2100 Series			D-2100M Drawer Type		
	Voltage Rating	Current Rating	Temperature Rating	Voltage Rating	Current Rating	Temperature Rating
Specifications 108-5619 (Standard) 108-5659 (Drawer Type)	250V AC	5A (1 position)	-55° to +105°C	250V AC	2.6A (with #20 AWG) 50 position	-55° to +105°C
UL File No. E28476	Determined by requirements of equipment in use.	Determined by requirements of equipment in use.	—			
CSA Report No. LR7189	250V AC	#24~28 AWG : 3.3A #18~22 AWG : 5A	—			
TÜV License No. R 9950679	125V AC	5A	-55° to +105°C			

D-2000 Series (Continued)

D-2 Contact and Application Tooling

■ **Crimp Type**

(Gold plating : 0.38µm)

Receptacle Contact

(Used on Receptacle Housing)

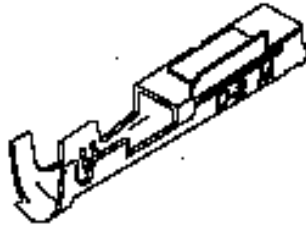

Tab Contact

(Used on Tab Housing)

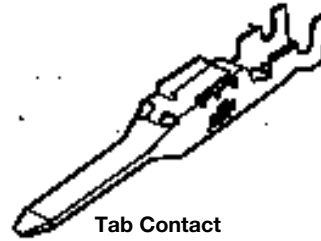

Wire Range		Wire Ins. Diameter	Wire Range Mark	Contact Part Number*		Application Tooling Part Number		
AWG	mm²			Receptacle Contact	Tab Contact	Mini-Applicator	Hand Tool	
28	0.08	0.88~1.5	S	ST.	1318106-1	1318110-1	**	—
26	0.12			LP.	1318108-1	1318112-1	**	91576-1
24	0.20							
22	0.30	1.11~1.87	M	ST.	1318105-1	1318109-1	**	—
20	0.50			LP.	1318107-1	1318111-1	**	91595-1
18	0.85							

* Strip Form contacts are for use with Mini-Applicators (automachines) and Loose-Piece contacts are for Hand Tools.

**Mini-Applicators are for use with automachines. (For part numbers, contact Technical Support.)

Application Tooling

■ **AMP-3K/40 and AMP-5K/40 Terminating Machines**

The AMP-3K/40 and AMP-5K/40 Terminators are designed for customers that require the increased output and quality of a semiauto-matic machine at a competitive price. By incorporating the most commonly requested features as standard and offering a long list of optional equipment, these terminators offer flexibility to meet the specific needs of various applications at the lowest possible cost.

- 3,000 lb. [1361 kg] max. crimp force (AMP-3K/40)
- 5,000 lb. [2268 kg] max. crimp force (AMP-5K/40)
- Toolless removal of applicators and guards
- Jog capability
- Quiet, fast operation — 80/76 dBA and cycle time less than 0.400 seconds
- Accepts Heavy Duty Mini style applicators
- Wide range of optional equipment such as toolless precision crimp height adjust, batch counter, CQM capability and work light
- Order Catalog 1654856 for specifications and part numbers

■ **Hand Tool**

The crimping section incorporates Straight Action construction for improved reliability as with automachine.



Part No. :

See the chart above.

Minimum order quantity : 1



Technical Support

D-2000 Series (Continued)

D-2100S

Appearance Board mounting pitch: 2.5mm
 Dielectric Withstanding Voltage: 1,500V (for one minute)
 Voltage Rating: 250V AC/DC

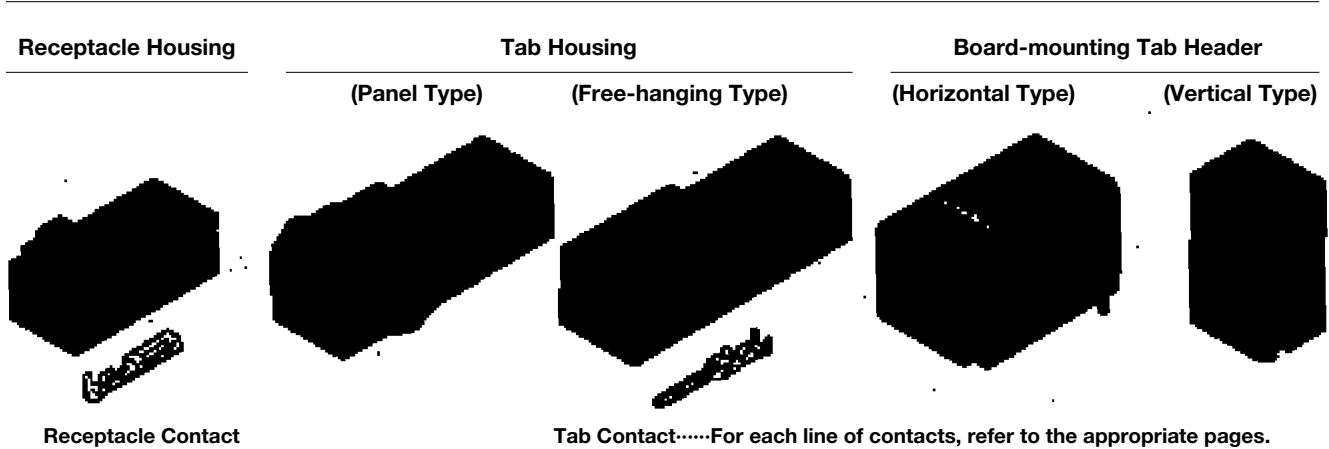
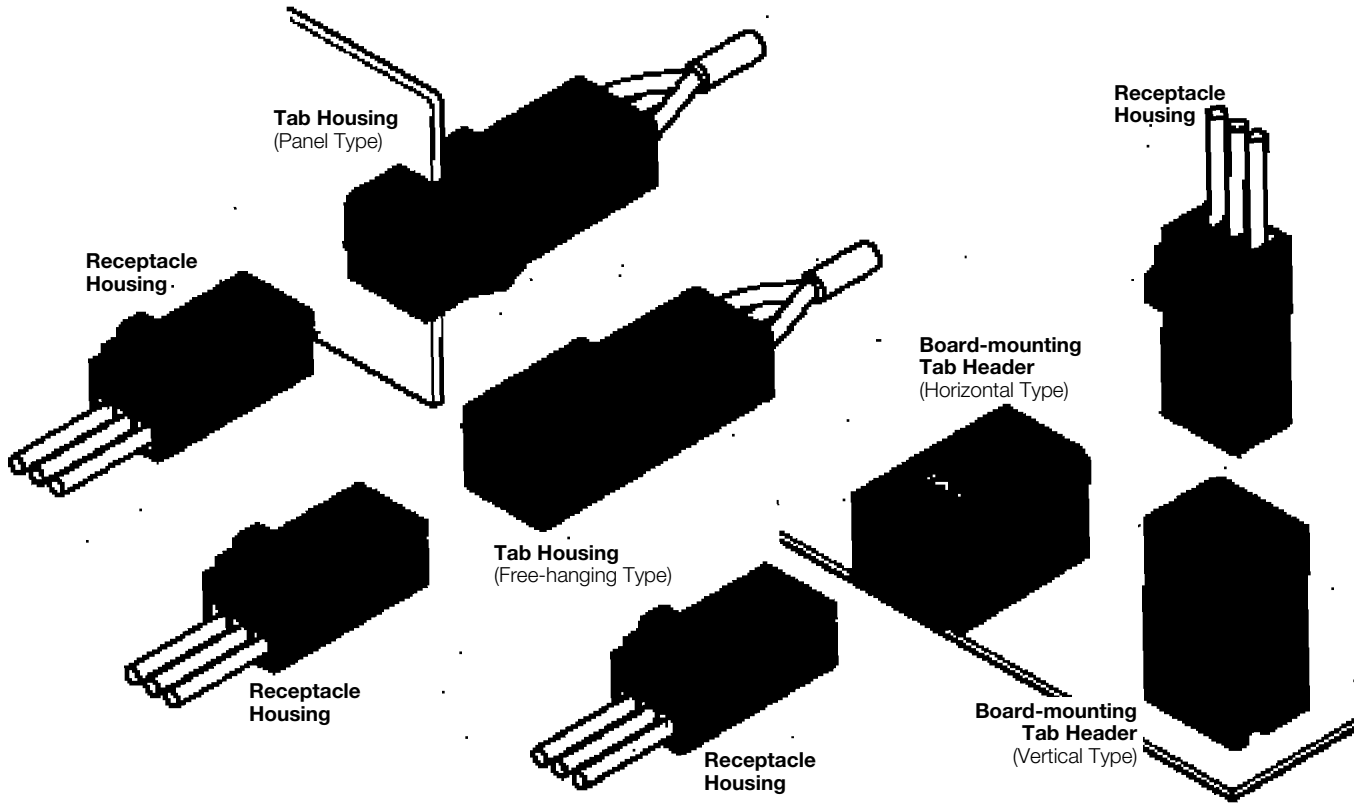

No. of Pos.	Keying	Receptacle Housing	Tab Housing		Board-mounting Tab Header	
			Panel Type	Free-hanging Type	Horizontal Type	Vertical Type
3	X	1-1318120-3	1-1318116-3	1-1318117-3	1376135-1	1318123-1
	Y	2-1318120-3	2-1318116-3	2-1318117-3	1376135-2	1318123-2

D-2000 Series (Continued)**D-2100S** (Continued)**■ Keying**

Keying is provided with this product (D-2100S) for use in helping prevent misinsertion.

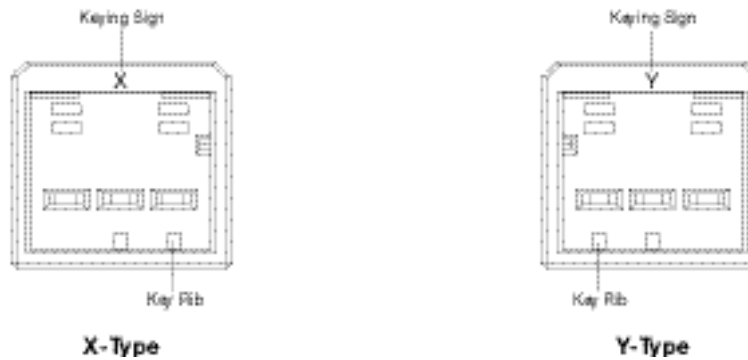

D-2000 Series (Continued)

D-2100S (Continued)

Mating Dimensions

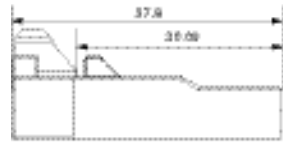

Panel / Free-hanging Type

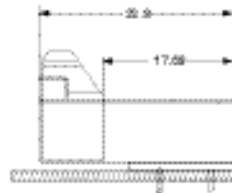

Horizontal Type

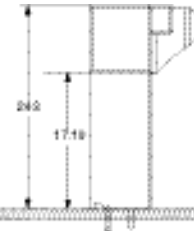

Vertical Type

External Dimensions

■ Receptacle Housing

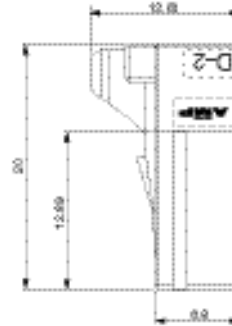
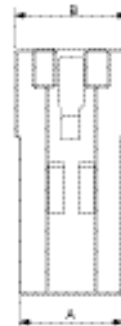
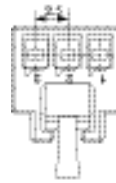
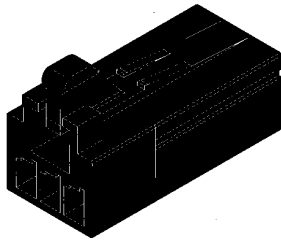

No. of Pos.	Part Number of Receptacle Housing	Dimensions	
		A	B
3	□-1318120-3	8.3	8.9

■ Tab Housing

Panel Type

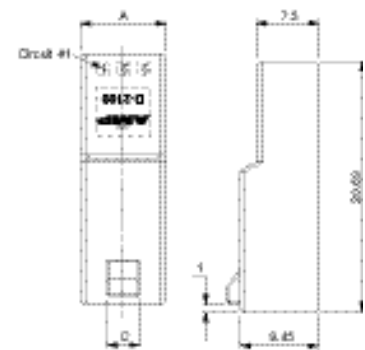
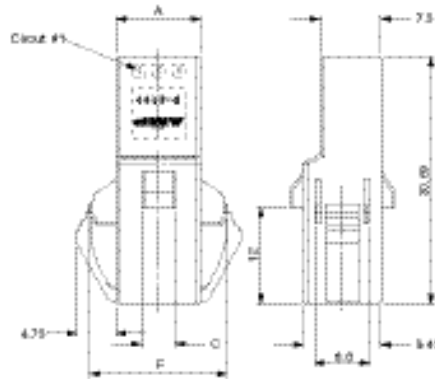
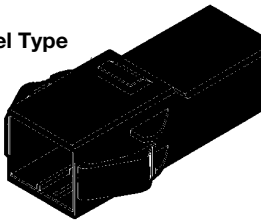

Free-Hanging Type

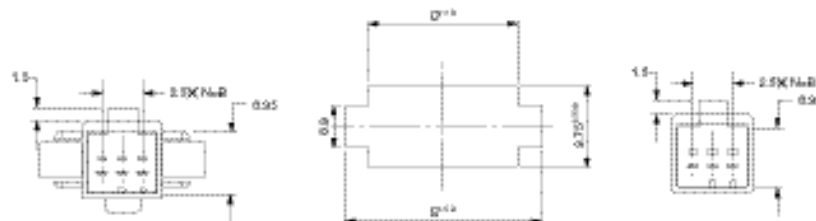
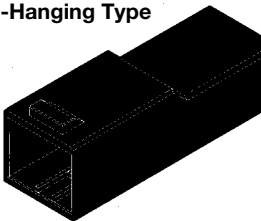

Panel Cutout

No. of Pos.	Part Number of Tab Housing		Dimensions					
	Panel Type	Free-hanging Type	A	B	C	D*	E*	F*
3	□-1318116-3	□-1318117-3	10.2	5	4	10.5	16.5	16.38

*Applies only for panel type. □ is for the following key codes: 1- (X-Type), 2- (Y-Type)

D-2000 Series (Continued)

D-2100S (Continued)

■ **Board-mounting Tab Header (Vertical Type)**

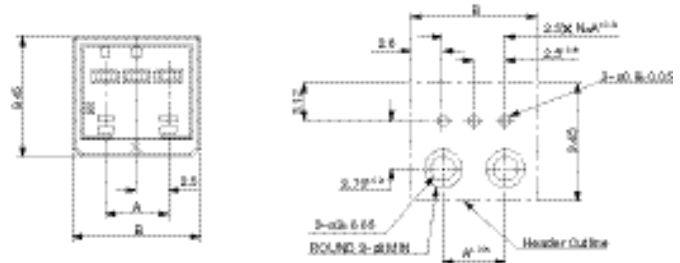

PC Board Layout
Acceptable Board Thickness:
1.6±0.3

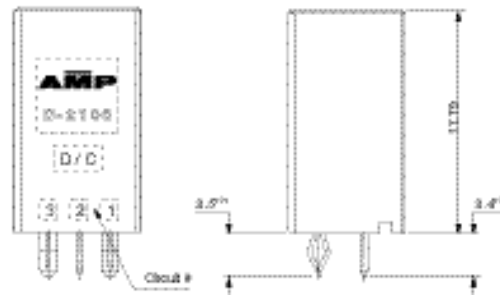

□ is for the following key codes: -1 (X-Type), -2 (Y-Type)

No. of Pos.	Part Number	Dimensions	
		A	B
3	1318123-□	5	10.2

■ **Board-mounting Tab Header (Horizontal Type)**

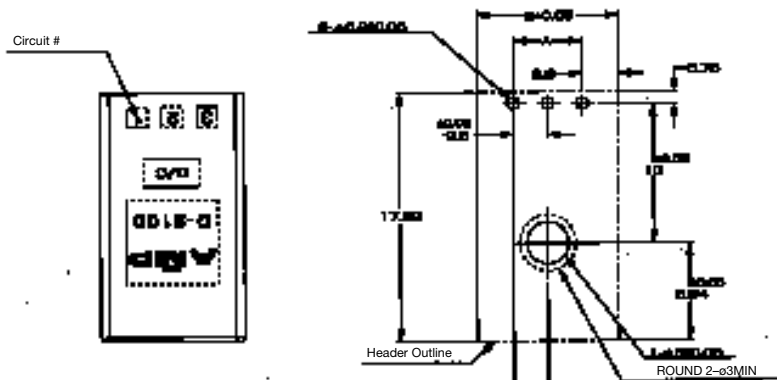

PC Board Layout
Acceptable Board Thickness:
1.6±0.3

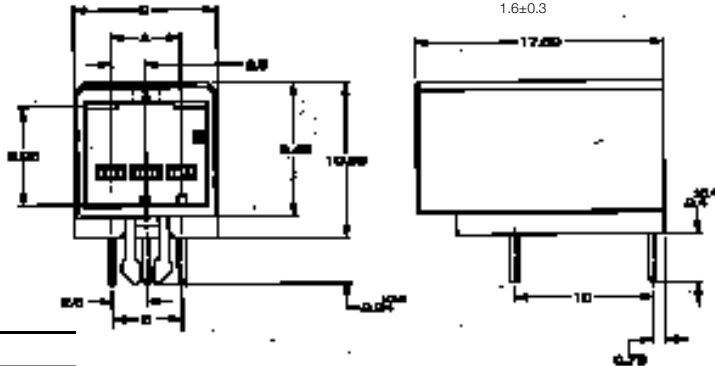

□ is for the following key codes: -1 (X-Type), -2 (Y-Type)

No. of Pos.	Part Number	Dimensions	
		A	B
3	1376135-□	5	10.2

D-2000 Series (Continued)

D-2100D

Appearance Board mounting pitch: 2.5mm
 Dielectric Withstanding Voltage: 1,500V (for one minute)
 Voltage Rating: 250V AC/DC

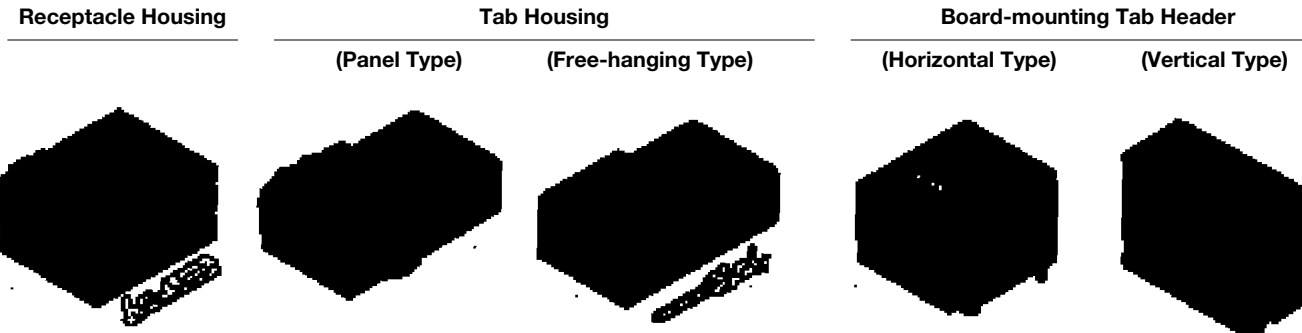
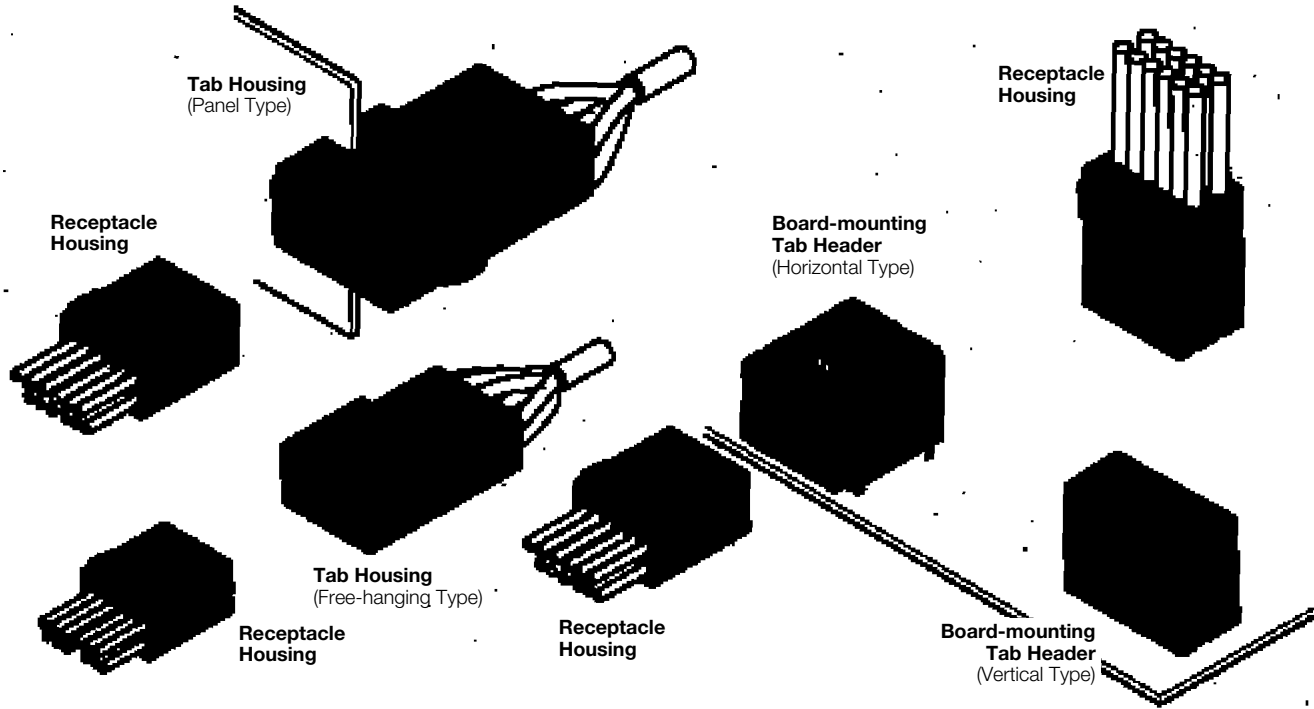

Receptacle Contact

Tab Contact.....For each line of contacts, refer to the appropriate pages.

No. of Pos.	Keying	Part Number of Receptacle Housing	Part Number of Tab Housing		Part Number of Board-mounting Tab Header	
			Panel Type	Free-hanging Type	Horizontal Type	Vertical Type
6	X	1-1318119-3	1-1318114-3	1-1318115-3	1376136-1	1318124-1
	Y	2-1318119-3	2-1318114-3	2-1318115-3	1376136-2	1318124-2
8	X	1-1318119-4	1-1318114-4	1-1318115-4	1376009-1	1318125-1
	Y	2-1318119-4	2-1318114-4	2-1318115-4	1376009-2	1318125-2
12	X	1-1318118-6	1-1318114-6	1-1318115-6	1376020-1	1318126-1
	Y	2-1318118-6	2-1318114-6	2-1318115-6	1376020-2	1318126-2
20	X	1-1318118-9	1-1318114-9	1-1318115-9	1376137-1	1318127-1
	Y	2-1318118-9	2-1318114-9	2-1318115-9	1376137-2	1318127-2

D-2000 Series (Continued)**D-2100D** (Continued)**■ Keying**

Keying is provided with this product (D-2100D) for use in helping prevent misinsertion.

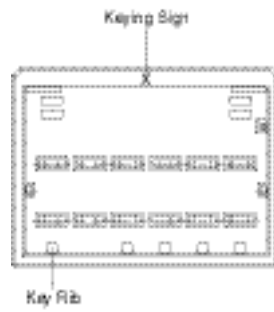
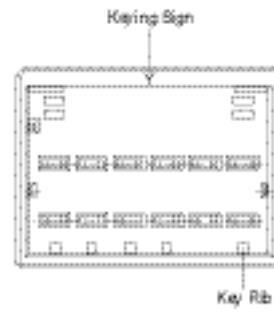
**X-Type****Y-Type**

D-2000 Series (Continued)

D-2100D (Continued)

■ **Board-mounting Tab Header (Vertical Type)**

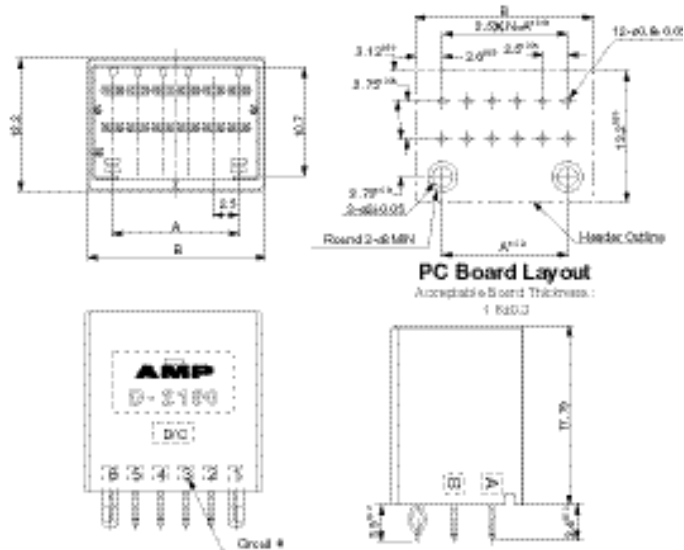

No. of Pos.	Part Number	Dimensions	
		A	B
6	1318124-□	5	10.2
8	1318125-□	7.5	12.7
12	1318126-□	12.5	17.7
20	1318127-□	22.5	27.7

□ is for the following key codes:
-1 (X-type), -2 (Y-Type)

■ **Board-mounting Tab Header (Horizontal Type)**

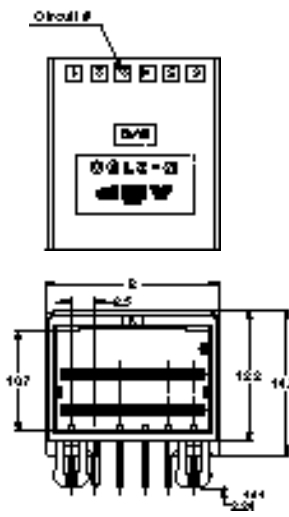

No. of Pos.	Part Number	Dimensions	
		A	B
6	1376136-□	—	10.2
8	1376009-□	7.5	12.7
12	1376020-□	12.5	17.7
20	1376137-□	22.5	27.7

□ is for the following key codes:
-1 (X-type), -2 (Y-Type)

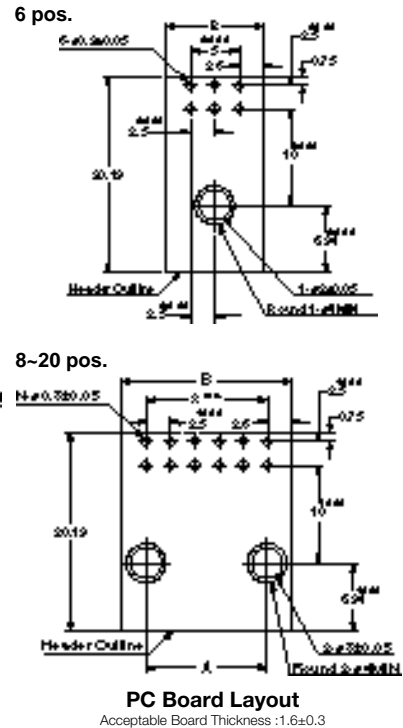

D-2000 Series (Continued)

D-2100M Drawer Type

Appearance

Board mounting pitch : 2.5mm
 Dielectric Withstanding Voltage : 2.3kV (wire-to-wire type), 1.5kV (wire-to-board type)
 Current rating : 2.6A (with 20 AWG, 50 pos.)

■ **Application 1**

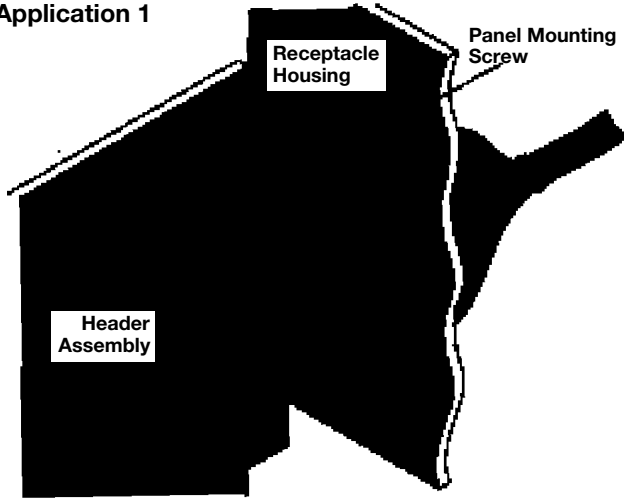

Suitable for an application where the receptacle side is drawer-able and the tab side is fixed.

*The receptacle housing is fixed on the panel with fixed screws.

	Part Number
Receptacle Housing (50 Pos.)	1318577-1
Panel Mounting Screw	900167-1
Header Assembly (50 Pos.)	1318579-1

■ **Application 2**

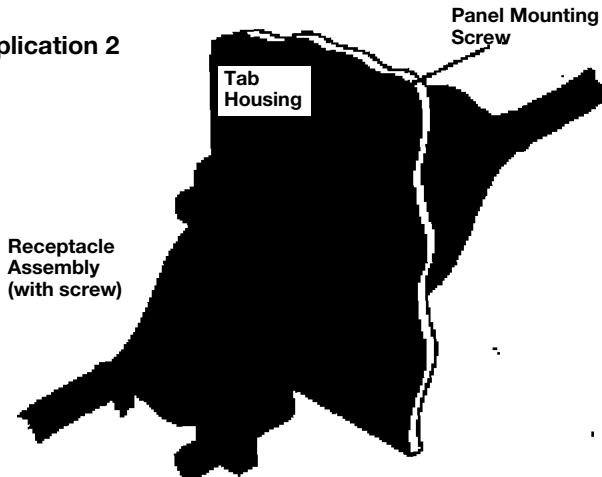

The tab housing is fixed on the panel. The receptacle assembly is mated by turnable jackscrews. Can be used as a wire-to-wire connector with a panel or a bulkhead.

	Part Number
Receptacle Assembly (with screw) (50 Pos.)	1376072-2
Panel Mounting Screw	1376059-1
Tab Housing (50 Pos.)	1318578-2

■ **Application 3**

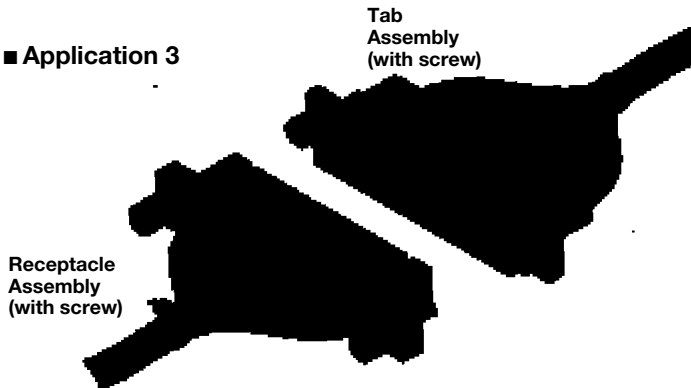

Can be used as a wire-to-wire connector. The tab and receptacle assemblies are mated with two jackscrews on both sides.

	Part Number
Receptacle Assembly (with screw) (50 Pos.)	1376072-2
Tab Assembly (with screw) (50 Pos.)	1376073-2

Product Specification: 108-5659

D-2000 Series (Continued)

D-2100M Drawer Type

(Continued)

Mating Dimensions



Panel/Free-Hanging Type



External Dimensions

■ Receptacle Housing

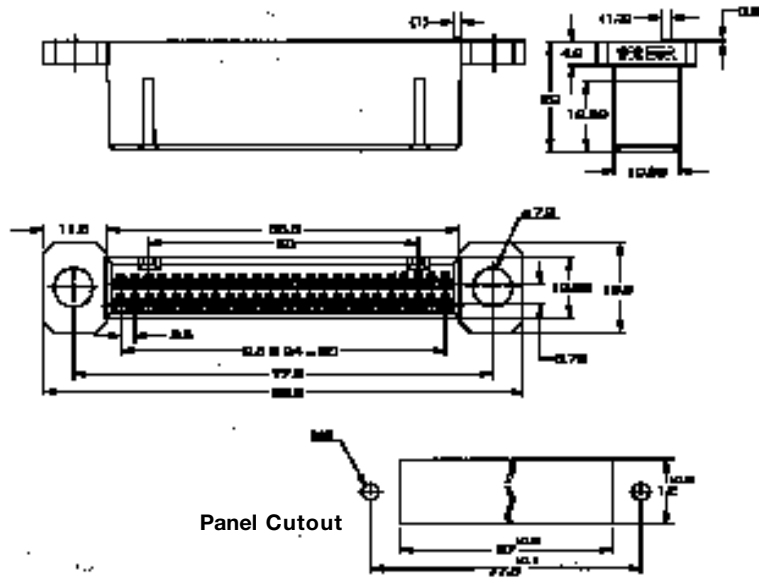

No. of Pos.	Part Number
50	1318577-1

■ Tab Housing

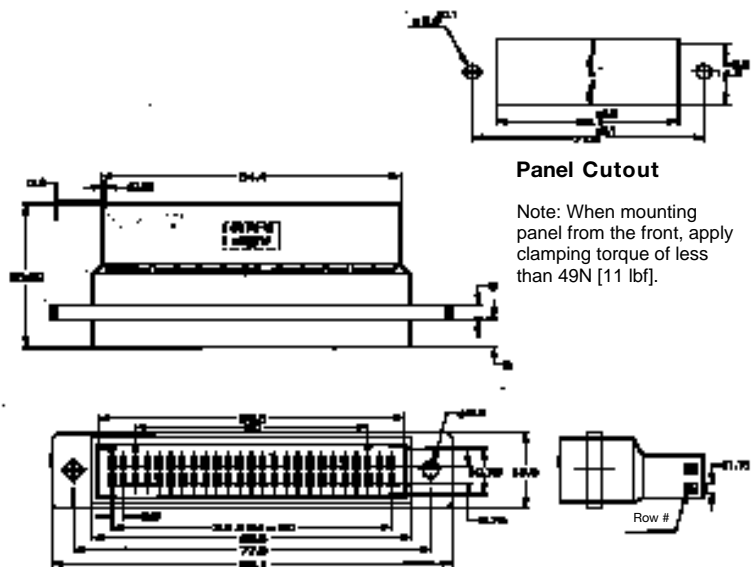

Panel Cutout

Note: When mounting panel from the front, apply clamping torque of less than 49N [11 lbf].

No. of Pos.	Part Number
50	1318578-2

D-2000 Series (Continued)

D-2100M Drawer Type

(Continued)

■ **Board-Mount Tab Header (Horizontal Type)**

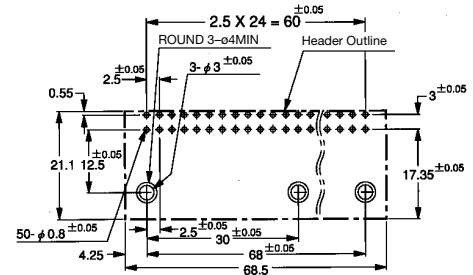
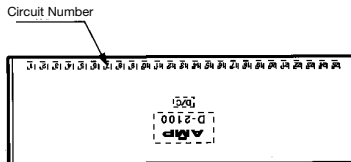
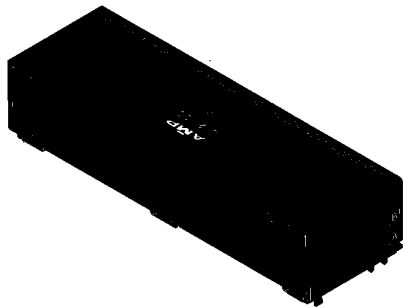

PC Board Layout
Applicable Board Thickness : 1.6±0.4

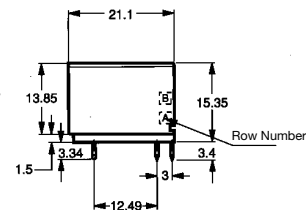
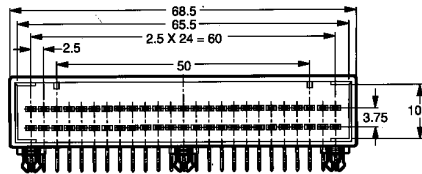

No. of Pos.	Part Number
50	1318579-1

■ **Panel Mounting Screw**

Part Number
900167-1

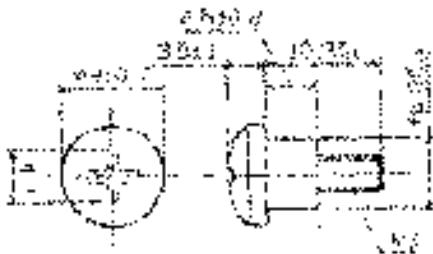

■ **Panel Mounting Screw**

Part Number
1376059-1

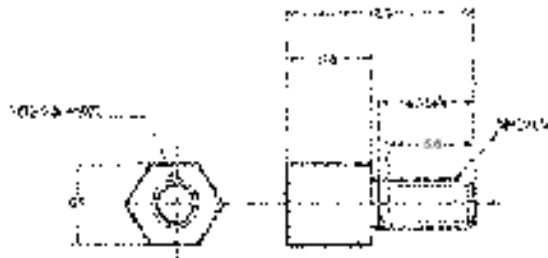

D-2000 Series (Continued)

D-2100M Screw Lock Type

■ **Receptacle Assembly**
(with screw)

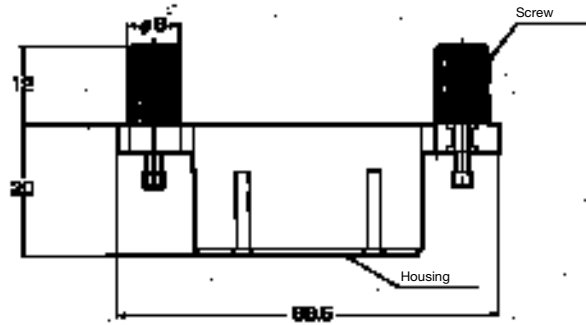

No. of Pos.	Part Number
50	1376072-2

■ **Tab Assembly**
(with screw)

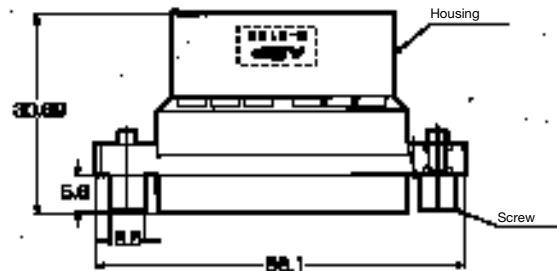

No. of Pos.	Part Number
50	1376073-2

D-3000 Series

**L
A**

Used for both signal circuit and power/power supply circuit applications.

Able to carry 15A max. of current per position and are available in a full range of connector configurations including wire-to-wire, panel-mounting, free hanging, and horizontal and vertical wire-to-board mounting.

D-3100S
Standard 1-Row Type

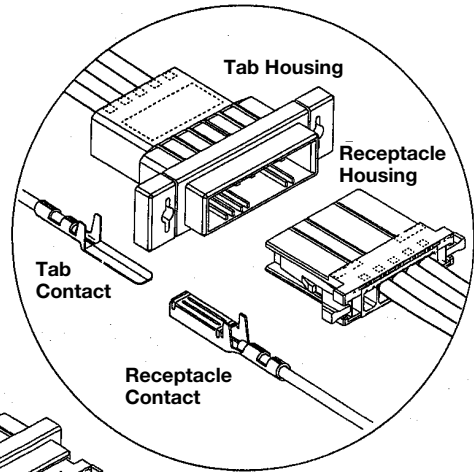

D-3100S Free-Hanging Type

D-3100M
Standard Modular Type

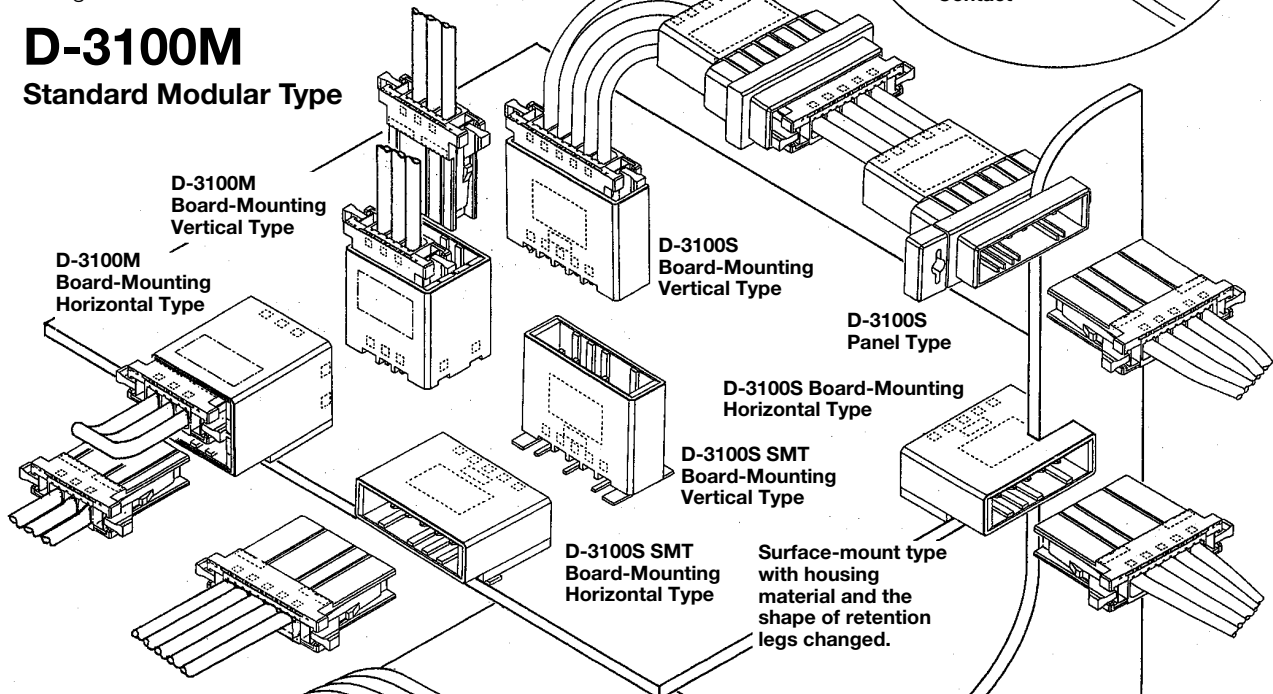

D-3100M Board-Mounting Vertical Type

D-3100M Board-Mounting Horizontal Type

D-3100S Board-Mounting Vertical Type

D-3100S Panel Type

D-3100S Board-Mounting Horizontal Type

D-3100S SMT Board-Mounting Vertical Type

D-3100S SMT Board-Mounting Horizontal Type

Surface-mount type with housing material and the shape of retention legs changed.

D-3100D Board-Mounting Vertical Type

D-3100D Free-Hanging Type

D-3100D Panel Type

D-3100D Board-Mounting Horizontal Type

All connector configurations available as with the standard one-row type line.

D-3100D
Standard 2-Row Type

D-3000 Series (Continued)

List of Products by Application (Continued)

D-3200M

High Pressure Modular Type

Fit for high-voltage circuits.

D-3200S

High Pressure 1-Row Type

Can be used in rack-and-panel application.

D-3200S Drawer Type

D-3200T

High Pressure 3-Row Type

D-3200M Board-Mounting Vertical Type

D-3200M Board-Mounting Horizontal Type

D-3200S Board-Mounting Vertical Type

D-3200S Board-Mounting Horizontal Type

Used for top and bottom (horizontal) modular connections.

D-3500D

D-3400F

Many I/O circuits can be drawn from one header (board side), making it possible to save board-mount space.

Many I/O circuits can be drawn from the board end.

D-3500D

Sensor Connector

D-3400F

Skyscraper Connector

D-3000 Series (Continued)

Performance Specifications

Item	Pitch	150mil (3.81mm)	200mil (5.08mm)
	Voltage Rating		250V AC
Current Rating		1-position : 15A 3-position : 12A 6-position : 10A 16-position : 8A (when using #16 AWG wire)	
Insulation Resistance		10m max.	
Dielectric Withstanding Voltage		1,500V AC	2,200V AC (1 minute)
Operating Temperature		-55°~+105°C	

*When connectors are used singly.

Generally, the current value of connector is shown as per position. The current rating of this product is 15A as shown in the table. Note that in all circumstances it is the value per position. As the number of positions increases, this value decreases. This decrease can be calculated from the table and the current curve shown in the graph below.

Example:

- With a 6-position connector, 10A of current per position or a total of 60A (max) can be carried as shown in the table.
- With a 10-position connector, 8.5A of current per position or a total of 85A (max) can be carried as indicated by dotted lines in the graph below.

Number of Positions vs Current Curve (reference)

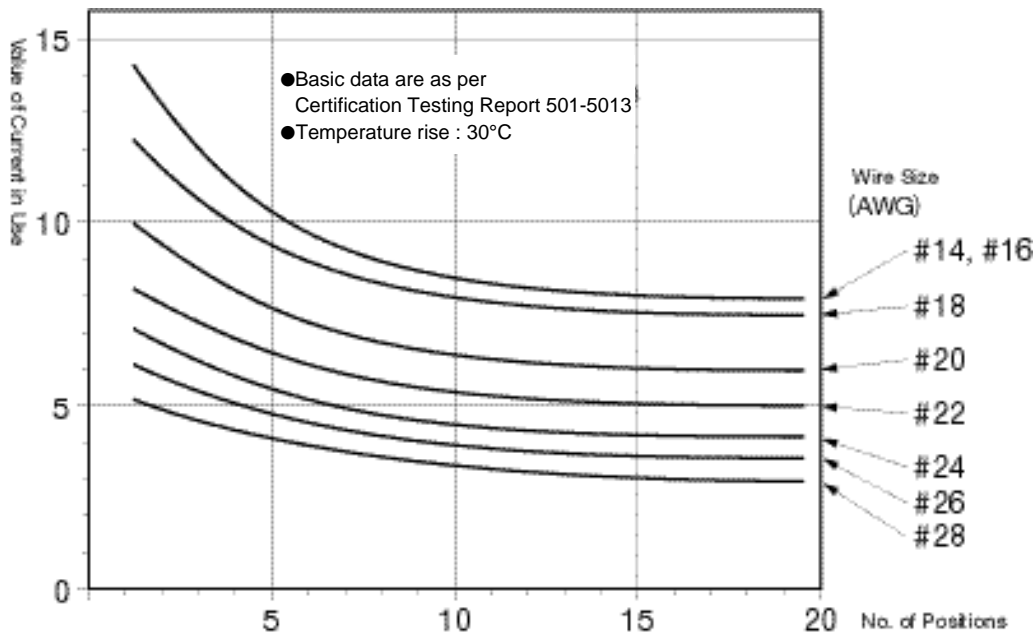

Material and Finish

Description	Material	Finish
Receptacle contact Tab contact	Copper alloy	Bright tin plating and gold plating with underplated nickel (1.27µm)
Tab post	Copper alloy	Tin plating and gold plating with underplated nickel (1.27µm)
Housing	UL94V-0 rated glass fiber reinforced polyester (PBT) 66 Nylon and PPS (SMT Type), black color.	

D-3000 Series (Continued)

Performance Specifications

(Continued)

Specifications and Instruction Sheets

Specifications and Instruction Sheets

Product Specification	108-5349
Testing Report	501-5013
Application Specification	114-5148
Instruction Sheet-Extraction Tool	411-5726

Instruction Sheet-Hand Tools

Instruction Sheet-Manual Tools

Tool No.	IS No.
919600-1	
919601-1	411-5626
919602-1	
234172-1	411-5714

*Remember to obtain Instruction Sheets when you choose to use these tools.

Safety Specifications

The safety specifications listed below are approved on specific part numbers. Contact our Technical Support to check if the part numbers you use are approved or not. Keep in mind that there are instances where values differ from those given by Tyco Electronics Specifications.

Series	D-3100, D-3400 Series (3.81mm pitch)			D-3200, D-3500 Series (5.08mm pitch)		
	Voltage Rating	Current Rating	Temperature Rating	Voltage Rating	Current Rating	Temperature Rating
Specifications 108-5349	250V AC	See page 22	-55° to +105°C	600V AC (Single conn.)	See page 22	-55° to +105°C
UL File No. E28476 (Recognized Component)	Determined by requirements of equipment in use.	Determined by requirements of equipment in use.	—	Determined by requirements of equipment in use.	Determined by requirements of equipment in use.	—
CSA Report No. LR7189	250V AC	8A max.	—	250V AC	8A max.	—
TÜV License No. R9151488 (VDE0627) IP Protection IP-00 Overvoltage Classification(II) Number of Repeated Insertions and Withdrawals 50	250V AC	#28 AWG=2A #26 AWG=3A #24 AWG=3A #22 AWG=4A #20 AWG=5A #18 AWG=6A #16 AWG=8A #14 AWG=8A	-20° to +105°C	500V AC	#28 AWG=2A #26 AWG=3A #24 AWG=3A #22 AWG=4A #20 AWG=5A #18 AWG=6A #16 AWG=8A #14 AWG=8A	-20° to +105°C

D-3000 Series (Continued)

D-3 Contact and Application Tooling

■ **Crimp Type**

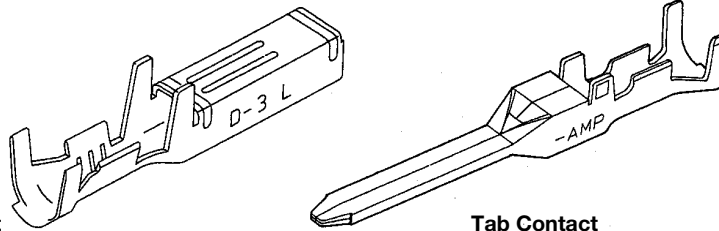

Receptacle Contact
(Used on Receptacle Housing)

Tab Contact
(Used on Tab Housing)

Wire Range		Wire Ins.	Wire Range Mark	Contact Part Number*			Application Tooling Part Number		
AWG	mm ²	Diameter		Receptacle Contact		Tab Contact	Mini-Applicator	Hand Tool	
				Standard contact (Only -2 & -3 available)	High contact (pressure -2, -3, & -5 available)				Standard Type
28	0.08	0.8~1.2	S	ST.	175194-□	1-175194-□	175284-□	**	—
26	0.12			LP.	175216-□	1-175216-□	175287-□	**	91565-1
24	0.20			1.0~1.4					
24	0.20	1.2~1.6	M	ST.	175195-□	1-175195-□	175285-□	**	—
22	0.30	1.7~2.6		LP.	175217-□	1-175217-□	175288-□	**	91559-1
20	0.50								
20	0.50	1.8~2.8	L	ST.	175196-□	1-175196-□	175286-□	**	—
18	0.85			LP.	175218-□	1-175218-□	175289-□	**	91558-1
16	1.25	2.2~2.8	2L	ST.	917484-□	1-917484-□	917485-□	**	—
14	2.20			LP.	917511-□	1-917511-□	917512-□	**	91560-1
16	1.25	3.1~3.3	3L	ST.	353715-□	1-353715-□	353716-□	**	—
14	2.20			3.3~3.4	LP.	353717-□	1-353717-□	353718-□	**

Note : *Enter the following plating code in Part Number suffix-□ :
 -2 = 0.38µm thick gold plating
 -3 = 0.76µm thick gold plating
 -5 = Tin plating

* Solder-type Contact: We do not manufacture solder-type contacts for this specific application.

* Strip Form contacts are for use with Mini-Applicators (automachines) and Loose-Piece contacts are for Hand Tools.

** Mini-Applicators are for use with automachines. (See page 26. For Part Numbers, contact Technical Support.)

■ **Hand Tools**



Standard Type

Uses	For General Production
Can it be used for repairing?	Yes
Approximately how many cycles of crimping can be performed?	More than 50,000
What is Minimum Order Quantity?	1

D-3000 Series (Continued)

Application Tooling

(Continued)

■ **Hand Tool**

This hand tool is designed to be capable of handling most Factory Automation (FA) related crimping operations by a single tool in order to simplify harness fabrications suited to the specific needs of FA market. The equipment forming the nucleus of the FA system includes PCs, CNCs, servodrivers and servomotors. And the wire used in connecting this equipment ranges in wire size from #26-20 AWG which applies to signal circuits to #18-16 AWG which is for power circuits (See Sketch below).

Crimping Range A, B, and C are for explanation purposes only and are not marked on the tool body.

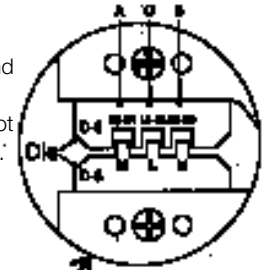

For right-handed use
Hand Tool P/N : 58571-1
Die Set P/N : 58571-2

The frame of right-handed tool has the same configuration as that of Economy Type (II) and PRO-CRIMPER II Hand Tool (See PRO-CRIMPER Hand Tool Catalog). So die sets are interchangeable.



Servomotor / Servodriver Typical Application

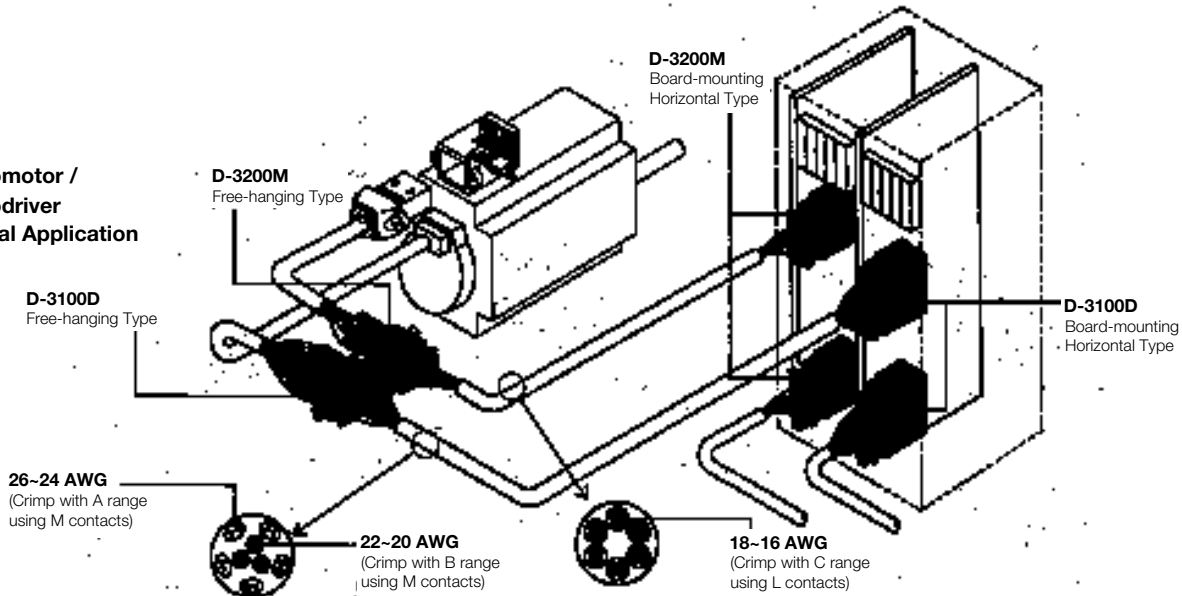

D-3000 Series (Continued)

Application Tooling (Continued)

■ **AMP-3K/40 and AMP-5K/40 Terminating Machines**



Mini-Applicator
Minimum Quantity : 1



Contact Technical Support for
Mini-Applicator Part Number

The AMP-3K/40 and AMP-5K/40 Terminators are designed for customers that require the increased output and quality of a semi-automatic machine at a competitive price. By incorporating the most commonly requested features as standard and offering a long list of optional equipment, these terminators offer flexibility to meet the specific needs of various applications at the lowest possible cost.

- 3,000 lb. [1361 kg] max. crimp force (AMP-3K/40)
- 5,000 lb. [2268 kg] max. crimp force (AMP-5K/40)
- Toolless removal of applicators and guards
- Jog capability
- Quiet, fast operation — 80/76 dBA and cycle time less than 0.400 seconds
- Accepts Heavy Duty Mini style applicators
- Wide range of optional equipment such as toolless precision crimp height adjust, batch counter, CQM capability and work light
- Order Catalog 1654856 for specifications and part numbers

■ **AMP-O-LECTRIC Model G Terminating Machine**

The Model "G" Terminator is the most advanced design in the long-standing series of AMP-O-LECTRIC machines for terminating wire using reeled terminals and contacts. It features a reliable direct motor drive system. Its modular construction enables it to be used either as a bench-top unit, or in combination with fully-automatic lead-making equipment. For operator convenience, access to and lighting in the target area has been improved and the Crimp Quality Monitor (CQM) has been moved to eye level for bench-top use. The Model "G" is also quieter, plus improved guarding meets applicable European and domestic safety requirements.

- Quieter
- Improved guarding and lighting
- Toolless changeover of applicators
- Precision manual- or auto-adjust for crimp height
- Total and batch counter
- Accepts all existing Tyco Electronics miniature applicators, with minor modifications
- Reduced maintenance requirements
- Request Catalog 65828 for specifications and part numbers



■ **AMP-O-MATIC Side-Feed Stripper/Crimper Machine**

This semiautomatic bench machine strips and terminates wire in a single operation. You simply position the wire against a spot illuminated on the wire stop and cycle the machine. In the automatic mode, the machine cycles when the wire touches the wire stop.

Using interchangeable applicators, this versatile machine is ideal for terminating jacketed cable with a variety of pin and socket contacts. Applicators are also available for non-AMP products.

- Strip and terminate wires 32-14 AWG [0.03-2mm²]
- Fast set-up times: 10 minutes or less
- Illuminated target area
- Convenient scrap removal
- Select foot switch or wire-sensor mode of operation
- Request Catalog 65004 for specifications and part numbers



D-3000 Series (Continued)

Application Tooling

(Continued)

■ Extraction Tool

This tool is used to extract contacts from wire-type tab/receptacle housings.



Part Number: 234168-1

*Take care not to insert into the Contact Section.

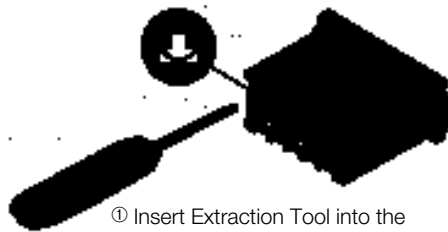

① Insert Extraction Tool into the narrow section of the upper convex cavity of housing in the direction as shown (Make sure the Tool's top and bottom are in correct position.)



② The Extraction Tool tip lifts up housing lance, making contact free.



③ Contact can now be pulled out.

■ Keying Plug

(used to help prevent misinsertion)

Keying plug is used to minimize the possibility of contacts being inserted in wrong directions when using connectors of the same size end-to-end.

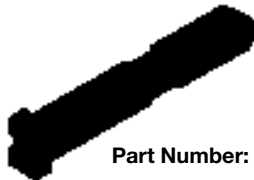

Part Number: 175855-1

■ Tab Contact Cutting Tool



Part Number: 919041-1

How To Use Plug and Tool

*Some of the products in this Series (D-3100S/D-3100M/D-3200S/D-3200M) are preloaded with keying plugs to help prevent misinsertion.

① Insert a keying plug in one position of receptacle Housing.

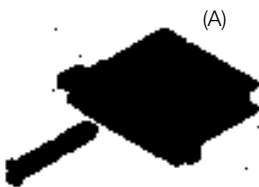

② Twist off a tab in the corresponding position of mating Tab Header and empty that position. To twist off the tab, insert Cutting Tool into its root and turn Tool as shown.

* For Tab housing (Panel/Free hanging Types), leave Housing empty by not inserting a contact in one position.

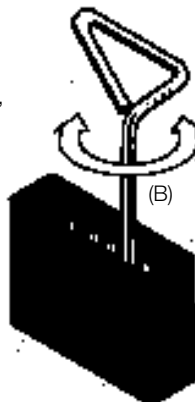

③ This being done, contacts cannot be inserted in wrong direction.

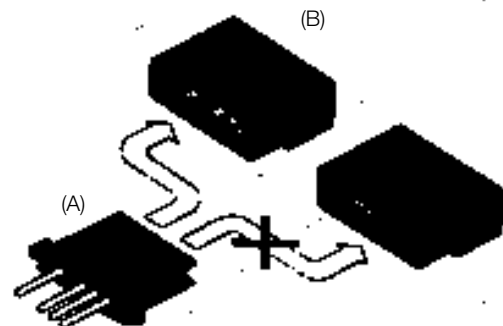

D-3000 Series (Continued)

Connector Mounting Hardware

■ **L Fittings**

Used to secure free-hanging type tab housings onto panels. Applicable housings are specified in the table of housings.

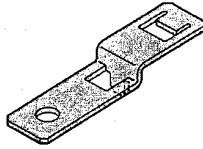

Part Number: 900121-2 (S)

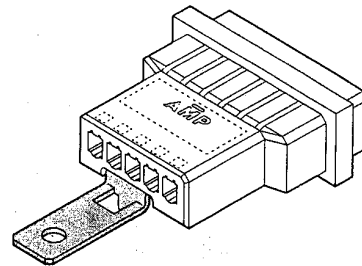

■ **External Dimensions**

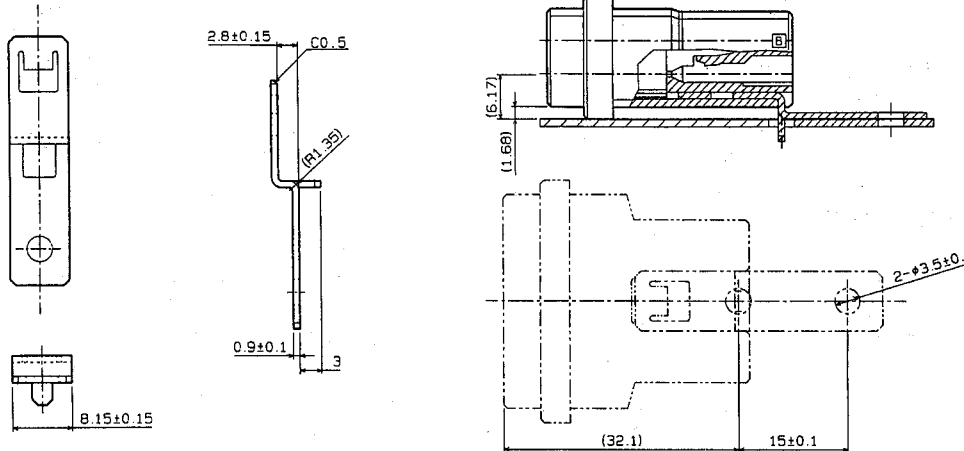

Part Number: 900121-2 (S)

The location where housing is attached varies by Series and size. Check with sample.

■ **Push Rivets**

Used to secure panel-type tab housings onto panels (Use as handy mounting hardware. Cannot be used with larger sized housings or those that are frequently inserted and withdrawn).

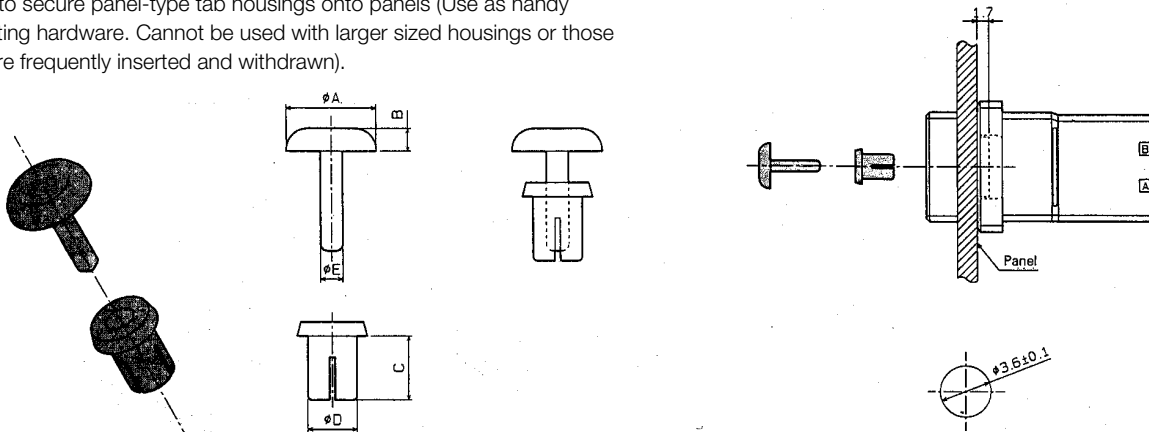

Recommended panel hole dimension

Part Number	Panel Thickness	Dimensions					Insertion Force	Retention Force
		A	B	C	D	E		
900128-1	0.3-1.3	6.4	1.6	4.5	3.5	1.95	2-3kg	13kg Min.*
900128-2	1.3-2.3	6.4	1.6	5.5	3.5	1.95	2-3kg	13kg Min.*
900128-3	2.8-3.8	6.4	1.6	7.0	3.5	1.95	2-3kg	13kg Min.*

*When 2 push rivets are used.

D-3000 Series (Continued)

**D-3100S — Standard
1-Row Type**

Appearance Board mounting pitch: Horizontal Type 150 mils (3.81mm) / Vertical Type 150 mils (3.81mm)
Dielectric Withstanding Voltage: 1,500V (for one minute)
Voltage Rating: 250V AC

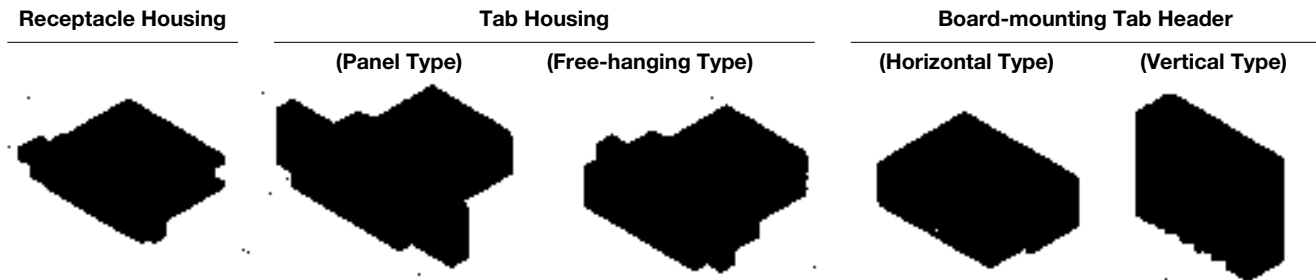
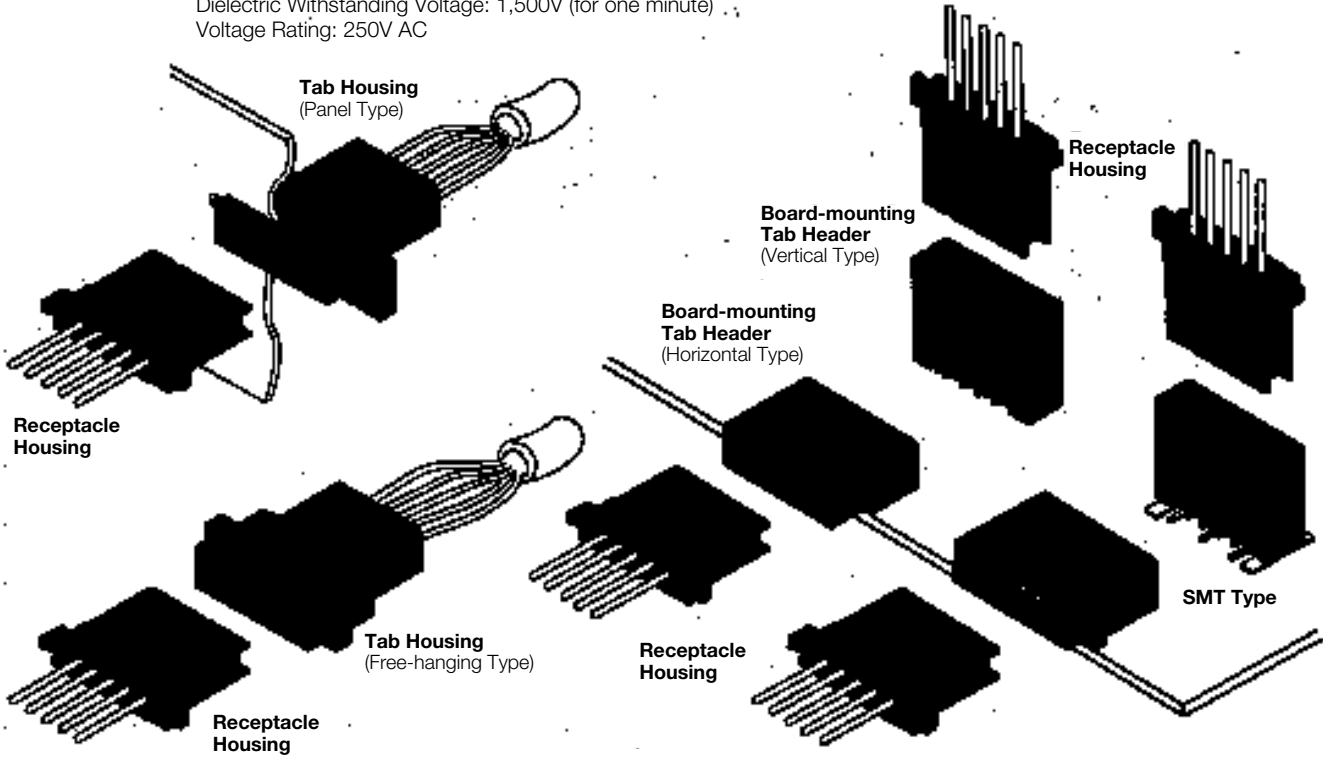

No. of Pos.	Keying	Receptacle Housing	Tab Housing			Board-mounting Tab Header	
			Panel Type	Free-hanging Type	L Fitting	Horizontal Type	Vertical Type
2	See D-3200S Series						
3	X	1-178288-3 ^{*1}	1-178802-3	1-177648-3	S	1-178293-□	1-178313-□
	Y	2-178288-3 ^{*2}	2-178802-3	2-177648-3	S	2-178293-□	2-178313-□
4	X	1-178288-4	—	—	S	1-178294-□	1-178314-□
	Y	2-178288-4	—	—	S	2-178294-□	2-178314-□
5	X	1-178288-5 ^{*3}	1-178802-5	1-177648-5	—	1-178295-□	1-178315-□
6	X	1-178288-6	—	—	—	1-178296-□	1-178316-□
	Y	2-178288-6	—	—	—	2-178296-□	2-178316-□
8	X	1-178288-7 ^{*4}	1-178802-7	1-177648-7	—	1-178297-□	1-178317-□
10	X	1-178288-8	1-178802-8	1-177648-8	—	1-178298-□	1-178318-□
	Y	2-178288-8	2-178802-8	2-177648-8	—	2-178298-□	2-178318-□

Note: Enter the following plating codes in -□ after Part Numbers:
-2 = 0.38µm thick gold plating, -3 = 0.76µm thick gold plating,
-5 = Tin plating

*1, *3 and *4 can be used as SMT Type Receptacle Housing.
*1 and *2 can also be used in modular configuration in combination with D-3100M Tab Header.

D-3000 Series (Continued)**D-3100S — Standard
1-Row Type** (Continued)**■ Keying**

This product (D-3100S) is provided with keying plugs to help prevent misinsertion of contacts. Two types are available; X Type and Y Type (Shown below is the mating front of Tab Header).

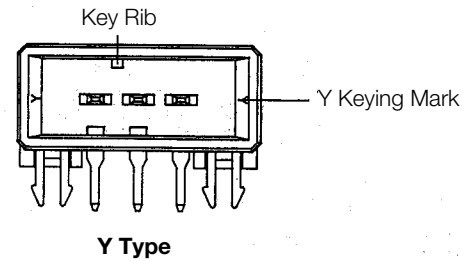
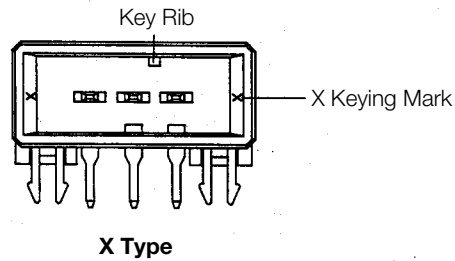

D-3000 Series (Continued)

D-3100S — Standard
1-Row Type (Continued)

■ **Mating Dimensions**

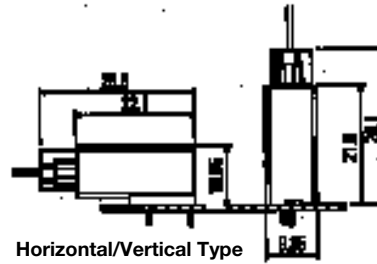

■ **Receptacle Housing**



No. of Pos.	Part Number	Dimensions	
		A	B
2	—	—	—
3	□-178288-3	26.76	16.7
4	□-178288-4	30.57	20.51
5	□-178288-5	34.38	24.32
6	□-178288-6	38.19	28.13
8	□-178288-7	45.81	35.97
10	□-178288-8	53.43	43.37

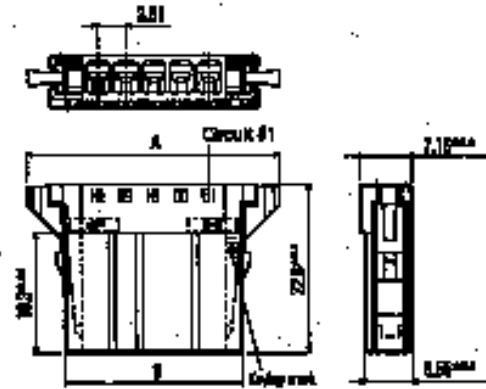

■ **Tab Housing**

Panel Type

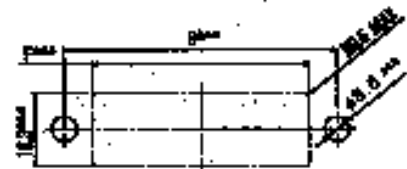
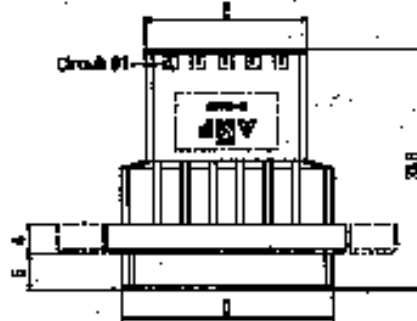

Panel Cutout

When mounting panel from the front, apply clamping torque of less than 49N [11 lbf].

Free-hanging Type

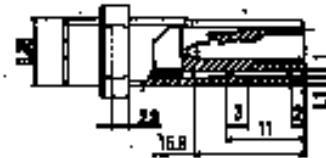
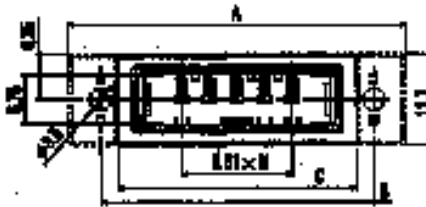

No. of Pos.	Part Number		Dimensions					
	Panel Type	Free-hanging Type	A	B	C*	D	E	F
2	—	—	—	—	—	—	—	—
3	□-178802-3	□-177648-3	40	31	25.57	21.62	14.62	22.6
4	—	—	—	—	—	—	—	—
5	□-178802-5	□-177648-5	47	38	33.19	29.24	22.24	30.2
6	—	—	—	—	—	—	—	—
8	□-178802-7	□-177648-7	59	50	44.62	40.67	33.67	41.6
10	□-178802-8	□-177648-8	67	58	52.24	48.29	41.29	49.2

*Applicable to Free-hanging Type only.

D-3000 Series (Continued)

D-3100S — Standard SMT Type

Appearance Withstanding Voltage: 1,500V (for one minute) Voltage Rating: 250V AC

Receptacle Housing



Board-mounting Tab Header

(Horizontal Type)



(Vertical Type)



Part Number Chart

No. of Pos.	Keying	Receptacle Housing*	Board-mounting Tab Header	
			Horizontal Type	Vertical Type
3	x	1-178288-3	—	—
5	x	1-178288-5	1-177662-□	1-177665-□
8	x	1-178288-7	1-179188-□	—

Note: Enter the following plating codes in -□ after Part Numbers:
 -2 = 0.38µm thick gold plating
 -3 = 0.76µm thick gold plating

Material of Tab Header : P.P.S.
 *D-3100S Series.

Mating Dimensions

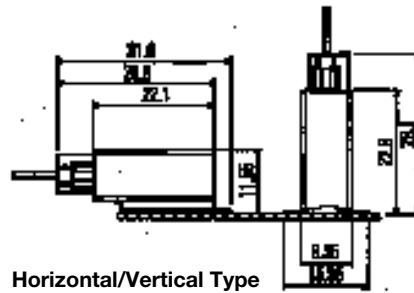

Receptacle Housing

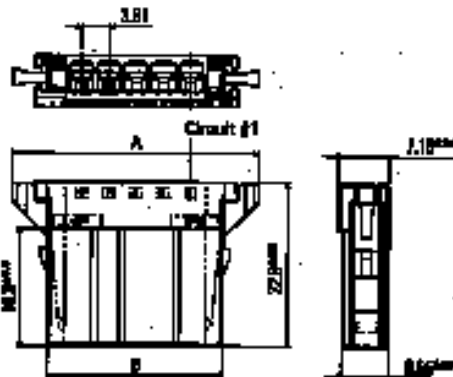

No. of Pos.	Part Number	Dimensions	
		A	B
3	□-178288-3	26.76	16.7
5	□-178288-5	34.38	24.32
8	□-178288-7	45.81	35.97

D-3000 Series (Continued)

D-3100S — Standard SMT Type (Continued)

■ **Board-mounting Tab Header (Horizontal Type)**

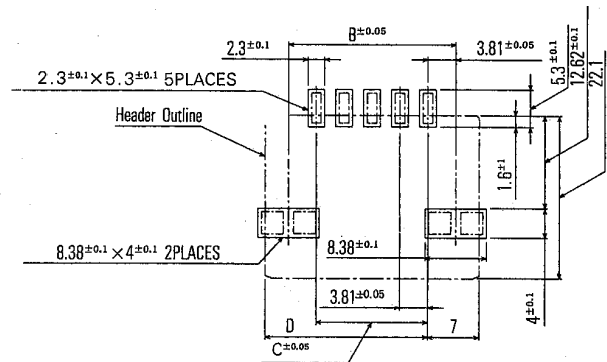
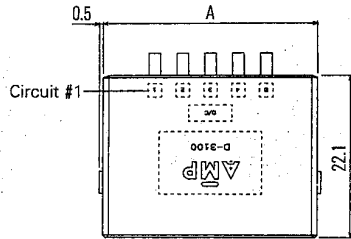
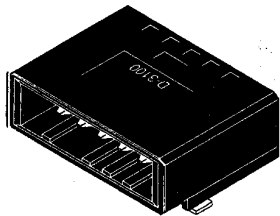

PC Board Layout

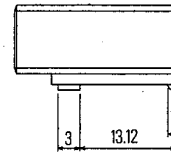
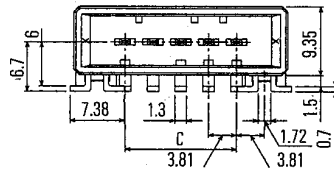

Tube Package Dimensions (Ref.)

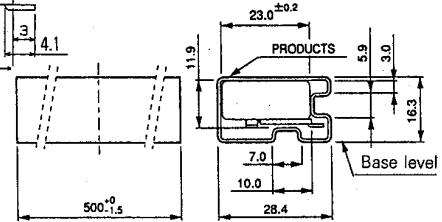

No. of Pos.	Part Number	Dimensions			
		A	B	C	D
3	—	—	—	—	—
5	□-177662-□	29.24	22.86	15.24	22.24
8	□-179188-□	40.67	34.29	26.67	33.67

■ **Board-mounting Tab Header (Vertical Type)**

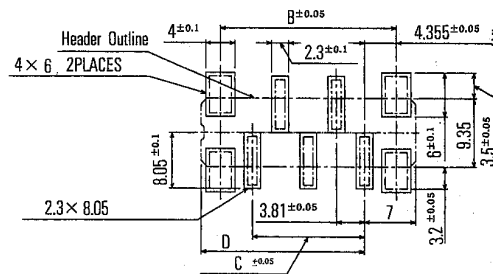
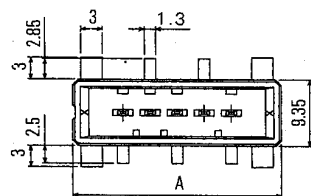
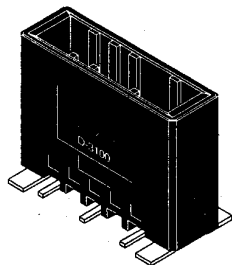

PC Board Layout

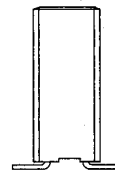
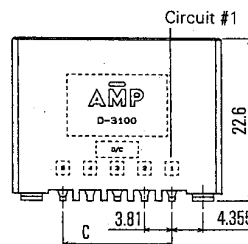

Tube Package Dimensions (Ref.)

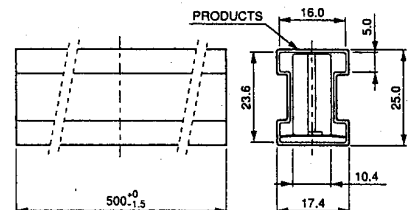

No. of Pos.	Part Number	Dimensions			
		A	B	C	D
3	—	—	—	—	—
5	□-177665-□	29.24	23.95	15.24	22.24
8	—	—	—	—	—

D-3000 Series (Continued)

**D-3100D — Standard
2-Row Type**

Appearance Board mounting pitch: Horizontal Type 150x150mils (3.81x3.81mm) / Vertical Type 150x200mils (3.81x5.08mm)
Dielectric Withstanding Voltage: 1,500V (for one minute)
Voltage Rating: 250V AC

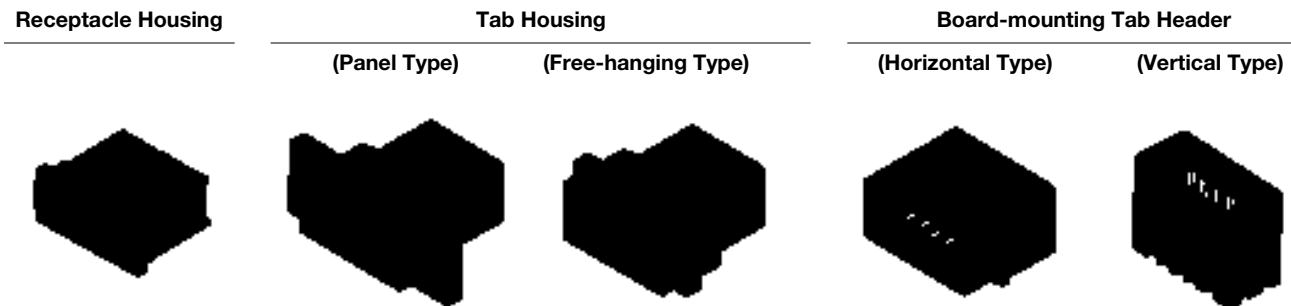
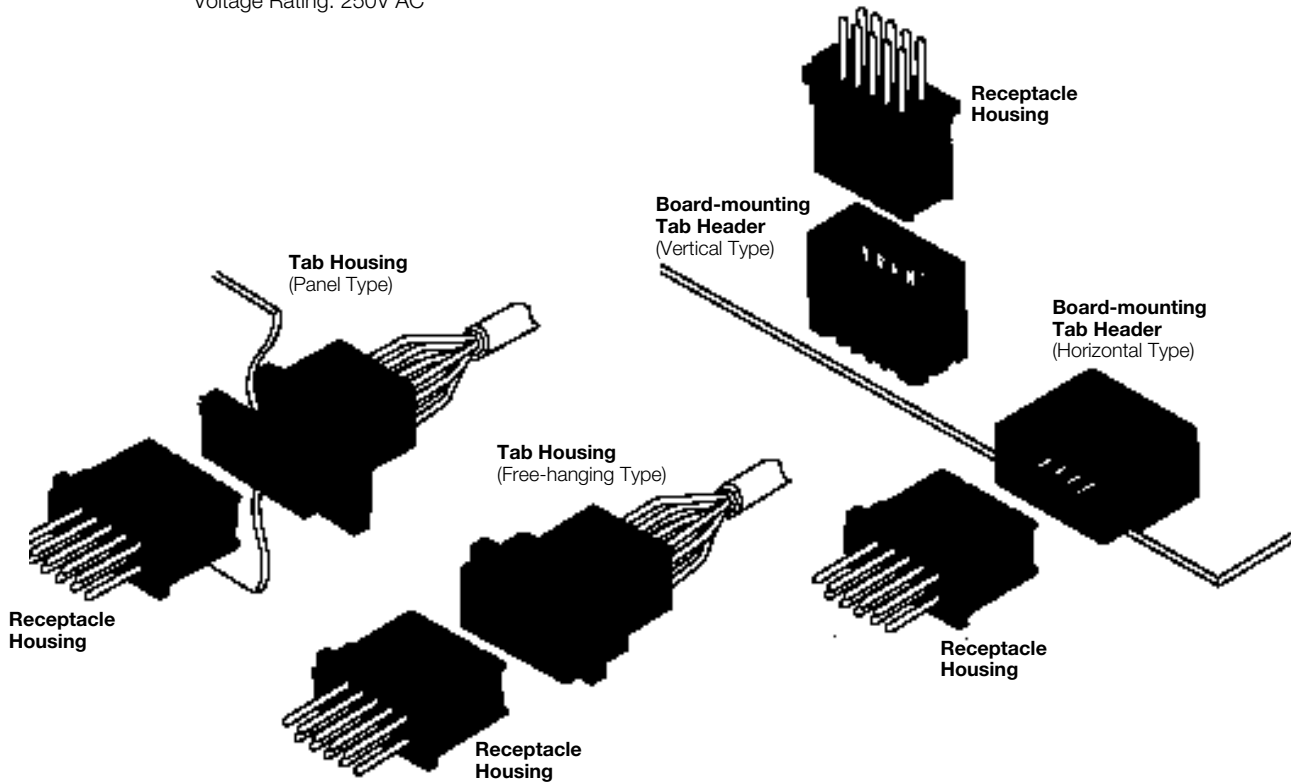

Part Number Chart

No. of Pos.	Receptacle Housing	Tab Housing			Board-mounting Tab Header	
		Panel Type	Free-hanging Type	L Fitting	Horizontal Type	Vertical Type
4	—	—	—	—	—	—
6	178289-3	178803-3	178964-3	S	178303-□	178323-□
10	178289-5	178803-5	178964-5	—	178305-□	178325-□
12	178289-6	178803-6	178964-6	—	178306-□	178326-□
16	178289-7	178803-7	178964-7	—	178307-□	178327-□
20	178289-8	178803-8	178964-8	—	178308-□	178328-□

Note: Enter the following plating codes in -□ after Part Numbers:
-2 = 0.38µm thick gold plating, -3 = 0.76µm thick gold plating,
-5 = Tin plating

D-3000 Series (Continued)

D-3100D — Standard 2-Row Type (Continued)

■ **Mating Dimensions**

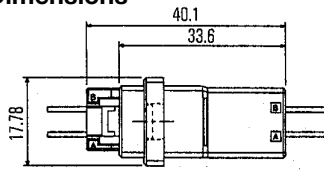

Panel/Free-Hanging Type

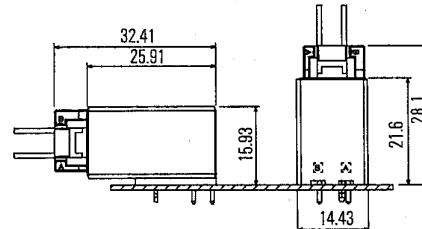

Horizontal/Vertical Type

■ **Receptacle Housing**

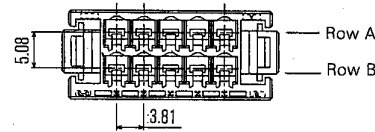
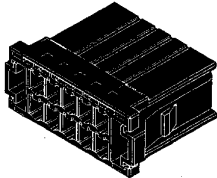

No. of Pos.	Receptacle Housing	Dimensions	
		A	B
4	—	—	—
6	178289-3	24.36	16.70
10	178289-5	31.98	24.32
12	178289-6	35.09	28.35
16	178289-7	42.71	35.97
20	178289-8	51.03	43.37

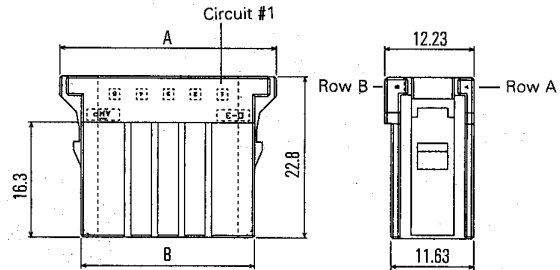

■ **Tab Housing**

Panel Type

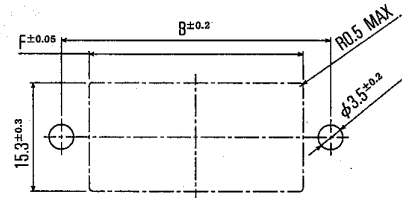
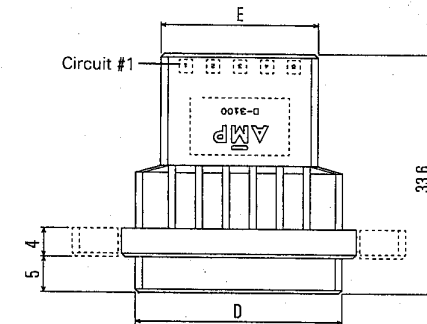
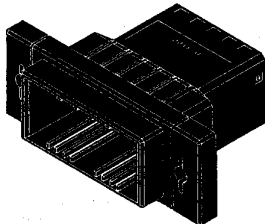

Panel Cutout

When mounting panel from the front, apply clamping torque of less than 49N [11 lbf].

Free-hanging Type

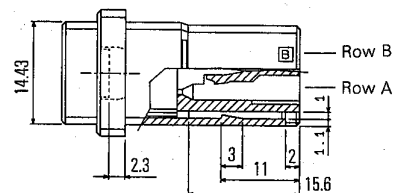
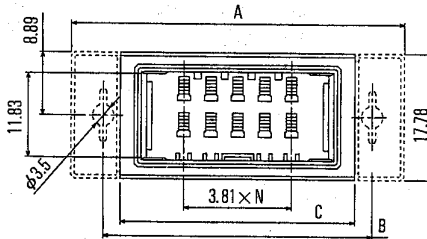
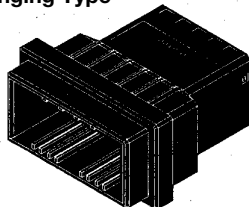

No. of Pos.	Part Number		Dimensions					
	Panel Type	Free-hanging Type	A	B	C	D	E	F
4	—	—	—	—	—	—	—	—
6	178803-3	178964-3	40	31	25.57	21.62	14.62	22.6
10	178803-5	178964-5	47	38	33.19	29.24	22.24	30.2
12	178803-6	178964-6	51	42	37.00	33.05	26.05	34.0
16	178803-7	178964-7	59	50	44.62	40.67	33.67	41.6
20	178803-8	178964-8	67	58	52.62	48.29	41.29	49.2

D-3000 Series (Continued)

D-3100M — Modular Type

Appearance

Connectors can be used in modular configurations in combination with D-3100S. Ideally Suited For Allocation of Signal Circuits
 Board mounting pitch: Horizontal Type 150x150mils (3.81x3.81mm) / Vertical Type 150x300mils (3.81x7.62mm)
 Dielectric Withstanding Voltage: 1,500V (for one minute)
 Voltage Rating: 250V AC

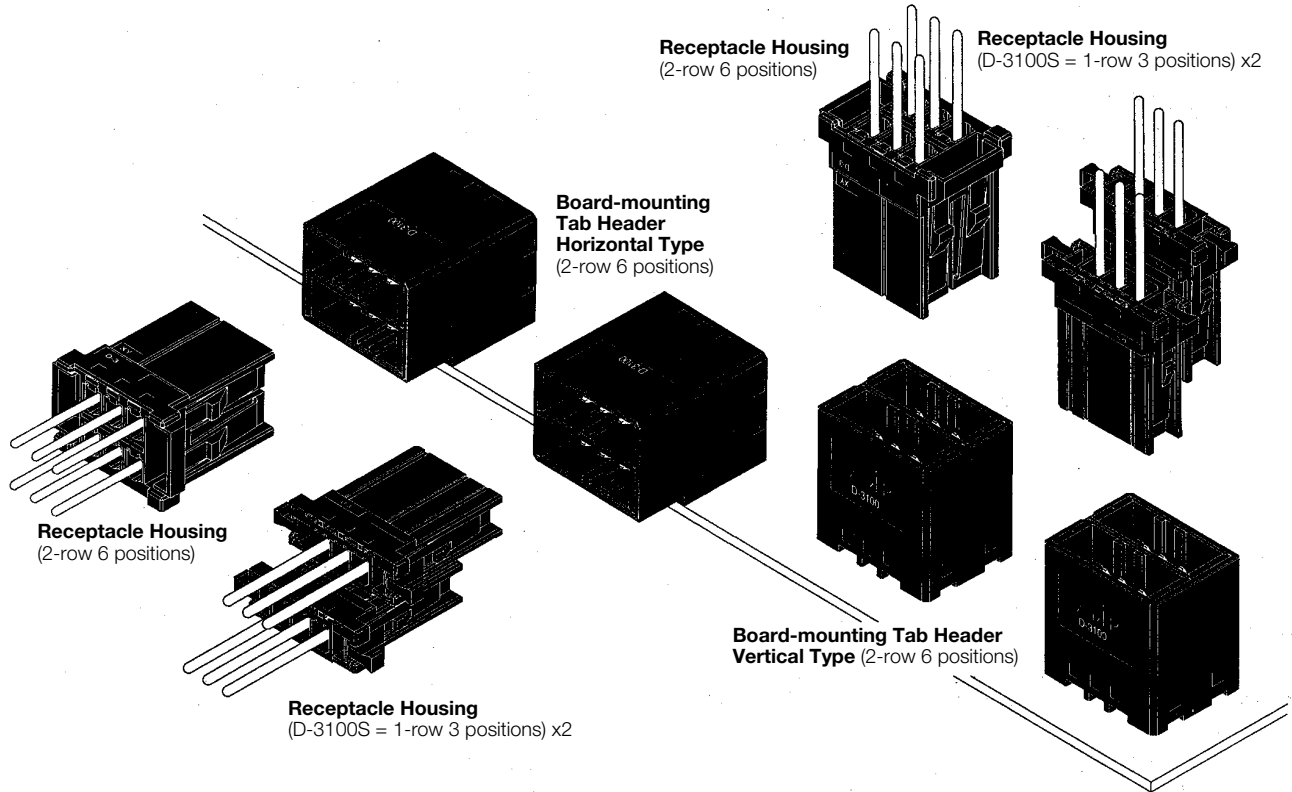

Receptacle Housing

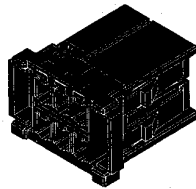

Board-mounting Tab Header

(Horizontal Type)

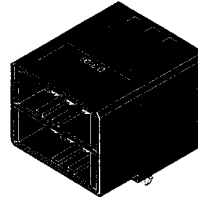

(Vertical Type)

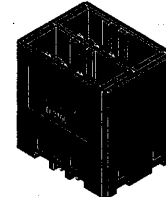

Part Number Chart

No. of Pos.	Keying	Receptacle Housing	Board-mounting Tab Header	
			Horizontal Type	Vertical Type
6	XX	1-178127-6	1-178137-□	1-178141-□
	YY	2-178127-6	2-178137-□	—
	XY	3-178127-6	3-178137-□	3-178141-□

Note: Enter the following plating codes in -□ after Part Numbers:
 -2 = 0.38µm thick gold plating
 -3 = 0.76µm thick gold plating
 -5 = Tin plating

D-3000 Series (Continued)

D-3100M — Modular Type

(Continued)

■ **Keying**

This product (D-3100M) is provided with keying to help prevent mismatching of connector halves. Keying is available in three types – XX Type, YY Type and XY Type. (Shown below is the mating surface of Tab Header.)

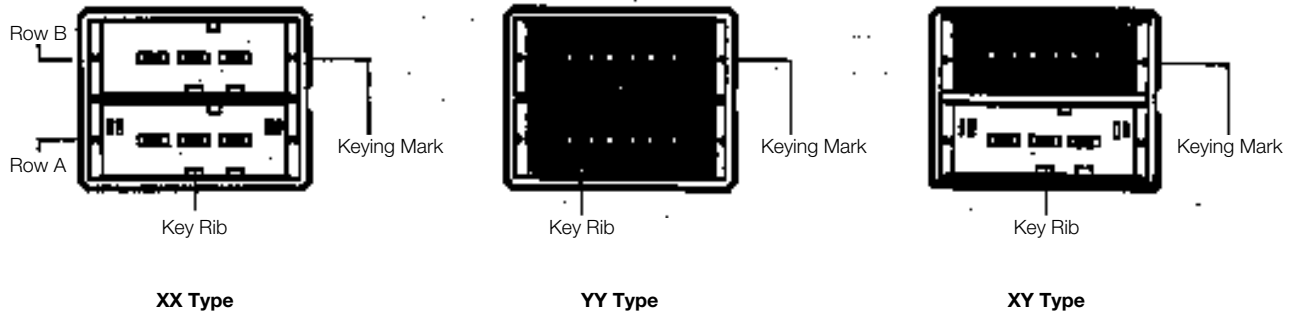

Table of Mating Combinations

Receptacle Housing		Board-mounting Tab Header				
		Horizontal Type		Vertical Type		
1 Row 3 positions (D-3100S) *	X Type P/N : 1-178288-3		1 Row 3 positions (D-3100S) *	X Type P/N : 1-178293-□	1 Row 3 positions (D-3100S) *	X Type P/N : 1-178313-□
	Y Type P/N : 2-178288-3		Y Type P/N : 2-178293-□	Y Type P/N : 2-178313-□		
2 Rows 6 positions 	XX Type P/N : 1-178127-6		2 Rows 6 positions *	XX Type P/N : 1-178137-□	2 Rows 6 positions *	XX Type P/N : 1-178141-□
	XX Type P/N : 2-178127-6		YY Type P/N : 2-178137-□	YY Type P/N : 2-178141-□		
	XY Type P/N : 3-178127-6		XY Type P/N : 3-178137-□	XY Type P/N : 3-178141-□		

The housing with asterisk (*) same as D-3100S Series.

D-3000 Series (Continued)

D-3100M — Modular Type

(Continued)

■ **Mating Dimensions**

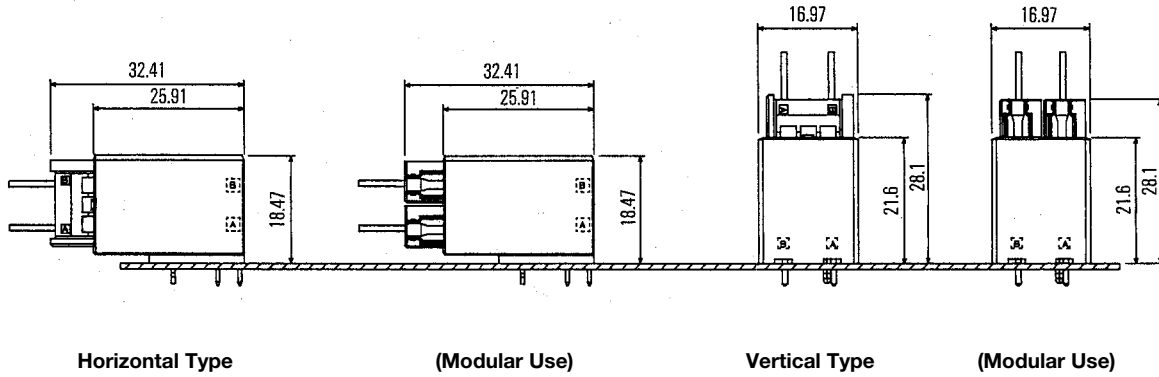

■ **Receptacle Housing**

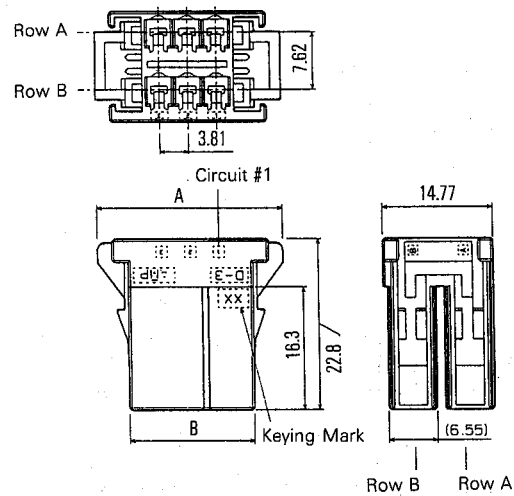
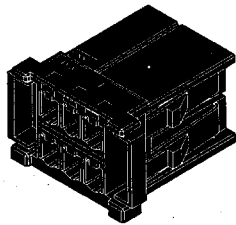

No. of Pos.	Part Number	Dimensions	
		A	B
6	□-178127-6	24.76	16.7

Notice:

*Although external or mounting dimensions are described in the catalog, the specifications are subject to change. When selecting products for your requirements, please request the appropriate drawings. Product Specifications, Instruction Sheets, etc., are also available. It is recommended that you request these documents as well.

D-3000 Series (Continued)

D-3100M — Modular Type

(Continued)

■ **Board-mounting Tab Header (Horizontal Type)**

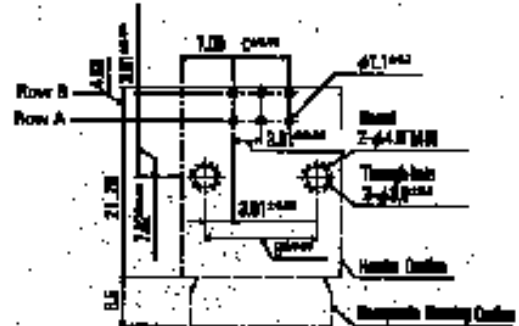
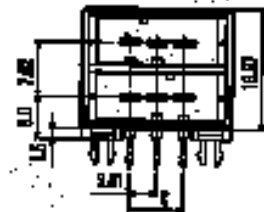
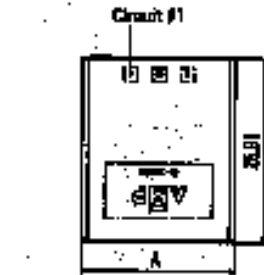

PC Board Layout

Acceptable Board Thickness:
1.6-2.4±0.1

Tube Package Dimensions (Ref.)



Solder tine section is 0.64 sq.

No. of Pos.	Part Number	Dimensions		
		A	B	C
6	□-178137-□	21.62	15.24	7.62

■ **Board-mounting Tab Header (Vertical Type)**

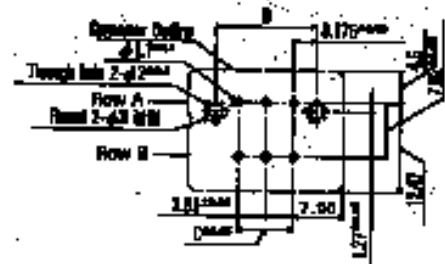
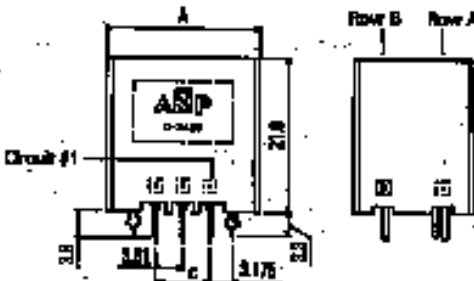

PC Board Layout

Acceptable Board Thickness:
1.6-2.4±0.1

Tube Package Dimensions (Ref.)



Solder tine section is 0.64 sq.

No. of Pos.	Part Number	Dimensions		
		A	B	C
6	□-178141-□	21.62	13.97	7.62

D-3000 Series (Continued)

D-3200S
(High-Voltage Version of
Standard D-3100S)

Appearance Board mounting pitch: Horizontal Type 200mils (5.08mm)
Dielectric Withstanding Voltage: 2,200V (for one minute)
Voltage Rating: 600V AC (per connector)

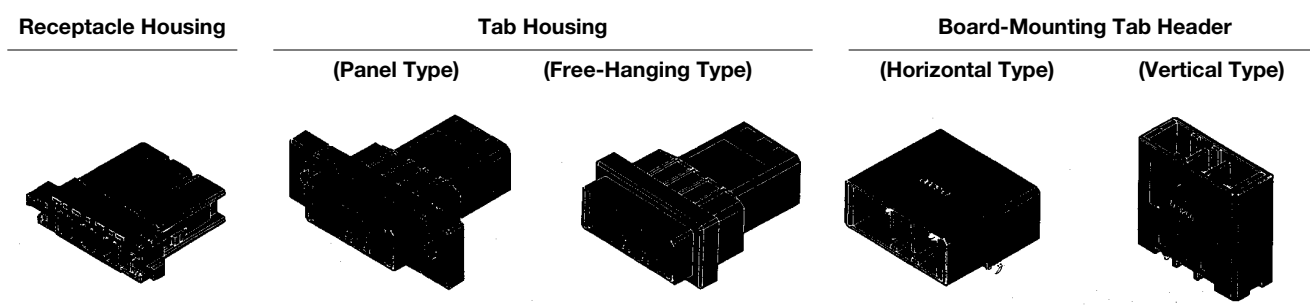
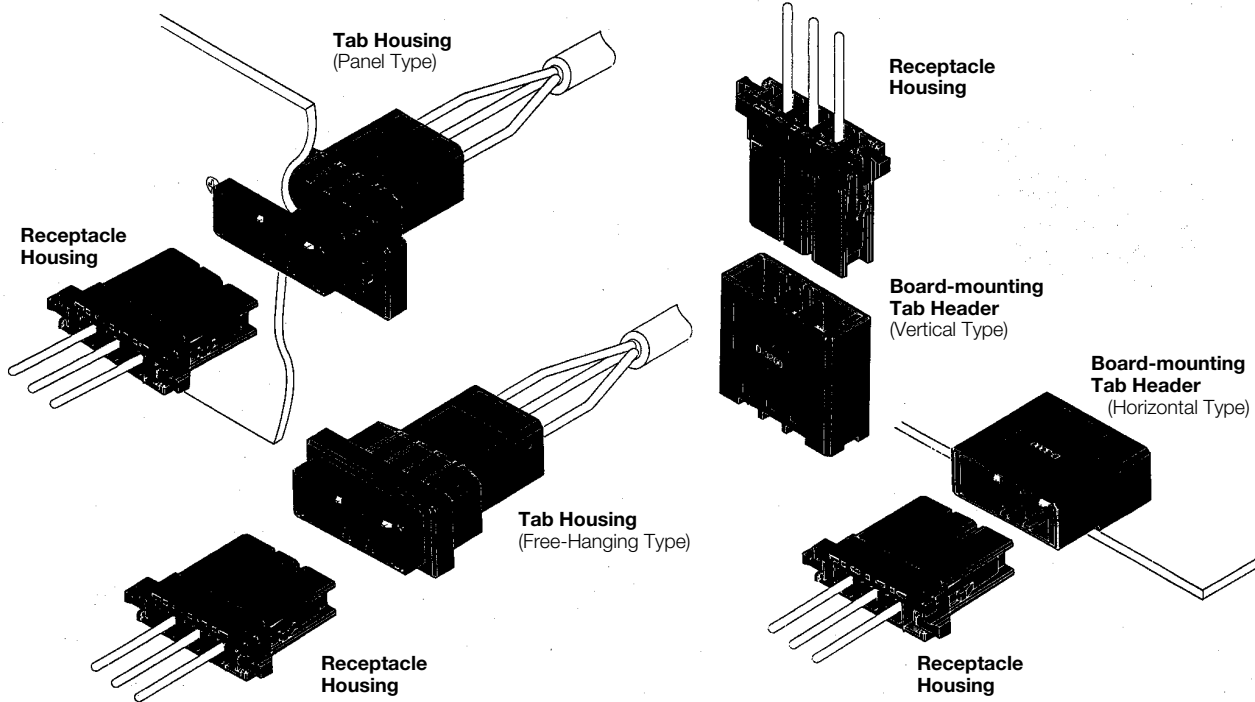

Part Number Chart

No. of Pos.	Keying	Receptacle Housing	Tab Housing			Board-mounting Tab Header	
			Panel Type	Free-Hanging Type	L Fitting	Horizontal Type	Vertical Type
2	X	1-178128-2	1-179553-2	1-179552-2	S	1-179276-□	1-917337-□
	Y	2-178128-2	2-179553-2	2-179552-2	S	2-179276-□	2-917337-□
3	X	1-178128-3*1	1-179553-3	1-179552-3	S	1-178138-□	1-178136-□
	Y	2-178128-3*1	2-179553-3	2-179552-3	S	2-178138-□	2-178136-□
4	X	1-178128-4	1-179553-4	1-179552-4	S	1-179277-□	1-917338-□
	Y	2-178128-4	2-179553-4	2-179552-4	S	2-179277-□	2-917338-□
5	X	1-178128-5*1	Use 2-row 6 position D-3200M, in place 5 and 6 position Panel and Free-hanging Types.			1-316130-□	1-316132-□
	Y	2-178128-5*1				2-316130-□	2-316132-□
6	X	1-178128-6*1				1-316131-□	1-316133-□
	Y	2-178128-6*1				2-316131-□	2-316133-□

Note: Enter the following plating codes in -□ after Part Numbers:
-2 = 0.38µm thick gold plating, -3 = 0.76µm thick gold plating,
-5 = Tin plating

*1 can also be used in modular configuration with D-3200M Tab Housing and Tab Header.

D-3000 Series (Continued)**D-3200S**
(High-Voltage Version of
Standard D-3100S) (Continued)**■ Keying**

This product (D-3200S) is provided with keying to help prevent mismatching of the connector halves. Keying is available in two types – X Type and Y Type . (Shown below is the mating surface of Tab Header.)



D-3000 Series (Continued)

D-3200S
(High-Voltage Version of
Standard D-3100S) (Continued)

Mating Dimensions

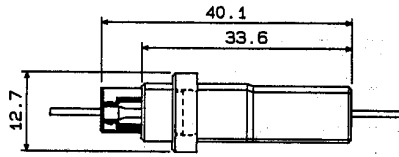

Panel/Free-Hanging Type

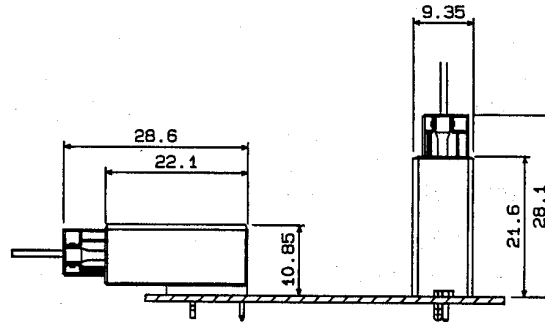

Horizontal/Vertical Type

External Dimensions

■ Receptacle Housing



5- and 6-position receptacle housings differ slightly in shape with each other. Check with diagram.

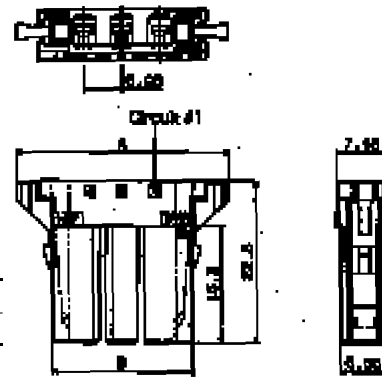

No. of Pos.	Part Number	Dimensions	
		A	B
2	□-178128-2	24.62	14.16
3	□-178128-3	29.7	19.24
4	□-178128-4	34.78	24.32
5	□-178128-5	39.86	29.4
6	□-178128-6	44.94	34.48

■ Tab Housing

Panel Type

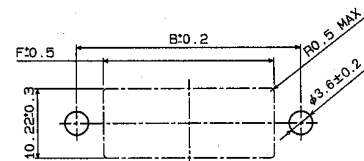
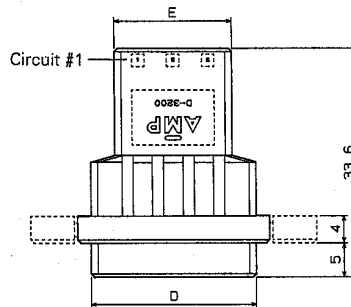
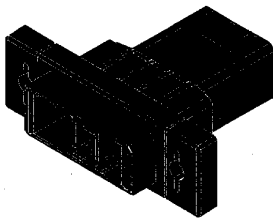

Panel Cutout

When mounting panel from the front, apply clamping torque of less than 49N [11 lbf].

Free-Hanging Type

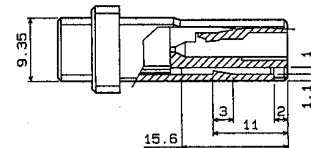
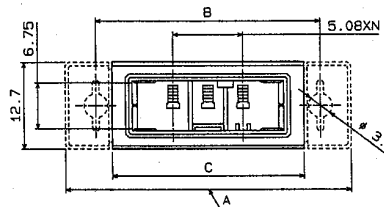
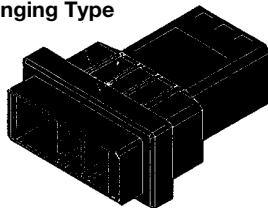

No. of Pos.	Part Number		Dimensions						
	Panel Type	Free-Hanging Type	A	B	C	D	E	F	
2	□-179553-2	□-179552-2	36.83	28	23.03	19.08	12.08	20	
3	□-179553-3	□-179552-3	41.91	33	28.11	24.16	17.16	25	
4	□-179553-4	□-179552-4	46.99	38	33.19	29.24	22.24	30	

D-3000 Series (Continued)

D-3200S
(High-Voltage Version of
Standard D-3100S) (Continued)

■ Board-mounting Tab Header (Horizontal Type)

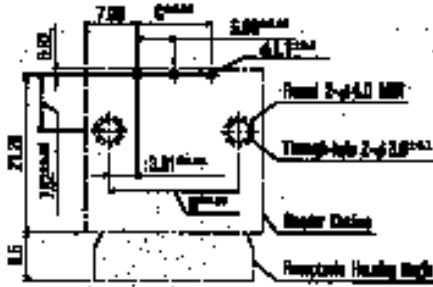
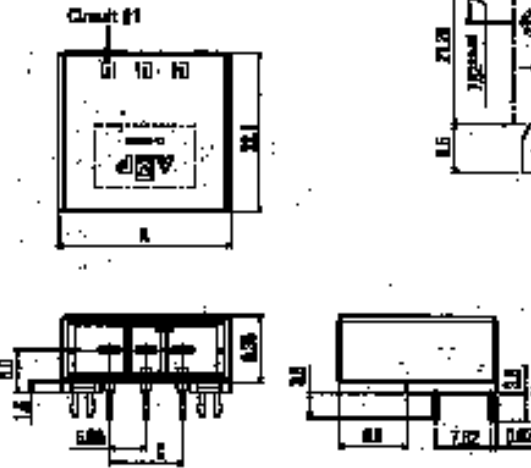
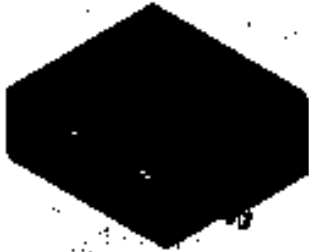

PC Board Layout
Acceptable Board Thickness:
1.6-2.4±0.1

Tube Package Dimensions (Ref.)

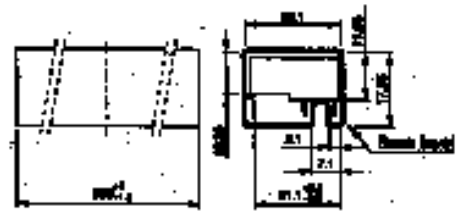

Solder tine section is 0.64 sq.

No. of Pos.	Part Number	Dimensions		
		A	B	C
2	□-179276-□	19.08	12.7	5.08
3	□-178138-□	24.16	17.78	10.16
4	□-179277-□	29.24	22.86	15.24
5	□-316130-□	34.32	27.84	20.32
6	□-316131-□	39.4	33.02	25.4

■ Board-mounting Tab Header (Vertical Type)

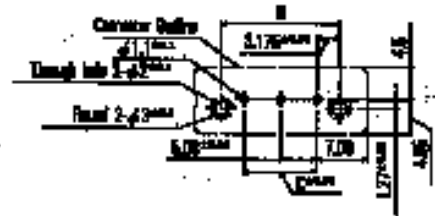
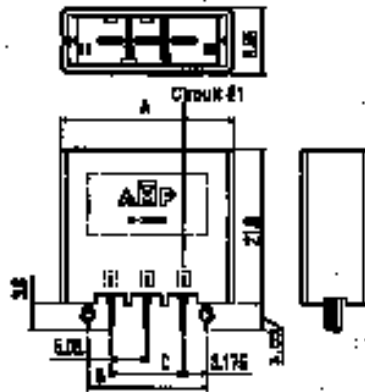

PC Board Layout
Acceptable Board Thickness:
1.6-2.4±0.1

Tube Package Dimensions (Ref.)

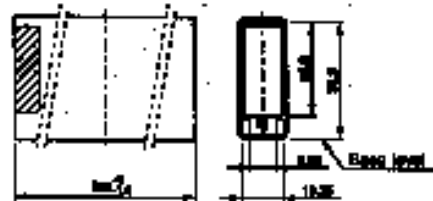

Solder tine section is 0.64 sq.

No. of Pos.	Part Number	Dimensions		
		A	B	C
2	□-917337-□	19.08	11.43	5.08
3	□-178136-□	24.16	16.51	10.16
4	□-917338-□	29.24	21.59	15.24
5	□-316132-□	34.32	26.67	20.32
6	□-316133-□	39.4	31.75	25.4

D-3000 Series (Continued)

D-3200S SMT Type

■ **Receptacle Housing and Board Mount Tab Header**

Appearance Dielectric Withstanding Voltage: 2,200V (1 min.)
Voltage Rating: 600V AC (when one connector is used)

Receptacle Housing

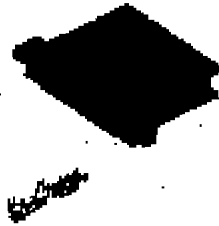

Board-Mounting Tab Header

(Horizontal Type)



Receptacle Contact.....For each line of contacts, refer to the appropriate page.

No. of Positions	Keying	Part Number of Receptacle Housing*	Part Number of Board-Mount Tab Header
			Horizontal Type
2	X	1-178128-2	—
3	X	1-178128-3	1-917389-□
4	X	1-178128-4	—
5	X	1-178128-5	—
6	X	1-178128-6	—

Note: Enter the following plating codes in Part Number suffix-□. Gold plating only for SMT Type.

-2 = 0.38µm thick gold plating,

-3 = 0.76µm thick gold plating

*Part Numbers are of the same design as D-3200S Series. For dimensions, refer to D-3200S Series.
Header material is PPS.

■ **Applications**

Servomotors/Inverters-Typical Applications

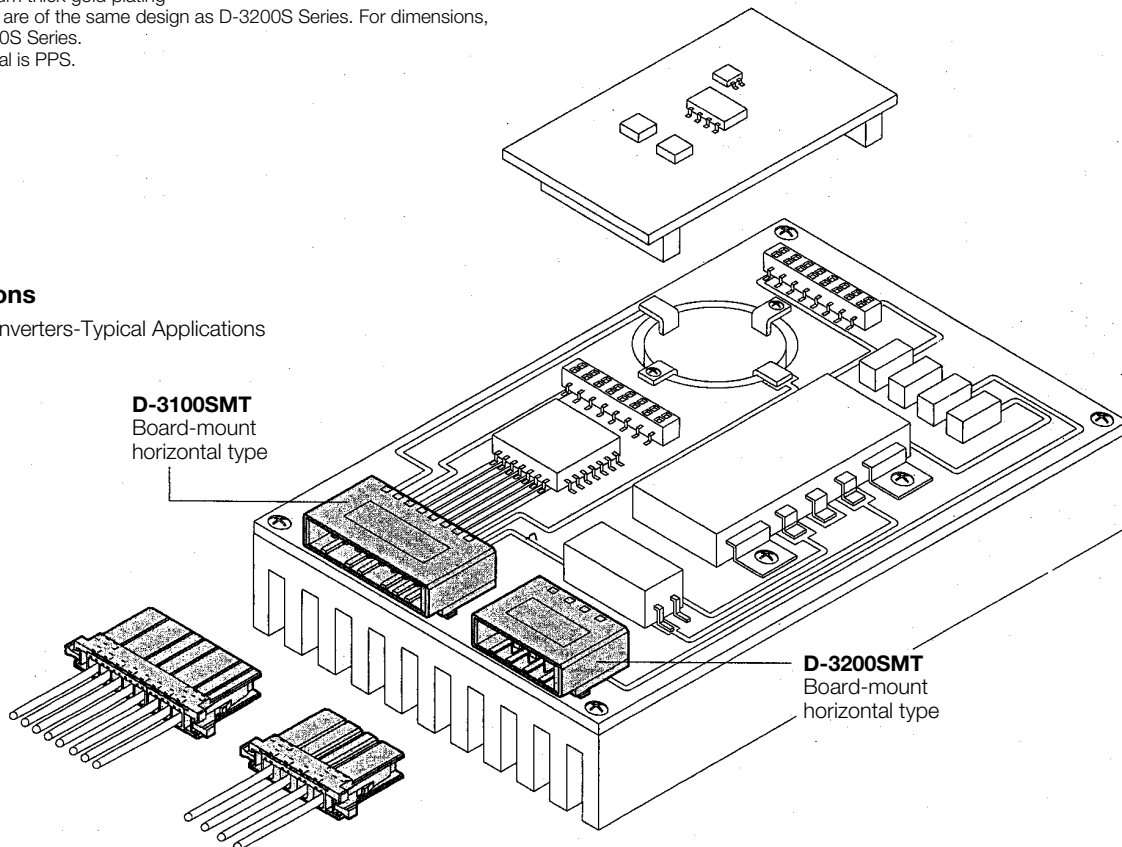

D-3100SMT
Board-mount
horizontal type

D-3200SMT
Board-mount
horizontal type

D-3000 Series (Continued)

D-3200M — Modular Type

Appearance

Connectors can be used in modular configurations in combination with D-3200S. Ideally suited for allocation of power circuits.
 Board mounting pitch: Horizontal Type 200x200mils (5.08x5.08mm)
 Vertical Type 200x300mils (5.08x7.62mm)
 Dielectric Withstanding Voltage: 2,200V (for one minute)
 Voltage Rating: 600V AC (per connector)

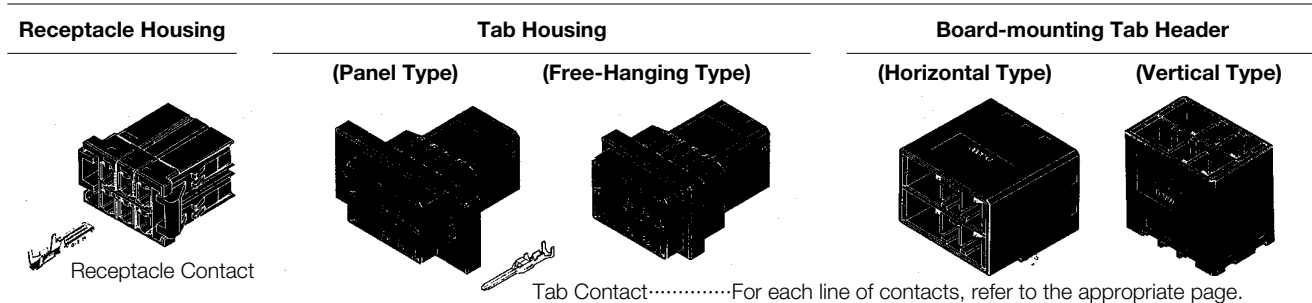
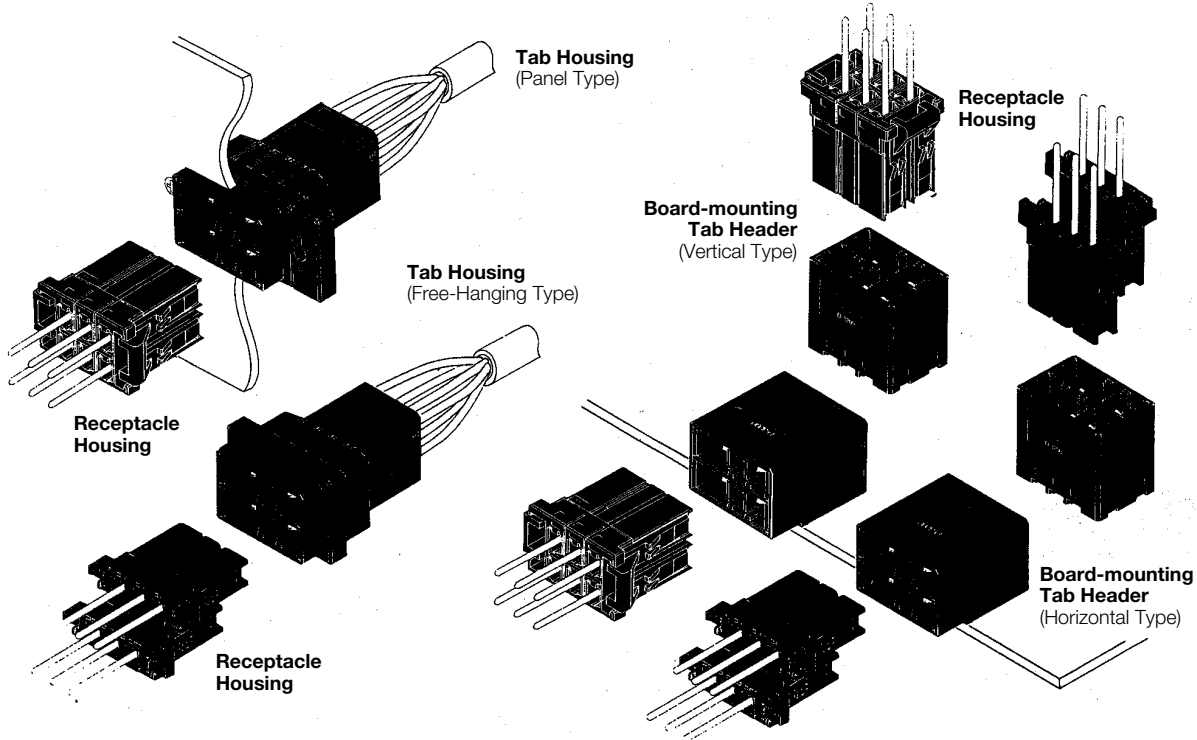

Tab Contact.....For each line of contacts, refer to the appropriate page.

Part Number Chart

No. of Pos.	Keying	Receptacle Housing	Tab Housing*			Board-Mounting Tab Header*	
			Panel Type	Free-Hanging Type	L Fitting	Horizontal Type	Vertical Type
6	XX	1-178129-6	1-179555-3	1-179554-3	S	1-178139-□	1-178140-□
	YY	2-178129-6	2-179555-3	2-179554-3	S	2-178139-□	2-178140-□
	XY	3-178129-6	3-179555-3	3-179554-3	S	3-178139-□	3-178140-□
10	XX	1-917659-5	—	—	—	1-316080-□	1-917657-□
	YY	2-917659-5	—	—	—	2-316080-□	2-917657-□
	XY	3-917659-5	—	—	—	3-316080-□	3-917657-□
12	XX	1-917659-6	1-179555-6	1-179554-6	—	1-316081-□	1-917658-□
	YY	2-917659-6	2-179555-6	2-179554-6	—	2-316081-□	2-917658-□
	XY	3-917659-6	3-179555-6	3-179554-6	—	3-316081-□	3-917658-□
20	XX	1-917659-8	1-179555-8	—	—	—	—

Note: Enter the following plating codes in -□ after Part Numbers:
 -2 = 0.38µm thick gold plating, -3 = 0.76µm thick gold plating,
 -5 = Tin plating

* Can also be used in Drawer connector in combination with D-3200M Drawer Type.

D-3000 Series (Continued)

D-3200M — Modular Type

(Continued)

■ **Keying**

This product (D-3200M) is provided with keying to help prevent mismatching of the connector halves. Keying is available in three types – XX Type, YY Type and XY Type. (Shown below is the mating surface of Tab Header.)

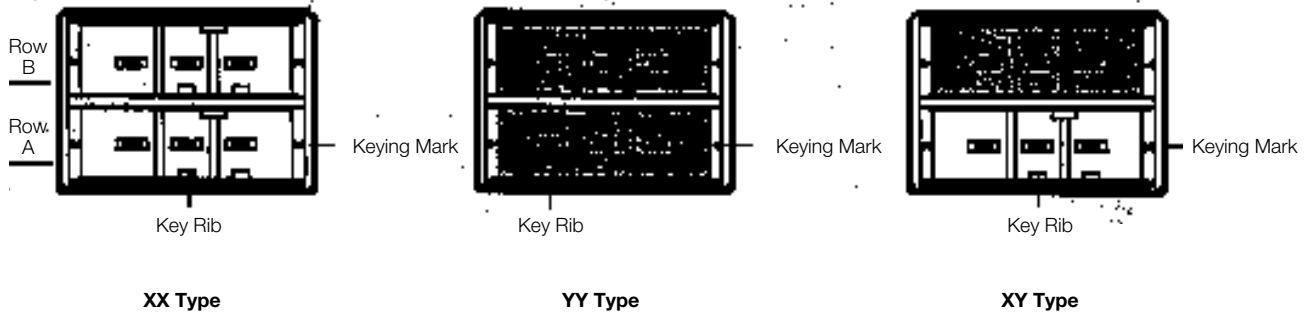

Table of Mating Combinations

Receptacle Housing		Tab Housing		Board-mounting Tab Header	
1 Row 3 Positions (D-3200S) *	X Type	1 Row, 3 Pos. (D-3200S) Panel Type *	X Type Panel Type Free-Hanging Type	1 Row, 3 Pos. (D-3200S) Horizontal Type *	X Type Horizontal Type Vertical Type
	Y Type	Free-Hanging Type *	Y Type Panel Type Free-Hanging Type	Vertical Type *	Y Type Horizontal Type Vertical Type
2 Rows 6 Positions *	XX Type	2 Rows 6 Positions Panel Type *	XX Type Panel Type Free-Hanging Type	2 Rows 6 positions Horizontal Type *	XX Type Horizontal Type Vertical Type
	YY Type	Free-Hanging Type *	YY Type Panel Type Free-Hanging Type	Vertical Type *	YY Type Horizontal Type Vertical Type
	XY Type	Free-Hanging Type *	XY Type Panel Type Free-Hanging Type	Vertical Type *	XY Type Horizontal Type Vertical Type

The housing with asterisk (*) same as D-3200S Series.

D-3000 Series (Continued)

D-3200M — Modular Type

(Continued)

Mating Dimensions

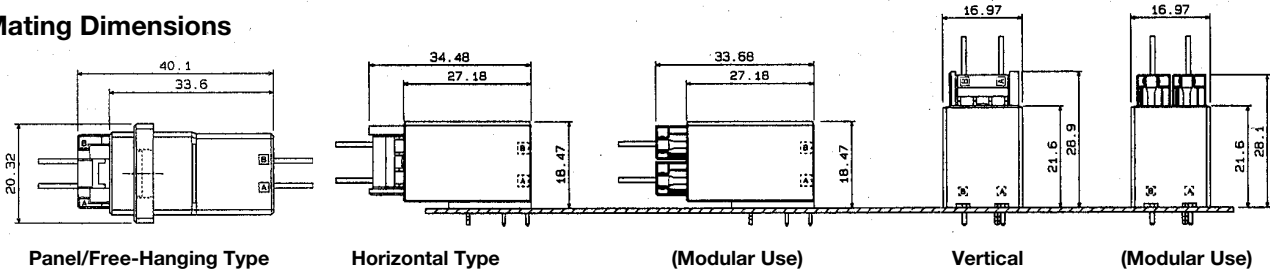

External Dimensions

■ Receptacle Housing

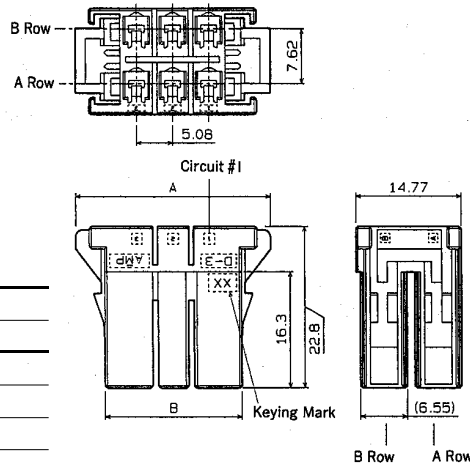
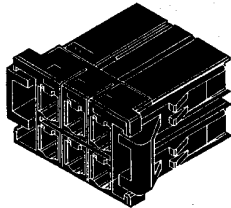

No. of Pos.	Part Number	Dimensions	
		A	B
6	□-178129-6	27.3	19.24
10	□-917659-5	37.46	29.4
12	□-917659-6	42.54	34.48
20	□-917659-8	62.86	54.8

■ Tab Housing

Panel Type

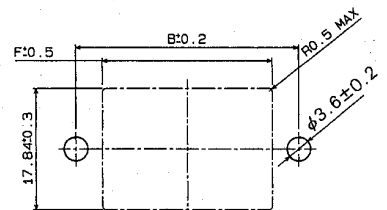
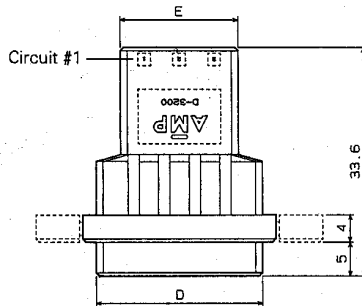
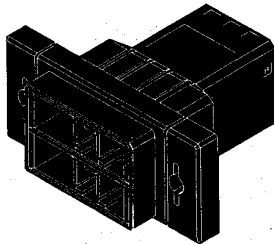

Panel Cutout

When mounting panel from the front, apply clamping torque of less than 49N [11 lbf].

Free-Hanging Type

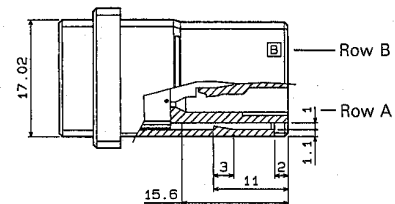
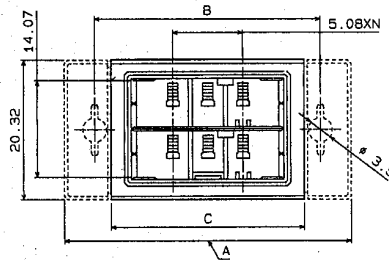
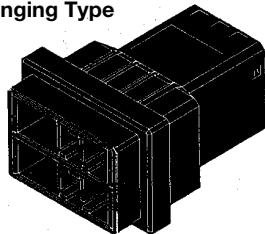

No. of Pos.	Part Number		Dimensions					
	Panel Type	Free-Hanging Type	A	B	C	D	E	F
6	□-179555-3	□-179554-3	41.91	33	28.11	24.16	17.16	25
12	□-179555-6	□-179554-6	57.91	49	43.35	39.4	32.4	41
20	□-179555-8	—	78.23	70	—	59.72	52.72	61

D-3000 Series (Continued)

D-3200M — Drawer Type

Appearance Board mounting pitch: Horizontal Type 200x200 mils (5.08x5.08mm)
 Vertical Type 200x300mils (5.08x7.62mm)
 Dielectric Withstanding Voltage: 2,200V (for one minute) Voltage Rating: 600V AC (per connector)

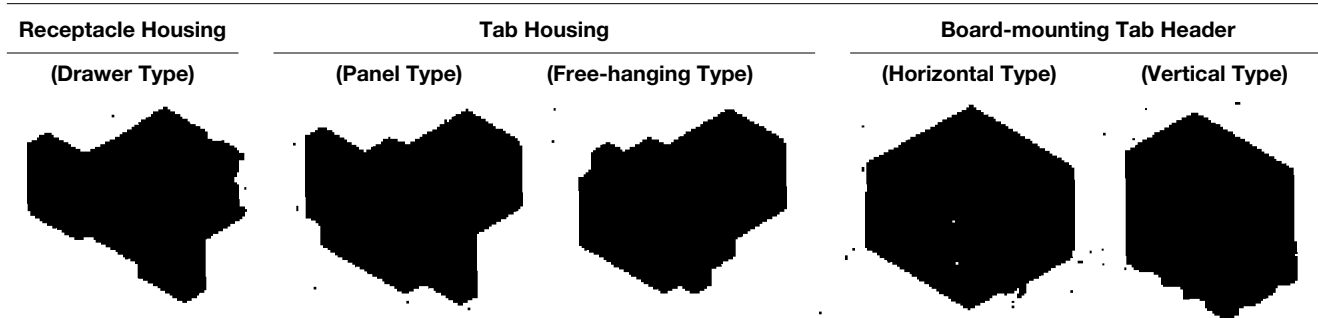
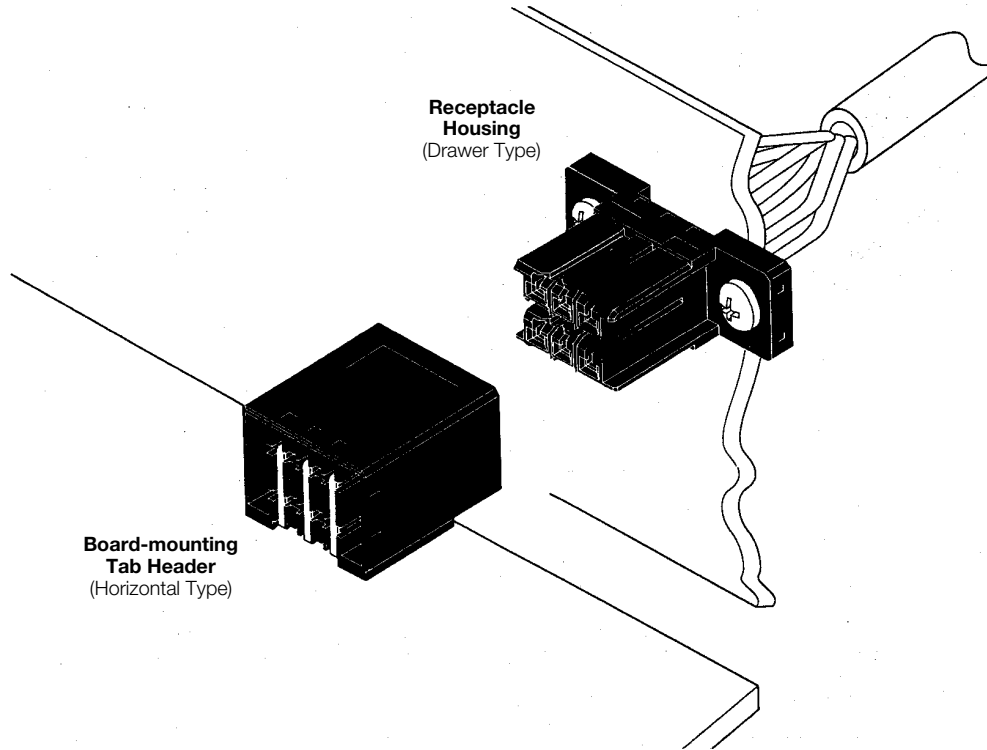

Part Number Chart

No. of Pos.	Keying	Receptacle Housing (Drawer Type)	Tab Housing*		Board-mounting Tab Header*	
			Panel Type	Free-Hanging Type	Horizontal Type	Vertical Type
6	XX	1-917266-3	1-179555-3	1-179554-3	1-178139-□	1-178140-□
	YY	—	2-179555-3	2-179554-3	2-178139-□	2-178140-□
	XY	—	3-179555-3	3-179554-3	3-178139-□	3-178140-□

Note: Enter the following plating codes in -□ after Part Numbers:
 -2 = 0.38µm thick gold plating, -3 = 0.76µm thick gold plating,
 -5 = Tin plating

Panel Mounting Screw

Part Number
900167-1

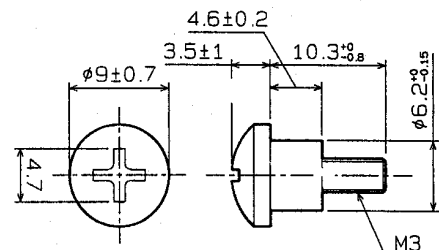
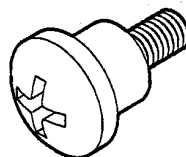

D-3000 Series (Continued)

D-3200M — Drawer Type

(Continued)

■ **Board-mounting Tab Header (Horizontal Type)**

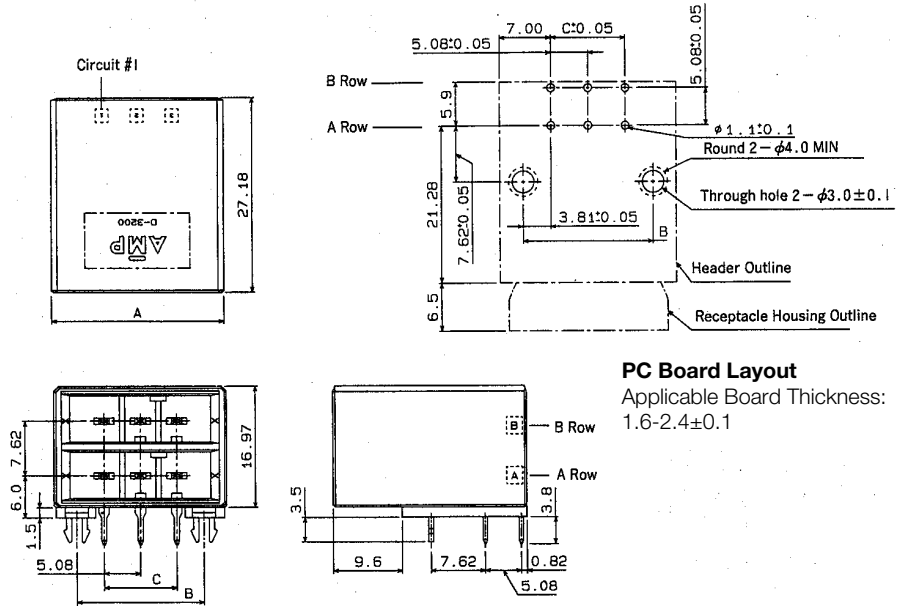
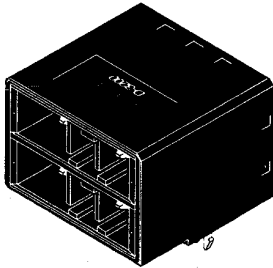

PC Board Layout
Applicable Board Thickness:
1.6-2.4±0.1

Solder tine section is 0.64 sq.

No. of Pos.	Part Number	Dimensions		
		A	B	C
6	□-178139-□	24.16	17.78	10.16

■ **Board-mounting Tab Header (Vertical Type)**

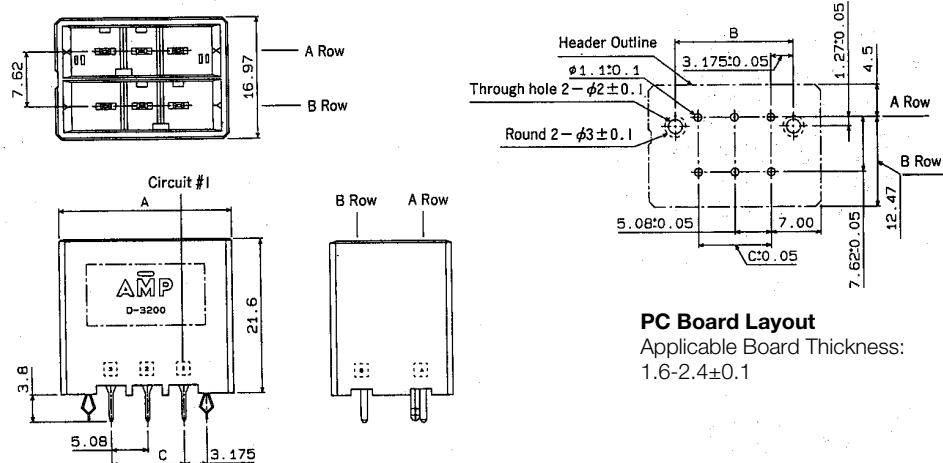
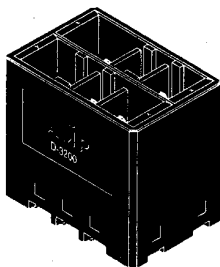

PC Board Layout
Applicable Board Thickness:
1.6-2.4±0.1

Solder tine section is 0.64 sq.

No. of Pos.	Part Number	Dimensions		
		A	B	C
6	□-178140-□	24.16	16.51	10.16

D-3000 Series (Continued)

D-3200T — 3-Row Type

Appearance Board-mounting pitch: Horizontal Type 200x200mils (5.08x5.08mm)
Dielectric Withstanding Voltage: 2,200V (for one minute) Voltage Rating: 600V AC (per connector)

Receptacle Housing

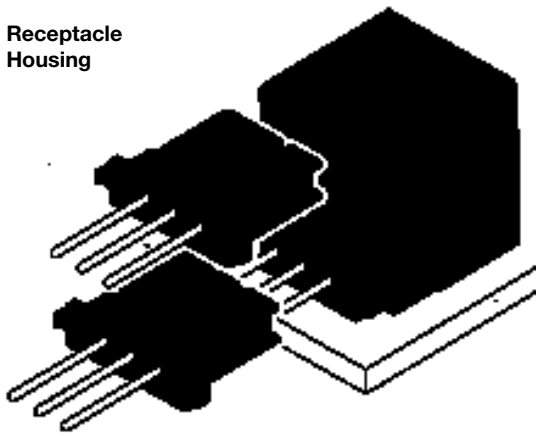

Mating Dimensions

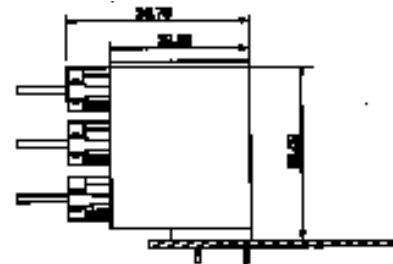

Horizontal Type

Keying

This product (D-3200T) is provided with keying to help prevent mismatching of the connector halves. Keying is available in four types-XXX Type, XXY Type, YYX Type and YXX Type. (Shown below is the mating surface of Tab Header.)

Part Number Chart

No. of Pos.	Keying	Board-mounting Tab Header
		Horizontal Type
9	XXX	1-1123624-□
	XXY	3-1123624-□
	YYX	4-1123624-□
	YXX	5-1123624-□

Note: Enter following plating codes in-□ after Part Numbers:
-2 : 0.38µm thick gold plating
-5 : Tin plating



XXX Type



XXY Type



YYX Type



YXX Type

Board-mount Tab Header (Horizontal Type)

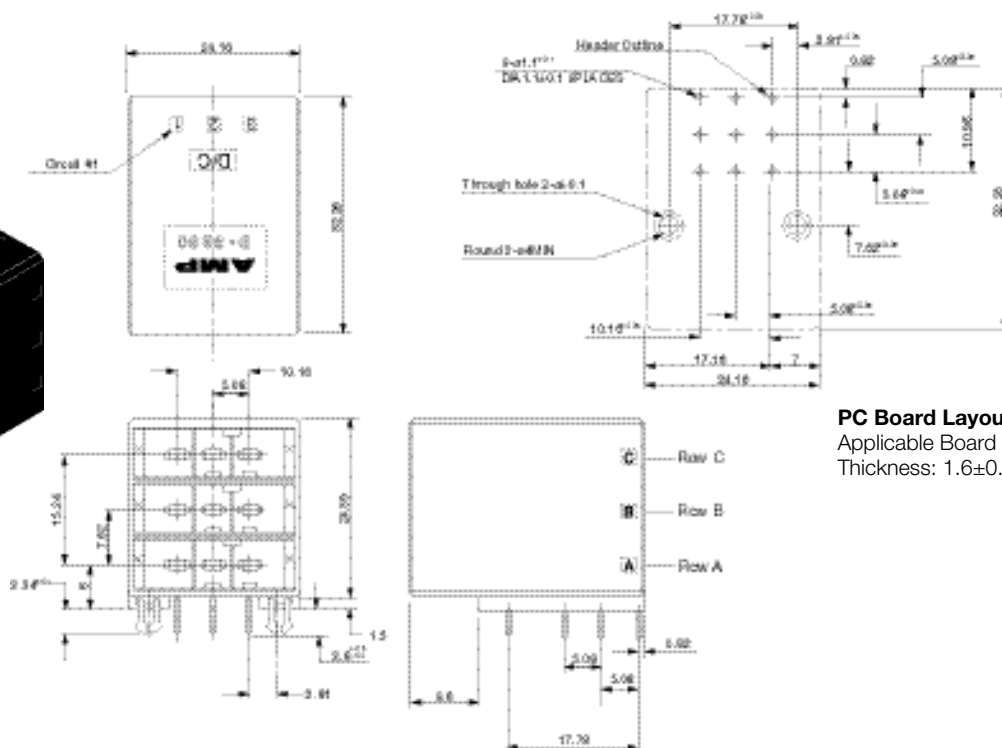

D-3000 Series (Continued)

D-3400F — Skyscraper Connectors

Appearance Board-mounting width reduced through increased heights. Compatible with increased I/Os.
 Board-mounting pitch: Horizontal Type 150x150 mils (3.81x3.81 mm)
 Dielectric Withstanding Voltage: 1,500V (for one minute) Voltage Rating: 250V AC

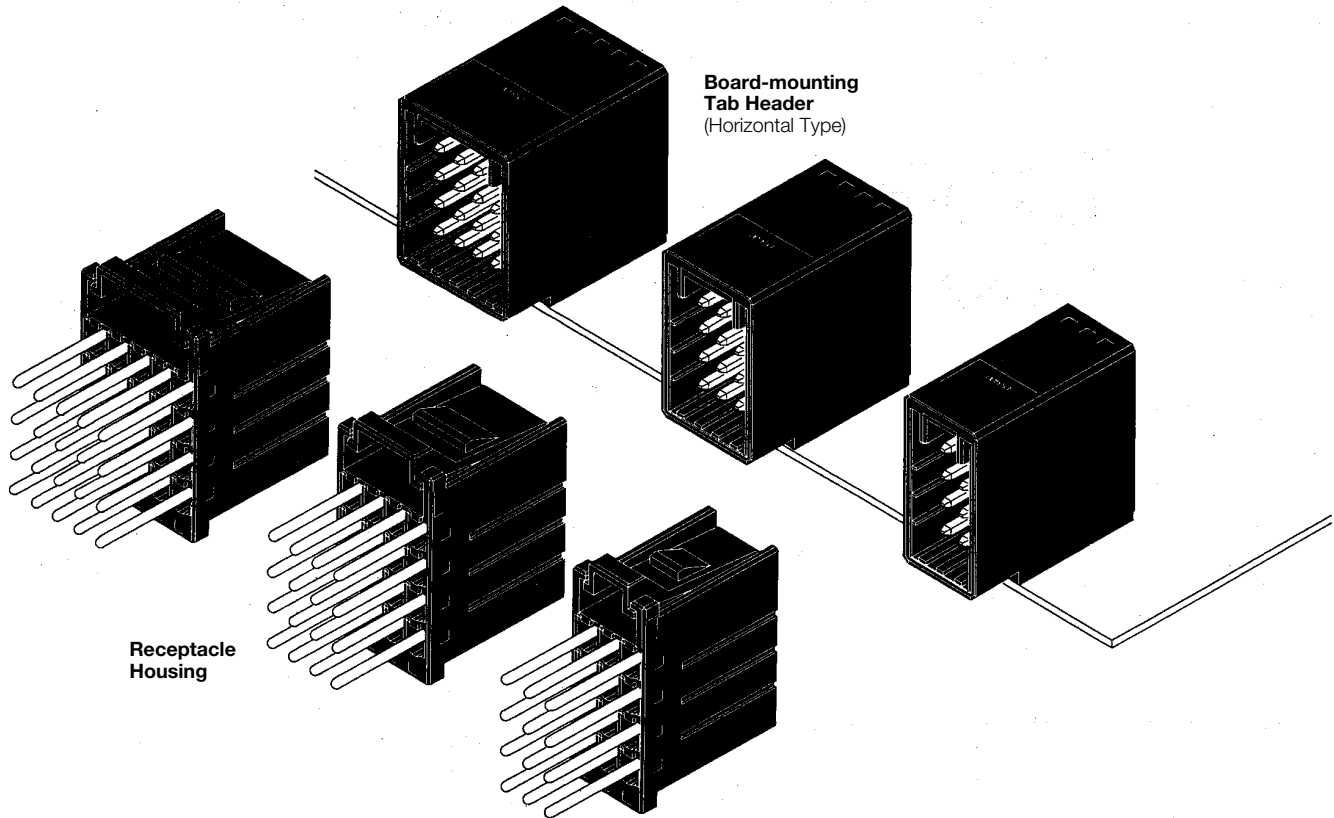

Receptacle Housing

Board-mounting Tab Header
(Horizontal Type)

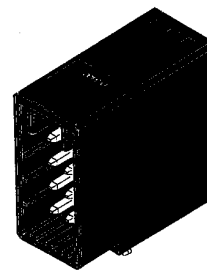
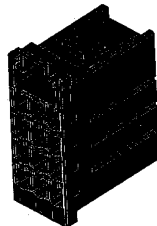

Part Number Chart

No. of Pos.	Receptacle Housing	Board-mounting Tab Header (Horizontal Type)
12	178214-1	178216-□
16	—	—
20	917249-1	917251-□

Note: Enter the following plating codes in -□ after Part Numbers:
 -2 = 0.38µm thick gold plating, -3 = 0.76µm thick gold plating,
 -5 = Tin plating

D-3000 Series (Continued)

D-3400F — Skyscraper Connectors (Continued)

Mating Dimensions

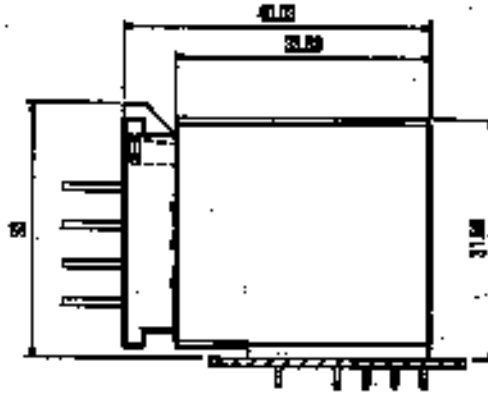

Horizontal Type

■ Receptacle Housing

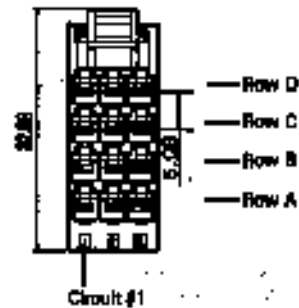

No. of Pos.	Part Number	Dimensions
		A
12	178214-1	12.22
16	—	—
20	917249-1	19.84

D-3000 Series (Continued)

D-3400F — Skyscraper Connectors (Continued)

■ **Board-mounting Tab Header (Horizontal Type)**

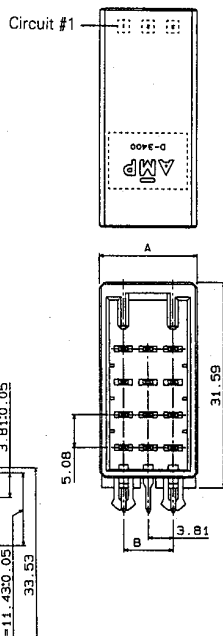
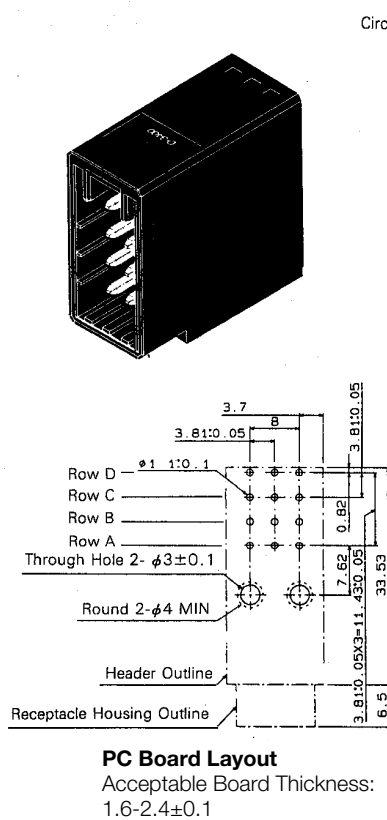

Tube Package Dimensions For 12 Pos.

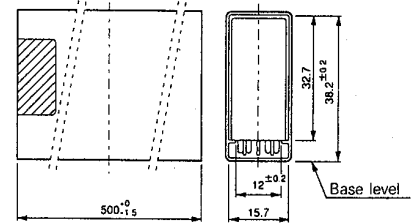

For 20 Pos.

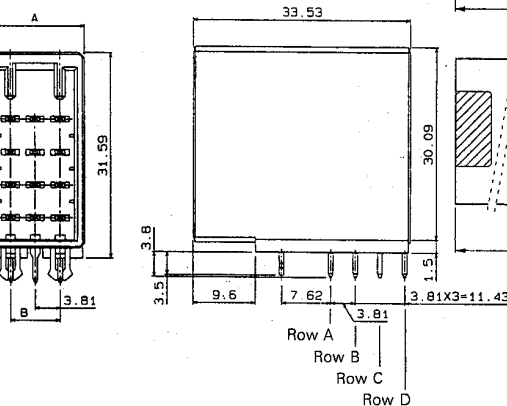
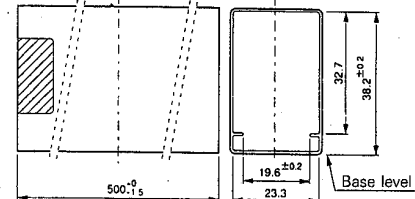

Solder tine section is 0.64 sq.

No. of Pos.	Part Number	Dimensions	
		A	B
12	178216-□	15.02	7.62
16	—	—	—
20	917251-□	22.64	15.24

Testing Advice

There are two major causes for faulty contact of the connector. They are:

- (1) Scooping of contacts at mating/unmating
 - With this Dynamic Series, each connector is designed to protect contacts against scooping very effectively.
- (2) Widening of contact gap by forcing tester bar, etc., into receptacle contacts when making continuity check.
 - Test bars that are commercially available (2 mm) cannot be pushed in from the entry port of housing. Never do continuity check by inserting clips, etc. Failure may also be caused by mis-insertion of the extraction tool. Be careful when you use the tool.

(Recommended methods of continuity check)

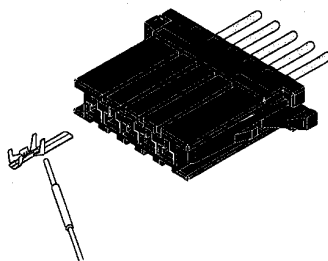

① Utilize tab contacts.

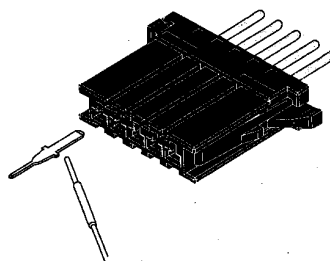

② Extract contacts from Board-mounting Vertical Type connector and insert them for testing.

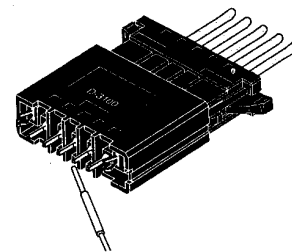

③ The best method is to use Board-mounting Vertical type connector.

D-3000 Series (Continued)

D-3500D — Sensor Connectors

Appearance Ideally suited for sensors used in robotics and machine tools. Also used for power distribution.
 Board mounting pitch: 200x200mils (5.08x5.08mm)
 Dielectric Withstanding Voltage: 2,200V (for one minute)
 Voltage Rating: 600V (per connector)

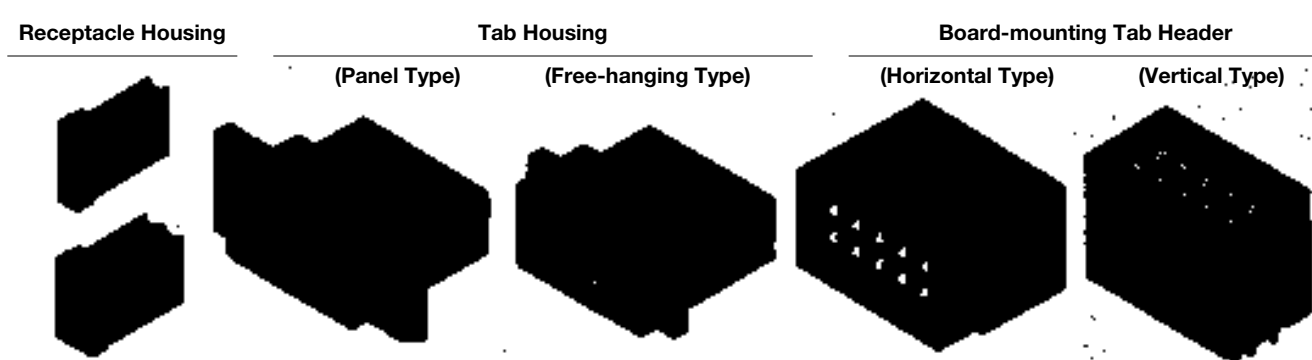
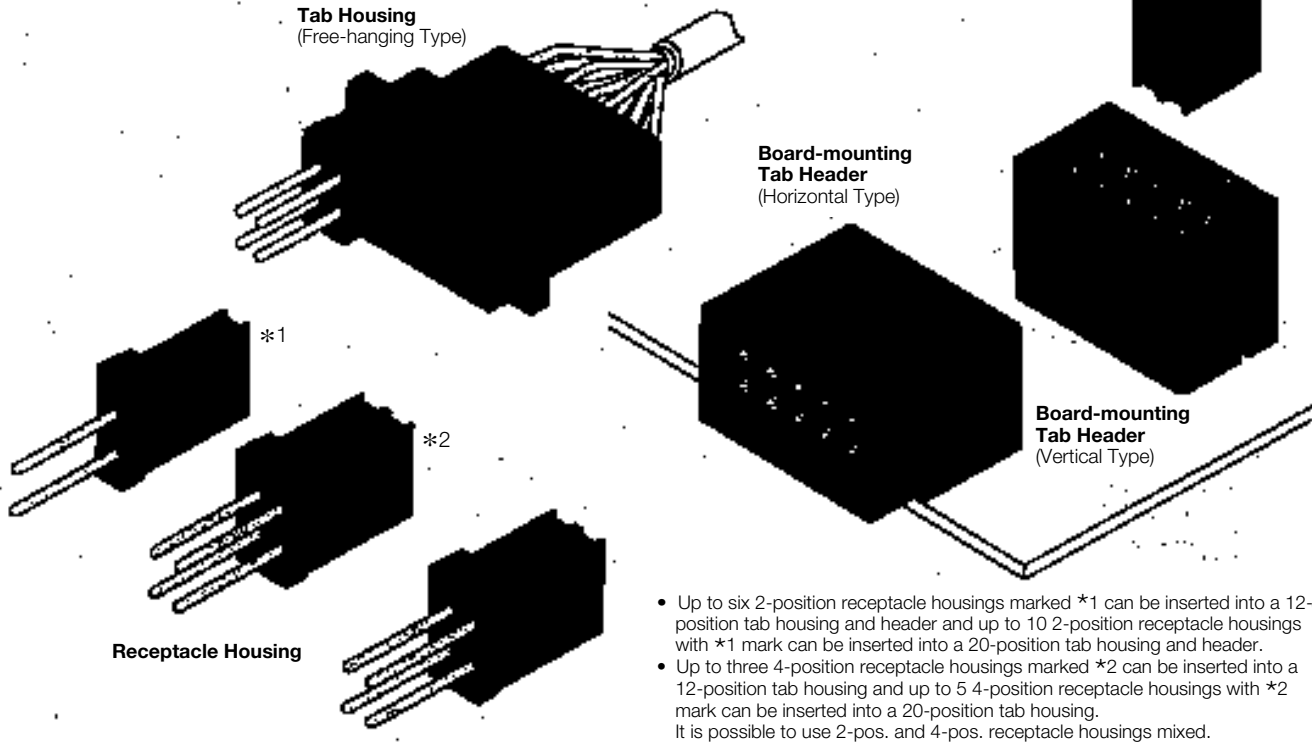

No. of Pos.	Receptacle Housing	Tab Housing		L Fitting	Board-mounting Tab Header	
		Panel Type	Free-hanging Type		Horizontal Type	Vertical Type
2	175362-□	—	—	—	—	—
4	175363-□	—	—	—	1376133-□	—
12	—	□-917241-6	□-917242-6	S	177555-□	316516-□
20	—	□-917241-8	□-917242-8	S	175365-□	316517-□

Note : Enter the following plating codes in -□ after Part Numbers:
 -2 = 0.38µm thick gold plating, -3 = 0.76µm thick gold plating,
 -5 = Tin plating

D-3000 Series (Continued)

D-3500D — Sensor Connectors (Continued)

Mating Dimensions

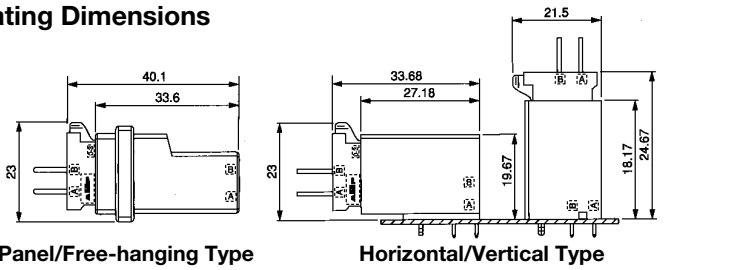

■ **Receptacle Housing (2 Positions)**

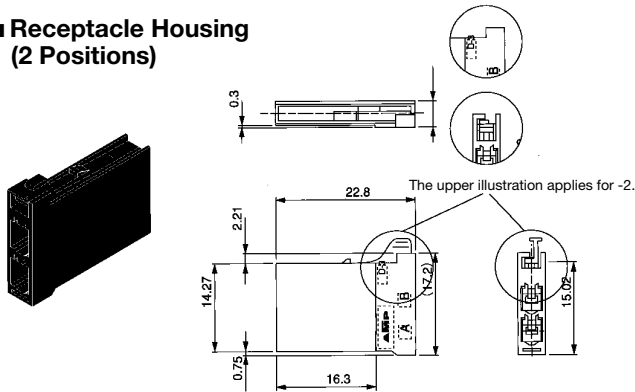

■ **Receptacle Housing (4 Positions)**

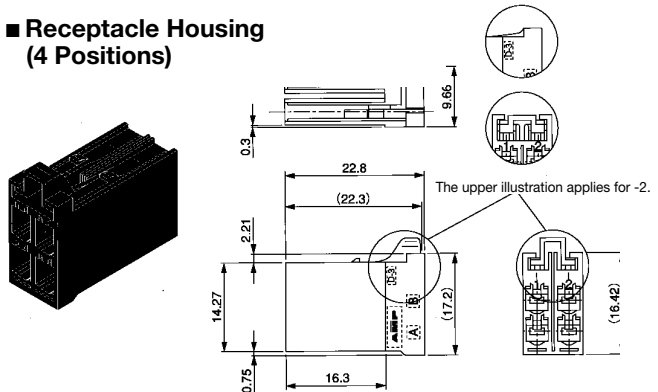

No. of Pos.	Part Number
2	175362-1
	175362-2

The illustrations show -1 type. (-2 type does not have the locking lever.)

No. of Pos.	Part Number
4	175363-1
	175363-2

*-2 type has no locking lever in order not to hinder the adjacent receptacle when removing the receptacle. When removing -2 type receptacle, please use something like a screwdriver.

■ **Tab Housing**

Panel Type

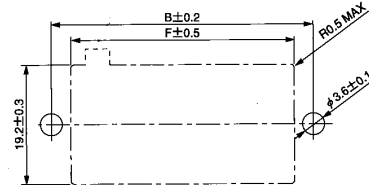
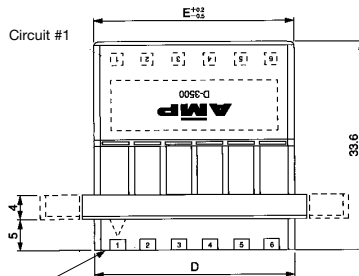
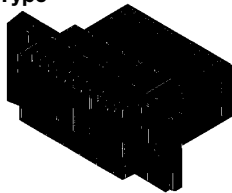

Panel Cutout

When mounting panel from the front, apply clamping torque of less than 49N [11 lbf].

Free-Hanging Type

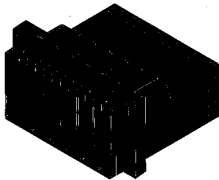

The location of mark of 3-type.

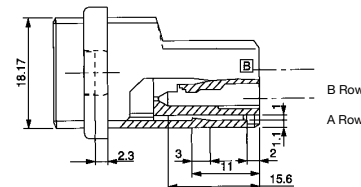
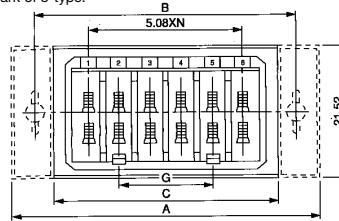

No. of Pos.	Part Number		Dimensions						
	Panel Type	Free-Hanging Type	A	B	C	D	E	F	G
12	917241-6	917242-6	52	43	36.43	32.48	32.48	33.4	15.24
	3-917241-6	3-917242-6							
20	917241-8	917242-8	72	63	56.75	52.8	52.8	53.8	35.56
	3-917241-8	3-917242-8							

*-3- type has mark on top of the circuit No.1 in order to enhance visibility.

D-3000 Series (Continued)

D-3500D — Sensor Connectors (Continued)

■ **Board-mounting Tab Header (Horizontal Type)**

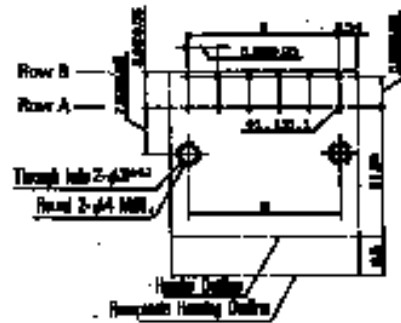
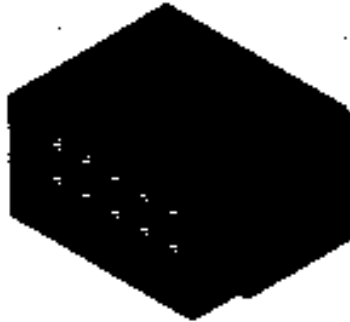

PC Board Layout
Acceptable Board Thickness:
1.6-2.4±0.1

Solder tine section is 0.64 sq.

No. of Pos.	Part Number	Dimensions	
		A	B
4	1376133-□	12.16	5.08
12	177555-□	32.48	25.4
20	175365-□	52.8	45.72

■ **Board-mounting Tab Header (Vertical Type)**

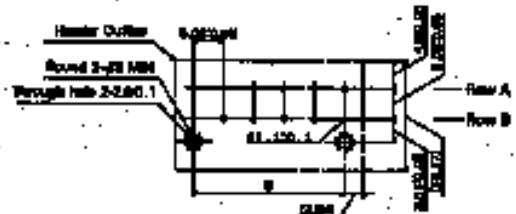
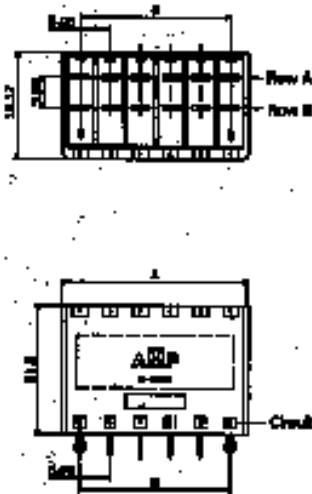

PC Board Layout
Acceptable Board Thickness:
1.6-2.4±0.1

Solder tine section is 0.64 sq.

No. of Pos.	Part Number	Dimensions	
		A	B
12	316516-□	32.48	25.4
20	316517-□	52.8	45.72

Tube Package Dimensions (Ref.)



D-3000 Series (Continued)

D-3700 — Connectors for Exclusive Use with Servomotor

Appearance Dielectric Withstanding Voltage: 1,500V (for one minute)
Voltage Rating: 250V AC

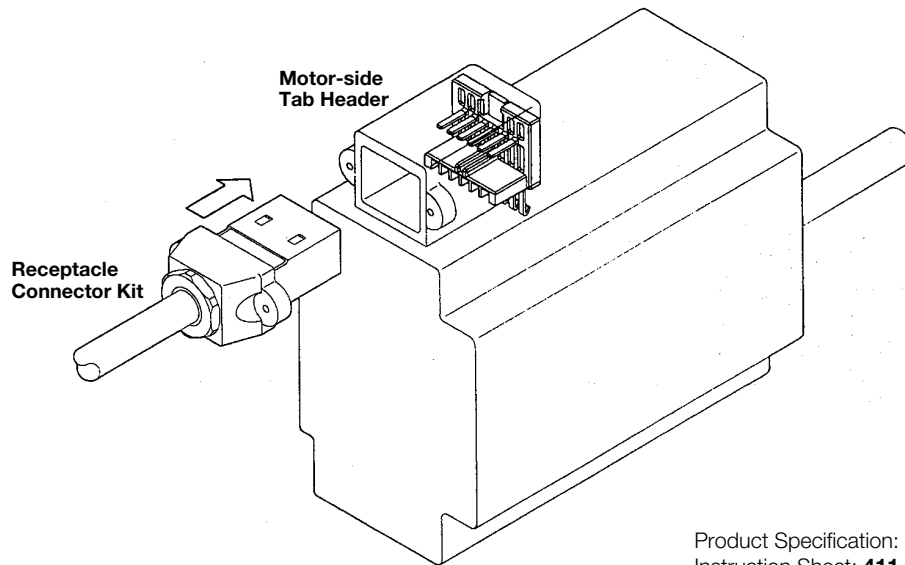

Product Specification: **108-5324**
Instruction Sheet: **411-5747**

Receptacle Connector Kit

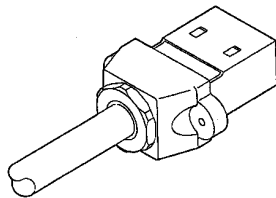

Part Number Chart

No. of Pos.	W/O Contact	Contact (P/N 1-175218-2) including 6 contacts	Remarks
6	176346-7	176346-8	Products with TÜV
	1-176346-7	1-176346-8	—

Applications

Typical Application on Servomotor / Servodriver

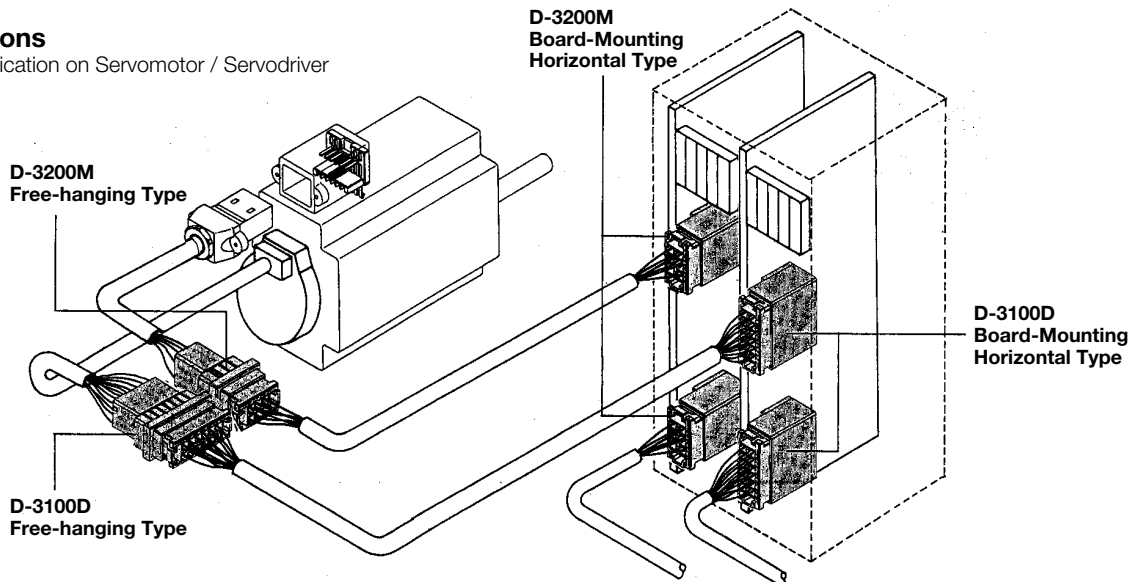

D-3000 Series (Continued)

D-3700 — Connectors for Exclusive Use with Servomotor (Continued)

Mating Dimensions

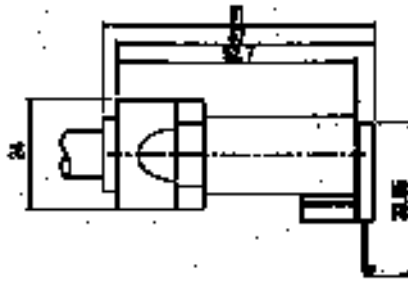

External Dimensions

■ **Receptacle Connector Kit**
(Products with CE mark)

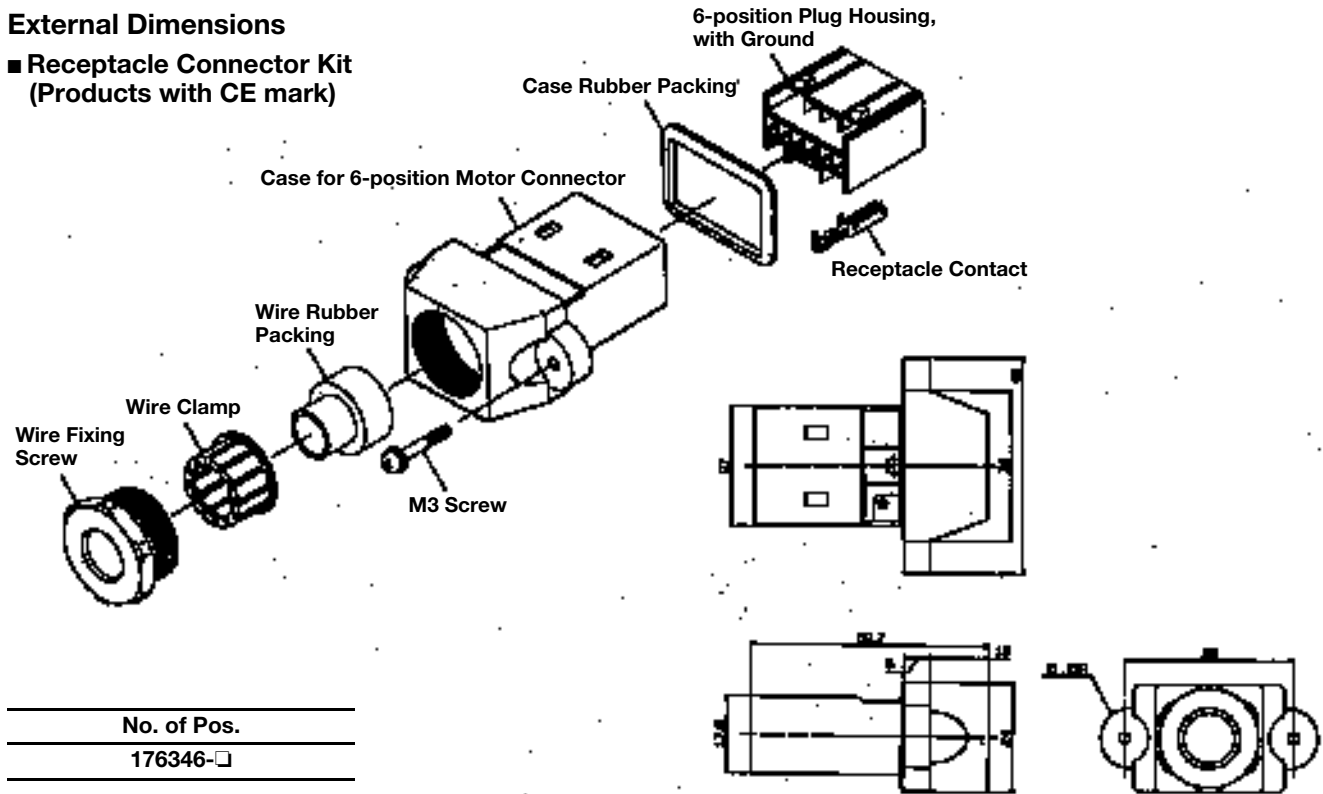

No. of Pos.
176346-□

■ **Motor-side Tab Header**
(Offered for limited usage)

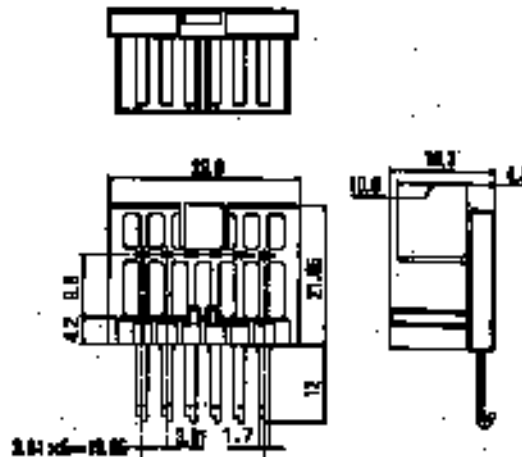
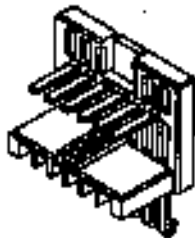

D-5200 Series

List of Products by Application

D-5200S

High-Pressure
1-Row Type

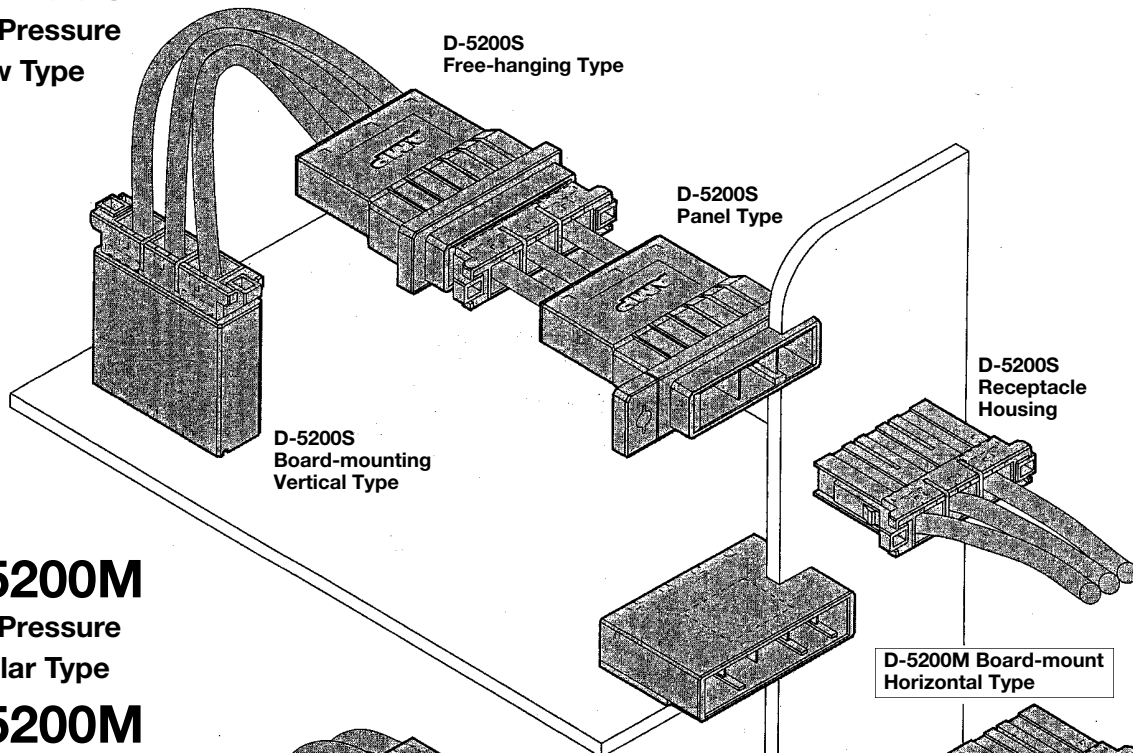

D-5200M

High-Pressure
Modular Type

D-5200M

High Current Type
(See page 77)

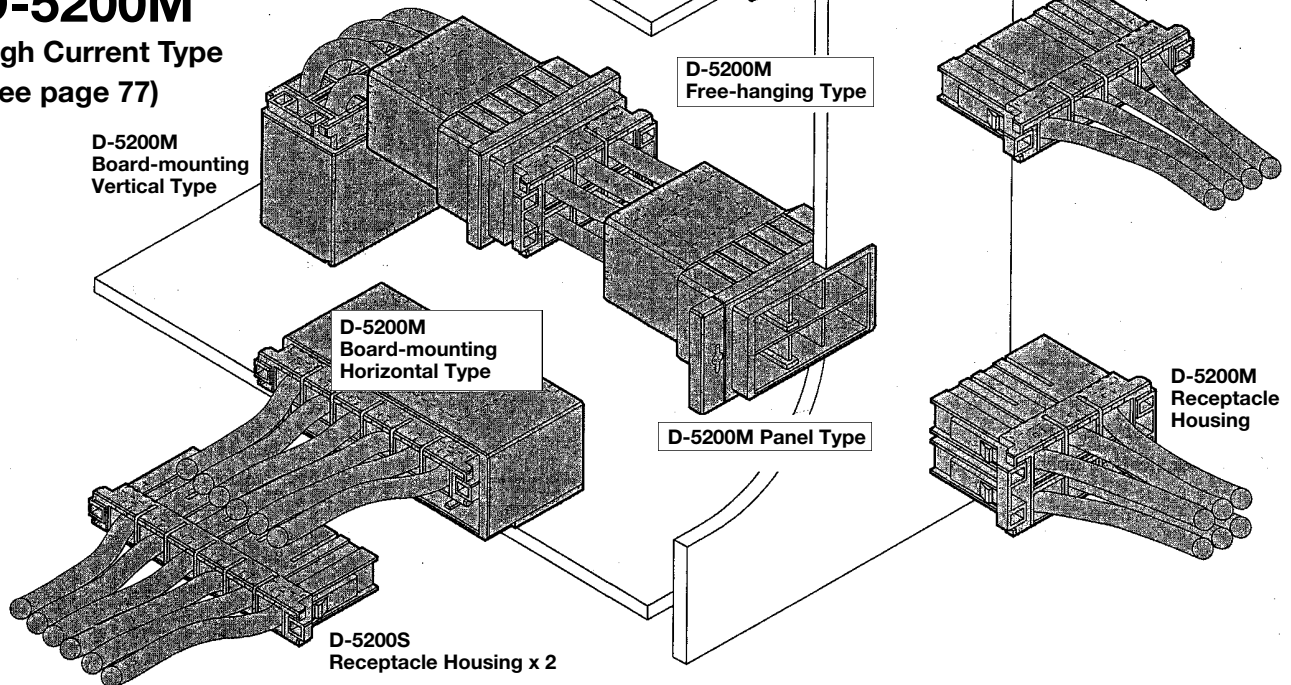

D-5200 Series (Continued)

Performance Data and Specifications

■ **D-5200S/M Performance Data**

Pitch	400mils (10.16mm)				
Description					
Voltage Rating	630V AC				
Current Rating	Wire	AWG			
		#16	#14	#12	#10
	Current	16A	19A	25A	30A
6 position max.					
Contact Resistance	2m Max.				
Dielectric Withstanding Voltage	3,000V AC (1 minute)				
Operating Temperature	-55°~+105°C				

Material and Finish

Description	Material	Finish
Receptacle Contact Tab Contact	Copper alloy	Gold plating with underplated nickel (1.27µm)
Tab Post	Copper alloy	Gold plating with underplated nickel (1.27µm)
Housing	UL 94V-0 rated, glassfiber reinforced polyester (PBT)	

■ **D-5200M Performance Data**

Pitch	400mils (10.16mm)							
Description								
Voltage Rating	630V AC							
Current Rating	Current for 3-pos. silver-plated contacts							
	Wire	AWG						
		#20	#18	#16	#14	#12	#10	#8
Current	12A	16A	20A	25A	33A	38A	45A	
Current for 4-pos. silver-plated contacts								
Wire	AWG							
	#20	#18	#16	#14	#12	#10	#8	
Current	12A	15A	18A	23A	31A	35A	43A	
Contact Resistance	2m Max.							
Dielectric Withstanding Voltage	3,000V AC (1 minute)							
Operating Temperature	-55°~+105°C							

Material and Finish

Description	Material	Finish
Receptacle Contact Tab Contact	Copper alloy	Silver plating with underplated nickel (2.54µm)
Tab Post	Copper alloy	Silver plating with underplated nickel (2.54µm)
Housing	UL 94V-0 rated, glassfiber reinforced polyester (PBT)	

D-5200 Series (Continued)

■ **Crimp Type Contacts**

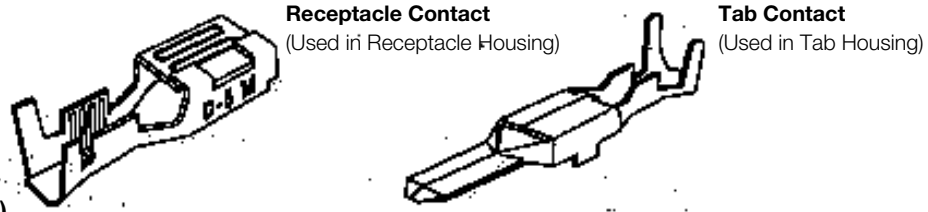

D-5 Contacts (Gold Plating)

Wire Range		Ins. Dia. Range mm	Wire Range Mark	Contact Part Numbers*		Sequential Tab	Application Tooling		
AWG	mm ²			Receptacle	Tab		Mini-Applicator	Hand Tool	
16	1.25	3~3.8	S	ST.	179955-□	917802-□	84696-1	**	—
14	2.20			LP.	316040-□	917804-□	—	—	234170-1
12	3.50	4~5.2	M	ST.	179956-□	917803-□	84695-1	**	—
10	5.50			LP.	316041-□	917805-□	—	—	234171-1

Note: Enter the following plating code in Part Number suffix-□:
 -2 = 0.38µm thick gold plating
 -3 = 0.76µm thick gold plating

* Strip Form contacts are used with Mini-Applicator and Loose-Piece contacts are with hand tools.

**Mini-Applicator is for use on Automachines. (See page 68. Contact Technical Support for details.)

D-5 Contacts (Silver Plating)

Wire Range		Ins. Dia. Range mm	Wire Range Mark	Contact Part Numbers*		Application Tooling	
AWG	mm ²			Receptacle	Tab	Mini-Applicator	Hand Tool
20	0.50	1.8~3.23	SS	ST.	1318985-6	**	—
16	1.25			LP.	1318986-6	—	91596-1
16	1.25	3~3.80	S	ST.	179955-6	**	—
14	2.20			LP.	316040-6	—	234170-1
12	3.50	4~5.2	M	ST.	179956-6	**	—
10	5.50			LP.	316041-6	—	234171-1
8	8.00	4.9~7.8	L	ST.	1318696-6	**	—
				LP.	1318697-6	—	1366044-1

Note: The contacts part numbered with "-6" are silver plated with 2.54 µm thickness.

* Strip Form contacts are used with Mini-Applicator and Loose-Piece contacts are with hand tools.

**Mini-Applicator is for use on Automachines. (See page 68. Contact Technical Support for details.)

Application Tooling

■ **Extraction Tool**
Part Number: 409158-1
 Instruction Sheet 411-5774

- Used to extract contacts from wire type tab / receptacle housing. (Take care when inserting tool as the lance section of D-5 is turned upside down to that of D-3.)
- With D-5 contacts only, it is possible to extract using a small-size slotted screwdriver.

• **How to Use Extraction Tool**



- ① Insert Extraction Tool in the direction as shown, insert into the narrow lower section of Housing's reverse convex hole. (make sure that you are holding tool in proper position, top and bottom.)
- * Take care not to insert tool into contact section. If you've inserted by error, replace the contact with a new one before proceeding.

When Using D-5 Extraction Tool



② The tip of Extraction Tool depresses housing lance, letting contact free.



③ Contact can now be pulled out.

When Using Slotted Screwdriver



② When you butt the tip of tool at lance section and depress it, contact is released free.



③ Contact can be pulled out.

D-5200 Series (Continued)

Application Tooling

(Continued)

■ AMP-3K/40 and AMP-5K/40 Terminating Machines

The AMP-3K/40 and AMP-5K/40 Terminators are designed for customers that require the increased output and quality of a semi-automatic machine at a competitive price. By incorporating the most commonly requested features as standard and offering a long list of optional equipment, these terminators offer flexibility to meet the specific needs of various applications at the lowest possible cost.

- 3,000 lb. [1361 kg] max. crimp force (AMP-3K/40)
- 5,000 lb. [2268 kg] max. crimp force (AMP-5K/40)
- Toolless removal of applicators and guards
- Jog capability
- Quiet, fast operation — 80/76 dBA and cycle time less than 0.400 seconds
- Accepts Heavy Duty Mini style applicators
- Wide range of optional equipment such as toolless precision crimp height adjust, batch counter, CQM capability and work light
- Order Catalog 1654856 for specifications and part numbers

■ Hand Tool

The crimping section incorporates Straight Action construction for improved reliability as with automachine.

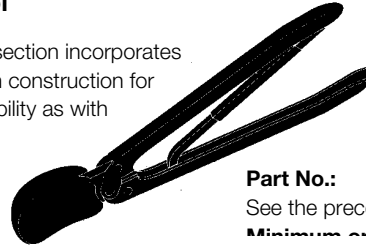

Part No.:

See the preceding page.

Minimum order quantity: 1



Technical Support

■ AMP-O-LECTRIC Model G Terminating Machine

The Model "G" Terminator is the most advanced design in the long-standing series of AMP-O-LECTRIC machines for terminating wire using reeled terminals and contacts. It features a reliable direct motor drive system. Its modular construction enables it to be used either as a bench-top unit, or in combination with fully-automatic lead-making equipment. For operator convenience, access to and lighting in the target area has been improved and the Crimp Quality Monitor (CQM) has been moved to eye level for bench-top use. The Model "G" is also quieter, plus improved guarding meets applicable European and domestic safety requirements.

- Quieter
- Improved guarding and lighting
- Toolless changeover of applicators
- Precision manual- or auto-adjust for crimp height
- Total and batch counter
- Accepts all existing Tyco Electronics miniature applicators, with minor modifications
- Reduced maintenance requirements
- Request Catalog 65828 for specifications and part numbers



Mini-Applicator

Part Number: Contact Technical Support.

Minimum order quantity: 1

Mounting Hardware

Attachment

■ Sequential Clip

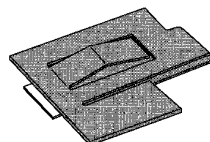

Part Number: 179993-1

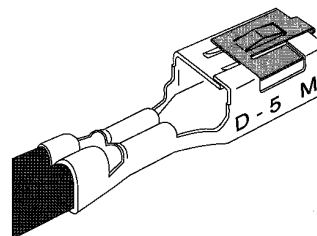

D-5200 Series (Continued)

D-5200S — Standard 1-Row Type

Appearance Board mounting pitch: 400mils (10.16mm)
Dielectric Withstanding Voltage: 3,000V (for one minute)
Voltage Rating: 630V AC

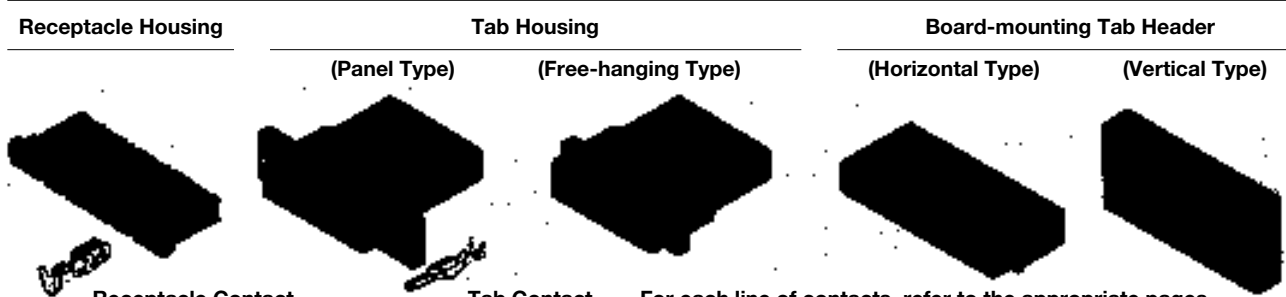
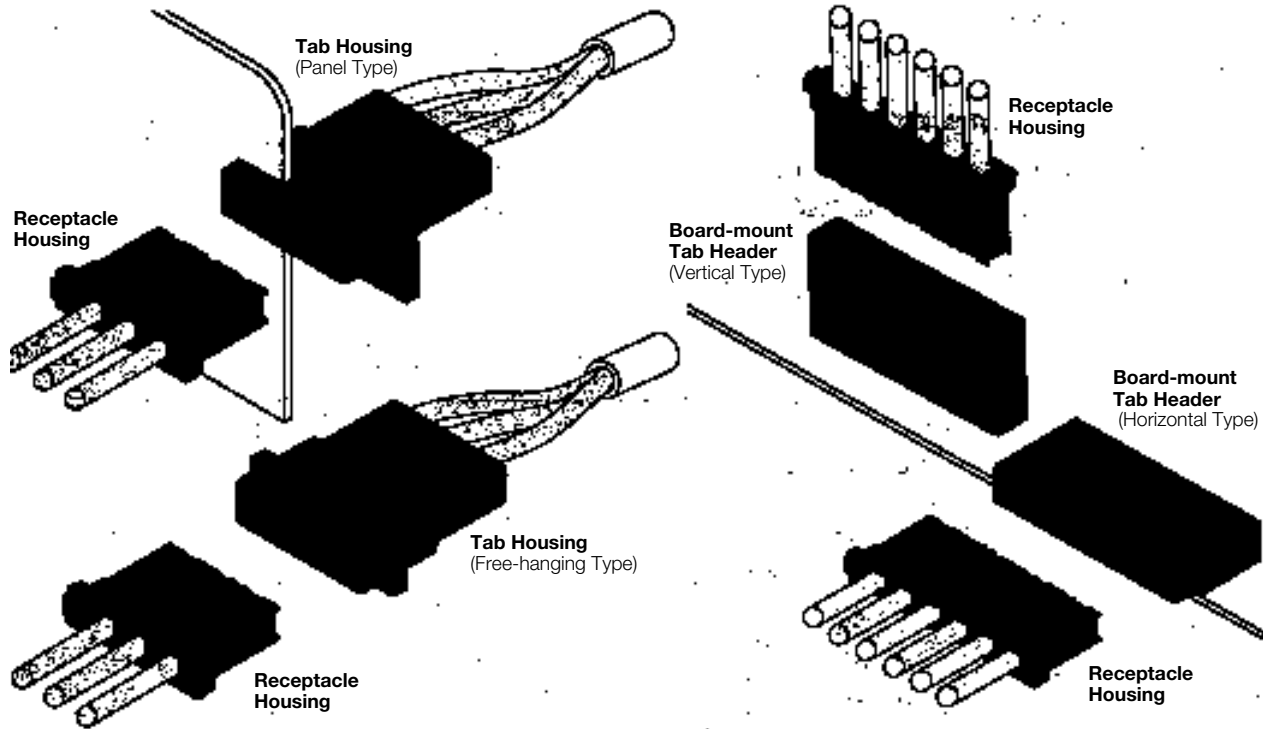

Receptacle Contact

Tab Contact.....For each line of contacts, refer to the appropriate pages.

No. of Pos.	Keying	Part Number of Receptacle Housings	Part Number of Tab Housings		Part Number Board-mounting Tab Headers	
			Panel Type	Free-hanging Type	Horizontal Type	Vertical Type
2	X	1-179958-2	1-353047-2	1-353046-2	1-353079-□	1-353080-□
	Y	2-179958-2	2-353047-2	2-353046-2	2-353079-□	2-353080-□
3	X	1-179958-3	1-353047-3	1-353046-3	1-353081-□	1-353082-□
	Y	2-179958-3	2-353047-3	2-353046-3	2-353081-□	2-353082-□
4	X	1-179958-4	Use low 4- and 6-position D-5200MS, 4- and 6-position Panel and Free-hanging Types.		1-917541-□	1-917542-□
	Y	2-179958-4			2-917541-□	2-917542-□
5	X	—			—	—
	Y	—			—	—
6	X	1-179958-6	1-179959-□	1-179960-□		
	Y	2-179958-6	2-179959-□	2-179960-□		

Note: Enter the following plating code in Part Number suffix-□
-2 = 0.38µm thick gold plating
-3 = 0.78µm thick gold plating

D-5200 Series (Continued)

**D-5200S — Standard
1-Row Type** (Continued)

Mating Dimensions



Panel / Free-hanging Type

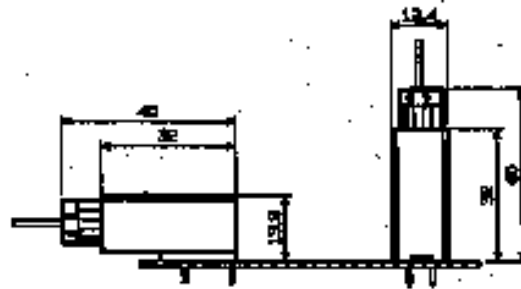

Horizontal / Vertical Type

■ **External Dimensions
Receptacle Housing**

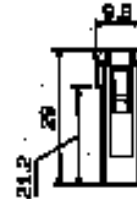
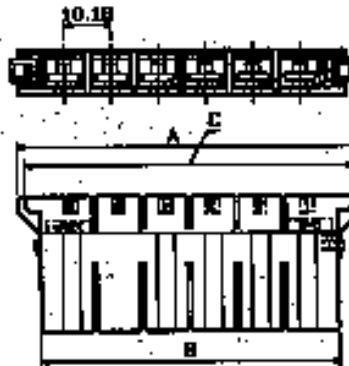

No. of Positions	Part Number of Receptacle Housing	Dimensions	
		A	B
2	□-179958-2	35.76	23.76
3	□-179958-3	45.92	33.92
4	□-179958-4	53.68	44.08
5	—	—	—
6	□-179958-6	74.00	64.40

■ **Tab Housing**

Panel Type

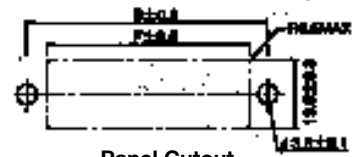
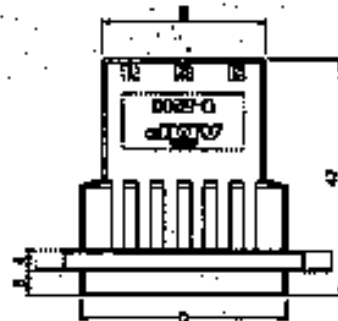
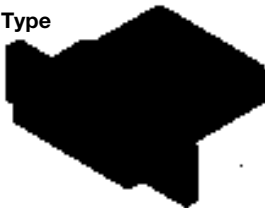

Panel Cutout

When mounting panel from the front, apply clamping torque of less than 49N [11 lbf].

Free-hanging Type

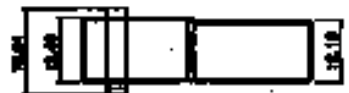
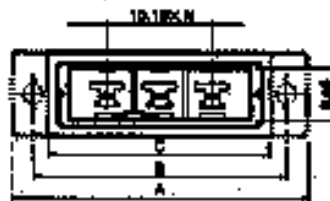

No. of Pos.	Part Number of Tab Housing		Dimensions					
	Panel Type	Free-hanging Type	A	B	C	D	E	F
2	□-353047-2	□-353046-2	47	38	33.44	29.36	21.11	30.4
3	□-353047-3	□-353046-3	57	48	43.6	39.52	31.27	40.5

D-5200 Series (Continued)

D-5200S — Standard
1-Row Type (Continued)

■ **Board-mount Tab Header (Horizontal Type)**

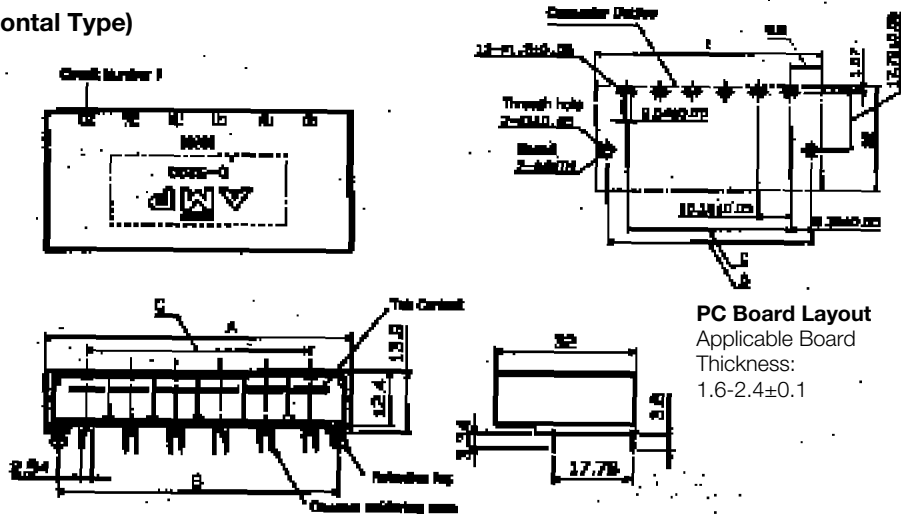
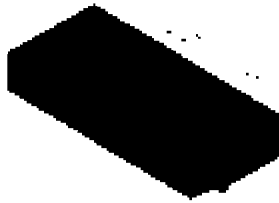

Solder tine section is 1.0 sq.

No. of Pos.	Part Number of Tab Header	Dimensions		
		A	B	C
2	□-353079-□	29.36	22.86	10.16
3	□-353081-□	39.52	33.02	20.32
4	□-917541-□	49.68	43.18	30.48
5	—	—	—	—
6	□-179959-□	70.00	63.50	50.80

Tube Package Dimensions (Ref.)



■ **Board-mount Tab Header (Vertical Type)**

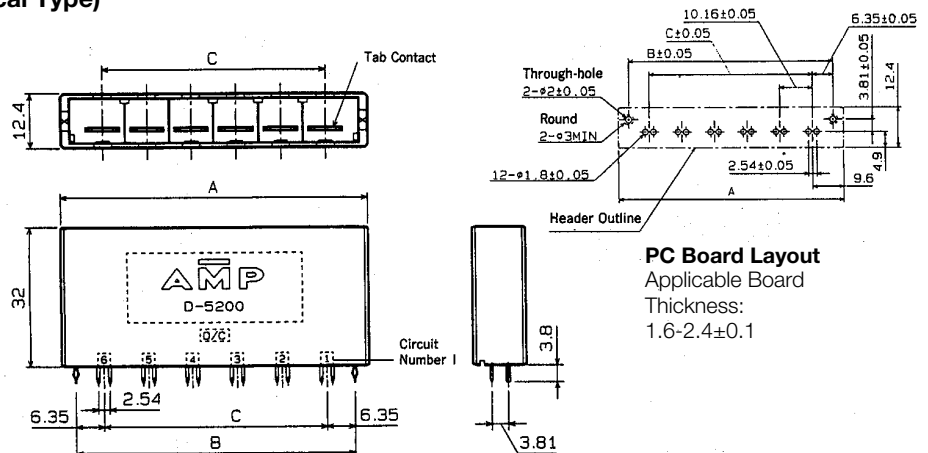
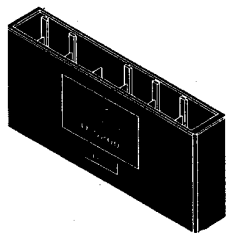

Solder tine section is 1.0 sq.

No. of Pos.	Part Number of Tab Header	Dimensions		
		A	B	C
2	□-353080-□	29.36	22.86	10.16
3	□-353082-□	39.52	33.02	20.32
4	□-917542-□	49.68	43.18	30.48
5	—	—	—	—
6	□-179960-□	70.00	63.50	50.80

Tube Package Dimensions (Ref.)

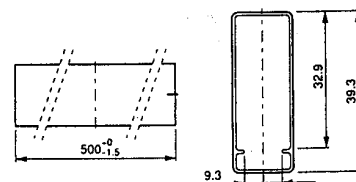

D-5200 Series (Continued)

D-5200M — Modular Type

D-5200M—Can be used for modular application in conjunction with D-5200S. Also used for power distribution.

Board mounting pitch: 400x400mils (10.16x10.16mm)
 Dielectric Withstanding Voltage: 3,000V (for one minute)
 Voltage Rating: 630V AC (when one connector is used)

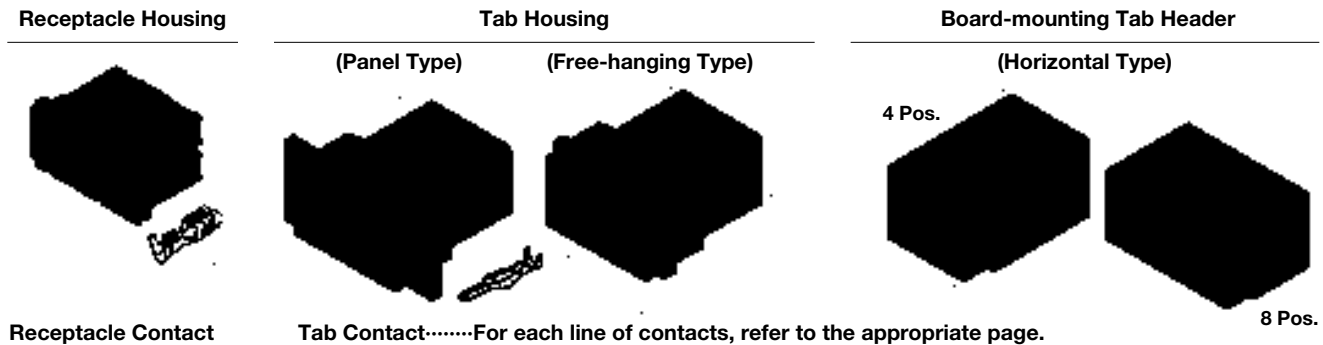
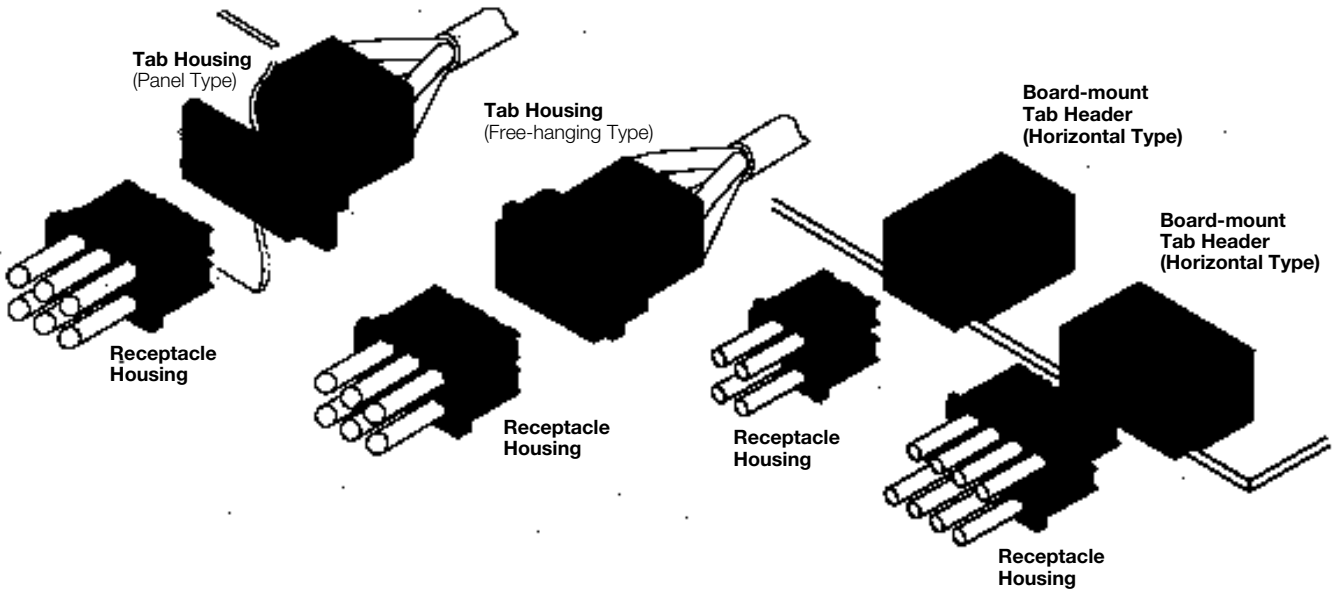

Receptacle Contact Tab Contact.....For each line of contacts, refer to the appropriate page.

No. of Pos.	Keying	Part Number of Receptacle Housings	Part Number of Tab Housing		Board-mounting Tab Header
			Panel Type	Free-hanging Type	Horizontal Type
4	XX	1-917807-2	1-917809-2	1-917808-2	1-1123309-□
	YY	2-917807-2	2-917809-2	2-917808-2	2-1123309-□
	XY	3-917807-2	3-917809-2	3-917808-2	3-1123309-□
6	XX	1-917807-3	1-917809-3	1-917808-3	—
	YY	2-917807-3	2-917809-3	2-917808-3	—
	XY	3-917807-3	3-917809-3	3-917808-3	—
8	XX	—	—	—	1-1123829-1

Note: Enter the following plating code in Part Number suffix-□ :
 -2 = 0.38µm thick gold plating
 -3 = 0.76µm thick gold plating

D-5200 Series (Continued)

D-5200M — Modular Type

(Continued)

■ **Keying**

Keying is provided with this product (D-5200M) to help prevent misinsertion. Three types, XX, YY, and XY, are available. (Shown below is the mated interface of Tab Header.)

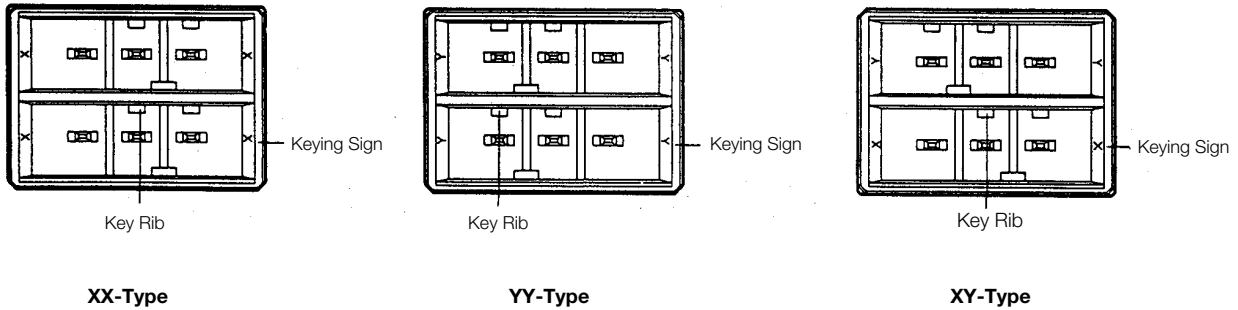





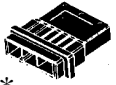

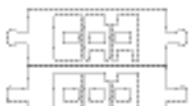

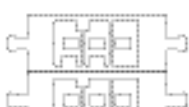

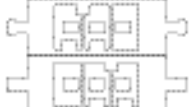



Table of Mating Combinations

Receptacle Housing		Tab Housing		Board-mount Tab Header	
1 Row (D-5200S) 	X-Type		1 Row (D-5200S) Panel Type X-Type Panel Type 	1 Row (D-5200S) Horizontal Type X-Type Horizontal Type 	Vertical Type
	Y-Type		Free-hanging Type Y-Type Panel Type 	Vertical Type Y-Type Horizontal Type 	Vertical Type
2 Row 	XX-Type		2 Rows Panel Type XX-Type Panel Type Free-hanging Type 	2 Rows Horizontal Type XX-Type Horizontal Type Vertical Type	Vertical Type
	YY-Type		Free-hanging Type YY-Type Panel Type Free-hanging Type 	Vertical Type YY-Type Horizontal Type Vertical Type	Vertical Type
	XY-Type		Free-hanging Type XY-Type Panel Type Free-hanging Type 	Vertical Type XY-Type Horizontal Type Vertical Type	Vertical Type

*D-5200S Series

D-5200 Series (Continued)

D-5200M — Modular Type

(Continued)

Mating Dimensions

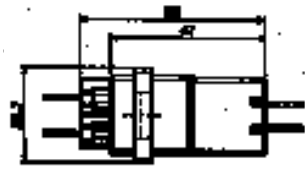

Panel / Free-hanging Type

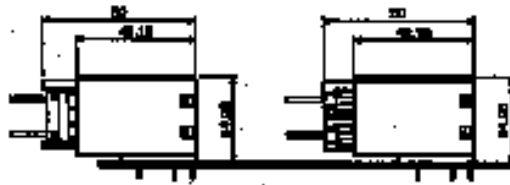

Horizontal Type (When used as modular unit)

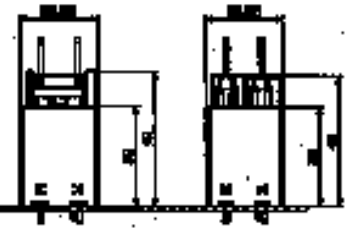

Vertical Type (When used as modular unit)

External Dimensions

■ Receptacle Housing

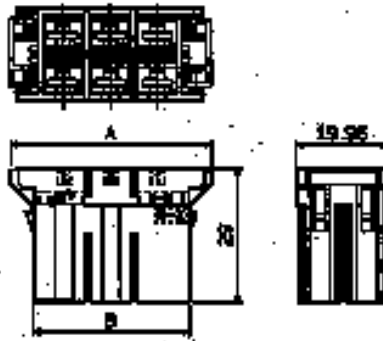

No. of Positions	Part Number of Receptacle Housing	Dimensions	
		A	B
4	□-917807-2	33.36	23.76
6	□-917807-3	43.52	33.92

■ Tab Housing

Panel Type

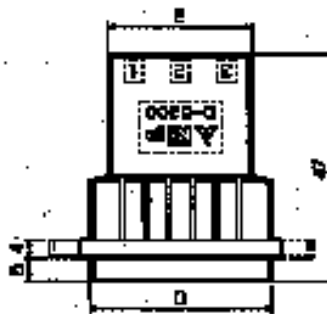
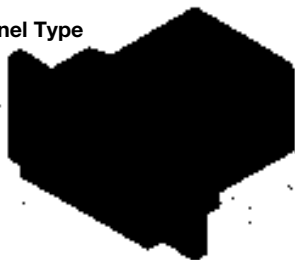

Panel Cutout

When mounting panel from the front, apply clamping torque of less than 49N [11 lbf].

Free-hanging Type

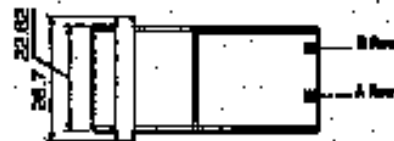
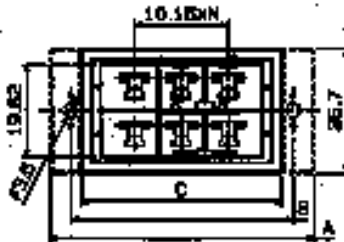
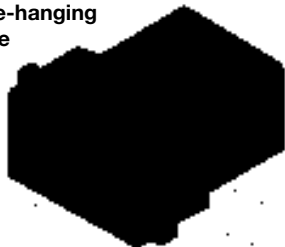

No. of Pos.	Part Number of Tab Housing		Dimensions					
	Panel Type	Free-hanging Type	A	B	C	D	E	F
4	□-917809-2	□-917808-2	47	38	33.44	29.36	21.11	30.40
6	□-917809-3	□-917808-3	57	48	43.60	39.52	31.27	40.50

D-5200 Series (Continued)

D-5200M — Modular Type

(Continued)

■ **Board-mount Tab Header (Horizontal Type)**

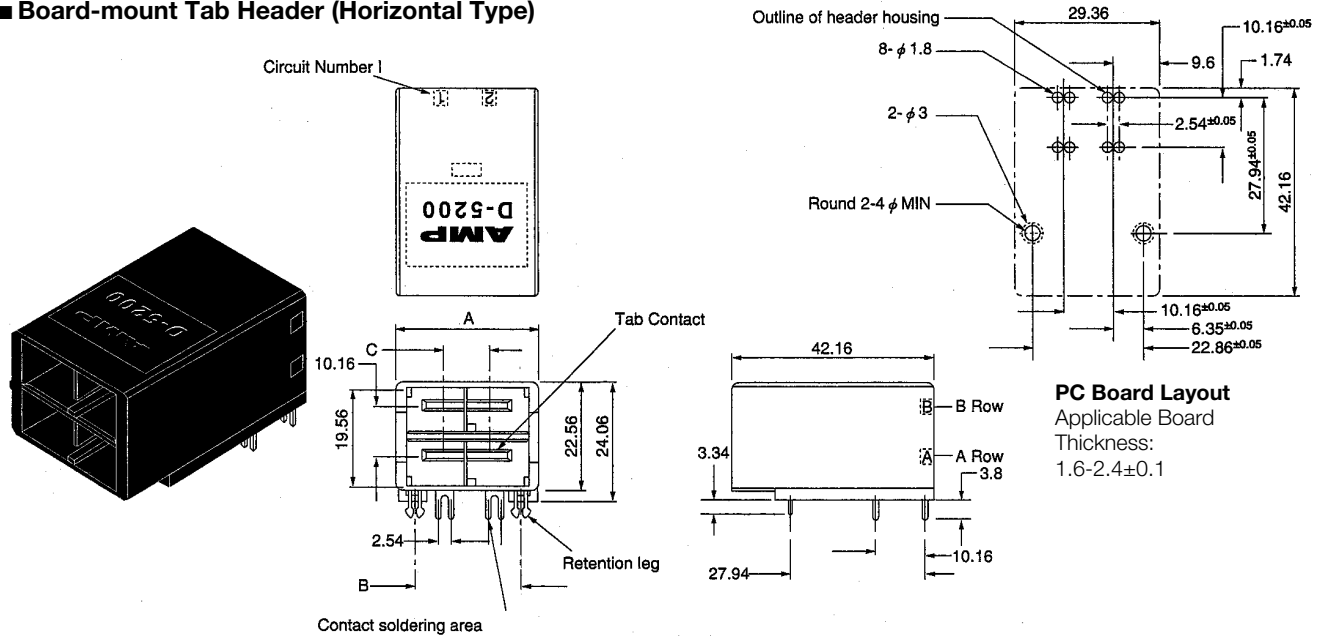

Solder tine section is 1.0 sq.

No. of Pos.	Part Number of Tab Header	Dimensions		
		A	B	C
4	□-1123309-□	29.36	22.86	10.16

■ **Board-mount Tab Header (Horizontal Type)**

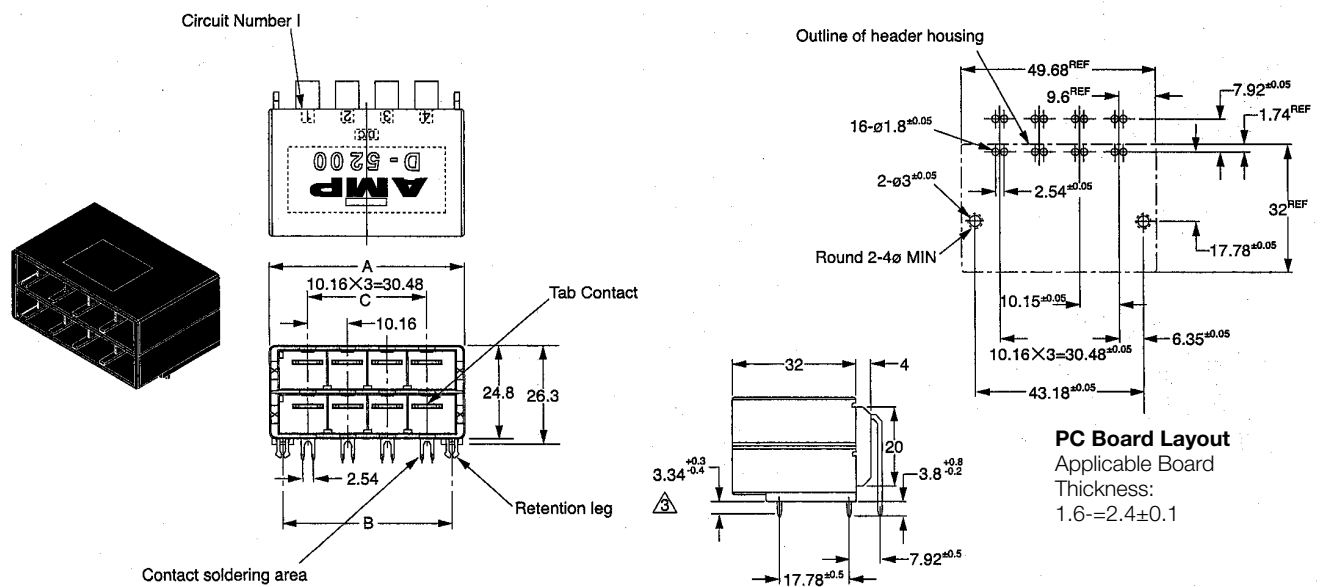

Solder tine section is 1.0 sq.

No. of Pos.	Part Number of Tab Header	Dimensions		
		A	B	C
8	1123829-1	49.68	43.18	30.48

D-5200 Series (Continued)

D-5200M — High Current Type

Appearance Board mounting pitch: 400mils (10.16mm)
Dielectric Withstanding Voltage: 3,000V (for one minute)
Voltage Rating: 630V AC

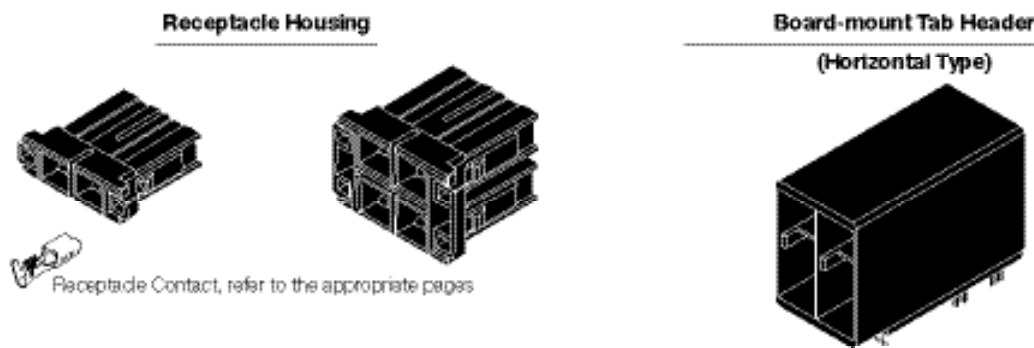
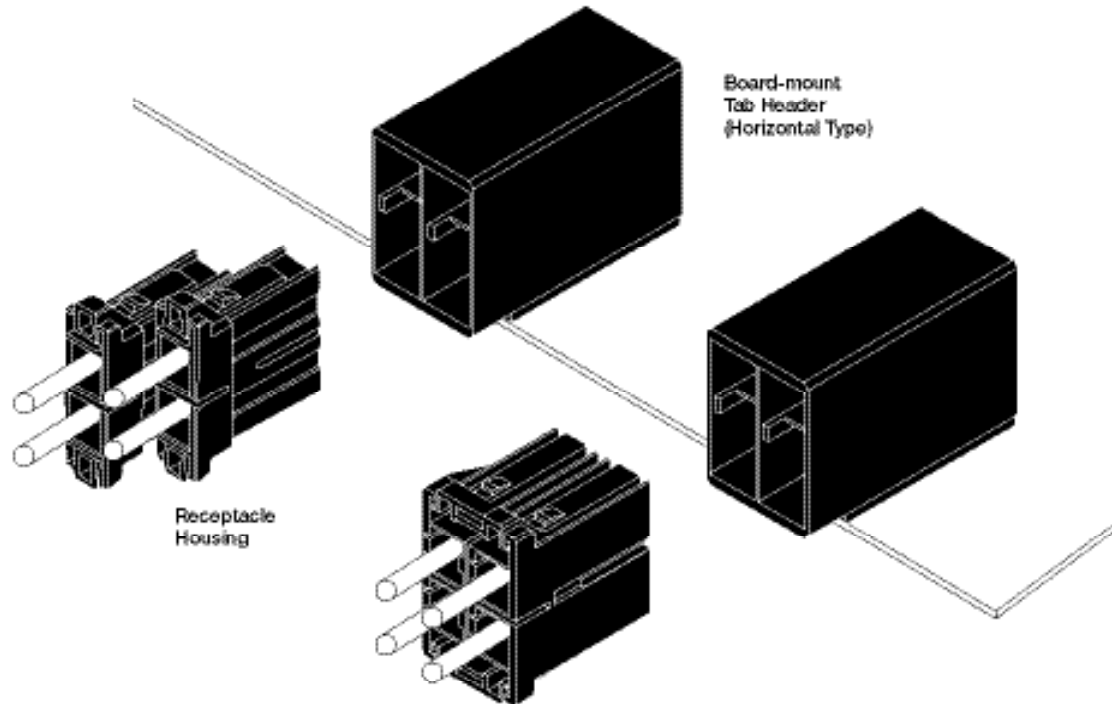

Part Number Chart

No. of Pos.	Keying	Part Number of Receptacle Housings	Part Number of Board-mounting Tab Headers Horizontal Type
2	X	1-179958-2	—
	Y	2-179958-2	—
4	XX	1-917807-2	1-1318983-6
	YY	2-917807-2	2-1318983-6
	XY	3-917807-2	3-1318983-6

* The 2 pos. receptacles use same 2 pos. housing of D-5200S series.
The 4 pos. receptacles use same 4 pos. housing of D-5200M series.
The contacts, however, are D-5 (Silver plated type) on page 67.

■ Keying

Keying is provided with this product (D-5200M) to help prevent misinsertion. Three types, XX, YY, and XY, are available.

D-5200 Series (Continued)

D-5200M — High Current Type (Continued)

Mating Dimensions

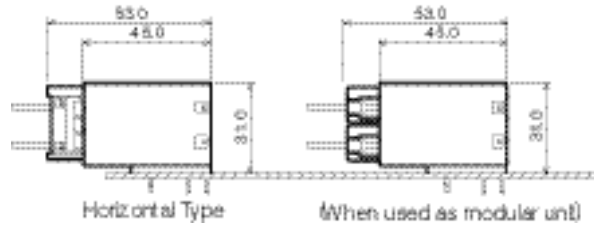

External Dimensions

■ Receptacle Housing (2 Pos.)

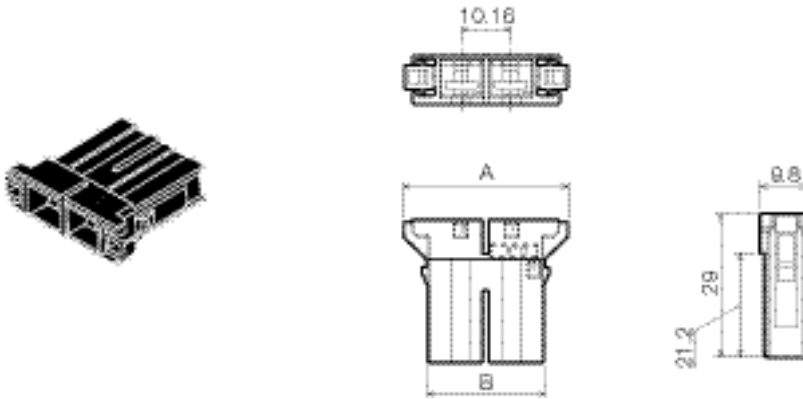

No. of Positions	Keying	Part Number of Receptacle Housing	Dimensions	
			A	B
2	X	1-179958-2	35.76	23.76
	Y	2-179958-2		

■ Receptacle Housing (4 Pos.)

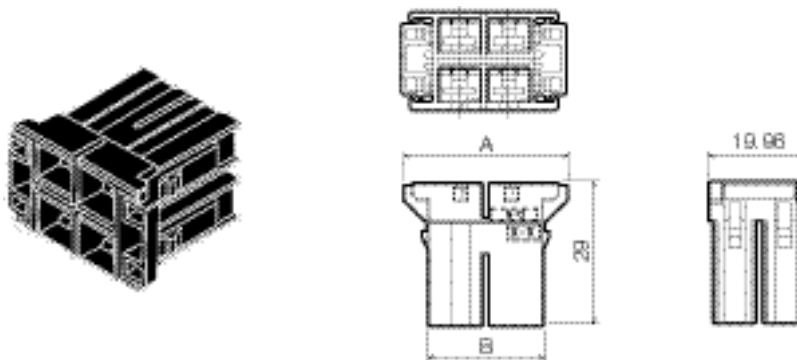

No. of Positions	Keying	Part Number of Receptacle Housing	Dimensions	
			A	B
4	XX	1-917807-2	33.36	23.76
	YY	2-917807-2		
	XY	3-917807-2		

D-5200 Series (Continued)

D-5200M — High Current Type (Continued)

■ **Board-mount Tab Header (Horizontal Type)**

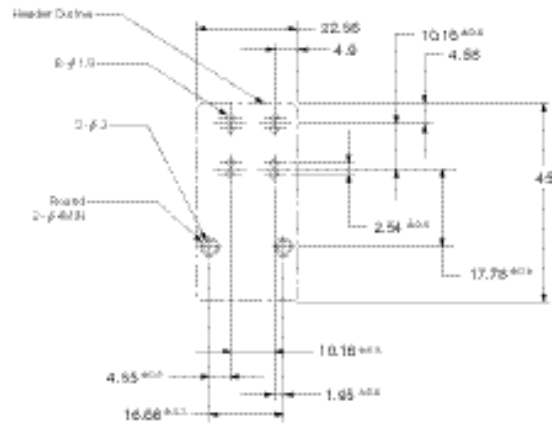
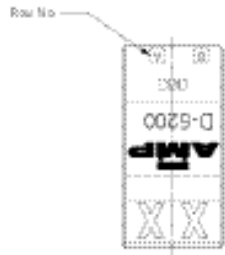
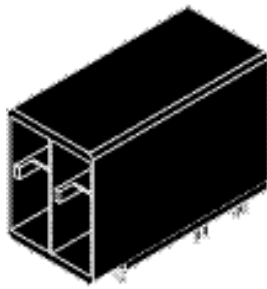

PC Board Layout
Applicable Board
Thickness: 1.6~2.4±0.1

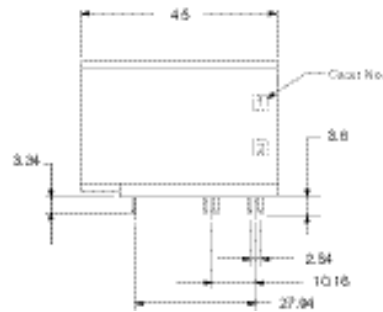
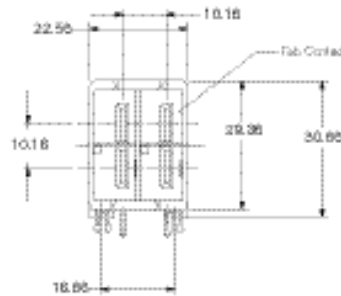

No. of Positions	Keying	Part Number of Receptacle Housing
4	XX	1-1318983-6
	YY	2-1318983-6
	XY	3-1318983-6

Power Connector for Board-to-Board Application

Can be used for tab contact connection.
Besides, board can be directly inserted into this connector.

Material & Finish	Housing: Glass-filled thermoplastic, blue Contact: Coper alloy, plated gold (1.27 µm thick) on contact area and tin on post area Tab Contact: Brass, 1.27 µm plated gold
Current Rating	20A
Operating Temperature	-55°C ~ +85°C
Insertions and Extractions	30 times

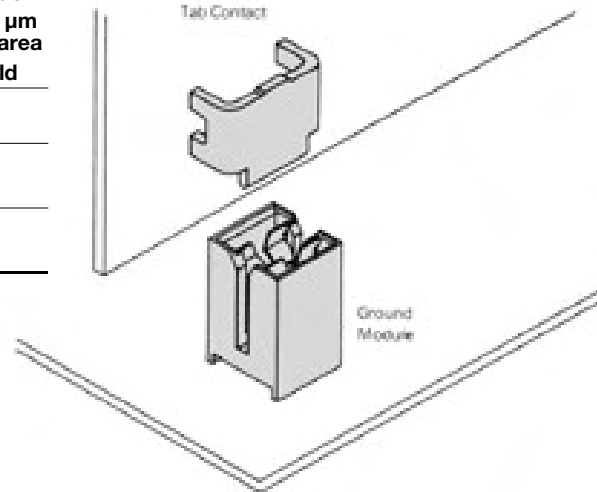

Ground Module

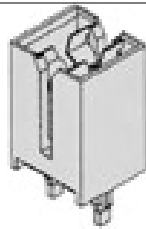

Part Number
119341-1

Tab Contact

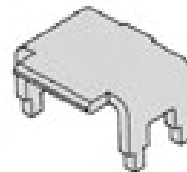

Part Number
175145-2

Application

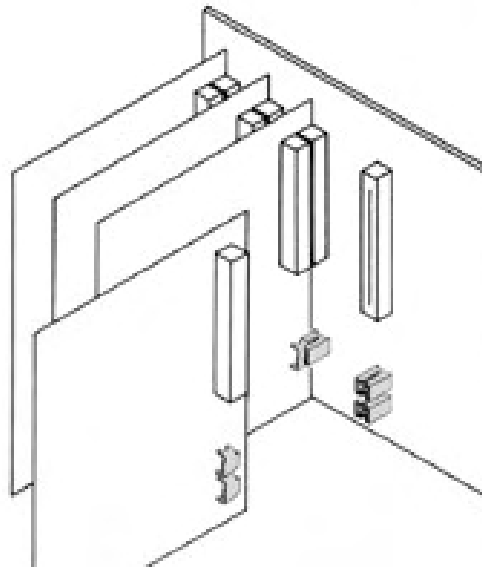

Power Connector for Board-to-Board Application (Continued)

Mating Dimensions

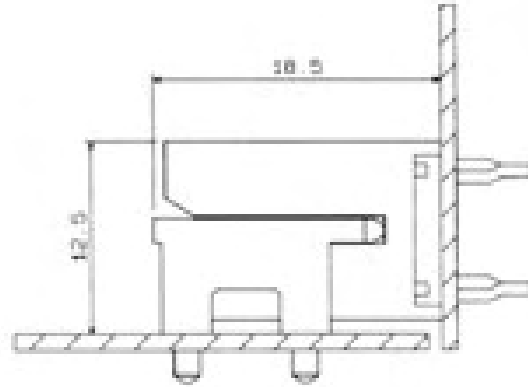

External Dimensions

■ **Ground Module**

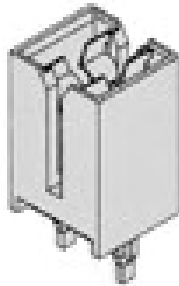

Part Number
119341-1

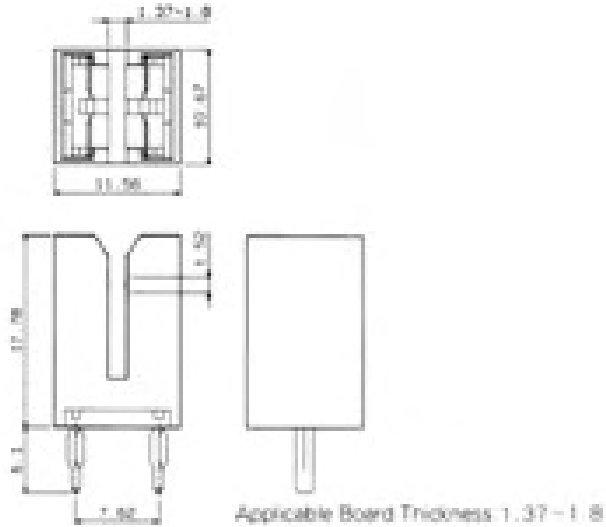

■ **Tab Contact**

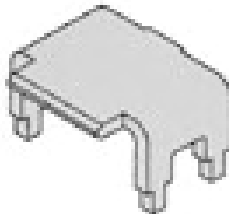

Part Number
175145-2

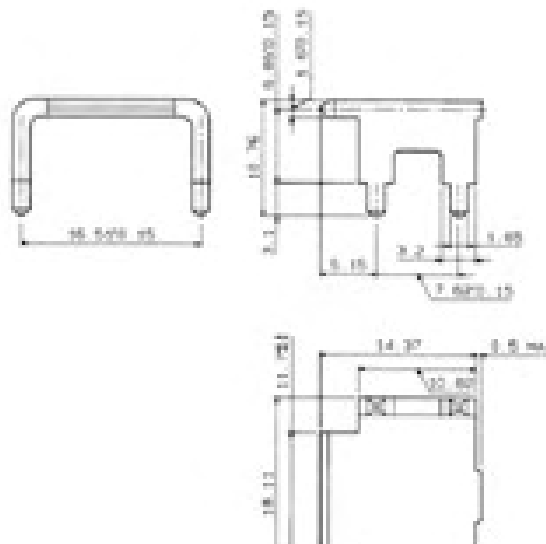

Part Number Index

Note: This numerical index lists all cataloged parts by base no. only. Complete part nos. (with prefixes and/or suffixes) are shown on the page(s) indicated.

Part No.	Page No.
84695	67
84696	67
119341	80, 81
175145	80, 81
175194	24
175195	24
175196	24
175216	24
175217	24
175218	24
175284	24
175285	24
175286	24
175287	24
175288	24
175289	24
175362	59, 60
175363	59, 60
175365	59, 61
176346	62, 63
177555	59, 61
177648	29, 31
177662	33, 34
177665	33, 34
178127	38, 39, 40
178128	42, 44, 46
178129	48, 50
178136	42, 45
178137	38, 39, 41
178138	42, 45
178139	48, 51, 52, 54
178140	48, 51, 52, 54
178141	38, 39, 41
178214	56, 57
178216	56, 58
178288	29, 31, 33, 39
178289	35, 36
178293	29, 32, 39
178294	29, 32

Part No.	Page No.
178295	29, 32
178296	29, 32
178297	29, 32
178298	29, 32
178303	35, 37
178305	35, 37
178306	35, 37
178307	35, 37
178308	35, 37
178313	29, 32, 39
178314	29, 32
178315	29, 32
178316	29, 32
178317	29, 32
178318	29, 32
178323	35, 37
178325	35, 37
178326	35, 37
178327	35, 37
178328	35, 37
178802	29, 31
178803	35, 36
178964	35, 36
179188	33, 34
179276	42, 45
179277	42, 45
179552	42, 44
179553	42, 44
179554	48, 50, 52, 53
179555	48, 50, 52, 53
179955	67
179956	67
179958	69, 71, 77, 78
179959	69, 72
179960	69, 72
179993	68
316040	67
316041	67
316080	48, 51
316081	48, 51
316130	42, 45
316131	42, 45
316132	42, 45

Part No.	Page No.
316133	42, 45
316516	59, 61
316517	59, 61
353046	69, 71
353047	69, 71
353079	69, 72
353080	69, 72
353081	69, 72
353082	69, 72
353715	24
353716	24
353717	24
353718	24
900121	28
900128	28
900167	16, 18, 52
917241	59, 60
917242	59, 60
917249	56, 57
917251	56, 58
917266	52, 53
917337	42, 45
917338	42, 45
917389	46, 47
917484	24
917485	24
917511	24
917512	24
917541	69, 72
917542	69, 72
917657	48, 51
917658	48, 51
917659	48, 50
917802	67
917803	67
917804	67
917805	67
917807	73, 75, 77, 78
917808	73, 75
917809	73, 75
1123309	73, 76
1123624	55
1123829	73, 76

Part No.	Page No.
1318105	7
1318106	7
1318107	7
1318108	7
1318109	7
1318110	7
1318111	7
1318112	7
1318114	12, 14
1318115	12, 14
1318116	8, 10
1318117	8, 10
1318118	12, 14
1318119	12, 14
1318120	8, 10
1318123	8, 11
1318124	12, 15
1318125	12, 15
1318126	12, 15
1318127	12, 15
1318577	16, 17
1318578	16, 17
1318579	16, 18
1318696	67
1318697	67
1318983	77, 79
1318985	67
1318986	67
1376009	12, 15
1376020	12, 15
1376059	16, 18
1376072	16, 19
1376073	16, 19
1376133	59, 61
1376135	8, 11
1376136	12, 15
1376137	12, 15

Application Tooling

Part No.	Page No.
58571	25
91558	24
91559	24
91560	24
91561	24
91565	24
91576	6, 7
91595	6, 7
91596	66, 67

Part No.	Page No.
175855	27
234168	27
234170	66, 67
234171	66, 67
234172	23
409158	67
919041	27
919600	23
919601	23

Part No.	Page No.
919602	23
1366044	66, 67

Americas

Argentina – Buenos Aires
Phone: +54-11-4733-2200
Fax: +54-11-4733-2250

Brasil – São Paulo
Phone: +55-11-3611-1311
Fax: +55-11-3611-0397

Canada – Markham
Phone: +905-475-6222
Fax: +905-474-5520
Product Information Center: (Technical Support)
Phone: +905-470-4425
Fax: +905-474-5525

Colombia – Bogota
Phone: +57-1-240-9396
Fax: +57-1-660-0206

Mexico – Mexico City
Phone: +52-55-5-729-0425
Fax: +52-55-5-398-1430

United States – Harrisburg, PA
Phone: +717-564-0100
Fax: +717-986-7575
Product Information Center: (Technical Support)
Phone: +800-522-6752
Fax: +717-986-7575

For Latin/South American Countries not shown
Phone: +57-1-240-9396
Fax: +57-1-660-0206

Asia/Pacific

Australia – Sydney
Phone: +61-2-9840-8200
Fax: +61-2-9899-5649
Product Information Center: (Technical Support)
Phone: +61-2-9554-2600
Fax: +61-2-9502-2556

India – Bangalore
Phone: +91-80-841-0200
Fax: +91-80-841-0210

Indonesia – Jakarta
Phone: +6221-526-7852
Fax: +6221-526-7856

Japan – Kawasaki, Kanagawa
Phone: +81-44-844-8079
Fax: +81-44-844-8733
Product Information Center: (Technical Support)
Phone: +81-44-844-8013
Fax: +81-44-812-3200
Raychem Products
Phone: +81-44-900-5102
Fax: +81-44-5025-5027

Korea – Seoul
Phone: +82-2-3274-0535
Fax: +82-2-3274-0524/0531

Malaysia – Selangor
Phone: +60-3-7053055
Fax: +60-3-7053066

New Zealand – Auckland
Phone: +64-9-634-4580
Fax: +64-9-634-4586

Philippines – Makati City
Phone: +632-867-8641
Fax: +632-867-8661

People's Republic of China
Hong Kong
Phone: +852-2735-1628
Fax: +852-2735-0243

Shanghai
Phone: +86-21-6485-0602
Fax: +86-21-6485-0728

Shunde
Phone: +86-765-775-1368
Fax: +86-765-775-2823

Singapore – Singapore
Phone: +65-4820-3111
Fax: +65-4821-012

Raychem Products
Phone: +65-4866-151
Fax: +65-6545-514

Taiwan – Taipei
Phone: +886-2-2664-9977
Fax: +886-2-2664-9900

Thailand – Bangkok
Phone: +66-2-955-0500
Fax: +66-2-955-0505

Vietnam – Ho Chi Minh City
Phone: +84-8-8232-546/7
Fax: +84-8-8221-443

Europe/Middle East/Africa

Austria – Vienna
Phone: +43-190-560-0
Fax: +43-190-560-1333

Belgium – Kessel-Lo
Phone: +32-16-352-300
Fax: +32-16-352-352

Bulgaria – Sofia
Phone: +359-2-971-2152
Fax: +359-2-971-2153

Czech Republic – Kurim
Phone: +420-5-41-162-111
Fax: +420-5-41-162-223

Denmark – Viby J
Phone: +45-70-15-52-00
Fax: +45-86-29-51-33

Egypt – Cairo
Phone: +20-2-417-76-47
Fax: +20-2-419-23-34

Estonia – Tallinn
Phone: +372-65-05-474
Fax: +372-65-05-470

Finland – Helsinki
Phone: +358-95-12-34-20
Fax: +358-95-12-34-250

France – Cergy-Pontoise
Phone: +33-1-3420-8888
Fax: +33-1-3420-8600
Product Information Center: (Technical Support)
Phone: +33-1-3420-8943
Fax: +33-1-3420-8623

France
Tyco Electronics Export – St Ouen L'Aumone
Phone: +33-1-3440-7200
Fax: +33-1-3440-7220 or +33-1-3440-7230

Germany – Bensheim
Phone: +49-6251-133-0
Fax: +49-6251-133-1600
Product Information Center: (Technical Support)
Phone: +49-6251-133-1999
Fax: +49-6251-133-1988

Germany – Langen
Phone: +49-6103-709-0
Fax: +49-6103-709-1223

Germany – Speyer
Phone: +49-6232-30-0
Fax: +49-6232-30-2243

Germany
HTS Division – Neunkirchen
Phone: +49-2247-305-0
Fax: +49-2247-305-122

Great Britain – Stanmore Middlesex
Phone: +44-181-954-2356
Fax: +44-181-954-6234
Product Information Center: (Technical Support)
FreePhone GB: 0800-267-666
Phone: +44-141 810 8967...69
Fax: +44-141 810 8971
Great Britain – Dorcan, Swindon
Raychem Products
Phone: +44-1793-528171
Fax: +44-1793-572516

Greece – Athens
Phone: +30-1-9370-396/397
Fax: +30-1-9370-655

Hungary – Budapest
Phone: +36-1-289-1000
Fax: +36-1-289-1010

Ireland – Dublin
Phone: +353-1-820-3000
Fax: +353-1-820-9790

Israel – Yokneam
Phone: +972-4-959-0508
Fax: +972-4-959-0506

Italy – Collegno (Torino)
Phone: +39-011-4012-111
Fax: +39-011-4031-116

Lithuania – Vilnius
Phone: +370-5-21-31-402
Fax: +370-5-21-31-403

Netherlands – 's-Hertogenbosch
Phone: +31-73-6246-246
Fax: +31-73-6212-365
Product Information Center: (Technical Support)
Phone: +31-73-6246-999
Fax: +31-73-6246-998

Norway – Nesbru
Phone: +47-66-77-88-99
Fax: +47-66-77-88-55

Poland – Warsaw
Phone: +48-22-45-76-700
Fax: +48-22-45-76-720

Romania – Bucharest
Phone: +40-1-311-3479+3596
Fax: +40-1-312-0574

Russia – Moscow
Phone: +7-095-926-55-06...09
Fax: +7-095-926-55-05

Russia – St. Petersburg
Phone: +7-812-325-30-83
Fax: +7-812-325-32-88

Scotland – Dundee
Madison Cable Products
Phone: +44-1382-508080
Fax: +44-1382-505060

Slovakia – Banská Bystrica
Phone: +421-48-415-20-11/12
Fax: +421-48-415-20-13

Slovenia – Ljubljana
Phone: +386-1561-3270
Fax: +386-1561-3240

South Africa – Port Elizabeth
Phone: +27-41-405-4500
Fax: +27-41-486-1314

Spain – Barcelona
Phone: +34-93-291-0330
Fax: +34-93-201-7879
Product Information Center: (Technical Support):
Phone: +34-93-291-0330
Fax: +34-93-200-3779

Sweden – Upplands Väsby
Phone: +46-8-50-72-50-00
Fax: +46-8-50-72-50-01

Switzerland – Steinach
Phone: +41-71-447-0447
Fax: +41-71-447-0444

Turkey – Istanbul
Phone: +90-212-281-8181...3
+90-212-282-5130/5430
Fax: +90-212-281-8184

Ukraine – Kiev
Phone: +38-044-238-6908
Fax: +38-044-568-5740

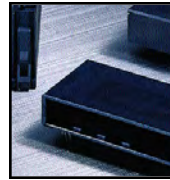
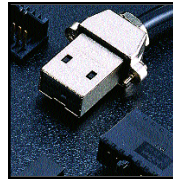

AMP DYNAMIC SERIES CONNECTORS