

Interfaces

Product Facts

- Pins and sockets have low insertion force
- High current ratings with very low resistance
- All plated products are gold or silver plated
- Louvertac bands have a temperature range from -196°C to $+200^{\circ}\text{C}$ available
- Formed bands are available for up to 1.250 [31.75] pin diameter

The transfer of high current with manageable insertion and withdrawal forces has always presented a challenge to the connector industry.

Louvertac bands provide a unique means of transferring high amperage with a resultant space and weight savings. Tyco Electronics Corporation offers a wide

range of pin and socket sizes for your applications. Strip and formed Louvertac bands are also offered for customer use in their own contact design. The wide variety of flat and formed male and female bands provide the ability to design electrical connections more inexpensively and quickly.

Louvertac products are your high current applications solution.

The variety of pins and sockets available from Tyco Electronics Corporation provide a quick and simple solution to most high current applications.

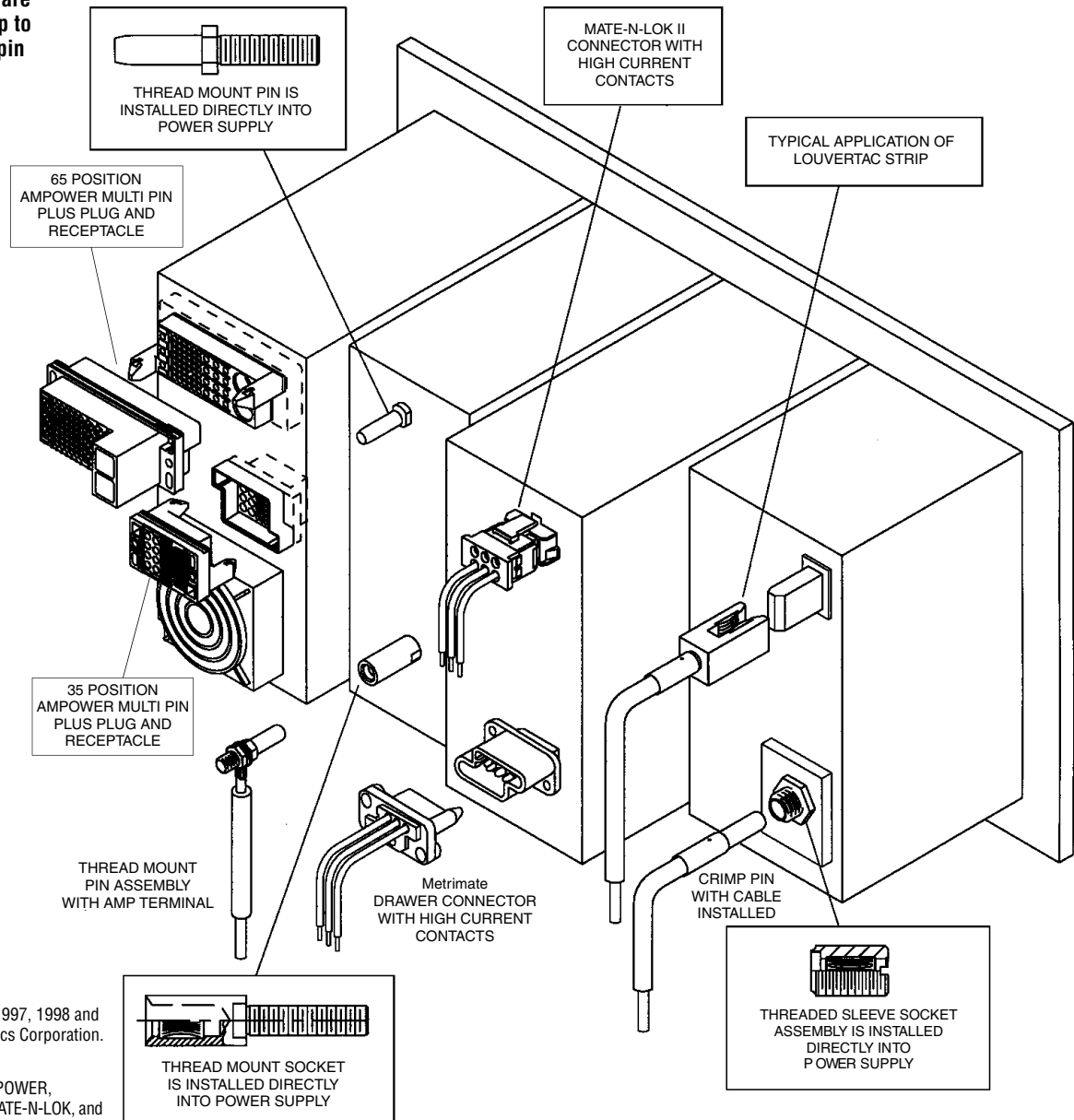

© 1992, 1993, 1995, 1997, 1998 and 2001 by Tyco Electronics Corporation. All Rights Reserved.

AMP, AMPLIMITE, AMPPOWER, DYNA-CRIMP, LGH, MATE-N-LOK, and TYCO are trademarks.

Other products, logos, and Company names mentioned herein may be trademarks of their respective owners.



Answers
to your
questions
are just a
phone call or
mouse click
away.

tyco
Electronics

On-Line Catalog

<http://catalog.tycoelectronics.com>

If you prefer to find your information electronically, check out our web site featuring a catalog containing over 135,000 products. Customer drawings, specifications, test reports, CAD models and electrical SPICE models, PCB layouts and panel cutouts can be downloaded from the web site. Cross references to hundreds of competitors makes it even easier to find the right part for nearly any application.

Technical Support Center

1-800-522-6752

www.tycoelectronics.com/help

Our Technical Support Specialists provide information on distributor locations, drawing/prints, application/product specifications, PCB layouts, technical information, plating, electrical characteristics, dimensions, value added capabilities, and 3D modeling/simulation.

Tooling Assistance

1-800-522-6752

www.tycoelectronics.com/help

Tooling support specialists will assist you in selecting hand tools, machines and applicators, identify tooling parts, and provide information about maintenance, adjustment and repair.

Customer Service

1-800-522-6752

www.tycoelectronics.com/help

Receive price and delivery information immediately. You can also place new orders, change or expedite existing orders, and request product samples and literature through the Customer Service Department.

AMP FAX[®] Service

1-800-522-6752

Documents available through AMP FAX include part numbers/catalog pages, drawings, application/product specifications, PCB layouts, and distributor information. Order as many as 20 pages of information at a time, with more than 100,000 drawings, specs, and more available.

Table of Contents

Interfaces2

Thread Mount Socket and Pin Assembly4

Threaded Sleeve Socket Assembly and Application5

Crimp Pins6

Crimp Sockets7

High Current Upgrade Program —

 Metrimate Drawer Connector Contacts, Size 88

 Universal MATE-N-LOK II Connectors9, 10

 Type XII Contacts11

 Size 16, Type II and Type III+ Contacts12

 Size 20 Posted Contacts13

AMPOWER Multi Pin Plus Connectors —

 Standard 2-, 3-, 4- and 8-Position Modules14

 Standard 65-Position15

 Standard 35-Position16

 39-Position17

 43-Position18

 35-Position and 28-Position19, 20

 24-Position and 11-Position20

 2-Position21

 9 mm Pin and Socket Crimp Contacts22

 9 mm Thread Mount Pin and Socket Contacts23

 3 mm Pin and Socket Crimp Contacts24

 3 mm Solder Tail Pin and Socket Contacts25

 Type III+ Signal Posted Contacts25

 3 mm Hot Mate Pin and Socket26

 Multimate Pin and Socket Contacts26

 Type III+ Crimp Contacts26

 High Current Size 16 Contacts and Solder Tail Pin27

 Connector Mounting Options28

 Contact Sequential Mating Cycle29

Fork Connectors30

Louvertac Strip, Torsional Louver Type31

Louvertac Strip, Bridge Louver Type32

Preformed Female Louvertac Bands33-35

Preformed Male Louvertac Bands35, 36

Part Number Index37

Need more information?

Call the Technical Support Center:
1-800-522-6752

The Center is staffed with specialists well versed in all AMP products. The Center can provide you with:

- Technical Support
- Catalogs
- Technical Documents
- Product Samples
- Authorized Distributor Locations

Thread Mount Socket and Pin Assembly

Thread Mount Sockets

These sockets are designed for easy installation and removal. The large variety of sizes have ratings from 30 continuous amps and can be mated with Thread Mount Pins and Crimp Pins.

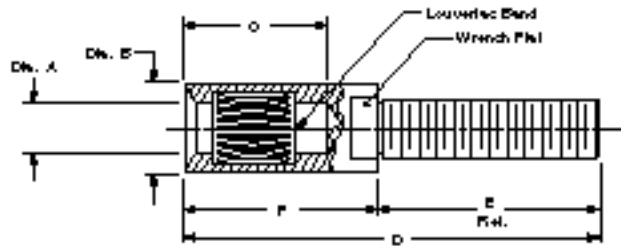
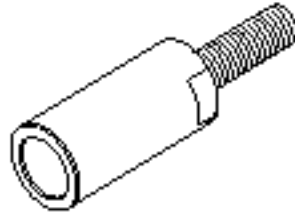

Material

Body — Brass

Louvertac Band — Beryllium Copper

Finish

Body — Silver

Louvertac Band — See Table

Mating Pin Dia.	Part Number	Thread	Contin. Current (Amp)	Voltage Drop (mV)	Dimensions						Louvertac Band Plating
					A Dia.	B Dia.	C	D	E Ref.	F	
2 mm	192059-1	M3x0.5	30	12	.080 2.0	.220 5.6	.670 17.0	1.42 36.1	.630 16	.790 20.1	Silver
4 mm	192129-1	10-32	60	10	.160 4.1	.280 7.1	.790 20.1	2.00 50.8	1.00 25.4	1.00 25.4	Gold
6 mm	192211-1	1/4-28	100	11	.240 6.1	.410 10.4	.800 20.3	2.09 53.1	1.00 25.4	1.09 27.7	Gold
8 mm	192271-1	5/16-24	185	12	.320 8.1	.560 14.2	1.40 35.6	3.07 78	1.42 36.0	1.65 41.9	Silver

Thread Mount Pins

These pins are designed for thread mount. The large variety of sizes have ratings from 30 continuous amps and are designed to be mated with Thread Mount Sockets, Threaded Sleeve Sockets and Crimp Sockets.

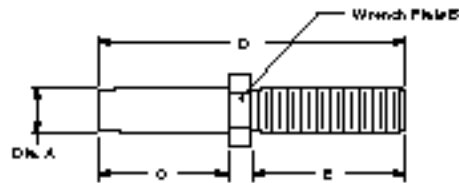
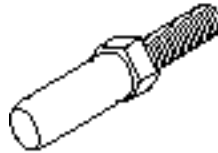

Material — Brass

Finish — Silver

Pin Dia.	Part Number	Thread	Contin. Current (Amp)	Dimensions				
				A Dia.	B	C	D	E Ref.
2 mm	192085-1	M3x0.5	30	.080 2.0	.16 4.1	.65 16.5	1.40 35.6	.63 15.0
4 mm	192161-1	10-32	60	.160 4.1	.25 6.4	.77 19.6	1.91 48.5	.99 25.1
6 mm	192244-1	1/4-28	100	.240 6.1	.31 7.9	.77 19.6	2.03 51.6	1.11 25.2
8 mm	192293-1	5/16-24	185	.320 8.1	.44 11.2	1.30 33.0	2.95 74.9	1.47 37.3

Threaded Sleeve Socket Assembly and Application

Threaded Sleeve Sockets

The Threaded Sleeve Socket Assembly is designed for High Current in a restricted space. The Sleeve can be screwed directly into a threaded bus bar or it may be inserted into a drilled hole in the bus bar with tightened nuts on each side of the bus bar. A Crimp Pin or Thread Mount Pin can be attached to a cable for the completed connector.

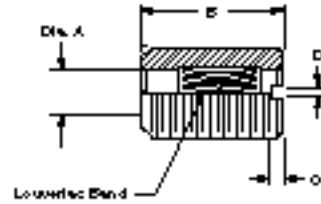
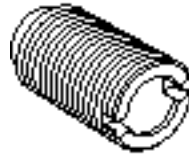

Material

Body— Brass

Louvertac Band— Beryllium Copper

Finish

Body— Silver

Louvertac Band—

See Table

Mating Pin Dia.	Part Number	Thread	Contin. Current (Amp)	Voltage Drop (mV)	Dimensions				Louvertac Band Plating
					A Dia.	B	C	D	
2 mm	1-192447-0	5/16-32	30	12	.090 2.3	.650 16.5	.060 1.5	.060 1.5	Silver
4 mm	192447-8	5/16-32	60	10	.160 4.1	.770 19.6	.060 1.5	.060 1.5	Gold
6 mm	192447-2	1/2-20	100	11	.240 6.1	.770 19.6	.078 2.0	.078 2.0	Gold
8 mm	1-192447-8	9/16-18	185	12	.320 8.1	1.35 34.3	.100 2.5	.100 2.5	Silver
12 mm	1-192447-2	3/4-16 UNF -2A	290	13	.479 12.2	1.34 34.0	.130 3.3	.130 3.3	Silver

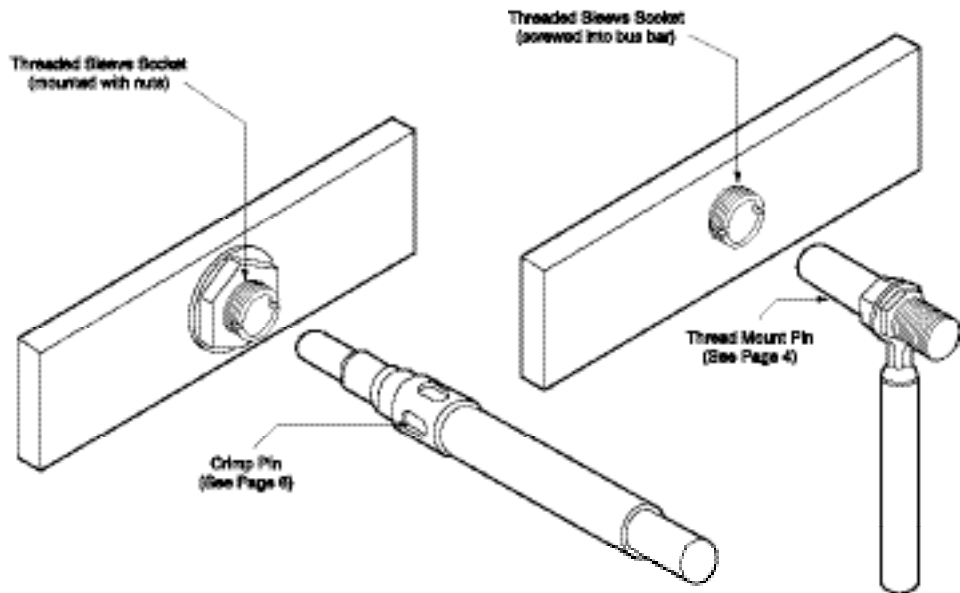

Crimp Pins

Crimp Pins feature a mechanism for locking the pin into a housing designed by the customer. The 2 mm and 4 mm pins are crimped with a Daniels Hand Crimp Tool. Pin sizes from 6 mm to 8 mm may be crimped with the indicated tooling and a DYNA-CRIMP 69120-1 electric-hydraulic power unit. The large variety of sizes have ratings from 24 continuous amps and can be mated with Thread Mount Socket Assemblies, Threaded Sleeve Socket Assemblies or Crimp Sockets.

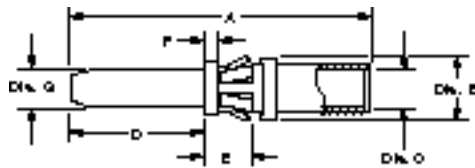

Material

Body — Copper Alloy

Retention Spring — Stainless Steel or Beryllium Copper

Finish

Body — Silver

Pin Dia.	Part No.	Contin. Current (Amp)	Voltage Drop (mV)	Dimensions							Use with AWG	Tooling Part Numbers		
				A	B Dia.	C Dia.	D	E	F	G Dia.		Crimp Die	Crimp Head	Extraction Tool
2 mm	193837-1	24	10	1.40 35.6	.225 5.72	.100 2.54	.640 16.3	.211 5.36	.050 1.27	.080 2.0	14	M310	TP1019	318813-1
	193837-1	30	12	1.40 35.6	.225 5.72	.100 2.54	.640 16.3	.211 5.36	.050 1.27	.080 2.0	12	M310	TP1019	318813-1
4 mm	193837-2	44	8	1.53 38.9	.300 7.6	.145 3.7	.750 19.1	.211 5.36	.050 1.27	.160 4.0	10	M310	TP1020	679916-1
	193837-3	60	8	1.53 38.9	.300 7.6	.181 4.60	.750 19.1	.211 5.36	.050 1.27	.160 4.0	8	M310	TP1020	679916-1
6 mm	193837-4	76	9	1.64 41.7	.410 10.4	.235 5.97	.760 19.3	.211 5.36	.050 1.27	.240 6.0	6	69133-1	69099	679917-1
	193837-5	100	9	1.73 43.9	.410 10.4	.290 7.37	.760 19.3	.211 5.36	.050 1.27	.240 6.0	4	69134-2	69099	679917-1
8 mm	193837-6	135	10	2.50 63.5	.570 14.5	.390 9.91	1.30 33.0	.211 5.36	.050 1.27	.320 8.0	2	46765-3	69099	679918-1
	193837-7	185	12	2.63 66.8	.570 14.5	.487 12.37	1.30 33.0	.211 5.36	.050 1.27	.320 8.0	1/0	46766-2	69099	679918-1

Notes: 1. Additional information on AMPPOWER terminal hydraulic crimping is available in Catalog 82025.
2. Application Specification — 114-16022

Crimp Sockets

Crimp Sockets feature a mechanism for locking the socket into a housing designed by the customer. An AMP extraction tool is offered to remove the contact. The 2 mm and 4 mm sockets are crimped with a Daniels Hand Crimp Tool. Socket sizes from 6 mm to 8 mm may be crimped with the indicated tooling and a DYNA-CRIMP 69120-1 electric-hydraulic power unit. The large variety of sizes have ratings from 24 continuous amps and can be mated with Thread Mount Pins or Crimp Pins.

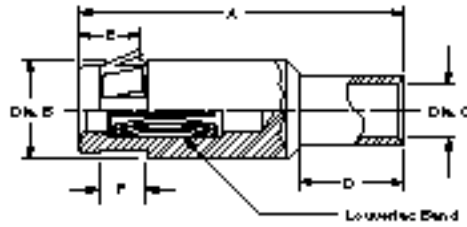

Material

- Body** — Copper Alloy
- Louvertac Band** — Beryllium Copper
- Retention Spring** — Stainless Steel or Beryllium Copper

Finish

- Body** — Silver
- Louvertac Band** — Silver

Mating Pin Dia.	Part No.	Contin. Current (Amp)	Voltage Drop (mV)	Dimensions						Use with AWG	Tooling Part Numbers		
				A	B Dia.	C Dia.	D	E	F		Crimp Die	Crimp Head	Extraction Tool
2 mm	193673-1	24	10	1.13 28.7	.230 5.8	.100 2.54	.420 10.7	.211 5.36	.209 5.31	14	M310	TP1021	318813-1
	193673-1	30	12	1.13 28.7	.230 5.8	.100 2.54	.420 10.7	.211 5.36	.209 5.31	12	M310	TP1021	318813-1
4 mm	193673-2	44	8	1.31 33.3	.300 7.6	.145 3.68	.400 10.2	.211 5.36	.209 5.31	10	M310	TP1022	679916-1
	193673-3	60	8	1.31 33.3	.300 7.6	.181 4.60	.410 10.4	.211 5.36	.209 5.31	8	M310	TP1022	679916-1
6 mm	193673-4	76	9	1.42 36.1	.410 10.4	.235 5.97	.460 11.7	.211 5.36	.209 5.31	6	69133-1	69099	679917-1
	193673-5	100	9	1.48 37.6	.410 10.4	.290 7.37	.530 13.5	.211 5.36	.209 5.31	4	69134-2	69099	679917-1
8 mm	193673-6	135	10	2.26 57.4	.570 14.5	.390 9.91	.640 16.3	.211 5.36	.209 5.31	2	46765-3	69099	679918-1
	193673-7	185	12	2.45 62.2	.570 14.5	.487 12.37	—	.211 5.36	.209 5.31	1/0	46766-2	69099	679918-1
12 mm	193673-8*	290	13	2.51 63.7	.795 20.19	.541 13.74	.930 23.62	—	—	2/0	46767-2	69099	—
20 mm	1-193673-2*	480	11	3.17 80.5	1.072 27.23	.721 18.31	1.24 31.50	—	—	250 MCM	46751-2	69099	—

* Socket contact uses retention ring (not supplied) for locking contact in housing. See Application Specification 114-16022 for details.

- Notes:** 1. Additional information on AMPPOWER terminal hydraulic crimping is available in Catalog 82025.
 2. Application Specification — 114-16022

High Current Upgrade Program — Metrimate Drawer Connector Contacts, Size 8

The Louvertac bands have the versatility of being designed into contact dimensions used in existing AMP connectors.

Metrimate High Current contacts have been designed to fit into the existing Drawer Connector housings. A fully energized 8 position connector with 8 gage wires can handle 30 amps per line with a 30°C T-rise on either the cable-to-cable or cable-to-board.

Cable-to-Cable

Material

- Contact Body** — Copper Alloys
- Louvertac Band** — Beryllium Copper
- Retention Spring** — Stainless Steel
- Finish** — Gold

Product Specification

108-1449 Metrimate Pin and Socket with Louvertac High Current Contact

Connector Voltage Rating — 600 VAC

■ **Recognized under the Component Program of Underwriters Laboratories Inc., File No. E28476**



■ **Certified by Canadian Standards Association, File No. LR7189A**



Contacts

Wire Size AWG	Contact Part Numbers		Crimp Tools
	Pin	Socket	
8	193457-1	193458-1	Daniels Hand Tool #M310 or AMP P/N 356114-1 Positioner #TP944 or AMP P/N 356336-1
10	193642-1	193643-1	
12-14	193534-1	193535-1	

Extraction Tool Part No. 318813-1 or 305183-6

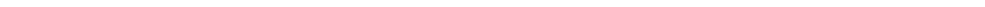

Cable-to-Board

Material

- Contact Body** — Copper Alloys
- Louvertac Band** — Beryllium Copper
- Retention Spring** — Stainless Steel
- Finish** — Gold

A typical application would have solder tail pins mounted into the receptacle and crimp sockets mounted into the plug.

■ **Recognized under the Component Program of Underwriters Laboratories Inc., File No. E28476**



■ **Certified by Canadian Standards Association, File No. LR7189A**

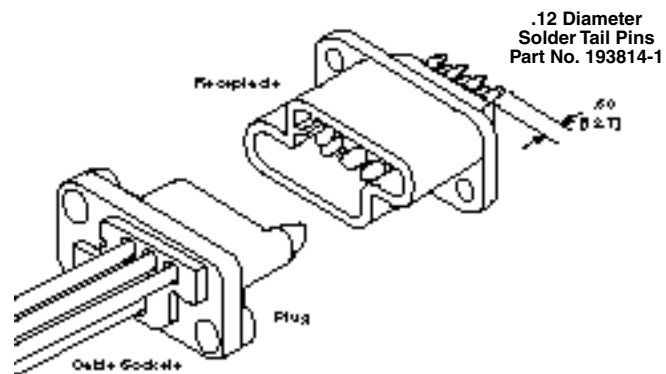

Drawer Connector Housings

Size Configuration	Housing Part Numbers	
	Plug	Receptacle
8 Positions (8 Size 8 Cavities)	213499-1	213500-1
15 Positions (3 Size 8 Cavities & 12 Size 16 Cavities)	213426-1	213427-1

Extraction Tool Part No. 318813-1

Notes: 1. High Current contacts with Louvertac bands are NOT intermateable with any other contact.
2. Additional information on connectors is available in Catalog 82045.

High Current Upgrade Program — Universal MATE-N-LOK II Connectors

The Louvertac bands have the versatility of being designed into contact dimensions used in existing AMP connectors. Universal MATE-N-LOK II High Current contacts have been designed to fit into an existing Universal MATE-N-LOK II housing. In a cable-to-cable application, the initial T-Rise test of a fully energized 2 circuit connector with 10 gage wires has shown a 32 amp capability per line with a 30°C T-rise.

Cable-to-Cable

Material

Body — Copper Alloy
Louvertac Band — Beryllium Copper
Finish — See Table
 Latch Disengaging Tool Part No. 58382-1

■ **Recognized under the Component Program of Underwriters Laboratories Inc., File No. E28476**

■ **Certified by Canadian Standards Association, File No. LR7189A**

■ **Passed test by VDE under their Registration Number 3915/Continuous Surveillance**

Design Objective — 108-1583
Application Specification — 114-16021
Connector Voltage Rating — 600 VAC

Cable-to-Right-Angle Board

When the Louvertac contacts are used in a cable-to-r/a board application, the initial T-Rise test of a fully energized 2 circuit connector with 10 gage wire and a 2 oz. foil board has shown a 32 amp capability per line with a 30°C T-rise.

Material

Housing — UL 94V-0 Nylon
Contact Body — Copper Alloy
Louvertac Band — Beryllium Copper
Finish — Silver
Solder Tail Diameter — .052 [1.32]

■ **Recognized under the Component Program of Underwriters Laboratories Inc., File No. E28476**

■ **Certified by Canadian Standards Association, File No. LR7189A**

■ **Passed test by VDE under their Registration Number 3915/Continuous Surveillance**

Design Objective — 108-1594
Connector Voltage Rating — 600 VAC

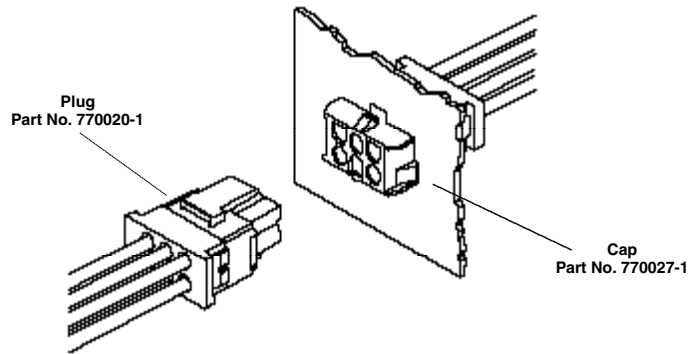

Contacts

Wire Size AWG	Contact Part Numbers		Louvertac Band Plating	Crimp Tools	Lubricated
	Pin	Socket			
10	193796-1	193797-1	Silver	Daniels Hand Tool #M310 or AMP P/N 356114-1, Positioner #TP1013 or AMP P/N 356337-1	No
12-14	193841-1	193842-1	Silver		No
12-14	—	193842-3	Gold		No
10	194210-1	194211-1	Silver		Yes
12-14	194212-1	194213-1	Silver		Yes

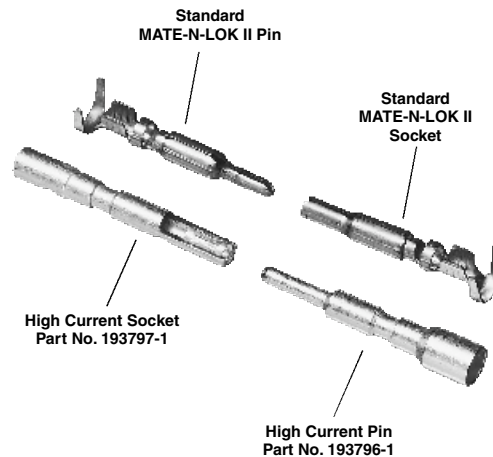

Connector Housings

No. of Circuits	Kit Part Numbers	
	Plug	Cap
2	770017-1	770024-1
3	770018-1	770025-1
4	770019-1	770026-1
5	770016-1	—
6	770020-1	770027-1
9	770021-1	770028-1
12	770022-1	770029-1
15	770023-1	770030-1

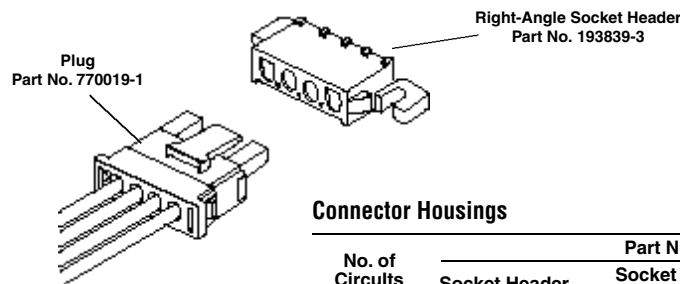

Connector Housings

No. of Circuits	Part Numbers		
	Socket Header	Socket Header with Lubricated Contacts*	Mates with Plug Housing
2	193839-1	194214-1	770017-1
3	193839-2	—	770018-1
4	193839-3	194215-1	770019-1
5	193839-4	—	770016-1

*Mates with plug housing shown and with lubricated MATE-N-LOK II high current pin contacts.

Notes: 1. High Current contacts with Louvertac bands are NOT intermateable with any other contact.
 2. Additional information on connectors is available in Catalog 82181.

High Current Upgrade Program — Universal MATE-N-LOK II Connectors (Continued)

Vertical Pin Headers

High Current Universal MATE-N-LOK II Vertical Pin Headers are designed to mate with Universal MATE-N-LOK II Plugs with High Current Socket contacts. All housings are polarized to provide for proper circuit board placement. Eight versions are available from 2 circuits to 15 circuits. In a cable-to-vertical board application, the initial T-rise of a fully energized 2 circuit connector with 10 gage wire and a 2 oz. foil board has shown a 36 amp capability per line with a 30°C T-rise.

Material

Housing — UL 94V-0 Nylon

Contacts — Copper Alloy

Solder Tail Diameter — .052 [1.32]

Finish — Silver

■ **Recognized under the Component Program of Underwriters Laboratories Inc.,**  File No. E28476

■ **Certified by Canadian Standards Association,**  File No. LR16455-113

■ **Passed test by VDE under their Registration Number 3915/Continuous Surveillance**

Design Objective — 108-1594

Connector Voltage Rating — 600 VAC

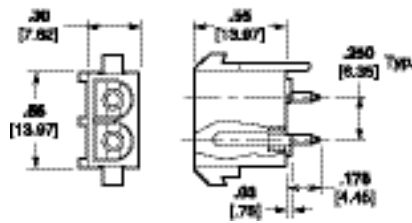

2 Circuit
Part No. 194009-1,
* Part No. 194269-1 (Lubricated Contacts)

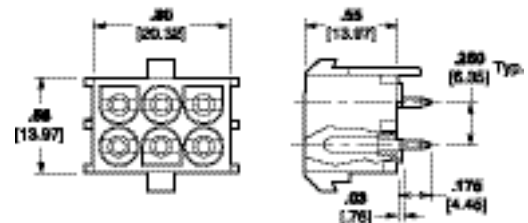

6 Circuit
Part No. 194002-1, Part No. 194002-2 (.235 [5.97] Tail Length), Part No. 194002-3 (Tube Packaged),
* Part No. 194260-1 (Lubricated Contacts)

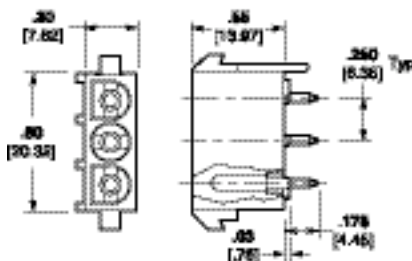

3 Circuit
Part No. 194017-1,
* Part No. 194610-1 (Lubricated Contacts)

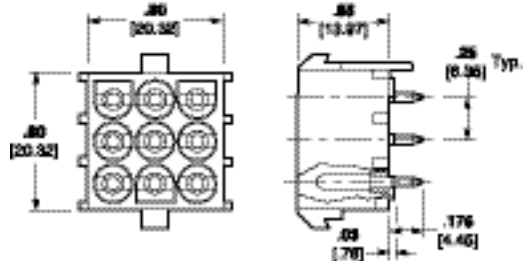

9 Circuit
Part No. 194012-1

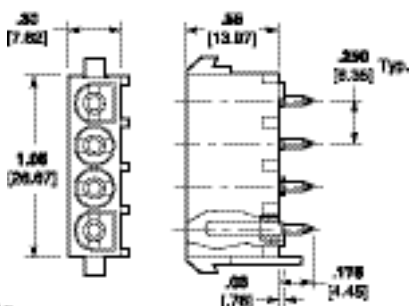

4 Circuit
Part No. 194010-1,
* Part No. 194234-1 (Lubricated Contacts)

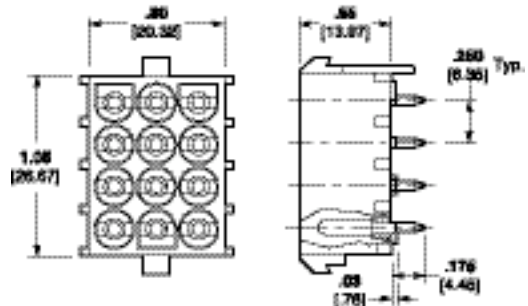

12 Circuit
Part No. 194014-1, Part No. 194014-2 (Tube Packaged)

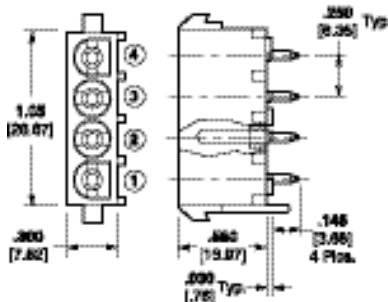

4 Circuit
Select Load (See Table)

Pin Location	Part No.	
	194096-2	194096-5
①	S	H
②	H	H
③	S	S
④	S	S

S = Standard MATE-N-LOK II Contact
H = High Current MATE-N-LOK II Contact

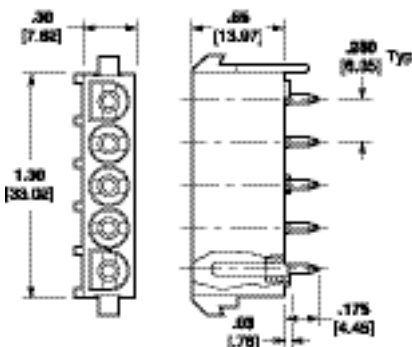

5 Circuit
Part No. 194018-1

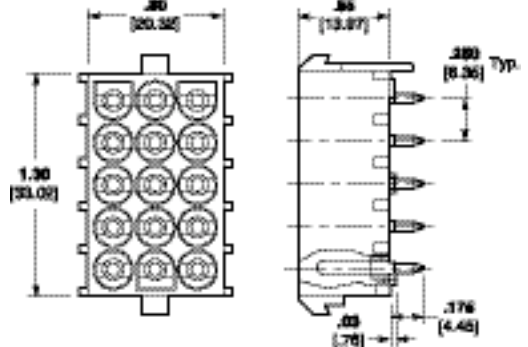

15 Circuit
Part No. 194013-1

Notes: 1. High Current contacts with Louvertac bands are NOT intermateable with any other contact.
2. Additional information on connectors is available in Catalog 82181.
3. Recommended PC Board Thickness .062 [1.57].

*Mate with MATE-N-LOK II plug housings with lubricated high current socket contacts.

High Current Upgrade Program — Type XII Contacts

The features of the High Current Type XII contact have been designed to fit into the existing AMP Multimate Connectors such as CPC (Circular Plastic Connector), CMC (Circular Metal Connector), G Series, and M Series housings. An initial T-Rise test in free air has shown a 60 amp capability with a 30°C T-Rise with 8 gage wires. The contact may be crimped onto 8 AWG wire with a Daniels Hand Tool M310 or AMP P/N 356114-1 and Positioner TP1068S or AMP P/N 356119-1.

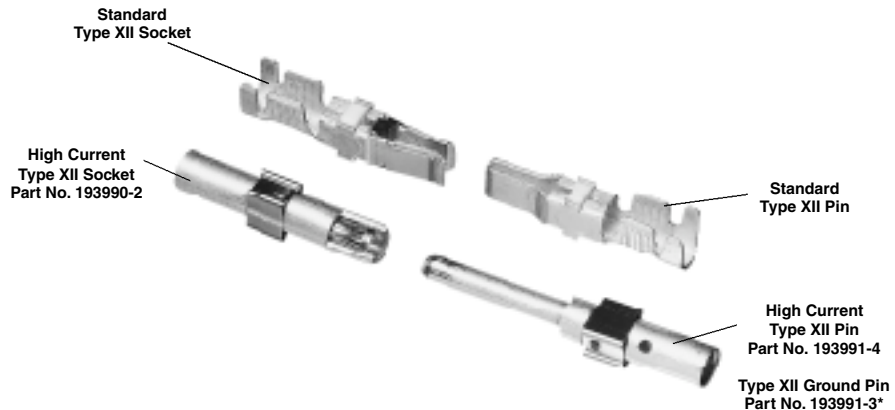

* Not recommended for CPC connectors.

Cable-to-Cable

Material

- Body** — Copper Alloy
- Louvertac Band** — Beryllium Copper
- Retention Spring** — Stainless Steel
- Finish**
- Body** — Silver
- Louvertac Band** — Gold



Extraction Tool Part No. 224155-1

Current-Carrying Capacity. The graph shows current-carrying capacity versus temperature rise for a fully energized 3 position CPC plug P/N 206037-2 and receptacle P/N 206036-2. These initial representative amperage ratings were conducted with 8 AWG wires that were 3 feet long.

■ **Recognized under the Component Program of Underwriters Laboratories Inc., File No. E28476**



Current Rating for 30°C Temperature Rise 100% Energized

3 Circuit Connector (Wire-to-Wire)

TEMPERATURE RISE VS CURRENT

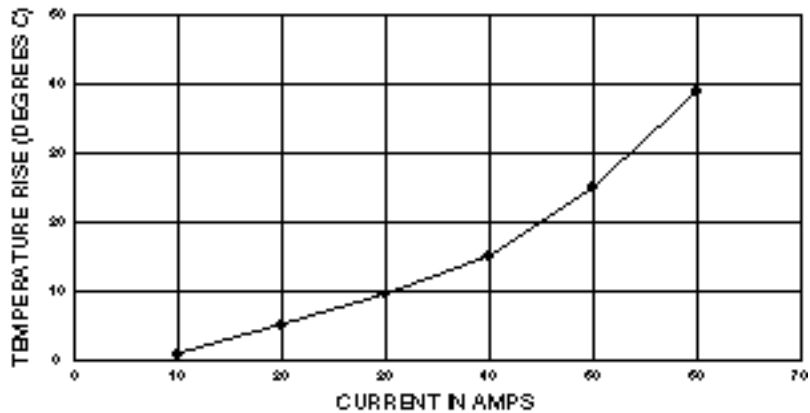

Plug
(For Sockets)



Square Flange Receptacle
(For Pins)

Notes: 1. High Current contacts with Louvertac bands are NOT intermateable with any other contact.

2. Additional information on CPC and CMC connectors is available in Catalog 82021.
3. Additional information on G Series connectors is available in Catalog 82046.
4. Additional information on M Series connectors is available in Catalog 82003.
5. Additional information on LGH connectors is available in Catalog 82024.

High Current Upgrade Program — Size 16, Type II and Type III+ Contacts

The features of the High Current Size 16 contact have been designed to fit into the existing AMP Multimite Connectors such as CPC (Circular Plastic Connector), CMC (Circular Metal Connector), G Series, M Series, Econoseal Metrimate Square Grid and Drawer Connector housings. An initial T-Rise test in free air has shown a 23 amp capability with a 30°C T-Rise. The contact may be crimped onto 14 AWG wire with an AMP hand tool P/N 601967-1. Use turret TH502 (1-601967-6) for the pin and turret TH501 (1-601967-5) for the socket.

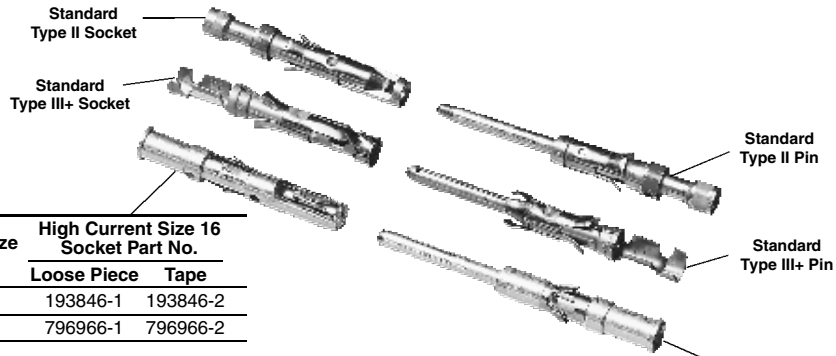

Wire Size AWG	High Current Size 16 Socket Part No.	
	Loose Piece	Tape
14	193846-1	193846-2
18-16	796966-1	796966-2

Wire Size AWG	High Current Size 16 Pin Part No.	
	Loose Piece	Tape
14	193844-1	193844-2
18-16	796964-1	796964-2



Material

Pin Body — Leaded Brass; Copper Alloy (Board Mount)

Socket Body — Copper Alloy

Louvertac Band — Beryllium Copper

Retention Spring — Stainless Steel

Finish

Body — Silver

Louvertac Band — Gold



Extraction Tool Part No. 305183



4 Pos. CPC Posted Square Flange Receptacle
Part No. 796764-1
Mates with CPC Plug (Part No. 206060-1) with either Type II or High Current Socket contact

Current-Carrying Capacity. The graph shows current-carrying capacity versus temperature rise for a fully energized 6 position Metrimate Square Grid plug P/N 207152-1 and receptacle P/N 207153-1. These initial representative amperage ratings were conducted with 14 AWG wires that were 2 feet long.

Current Rating for 30°C Temperature Rise 100% Energized
6 Circuit Metrimate Connector (Wire-to-Wire)

TEMPERATURE RISE VS. CURRENT

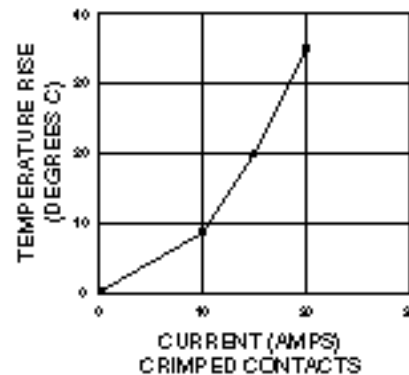

■ **Recognized under the Component Program of Underwriters Laboratories Inc., File No. E28476**

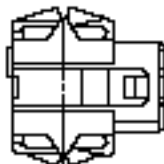
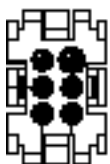

Plug (for Sockets)

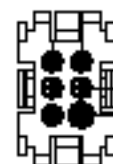
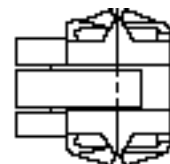
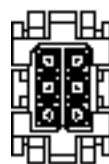
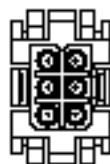

Receptacle (for Pins)

- Notes:**
1. High Current contacts with Louvertac bands are NOT intermateable with any other contact.
 2. Additional information on CPC and CMC connectors is available in Catalog 82021.
 3. Additional information on G Series connectors is available in Catalog 82046.
 4. Additional information on M Series connectors is available in Catalog 82003.
 5. Additional information on Metrimate connectors is available in Catalog 82045.
 6. Additional information on Econoseal connectors is available in Catalog 82057.
 7. Additional information on LGH connectors is available in Catalog 82024.

High Current Upgrade Program — Size 20 Posted Contacts

The High Current Size 20 contact has been designed to fit into the Series 109 AMPLIMITE Connectors per MIL-C-24308.

Material

Body — Copper Alloy

Louvertac Band — Beryllium Copper

Finish

Body — Gold

Louvertac Band — Gold

Current-Carrying Capacity. The High Current Size 20 contact with a 20 gage wire attached to the .030 diameter solder tail acquired an initial 30°C T-Rise of 11.85 amps in free air.

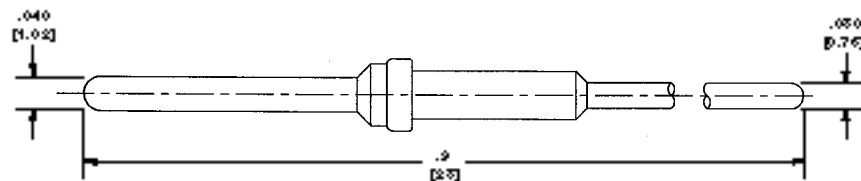
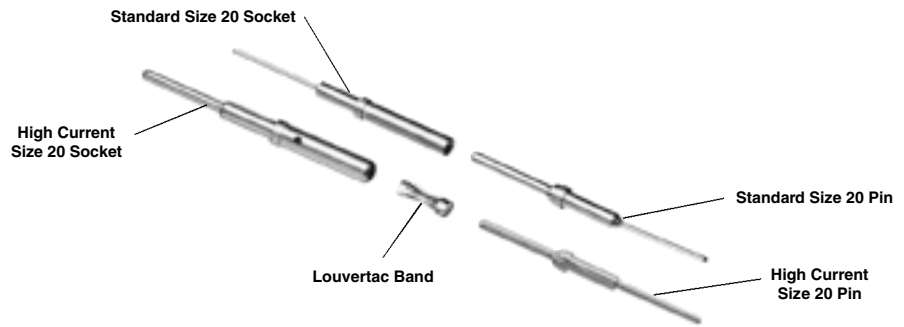

Pin Part No. 194081-1

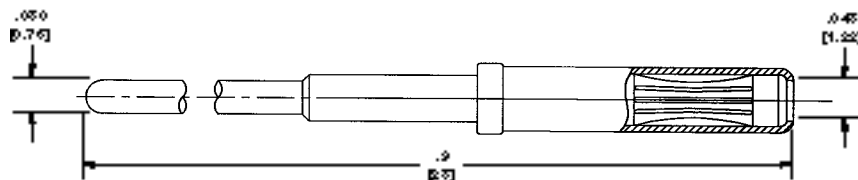

Socket Part No. 194083-1

The contacts can be sold loose piece or installed into any of the MIL Standard connectors.



Pin and Socket Insertion/Extraction Tool

Part Number **91067-2** or MIL number **M81969/1-02**

Insertion tip, for replacement Part Number **126195-3**

Extraction tip, for replacement Part Number **126195-4**

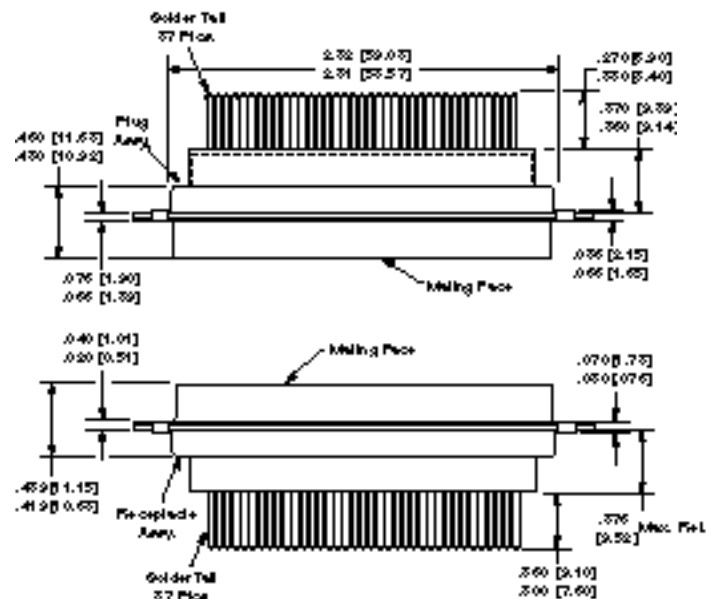

Typical Fully-Loaded 37 Position Plug and Receptacle

Notes: 1. High Current contacts with Louvertac bands are NOT interchangeable with any other contact.
2. Additional information on connectors is available in Catalog 82069.

AMPOWER Multi Pin Plus Connector

The AMPOWER Multi Pin Plus Connector is manufactured from a modular mold that allows the finished housing to be molded into thousands of different contact configurations. Standard modules are offered in 2, 3, 4 and 8 positions with contact ampere ratings ranging from signal to 150 amps. Pin contacts can be installed into the Plug Housing or the Receptacle Housing. Socket contacts can be installed into the Plug Housing or the Receptacle Housing. Any combination of the modules could be selected and molded into a one-piece housing from 1" to 6" long. Custom modules can be designed and molded to fit many other AMP contacts. Dimensions shown below are the approximate width of each module.* The connector can be used in blindmate drawer, wire-to-wire, wire-to-board, and board-to-board applications.

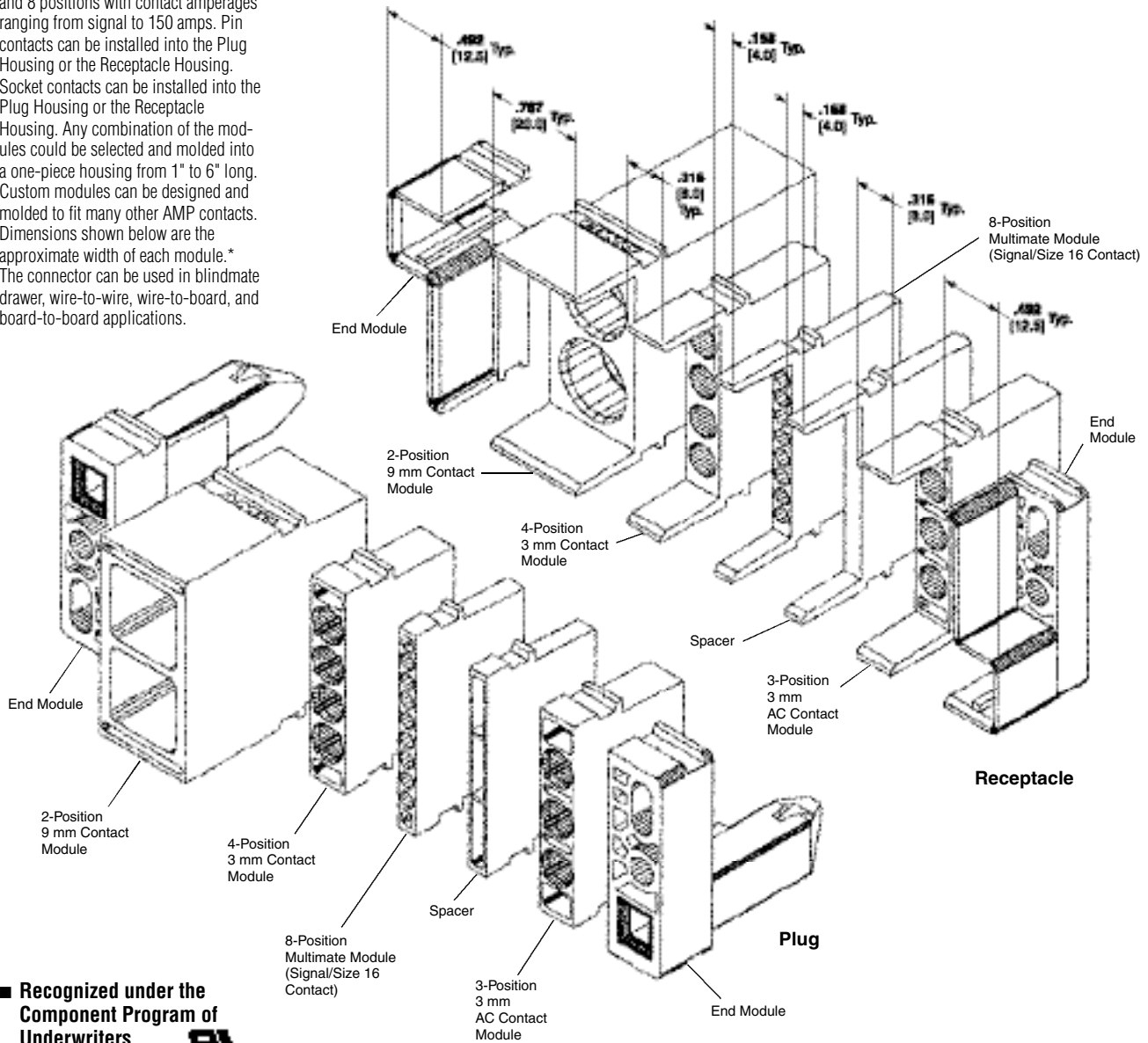

■ **Recognized under the Component Program of Underwriters Laboratories Inc., File No. E28476**

■ **Certified by Canadian Standards Association, File No. LR 39825**

Product Specification
108-1809

*For example: Using both end modules (always required) and a 2-position 9 mm contact module, a 4-position 3 mm contact module, and two (2) 8-position signal/size 16 contact modules would produce a connector approximately 2.402 [61.0] in length (.492 [12.5] x 2 + .787 [20.0] + .315 [8.0] + .158 [4.0] x 2).

AMPOWER Multi Pin Plus Connector (Continued)

Standard 65-Position Plug and Receptacle Housing

Designed to accept 65 contacts from signal level to 150 amps.

The housing accepts:

- 2 - 9 mm Contacts
- 12 - 3 mm Contacts
- 48 - Signal/Size 16 Contacts
- 3 - 3 mm AC Contacts

Material — Polyester, UL 94V-0 rating

Connector Voltage Rating —
250 VAC

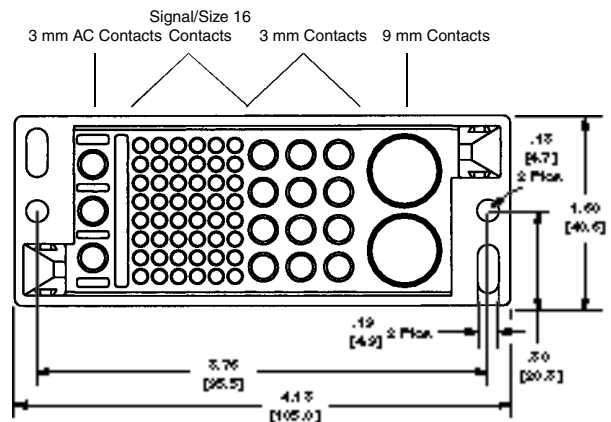
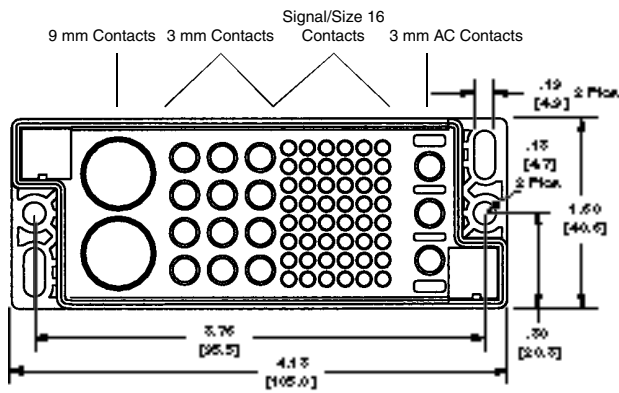
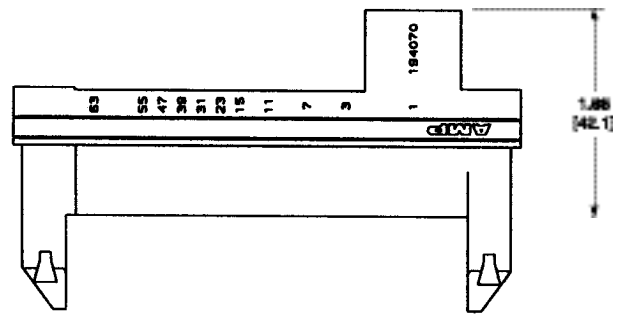
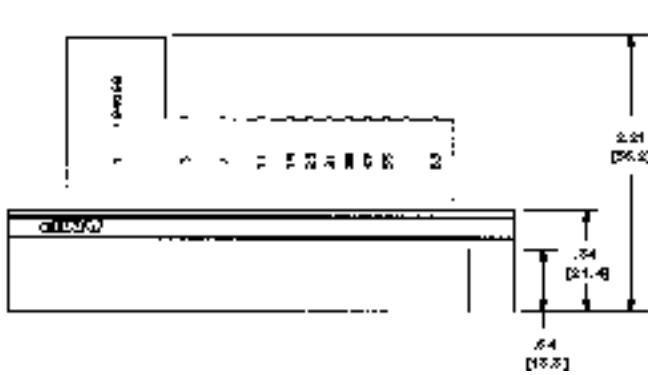

Receptacle
194069-1 (shown)
194069-3 with two 6-32 inserts
(Front Mounted)

Plug
194070-1 (shown)
194070-3 with two 6-32 inserts
(Front Mounted)

■ Recognized under the
Component Program of
Underwriters
Laboratories Inc.,
File No. E28476



■ Certified by Canadian
Standards
Association,
File No. LR7189A



AMPOWER Multi Pin Plus Connector (Continued)

Standard 35-Position Plug and Receptacle Housing

Designed to accept 35 contacts from signal level to 30 amps.

The housing accepts:

- 8 - 3 mm Contacts
- 24 - Signal/Size 16 Contacts
- 3 - 3 mm AC Contacts

Material — Polyester, UL 94V-0 rating

Connector Voltage Rating — 250 VAC

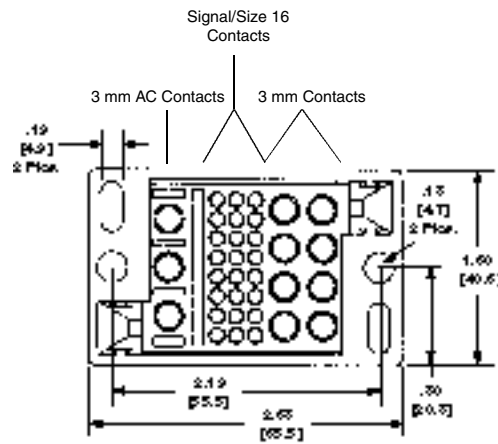
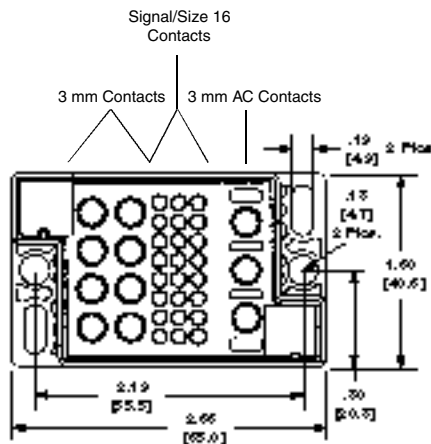
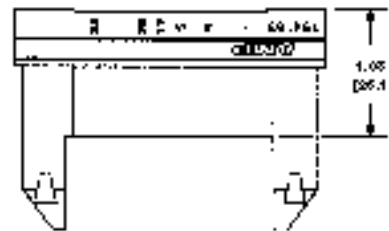
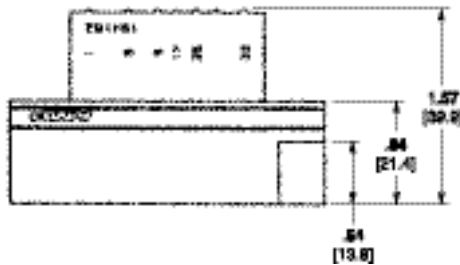

Receptacle
194182-1 (shown)
194182-3 with two 6-32 inserts
(Front Mounted)

Plug
194183-1 (shown)
194183-3 with two 6-32 inserts
(Front Mounted)

■ Recognized under the Component Program of Underwriters Laboratories Inc., File No. E28476



■ Certified by Canadian Standards Association, File No. LR7189A



AMPOWER Multi Pin Plus Connector (Continued)

39-Position Plug and Receptacle Housing

Designed to accept 39 contacts from signal level to 150 amps.

The housing accepts:
 4 - 9 mm Contacts
 8 - 3 mm Contacts
 24 - Signal/Size 16 Contacts
 3 - 3 mm AC Contacts

Material — Polyester, UL 94V-0 rating

Connector Voltage Rating —
250 VAC

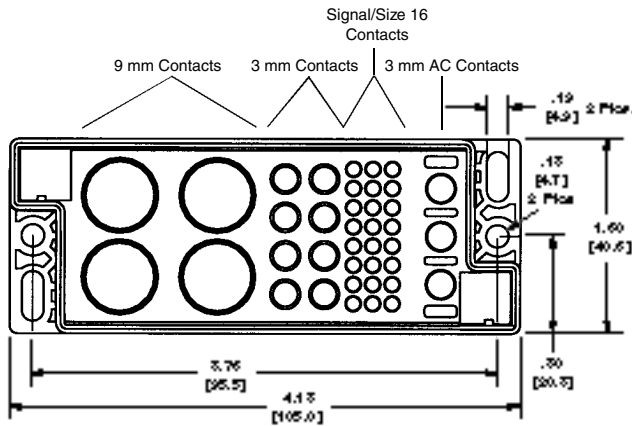
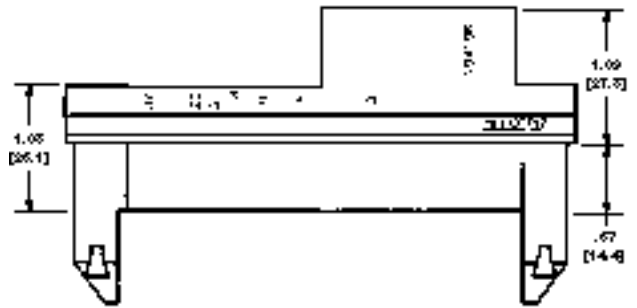
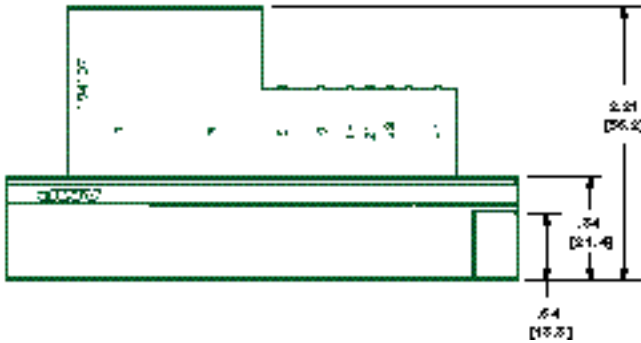

Receptacle
 194197-1 (shown)
 194197-3 with two 6-32 inserts

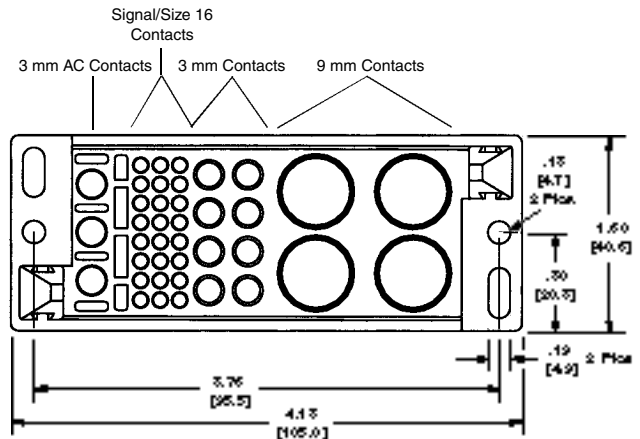

Plug
 194196-1 (shown)
 194196-3 with two 6-32 inserts

■ Recognized under the Component Program of Underwriters Laboratories Inc., File No. E28476



■ Certified by Canadian Standards Association, File No. LR7189A



AMPOWER Multi Pin Plus Connector (Continued)

43-Position Plug and Receptacle Housing

Designed to accept 43 contacts from signal level to 30 amps.

The housing accepts:

- 8 - 3 mm Contacts
- 32 - Signal/Size 16 Contacts
- 3 - 3 mm AC Contacts

Material — Polyester, UL 94V-0 rating

Connector Voltage Rating — 250 VAC

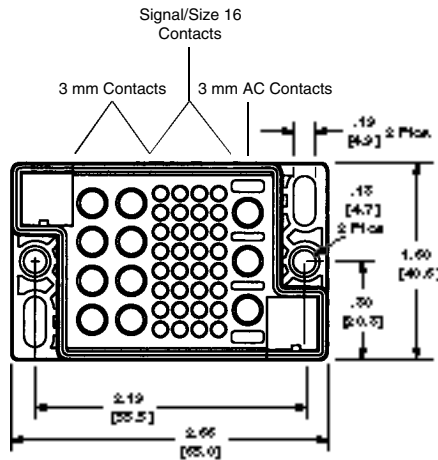
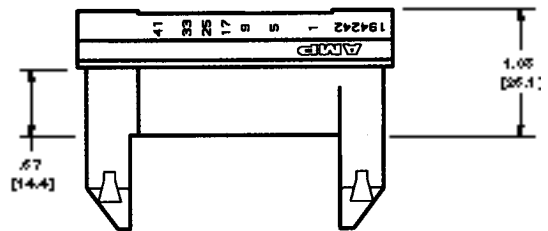
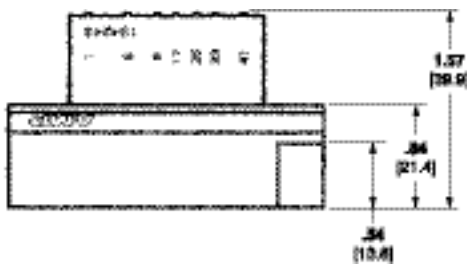

Receptacle
194243-1

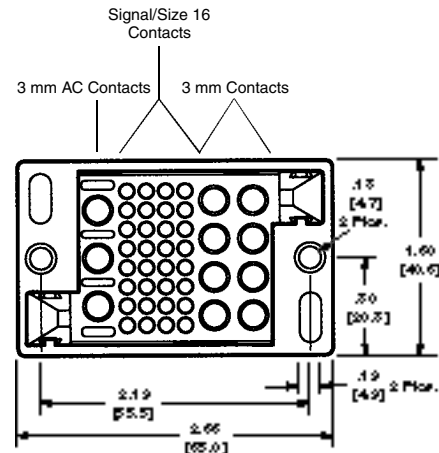

Plug
194242-1

■ Recognized under the Component Program of Underwriters Laboratories Inc., File No. E28476



■ Certified by Canadian Standards Association, File No. LR7189A



AMPOWER Multi Pin Plus Connector (Continued)

35-Position Plug and Receptacle Housing

Designed to accept 35 contacts from signal level to 30 amps.

The housing accepts:
16 - 3 mm Contacts
3 - 3 mm AC Contacts
16 - Signal/Size 16 Contacts

Material — Polyester, UL 94V-0 rating

Connector Voltage Rating —
250 VAC

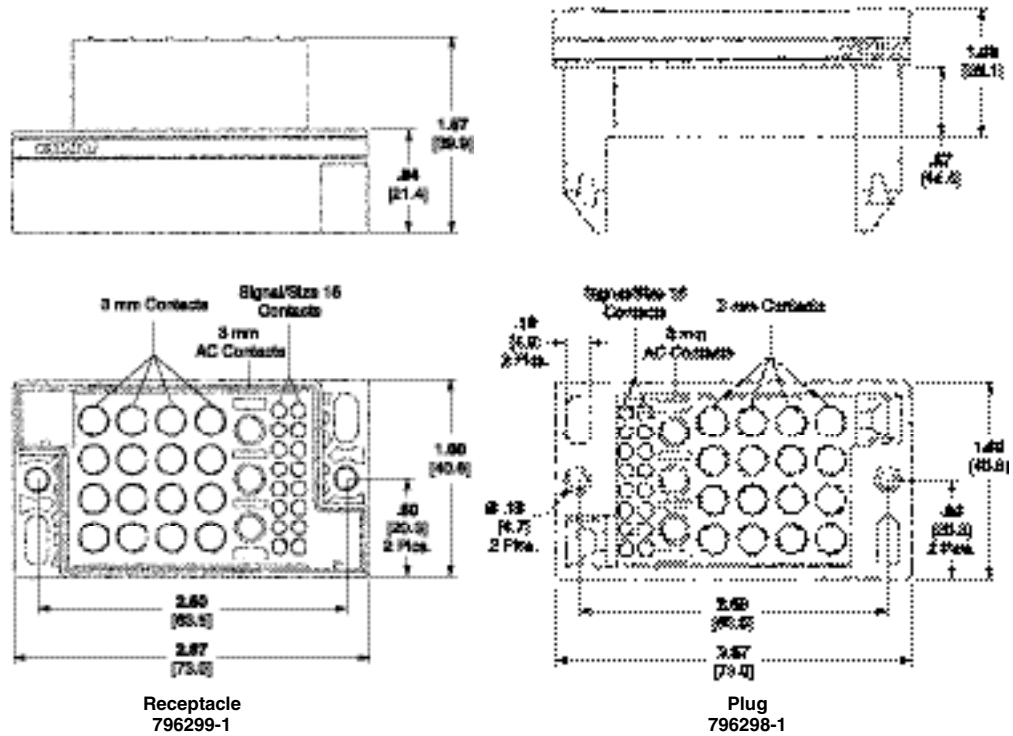

28-Position Plug and Receptacle Housing

Designed to accept 28 contacts from signal level to 30 amps.

The housing accepts:
4 - 3 mm Contacts
24 - Signal/Size 16 Contacts

Material — Polyester, UL 94V-0 rating

Connector Voltage Rating —
250 VAC

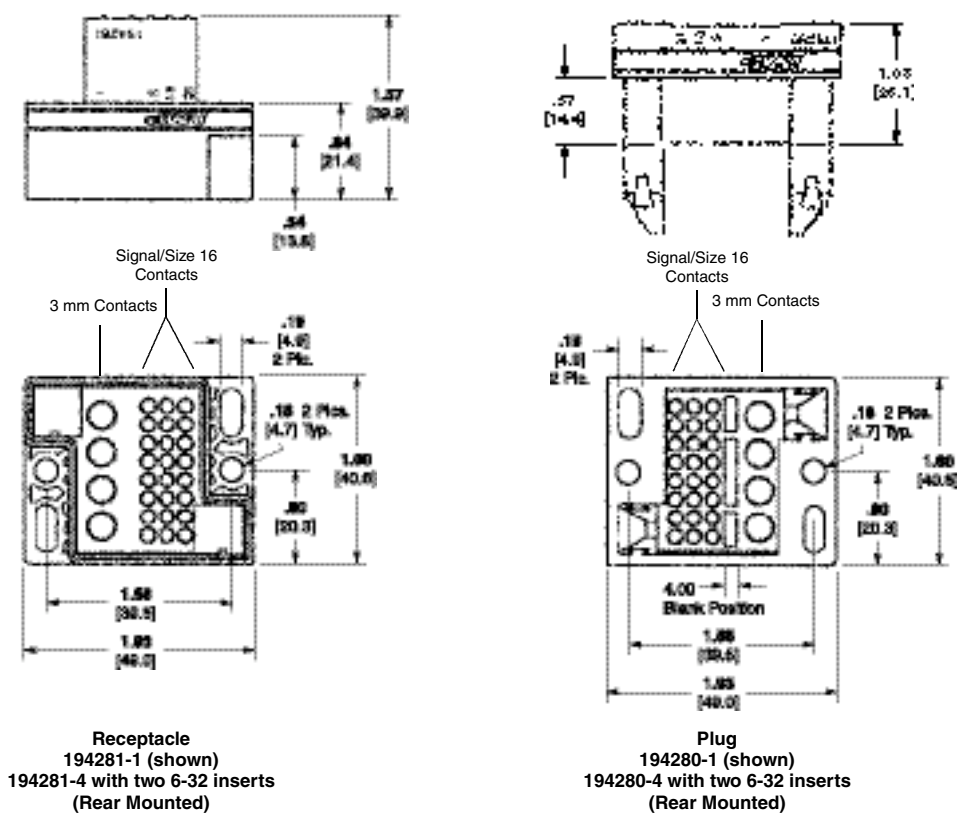

■ Recognized under the Component Program of Underwriters Laboratories Inc., File No. E28476

■ Certified by Canadian Standards Association, File No. LR7189A

Dimensions are shown for reference purposes only.

Dimensions are in inches and millimeters unless otherwise specified. Values in brackets are metric equivalents.

Specifications subject to change.

Technical Support Center
1-800-522-6752
www.tycoelectronics.com

AMPOWER Multi Pin Plus Connector (Continued)

24-Position Plug and Receptacle Housing

Designed to accept 24 contacts from signal level to 30 amps.

The housing accepts:
8 - 3 mm Contacts
16 - Signal/Size 16 Contacts

Material — Polyester, UL 94V-0 rating

Connector Voltage Rating —
250 VAC

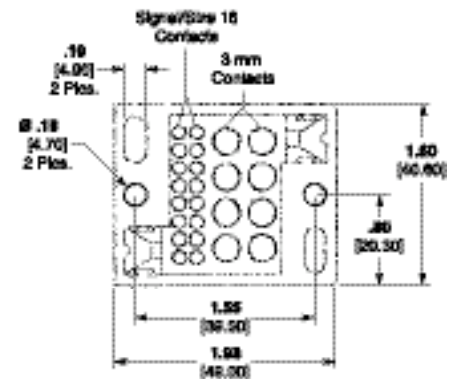
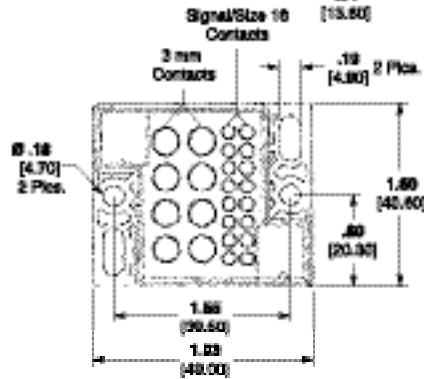
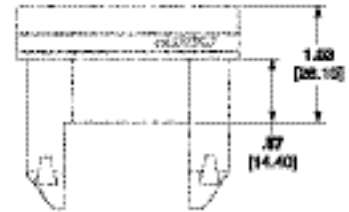
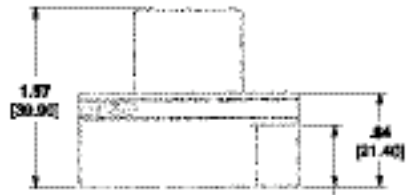

Receptacle
194299-1

Plug
194298-1

11-Position Plug and Receptacle Housing

Designed to accept 11 contacts from signal level to 30 amps. Circuit positions 9 and 11 of the plug are designed so that the socket contact is recessed 5 mm.

The housing accepts:
3 - 3 mm AC Contacts
8 - Signal/Size 16 Contacts

Material — Polyester, UL 94V-0 rating

Connector Voltage Rating —
250 VAC

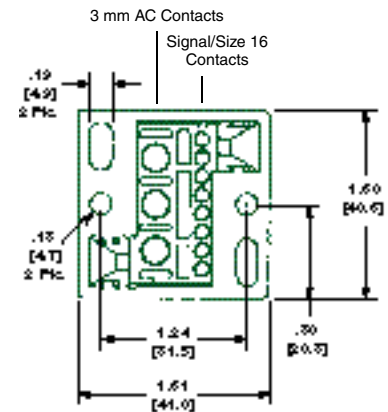
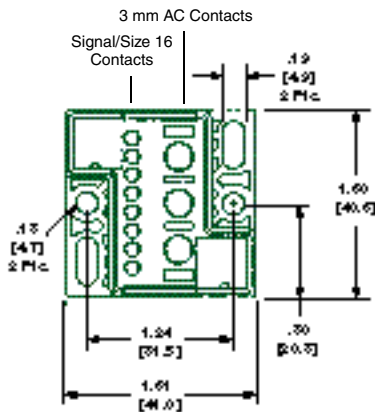
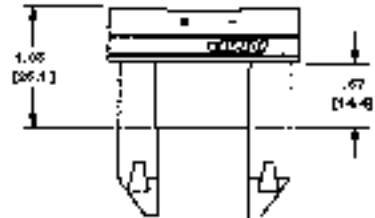
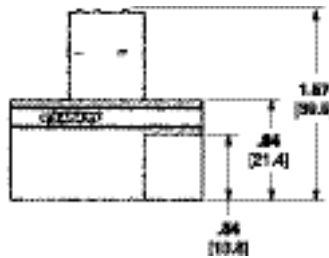

Receptacle
194279-1

Plug
194278-1

- Recognized under the Component Program of Underwriters Laboratories Inc., File No. E28476 
- Certified by Canadian Standards Association, File No. LR7189A 

AMPOWER Multi Pin Plus Connector (Continued)

2-Position Plug and Receptacle Housing

Designed to accept two 150 amp contacts.

The housing accepts:
2 - 9 mm Contacts

Material — Polyester, UL 94V-0 rating

Connector Voltage Rating —
250 VAC

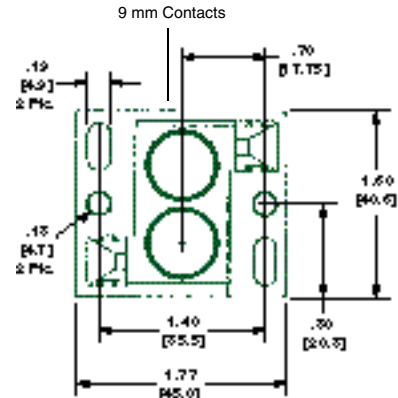
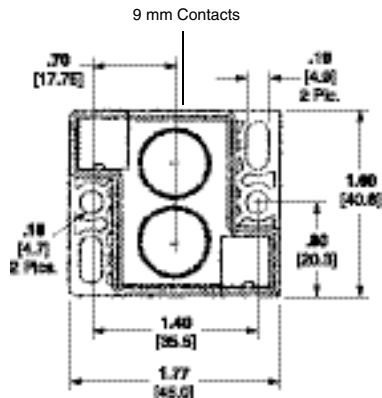
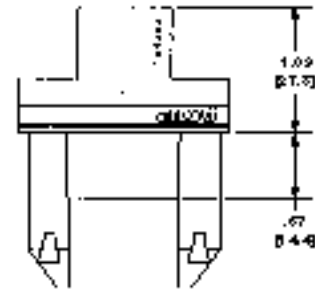
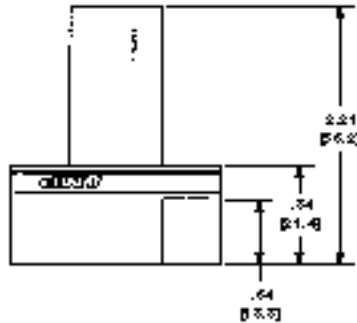

Receptacle
194283-1

Plug
194282-1

■ Recognized under the
Component Program of
Underwriters
Laboratories Inc.,
File No. E28476



■ Certified by Canadian
Standards
Association,
File No. LR7189A



AMPOWER Multi Pin Plus Connector (Continued)

9 mm Pin Crimp Contact

The 9 mm Pin is designed to fit into the 2-Position Module. The Pin has a retention spring that locks the contact into the housing cavity. The contacts are rear installed and removed with the Extraction Tool that is inserted in the mating side. The contact can be crimped with the indicated DYNA-CRIMP 69120-1 electric-hydraulic power unit.

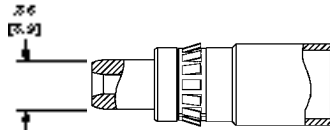

Pin
Part No. 194041-6

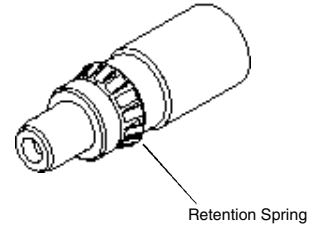

Material

Body — Copper Alloy
Retention Spring — Beryllium Copper

Finish

Body — Silver

Part No.	Current Rating (Amp)	Contact Sequence Level*	Use with AWG	Tooling Part Numbers		
				Crimp Die	Crimp Head	Extraction Tool
194041-6	150	Third Mate	1/0	46766-2	69099	662725-1

*When used with other AMPOWER Multi Pin Plus Contacts.

9 mm Socket Crimp Contact

The 9 mm Socket is designed to fit into the 2-Position Module. The Socket has a retention spring that locks the contact into the housing cavity. The Socket has a polymer ring and post that helps prevent any finger contact with bare metal surfaces when installed into the Plug or Receptacle housings. The contacts are rear installed and removed with the Extraction Tool that is inserted in the mating side. The contact can be crimped with the indicated DYNA-CRIMP 69120-1 electric-hydraulic power unit.

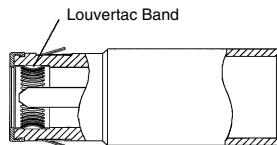

Socket
Part No. 194037-2

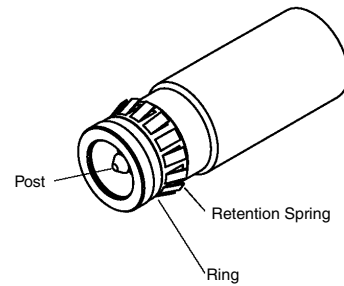

Material

Body — Copper Alloy
Retention Spring — Beryllium Copper
Louvertac Band — Beryllium Copper
Post and Ring — Acetyl

Finish

Body — Silver

Part No.	Current Rating (Amp)	Use with AWG	Tooling Part Numbers		
			Crimp Die	Crimp Head	Extraction Tool
194037-2	150	1/0	46766-2	69099	662725-1

Notes: 1. Additional wire sizes and mating levels available upon request.
2. Additional information on AMPOWER terminal hydraulic crimping is available in Catalog 82025.

AMPOWER Multi Pin Plus Connector (Continued)

9 mm Thread Mount Pin Contact

The 9 mm Pin is designed to fit into the 2-Position Module. The Pin has a retention spring that locks the contact into the housing cavity. The contacts are rear installed and removed with the Extraction Tool that is inserted in the mating side. The 1/4-28 threads are provided to mount the contact directly to a bus bar.

Material

Body — Copper Alloy

Retention Spring — Beryllium Copper

Finish

Body — Silver

Extraction Tool Part No. 662725-1

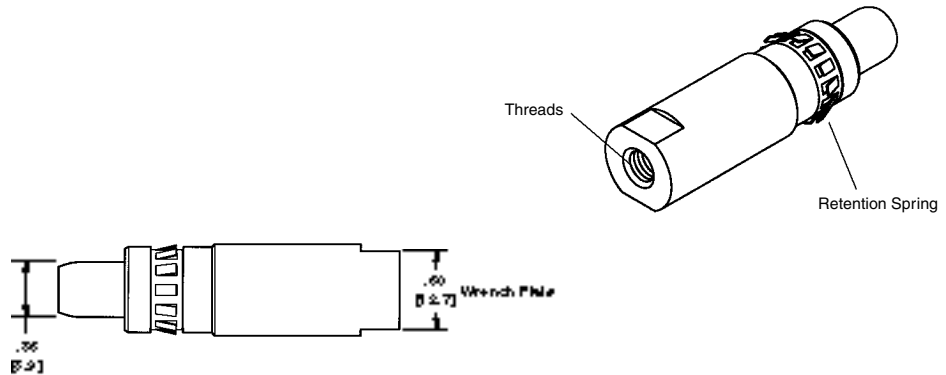

Pin
Part No. 194049-1

9 mm Thread Mount Socket Contact

The 9 mm Socket is designed to fit into the 2-Position Module. The Socket has a retention spring that locks the contact into the housing cavity. The contacts are rear installed and removed with the Extraction Tool that is inserted in the mating side. The 1/4-28 threads are provided to mount the contact directly to a bus bar.

Material

Body — Copper Alloy

Retention Spring — Beryllium Copper

Post and Ring — Acetyl

Finish

Body — Silver

Extraction Tool Part No. 662725-1

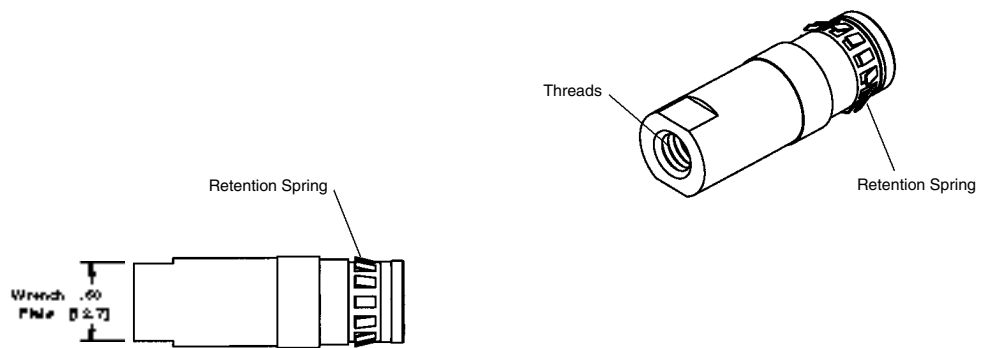

Socket
Part No. 194050-1

AMPOWER Multi Pin Plus Connector (Continued)

3 mm Pin Crimp Contact

The 3 mm Pin is designed to fit into the 3- and 4-Position Modules. The pin has a retention spring that locks the contact into the housing cavity. The contacts are rear installed and removed with the Extraction Tool that is inserted in the mating side. The contact can be crimped with a Daniels Hand Crimp Tool.

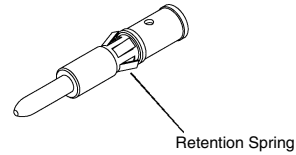
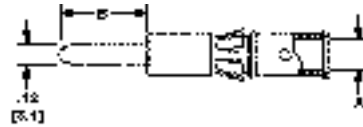

Material

Body — Copper Alloy

Retention Spring — Stainless Steel

Finish

Body — Silver

Part No.	Current Rating (Amp)	Contact Sequence	Use with AWG	Dimensions		Tooling Part Numbers		
				A	B	Crimp Hand Tool	Crimp Tool Positioner	Extraction Tool
194189-3	15	First Mate	12-14	.100 2.54	.541 13.75			
194189-6	15	Second Mate	12-14	.100 2.54	.461 11.75			
194189-7	30	Third Mate	8	.181 4.60	.384 9.75			
194189-8	25	Third Mate	10	.145 3.68	.384 9.75	M309	TP1124	356335-1
194189-9	15	Third Mate	12-14	.100 2.54	.384 9.75			
1-194189-1	30	First Mate	8	.181 4.60	.541 13.75			

3 mm Socket Crimp Contact

The 3 mm Socket is designed to fit into the 3- and 4-Position Modules. The Socket has a retention spring that locks the contact into the housing cavity. The Socket has a polymer ring that helps prevent any finger contact with bare metal surfaces when installed into the Plug or Receptacle housings. The contacts are rear installed and removed with the Extraction Tool that is inserted in the mating side. The contact can be crimped with a Daniels Hand Crimp Tool.

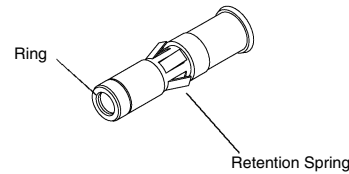
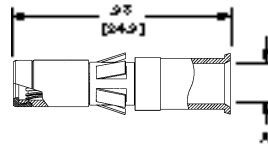

Material

Body — Copper Alloy

Retention Spring — Stainless Steel

Louvertac Band — Beryllium Copper

Ring — Acetyl

Finish

Body — Silver

Part No.	Current Rating (Amp)	Use with AWG	Dimension A	Tooling Part Numbers		
				Crimp Hand Tool	Crimp Tool Positioner	Extraction Tool
194032-5	30	8	.181 4.60			
194032-6	25	10	.145 3.68	M309	TP1125	356335-1
194032-7	15	12-14	.100 2.54			

Note: Additional wire sizes and mating levels available upon request.

AMPOWER Multi Pin Plus Connector (Continued)

3 mm Solder Tail Pin and Socket

A 3 mm Solder Tail Pin and Socket are designed to fit into the 3- and 4-Position Modules. The contacts have a retention spring that locks the contact in the housing cavity. The contacts are rear installed and removed with the Extraction Tool that is inserted in the mating side.

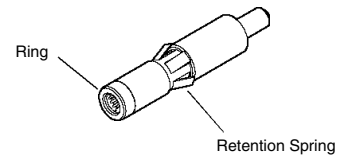
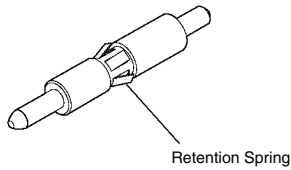

Material

Body—Copper Alloy

Retention Spring—Stainless Steel

Finish

Body—Silver

Extraction Tool Part No. 356335-1

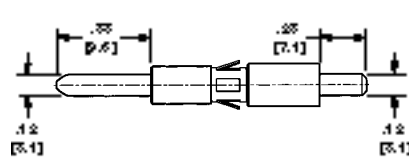

Pin
Part No. 194251-1

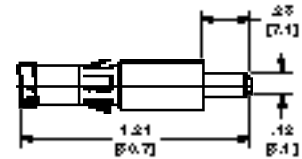

Socket
Part No. 194252-1

Type III+ Signal Posted Contacts (Replacement Contacts, See Note Below.)

Material

Contact Body and Post—Brass

Retention Spring—Stainless Steel

Finish

See chart.

†Single contact, free-air test current; not to be construed as contact rating current. Use only for testing.

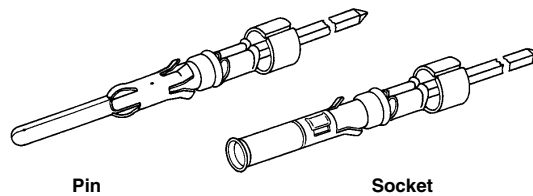

Size 16 — Pin Diameter .062 [1.57] (Test Current, 13 Amperes)†

Termination Method	Post Configuration	Contact Finish	Loose Piece Contact Part No.			
			3 Termination High Post		1 Termination High Post	
			Pin	Socket	Pin	Socket
Wrap-Type	.045 x .045 1.14 x 1.14	Sel. Gold/Nickel ¹	66471-9	66473-9	66471-7	66473-7
		Bright Tin-Lead	66471-3	66473-3	66471-1	66473-1

¹Gold flash over .000050 [0.00127] nickel on entire contact, with .000030 [0.00076] gold to a distance of .200 [5.08] from mating end. Gold thickness controlled on socket O.D.

Posts plated tin-lead over copper.

Extraction Tool Part No. 305183.

Insertion Tool Part No. 200893-2.

Note: These contacts are used as replacement contacts for all posted connectors.

AMPOWER Multi Pin Plus Connector (Continued)

3 mm Hot Mate Pin and Socket

A 3 mm Hot Mate Pin and Socket are designed to fit into the 3- and 4-Position Modules. The contacts have a retention spring that locks the contact in the housing cavity. The contacts are rear installed and removed with the Extraction Tool that is inserted in the mating side. The contact can be crimped with a Daniels Hand Crimp Tool. Two contacts were installed into the 3-Position 3 mm AC Module and subjected to 52 amps at 250 VAC for 250 cycles. Contact UL rating — 35 A.



Pin
Part No. 1-194189-0



Socket
Part No. 194245-1

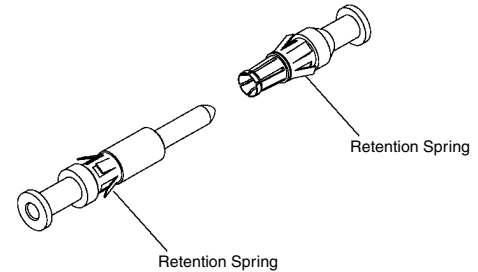

Material

Body — Copper Alloy

Retention Spring — Stainless Steel

Finish

Body — Gold

Part No.	Type	Contact Sequence	Use with AWG	Dimension A	Tooling Part Numbers		
					Crimp Hand Tool	Crimp Tool Positioner	Extraction Tool
1-194189-0	Pin	Second Mate	12-14	.100 2.55	M309	TP1124	356335-1
194245-1	Socket	—	12-14	.100 2.55	M309	TP1221	356335-1

Multimate Pin and Socket Contacts

The Multimate contacts are designed to fit into the 8-Position Module. Tyco Electronics offers many Type III+ contact wire sizes and finishes in order to fulfill most signal requirements. The Type III+ pin contacts are used in the third sequence mating cycle.

Material

Body — Brass

Retention Spring — Stainless Steel

Finish

See Table

Insertion Tools —

91002-1 (For Insulation Dia. of .070 [1.78] or less)

200893-2 (For Insulation Dia. of .090 [2.29] max.)

Extraction Tool — Part No. 305183

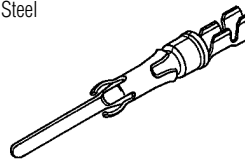

Pin

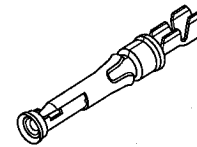

Socket

Type III+ Crimp Contacts

Contact Size — 16

Pin Diameter — .062 [1.57]

***Test Current** — 13 amperes (Single contact, free-air test current; not to be construed as contact rating current. Use only for testing.)

Contact Finish:

A — .00015 [0.00038] gold on the electrical engagement area over .00050 [0.00127] nickel.

B — .00030 [0.00076] gold on the electrical engagement area over .00050 [0.00127] nickel.

C — Tin

***Note:** Total current capacity of each contact in any given connector is dependent on the heat rise resulting from the combination of electrical loads of all contacts in the connector arrangement and the maximum ambient temperature in which the connector will be operating.

Wire Size Range AWG	Ins. Dia. Range [mm ²]	Contact Finish Code	Strip Form Contact No.		Loose Piece Contact No.		
			Pin	Socket	Pin	Socket	
30-26	0.05-0.15	.040-.060 1.02-1.52	C	66425-6	66424-6	—	—
			A	66425-7	66424-7	66429-3	66428-3
			B	66425-8	66424-8	66429-4	66428-4
		.014-.030 0.36-0.76	A	66393-7	66394-7	—	—
			B	66393-8	66394-8	66406-4	66405-4
			C	66106-6	66108-6	66107-2	66109-2
26-24	0.12-0.2	.035-.055 0.89-1.4	A	66106-7	66108-7	66107-3	66109-3
			B	66106-8	66108-8	66107-4	66109-4
			C	66102-7	66104-7	66103-2	66105-2
		.040-.080 1.02-2.03	A	66102-8	66104-8	66103-3	66105-3
			B	66102-9	66104-9	66103-4	66105-4
			C	66332-5	66331-5	66400-1	66399-1
24-20	0.2-0.6	.080-.100 2.03-2.54	A	66332-7	66331-7	66400-3	66399-3
			B	66332-8	66331-8	66400-4	66399-4
			C	66098-7	66100-7	66099-2	66101-2
		.080-.100 2.03-2.54	A	66098-8	66100-8	66099-3	66101-3
			B	66098-9	66100-9	66099-4	66101-4
			C	66359-6	66358-6	66361-2	66360-2
18-16	0.8-1.4	.080-.100 2.03-2.54	A	66359-9	66358-9	66361-3	66360-3
			B	1-66359-0	1-66358-0	66361-4	66360-4
			C	66098-7	66100-7	66099-2	66101-2

AMPOWER Multi Pin Plus Connector (Continued)

Multimate Pin and Socket Contacts (Continued)

High Current Size 16 Contacts

The High Current Size 16 contact is a Multimate contact that can be used if higher current levels are required (10-15 amps). They fit into the 8-Position Module. The Pin contact can be used in the third sequence mating cycle. AMP P/N 194046-1 is a Multimate contact that is used in the fourth sequence mating cycle and mates with any Size 16 socket.

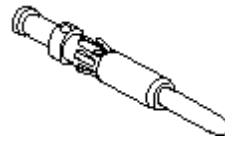

Pin



Socket

Wire Size AWG	Contact Part Number			
	Pin		Socket	
	Loose Piece	Tape	Loose Piece	Tape
14	193844-1	193844-2	193846-1	193846-2
18-16	796964-1	796964-2	796966-1	796966-2

See page 12 for additional information.

Size 16 Pin

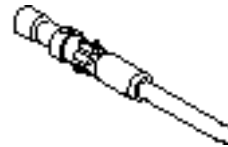

Part No.	Contact Sequence	Use with AWG	Tooling Part Numbers	
			Crimp Hand Tool	Turret
194046-1	Fourth Mate	24-20	601967-1	1-601967-6

Size 16 Solder Tail Pin

AMP P/N 194264-1 is a Multimate contact that is used as a High Current Solder Tail Pin Contact and mates with Socket P/N 193846-1.



Part No. 194264-1



Extraction Tool Part No. 305183

See page 12 for additional information.

AMPOWER Multi Pin Plus Connector (Continued)

Connector Mounting Options

The Plug and Receptacle Housings have been designed to be rigidly mounted to a surface or to float on a surface. Two screw clearance holes in the housings have been provided to allow either housing to be rigidly mounted in the recommended panel cutout. Two threaded inserts can be installed into these holes upon request. Large slots in the housings have been provided to allow either hous-

ing to float within the window of the recommended panel cutout. Shoulder screw length will vary based on panel thickness and housing selection. All hardware is commercially available. The X-Y float principle that utilizes the panel cutout and the housing allows as much as 3/16 [4.76] misalignment between the housings.

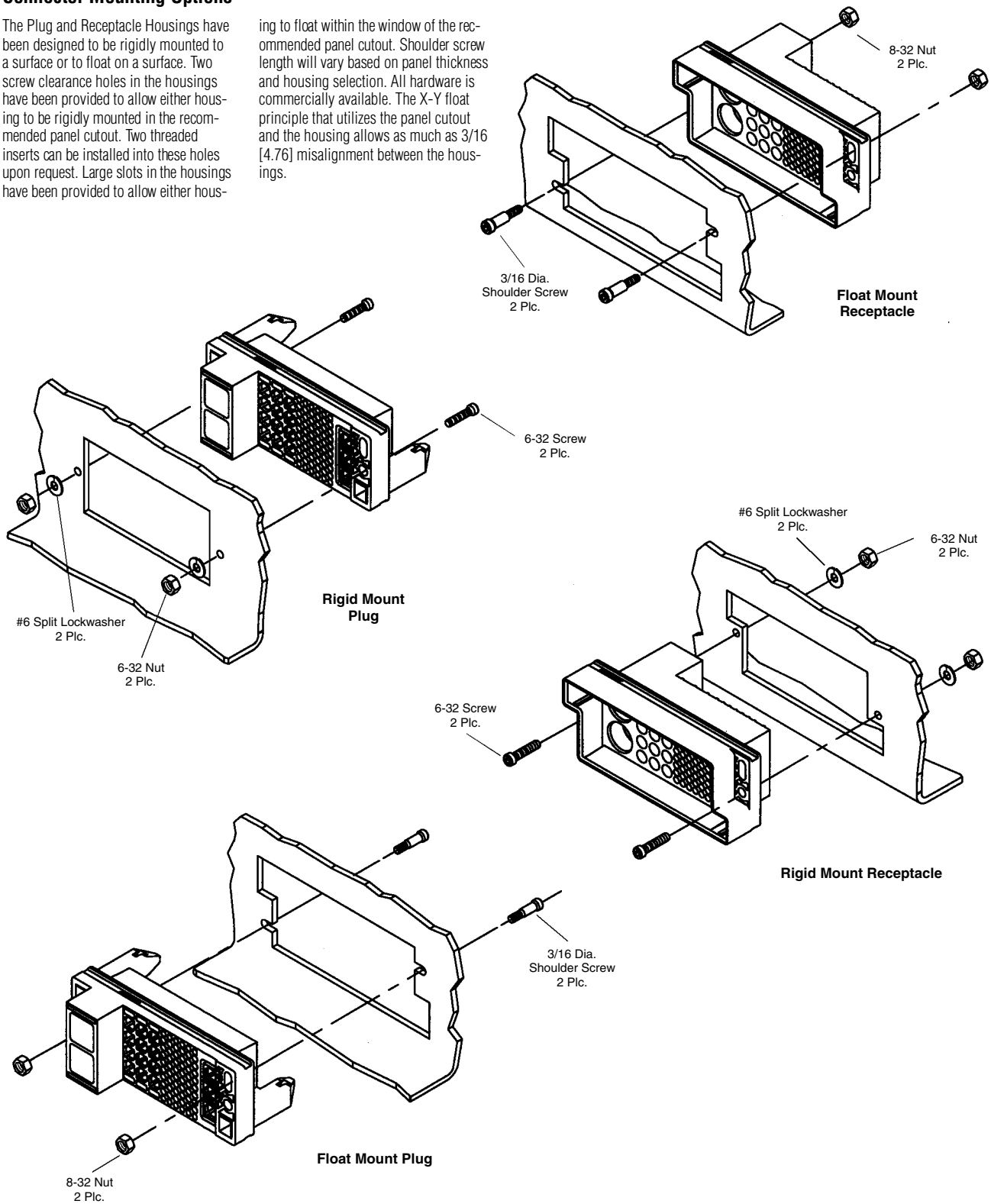

Panel cutout dimensions are shown on the customer drawing.

AMPOWER Multi Pin Plus Connector (Continued)

Contact Sequential Mating Cycle

A family of Pins have been designed to have four levels of sequence during the Plug and Receptacle mating cycle.

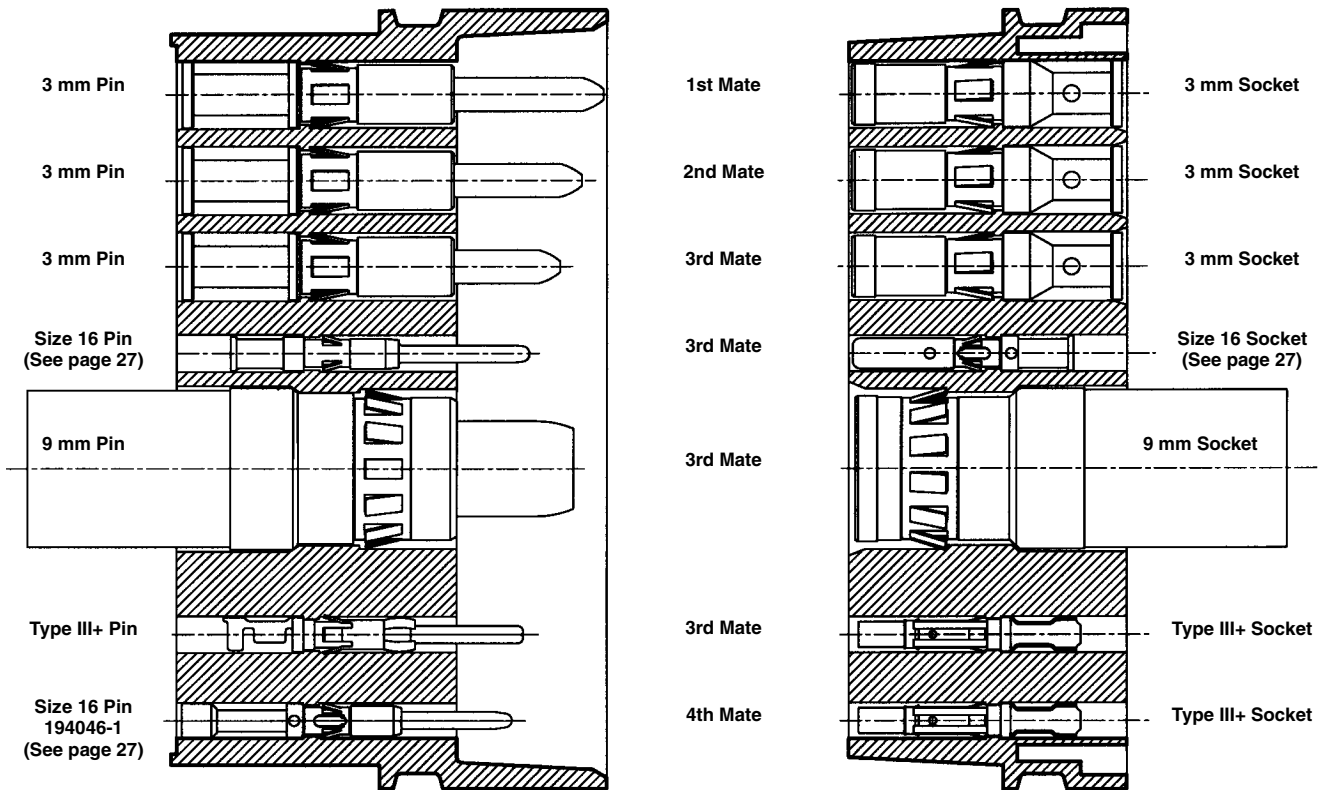

Fork Connectors

Thread Mount Fork

The Thread Mount Fork was developed to mount onto a plate or bus bar designed and fabricated by the customer. The Fork is rated at 84 amps (Upper Tolerance Limit) and accepts a .087 thick blade or circuit board. The anti-rotation pin is in place to help prevent the Fork from rotating while tightening the screw.

Material

- Fork** — Zinc Al Alloy
- Louvertac Bands** — Copper Alloy
- Screw** — Steel

Finish

- Fork** — Silver
- Louvertac Bands** — Silver
- Screw** — Zinc

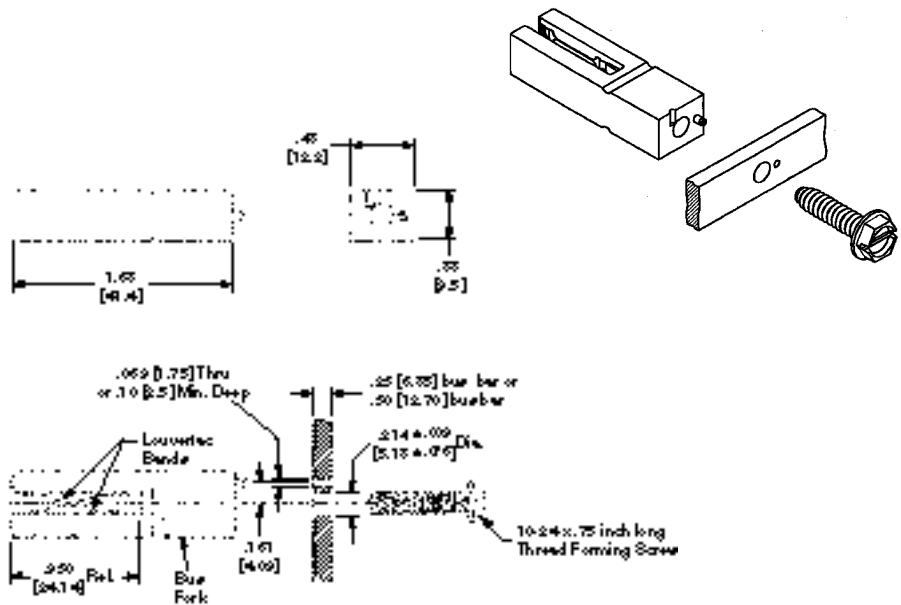

Part Number 194257-1

Right-Angle Thread Mount Fork

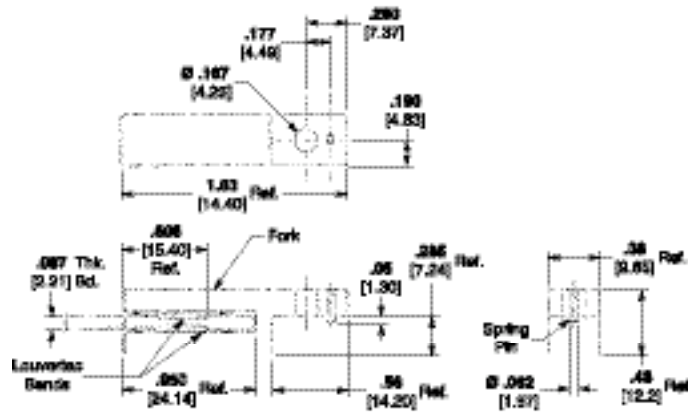
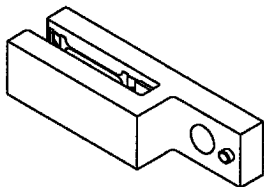

Part Number 194305-1

Material

- Fork** — Zinc Al Alloy
- Louvertac Bands** — Copper Alloy
- Spring Pin** — Stainless Steel

Finish

- Fork** — Silver
- Louvertac Bands** — Silver

Louvertac Strip, Torsional Louver Type

The Torsional Louver Type Band was designed as an electrical interface that allows the transfer of high current and a more generous tolerance between mating surfaces. A strip can be sized with scissors in an on-site installation. They are available for use in flat and circular applications. A male band is used on the outside diameter of a pin. The female band is used on the inside diameter of a socket.

Material — Beryllium Copper

Finish — See Tables

LAO .092 [2.27] Louver Height

Tooth Angle — 15°
Minimum Diameter — 1.75 inches

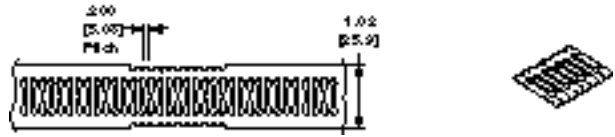

Part No.	Application	Material Thickness	Suggested Current Limit per inch	Finish
192000-2	Flat or Female	.006 .15	150	Silver
192000-9	Flat or Female	.010 .25	250	Silver
192001-4	Flat or Male	.006 .15	150	Silver

LAOG Louver Height — See Table

Tooth Angle — 45°
Minimum Diameter — 1.75 inches

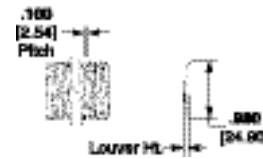

Part No.	Application	Material Thickness	Suggested Current Limit per inch	Louver Height	Finish
192002-1	Flat or Female	.006 .15	300	.105 2.67	Unplated
192002-2	Flat or Female	.006 .15	300	.105 2.67	Silver
192002-3	Flat or Female	.010 .25	500	.110 2.79	Unplated

LAIA .050 [1.27] Louver Height

Tooth Angle — See Table
Minimum Diameter — 1½ inches

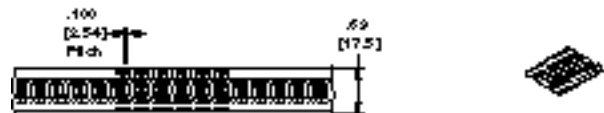

Part No.	Application	Material Thickness	Suggested Current Limit per inch	Tooth Angle	Finish
192004-4	Flat or Female	.004 .10	150	15°	Silver
192004-6	Flat or Female	.004 .10	150	45°	Silver
192004-8	Flat or Female	.006 .15	250	15°	Silver
1-192004-1	Flat or Female	.006 .15	250	15°	Gold
1-192004-4	Flat or Female	.006 .15	250	45°	Silver
192007-7	Flat or Male	.006 .15	250	15°	Silver
192008-1	Flat or Male	.004 .10	150	45°	Silver

Notes: 1. Product will be sold by the foot except where length is specified.
2. Suggested current limits are application dependent.
3. Additional sizes are available upon request.

Louvertac Strip, Bridge Louver Type

The Bridge Louver Type Band was designed to transfer high currents in very small spaces. A strip can be sized with scissors in an on-site installation. They are available for use in flat and circular applications. A male band is used on the outside diameter of a pin. The female band is used on the inside diameter of a socket.

Material—Beryllium Copper

LAIH
.034 [.86] Louver Height

Minimum Diameter — 1 inch
Suggested Current Limit
Per Inch — 150 Amps
Material Thickness — .006 [.15]

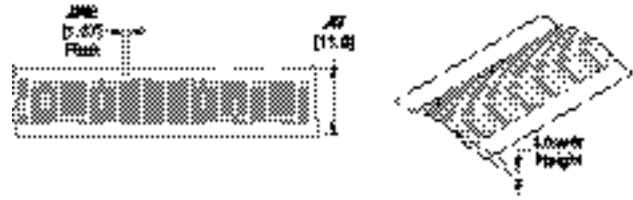

Part No.	Application	Finish
192038-6	Female	Silver
192039-5	Male	Silver

LAIV
.026 [.66] Louver Height

Minimum Diameter — ¾ inch
Suggested Current Limit
Per Inch — 150 Amps
Material Thickness — See Table

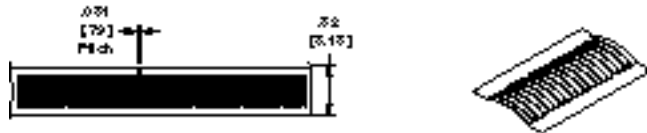

Part No.	Application	Finish	Material Thickness
1-192041-2	Female	Silver	.006 .15
192042-5	Male	Silver	.006 .15
192048-2	Male	Gold	.004 .10

LAV
.022 [.56] Louver Height

Minimum Diameter — ¾ inch
Suggested Current Limit
Per Inch — 120 Amps
Material Thickness — See Table

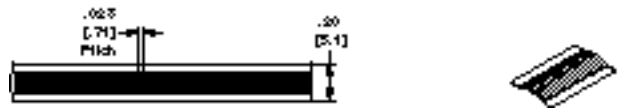

Part No.	Application	Finish	Material Thickness
1-192044-9	Female	Silver	.005 .13
192045-5	Male	Silver	.005 .13
192045-2	Male	Gold	.004 .10
1-192045-2	Male	Gold	.004 .10

- Notes:** 1. Product will be sold by the foot except where length is specified.
2. Suggested current limits are application dependent.
3. Additional sizes are available upon request.

Preformed Female Louvertac Bands

Female Torsional Formed Type

LA1A/LA1B .050 [1.27] Louver Height

Material — Beryllium Copper

Finish — See Table

Tooth Angle — See Table

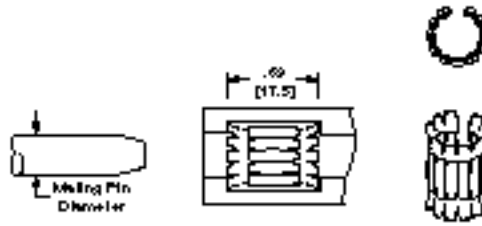

Louvertac Bands can be manufactured as preformed diameters. This will allow the insertion of the band into a socket.

The diameter indicated is the mating pin diameter that will be inserted into the socket assembly.

Consult Product Engineering for mounting details.

Part No.	Mating Pin Dia.	Material Thickness	Suggested Current Limit (A)	Finish	Tooth Angle	Band Type
4-192013-3	.312 [7.92]	.004 [.10]	150	Silver	15°	LA1A
4-192013-5	.312 [7.92]	.006 [.15]	250	Silver	15°	LA1A
5-192013-1	.355 [9.01]	.006 [.15]	275	Gold	15°	LA1A
5-192013-4	.375 [9.53]	.006 [.15]	300	Silver	15°	LA1A
5-192013-5	.394 [10.00]	.006 [.15]	325	Silver	15°	LA1A
5-192013-8	.434 [11.02]	.006 [.15]	350	Gold	15°	LA1A
5-192013-9	.437 [11.10]	.006 [.15]	350	Silver	15°	LA1A
6-192013-7	.472 [11.99]	.006 [.15]	375	Silver	15°	LA1A
6-192013-9	.472 [11.99]	.008 [.20]	375	Silver	15°	LA1A
7-192013-1	.500 [12.70]	.006 [.15]	400	Silver	15°	LA1A
7-192013-6	.551 [14.00]	.006 [.15]	450	Silver	15°	LA1A
8-192013-2	.625 [15.88]	.006 [.15]	500	Silver	15°	LA1A
8-192013-6	.625 [15.88]	.008 [.20]	475	Silver	15°	LA1A
8-192013-9	.685 [17.40]	.006 [.15]	550	Silver	15°	LA1A
9-192013-6	.750 [19.05]	.006 [.15]	600	Silver	15°	LA1A
192033-3	.750 [19.05]	.008 [.20]	600	Silver	15°	LA1A
1-192033-9	.875 [22.22]	.006 [.15]	675	Gold	15°	LA1A
2-192033-0	.875 [22.22]	.006 [.15]	700	Silver	15°	LA1A
2-192033-6	1.000 [25.40]	.006 [.15]	775	Silver	15°	LA1A
3-192033-4	1.250 [31.75]	.006 [.15]	975	Silver	15°	LA1A
5-192033-2	1.000 [25.40]	.008 [.20]	800	Silver	15°	LA1A
3-192013-8	1.187 [30.10]	.006 [.15]	950	Silver	45°	LA1B
5-192033-0	.812 [20.62]	.008 [.20]	625	Silver	45°	LA1B

Notes: 1. Suggested current limits are application dependent.
2. Additional sizes are available upon request.

Preformed Female Louvertac Bands (Continued)

Female Bridge Formed Type LAIII through LAVI

Material — Beryllium Copper

Finish — See Table

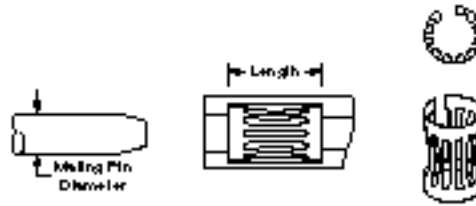

Part No.	Mating Pin Dia.	Length	Material Thickness	Suggested Current Limit (A)	Finish	Band Type
1-192038-9	.125 [3.18]	.47 [11.9]	.004 [.10]	40	Nickel	LAIII
2-192038-8	.197 [5.00]	.47 [11.9]	.006 [.15]	90	Gold	LAIII
3-192038-7	.236 [6.00]	.47 [11.9]	.006 [.15]	100	Gold	LAIII
4-192038-0	.236 [6.00]	.47 [11.9]	.008 [.20]	120	Gold	LAIII
4-192038-1	.236 [6.00]	.47 [11.9]	.008 [.20]	120	Gold	LAIII
4-192038-8	.250 [6.35]	.47 [11.9]	.006 [.15]	110	Silver	LAIII
4-192038-9	.250 [6.35]	.47 [11.9]	.006 [.15]	110	Gold	LAIII
5-192038-4	.250 [6.35]	.47 [11.9]	.008 [.20]	125	Gold	LAIII
6-192038-0	.280 [7.11]	.47 [11.9]	.008 [.20]	165	Silver	LAIII
6-192038-1	.280 [7.11]	.47 [11.9]	.008 [.20]	125	Gold	LAIII
6-192038-2	.250 [6.35]	.47 [11.9]	.006 [.15]	125	Unplated	LAIII
6-192038-5	.315 [8.00]	.47 [11.9]	.008 [.20]	185	Silver	LAIII
6-192038-6	.315 [8.00]	.47 [11.9]	.008 [.20]	185	Gold	LAIII
7-192038-7	.394 [10.00]	.47 [11.9]	.008 [.20]	250	Silver	LAIII
8-192038-1	.437 [11.10]	.47 [11.9]	.008 [.20]	270	Silver	LAIII
8-192038-6	.472 [11.99]	.47 [11.9]	.008 [.20]	300	Silver	LAIII
9-192038-4	.500 [12.70]	.47 [11.9]	.008 [.20]	300	Tin	LAIII
192040-8	.375 [9.53]	.47 [11.9]	.008 [.20]	200	Gold	LAIII
2-192040-7	.250 [6.35]	.47 [11.9]	.006 [.15]	110	Gold	LAIII
2-192041-9	.025 [0.64]	.32 [8.13]	.005 [.13]	15	Gold	LAIV
4-192041-0	.062 [1.57]	.32 [8.13]	.006 [.15]	25	Silver	LAIV
4-192041-1	.062 [1.57]	.32 [8.13]	.006 [.15]	25	Gold	LAIV
4-192041-4	.080 [2.03]	.32 [8.13]	.006 [.15]	35	Gold	LAIV
5-192041-0	.093 [2.36]	.32 [8.13]	.005 [.13]	40	Gold	LAIV
5-192041-9	.100 [2.54]	.32 [8.13]	.006 [.15]	50	Gold	LAIV
6-192041-9	.125 [3.18]	.32 [8.13]	.006 [.15]	60	Gold	LAIV
7-192041-4	.157 [4.00]	.32 [8.13]	.006 [.15]	65	Gold	LAIV
7-192041-7	.157 [4.00]	.32 [8.13]	.006 [.15]	65	Silver	LAIV
7-192041-8	.157 [4.00]	.32 [8.13]	.006 [.15]	65	Gold	LAIV
8-192041-4	.157 [4.00]	.32 [8.13]	.008 [.20]	75	Gold	LAIV
8-192041-9	.173 [4.39]	.32 [8.13]	.006 [.15]	70	Gold	LAIV
192043-6	.218 [5.54]	.32 [8.13]	.006 [.15]	95	Silver	LAIV
1-192043-5	.254 [6.45]	.32 [8.13]	.006 [.15]	110	Silver	LAIV
1-192043-6	.250 [6.35]	.32 [8.13]	.006 [.15]	120	Gold	LAIV
2-192043-0	.280 [7.11]	.32 [8.13]	.006 [.15]	130	Gold	LAIV
2-192043-7	.315 [8.00]	.32 [8.13]	.006 [.15]	165	Silver	LAIV
4-192043-5	.375 [9.53]	.32 [8.13]	.006 [.15]	175	Gold	LAIV
5-192043-0	.375 [9.50]	.32 [8.13]	.007 [.18]	175	Tin	LAIV
6-192043-7	.602 [15.30]	.32 [8.13]	.006 [.15]	285	Gold	LAIV
7-192043-2	.125 [3.18]	.32 [8.13]	.006 [.15]	60	Silver	LAIV
9-192043-3	.157 [4.00]	.32 [8.13]	.006 [.15]	65	Silver	LAIV
9-192043-6	.725 [18.40]	.32 [8.13]	.006 [.15]	350	Silver	LAIV
4-192044-1	.030 [0.76]	.20 [5.10]	.005 [.13]	13	Gold	LAV
4-192044-2	.030 [0.76]	.20 [5.10]	.005 [.13]	11	Unplated	LAV
4-192044-4	.055 [1.40]	.20 [5.10]	.005 [.13]	20	Gold	LAV
4-192044-7	.060 [1.54]	.20 [5.10]	.004 [.10]	22	Gold	LAV
5-192044-6	.062 [1.57]	.20 [5.10]	.005 [.13]	25	Gold	LAV
5-192044-8	.065 [1.65]	.20 [5.10]	.005 [.13]	23	Unplated	LAV
6-192044-0	.080 [2.03]	.20 [5.10]	.004 [.10]	30	Silver	LAV
6-192044-4	.080 [2.03]	.20 [5.10]	.005 [.13]	30	Gold	LAV

Notes: 1. Suggested current limits are application dependent.
2. Additional sizes are available upon request.

Preformed Female Louvertac Bands (Continued)

Female Bridge Formed Type

LAIII through LAVI

(Continued)

Material — Beryllium Copper

Finish — See Table

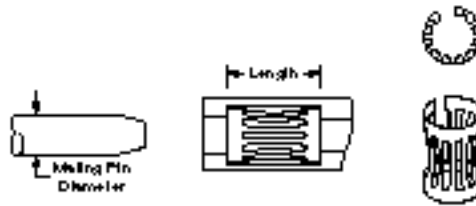

Part No.	Mating Pin Dia.	Length	Material Thickness	Suggested Current Limit (A)	Finish	Band Type
6-192044-6	.080 [2.03]	.20 [5.10]	.008 [.20]	30	Gold	LAV
7-192044-1	.093 [2.36]	.20 [5.10]	.005 [.13]	35	Gold	LAV
8-192044-1	.125 [3.18]	.20 [5.10]	.004 [.10]	45	Gold	LAV
8-192044-3	.125 [3.18]	.20 [5.10]	.005 [.13]	45	Silver	LAV
8-192044-4	.125 [3.18]	.20 [5.10]	.005 [.13]	45	Gold	LAV
8-192044-7	.125 [3.18]	.20 [5.10]	.005 [.13]	45	Unplated	LAV
192046-6	.172 [4.40]	.20 [5.10]	.006 [.15]	65	Gold	LAV
1-192046-6	.225 [5.70]	.20 [5.10]	.006 [.15]	85	Gold	LAV
1-192046-9	.250 [6.35]	.20 [5.10]	.006 [.15]	110	Gold	LAV
2-192046-0	.250 [6.30]	.20 [5.10]	.006 [.15]	95	Tin	LAV
3-192046-0	.400 [10.2]	.20 [5.10]	.005 [.13]	150	Gold	LAV
5-192046-0	.750 [19.0]	.20 [5.10]	.005 [.13]	285	Gold	LAV
5-192046-9	.134 [3.40]	.20 [5.10]	.006 [.15]	50	Gold	LAV
1-192047-4	.040 [1.00]	.10 [2.54]	.004 [.10]	15	Gold	LAVI
1-192047-9	.062 [1.60]	.10 [2.54]	.004 [.10]	22	Gold	LAVI
3-192047-7	.125 [3.20]	.10 [2.54]	.004 [.10]	45	Gold	LAVI
5-192047-1	.256 [6.50]	.10 [2.54]	.004 [.10]	95	Gold	LAVI
5-192047-3	.272 [6.90]	.10 [2.54]	.004 [.10]	65	Gold	LAVI
7-192047-5	.256 [6.50]	.10 [2.54]	.004 [.10]	95	Unplated	LAVI

Preformed Male Louvertac Bands

Male Torsional Formed Type

LA1AS/LA1BS

Material — Beryllium Copper

Finish — See Table

Tooth Angle — See Table

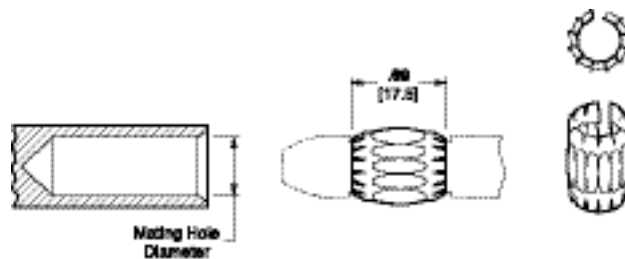

Louvertac Bands can be formed into a "male" shape for use on a pin. Selection begins with the amperage requirement and then the mating hole diameter.

Consult Product Engineering for mounting details.

Part No.	Mating Hole Dia.	Material Thickness	Suggested Current Limit (A)	Finish	Tooth Angle	Band Type
192007-9	.312 [7.92]	.006 [.15]	200	Silver	15°	LA1AS
1-192007-9	.620 [15.7]	.006 [.15]	425	Silver	15°	LA1AS
2-192007-5	.750 [19.0]	.008 [.20]	550	Silver	15°	LA1AS
3-192007-1	1.000 [25.4]	.006 [.15]	750	Silver	15°	LA1AS
192008-6	.500 [12.7]	.006 [.15]	350	Silver	45°	LA1BS
1-192008-3	.750 [19.0]	.008 [.20]	550	Silver	45°	LA1BS
1-192008-5	.781 [19.8]	.006 [.15]	575	Silver	45°	LA1BS
2-192008-1	.875 [22.22]	.008 [.20]	650	Silver	45°	LA1BS
3-192008-4	1.197 [30.4]	.008 [.20]	900	Silver	45°	LA1BS
4-192008-2	1.450 [36.8]	.006 [.15]	1100	Silver	45°	LA1BS

Notes: 1. Suggested current limits are application dependent.
2. Additional sizes are available upon request.

Preformed Male Louvertac Bands (Continued)

Male Bridge Formed Type LAIIS through LAVIS

Material — Beryllium Copper

Finish — See Table

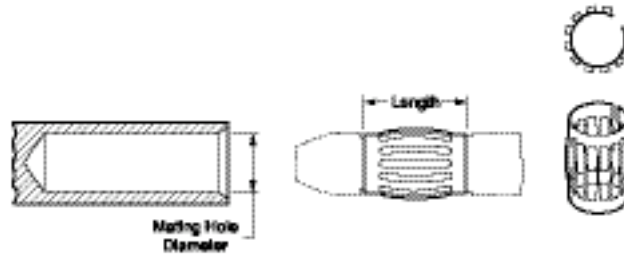

Part No.	Mating Hole Dia.	Length	Material Thickness	Suggested Current Limit (A)	Finish	Band Type
1-192039-7	.157 [4.0]	.470 [11.9]	.008 [.20]	75	Gold	LAIIS
2-192039-1	.250 [6.35]	.470 [11.9]	.008 [.20]	130	Silver	LAIIS
2-192039-3	.248 [6.3]	.470 [11.9]	.008 [.20]	130	Silver	LAIIS
2-192039-7	.311 [7.9]	.470 [11.9]	.008 [.20]	175	Unplated	LAIIS
2-192039-9	.311 [7.9]	.470 [11.9]	.008 [.20]	175	Silver	LAIIS
3-192039-0	.311 [7.9]	.470 [11.9]	.008 [.20]	175	Gold	LAIIS
5-192039-3	.236 [6.0]	.470 [11.9]	.008 [.20]	120	Nickel	LAIIS
5-192039-4	.157 [4.0]	.470 [11.9]	.008 [.20]	75	Nickel	LAIIS
1-192042-5	.080 [2.0]	.320 [8.13]	.005 [.12]	30	Nickel	LAVIS
2-192042-5	.157 [4.0]	.320 [8.13]	.006 [.15]	65	Unplated	LAVIS
2-192042-8	.157 [3.99]	.320 [8.13]	.006 [.15]	60	Gold	LAVIS
4-192042-8	.500 [1.27]	.320 [8.13]	.005 [.12]	235	Unplated	LAVIS
6-192042-6	.368 [9.38]	.320 [8.13]	.004 [.10]	170	Unplated	LAVIS
6-192042-7	.375 [9.53]	.320 [8.13]	.006 [.15]	175	Tin	LAVIS
6-192042-8	.375 [9.53]	.320 [8.13]	.006 [.15]	175	Gold	LAVIS
2-192045-3	.250 [6.35]	.200 [5.10]	.006 [.15]	95	Gold	LAVIS
192048-6	.051 [1.3]	.100 [2.54]	.004 [.10]	17	Gold	LAVIS
1-192048-1	.127 [3.23]	.100 [2.54]	.004 [.10]	22	Gold	LAVIS
2-192048-4	.156 [3.96]	.100 [2.54]	.004 [.10]	65	Gold	LAVIS

Notes: 1. Suggested current limits are application dependent.
2. Additional sizes are available upon request.

Part Number Index

Note: This index lists all cataloged parts by base no. only. Complete part nos. (with prefixes and/or suffixes) are shown on the page(s) indicated.

Part No.	Page	Part No.	Page	Part No.	Page
46751	7	192059	4	194245	26
46765	6, 7	192085	4	194251	25
46766	6, 7, 22	192129	4	194252	25
46767	7	192161	4	194257	30
58382	9	192211	4	194260	10
66098	26	192244	4	194264	12, 27
66099	26	192271	4	194269	10
66100	26	192293	4	194278	20
66101	26	192447	5	194279	20
66102	26	193457	8	194280	19
66103	26	193458	8	194281	19
66104	26	193534	8	194282	21
66105	26	193535	8	194283	21
66106	26	193642	8	194298	20
66107	26	193643	8	194299	20
66108	26	193673	7	194305	30
66109	26	193678	7	194610	10
66331	26	193796	9	200893	25, 26
66332	26	193797	9	206036	11
66358	26	193814	8	206037	11
66359	26	193837	6	206060	12
66360	26	193839	9	207152	12
66361	26	193841	9	207153	12
66393	26	193842	9	213426	8
66394	26	193844	12, 27, 29	213427	8
66399	26	193846	12, 27, 29	213499	8
66400	26	193990	11	213500	8
66405	26	193991	11	224155	11
66406	26	194002	10	305183	8, 12, 25, 26, 27
66424	26	194009	10	318813	6, 7, 8
66425	26	194010	10	356114	8, 9, 11
66428	26	194012	10	356119	11
66429	26	194013	10	356335	24, 25, 26
66471	25	194014	10	356336	8
66473	25	194017	10	356337	9
69099	6, 7, 22	194018	10	601967	12, 27
69120	6, 7, 22	194032	24	662725	22, 23
69133	6, 7	194037	22	679916	6, 7
69134	6, 7	194041	22	679917	6, 7
91002	26	194046	27, 29	679918	6, 7
91067	13	194049	23	770016	9
126195	13	194050	23	770017	9
192000	31	194069	15	770018	9
192001	31	194070	15	770019	9
192002	31	194081	13	770020	9
192004	31	194083	13	770021	9
192007	31, 35	194096	10	770022	9
192008	31, 35	194182	16	770023	9
192013	33	194183	16	770024	9
192033	33	194189	24, 26	770025	9
192038	32, 34	194196	17	770026	9
192039	32, 36	194197	17	770027	9
192040	34	194210	9	770028	9
192041	32, 34	194211	9	770029	9
192042	32, 36	194212	9	770030	9
192043	34	194213	9	796298	19
192044	32, 34, 35	194214	9	796299	19
192045	32, 36	194215	9	796764	12
192046	35	194234	10	796964	12, 27
192047	35	194242	18	796966	12, 27
192048	32, 36	194243	18		

Engineering Notes

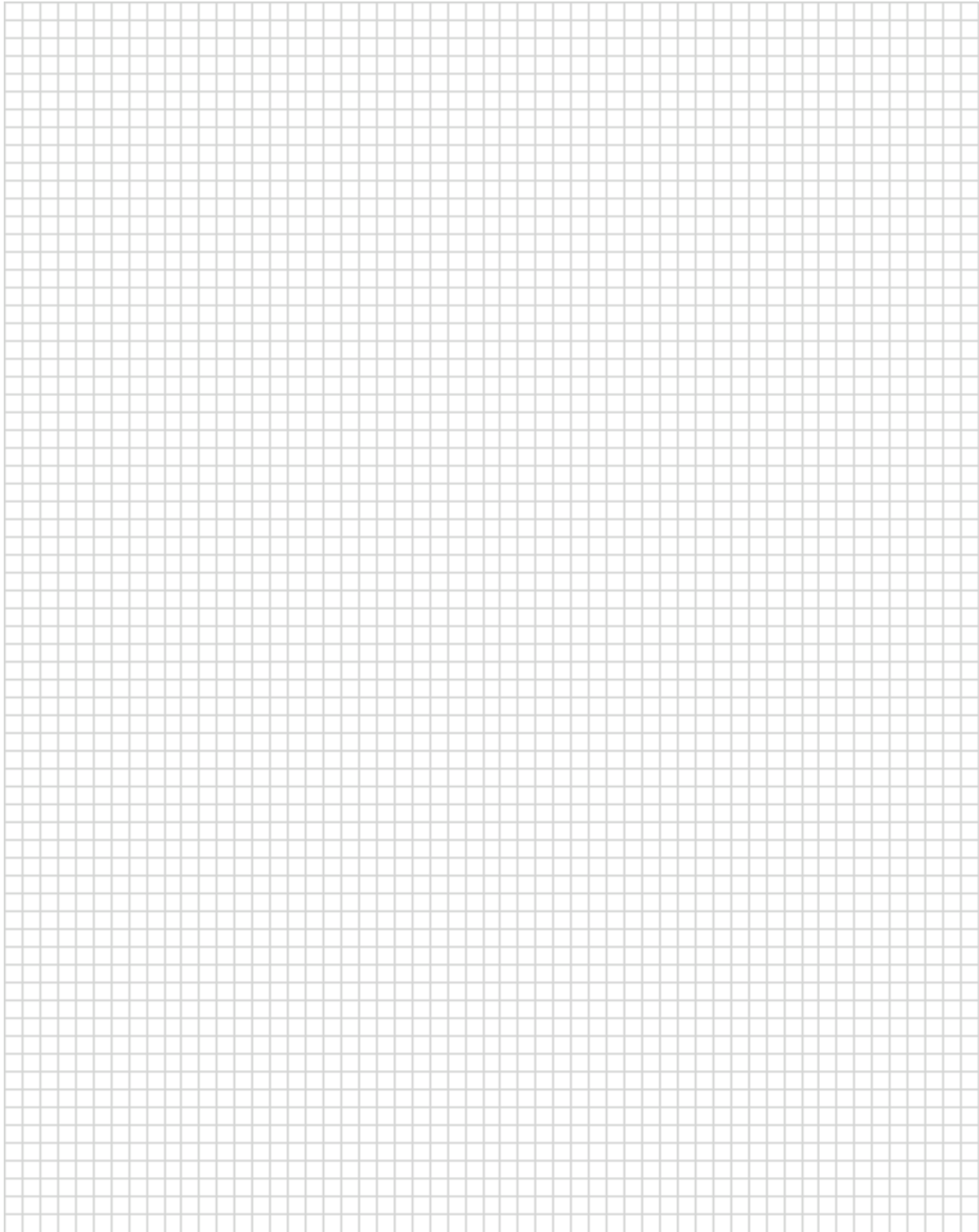

tyco

Electronics

TYCO ELECTRONICS CORPORATION
HARRISBURG, PA 17105

AMP

