

D-3000 Series (Wire-to-Board, Wire-to-Panel and Wire-to-Wire)

List of Products by Application

Used for both signal circuit and power/power supply circuit applications.

Able to carry 15A max. of current per position and are available in a full range of connector configurations including wire-to-wire, panel-mounting, free hanging, and horizontal and vertical wire-to-board mounting.

D-3000 Series

**D-3100S
Standard 1-Row Type**

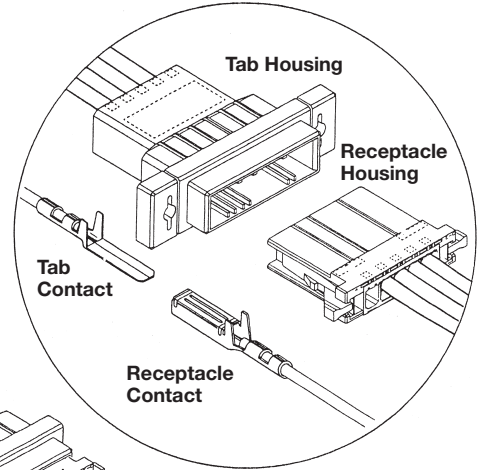

D-3100S Free-Hanging Type

**D-3100M
Standard Modular Type**

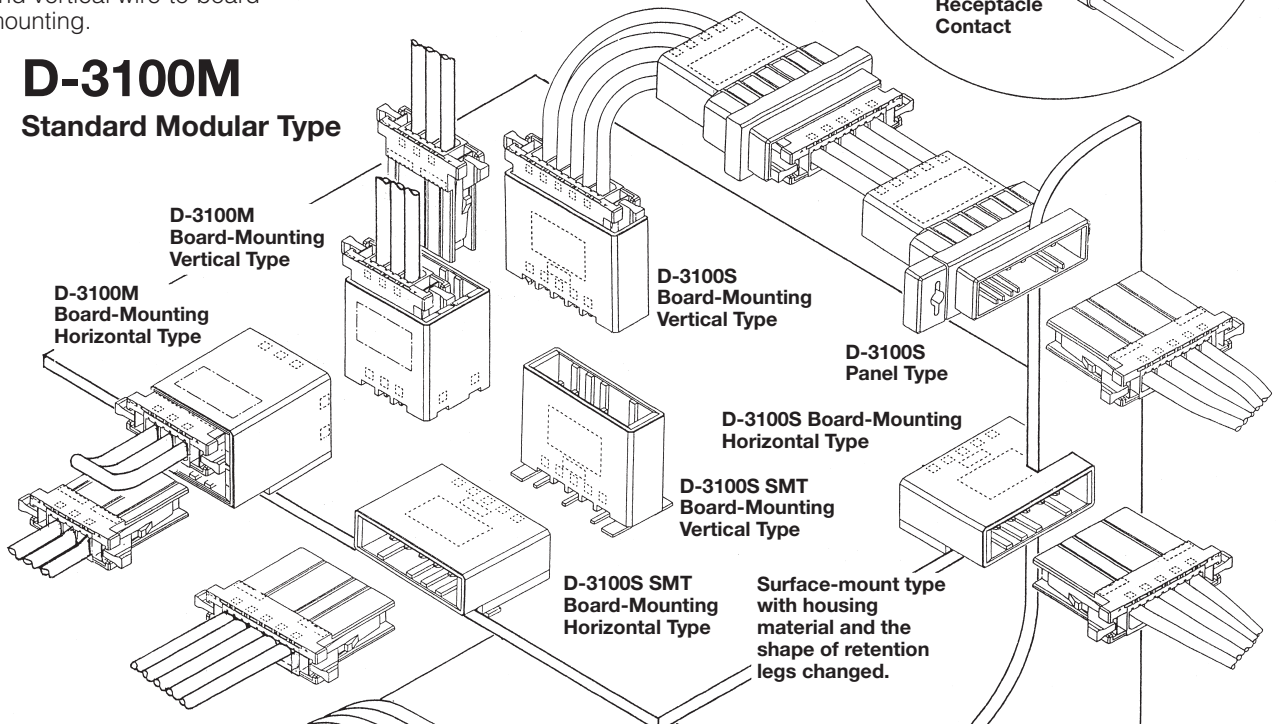

D-3100M Board-Mounting Vertical Type

D-3100M Board-Mounting Horizontal Type

D-3100S Board-Mounting Vertical Type

D-3100S Panel Type

D-3100S Board-Mounting Horizontal Type

D-3100S SMT Board-Mounting Vertical Type

D-3100S SMT Board-Mounting Horizontal Type

Surface-mount type with housing material and the shape of retention legs changed.

D-3100D Board-Mounting Vertical Type

D-3100D Free-Hanging Type

D-3100D Panel Type

All connector configurations available as with the standard one-row type line.

**D-3100D
Standard 2-Row Type**

D-3000 Series (Continued)

List of Products by Application (Continued)

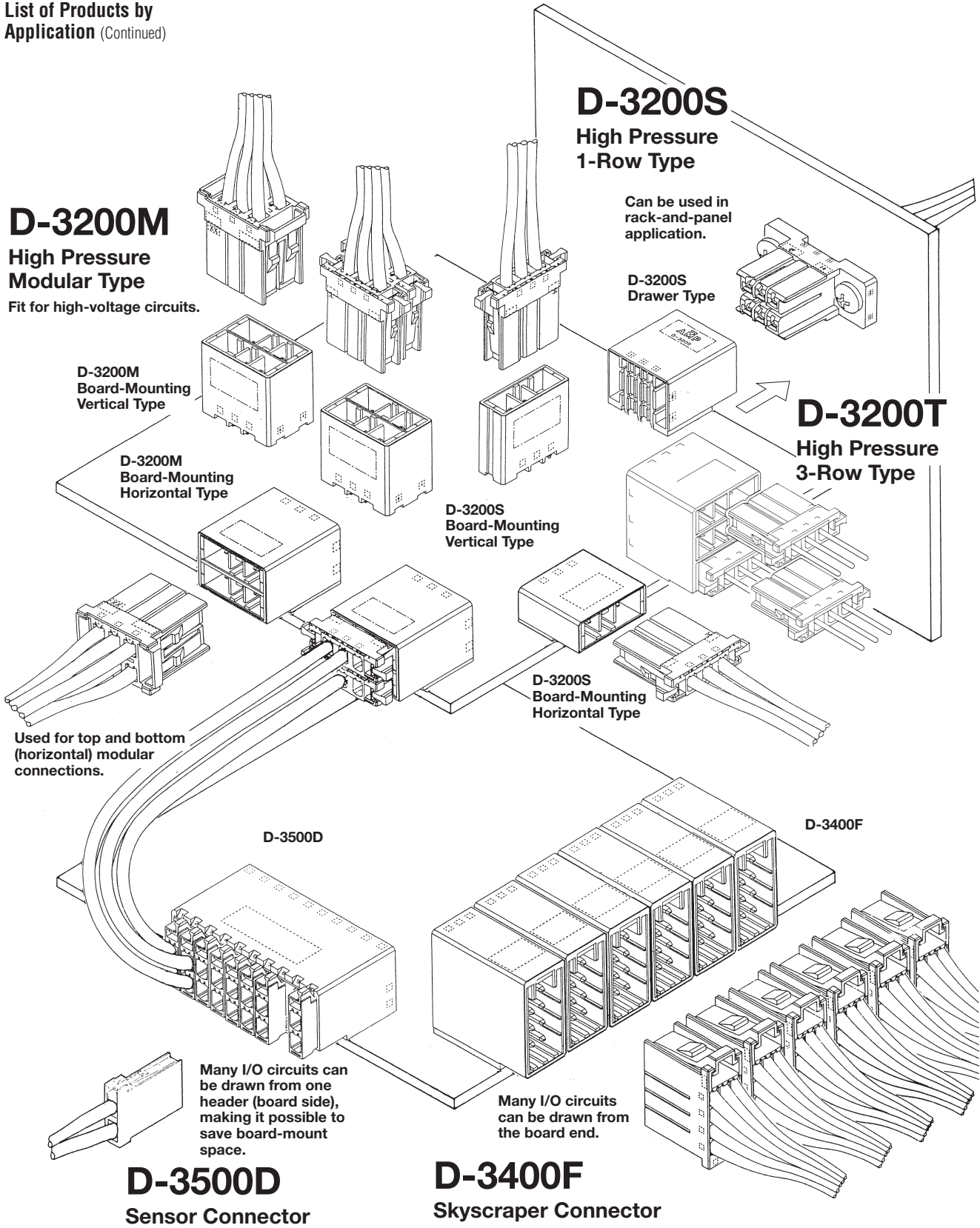

D-3000 Series

D-3000 Series (Continued)

Performance Specifications

Item	Pitch	150mil (3.81mm)	200mil (5.08mm)
	Voltage Rating		250 V
Current Rating		1-position : 15A 3-position : 12A 6-position : 10A 16-position : 8A (when using #16 AWG wire)	
Contact Resistance		10mΩ max.	
Dielectric Withstanding Voltage		1,500 V	2,200 V (1 minute)
Operating Temperature		-55°~+105°C	

Generally, the current value of connector is shown as per position. The current rating of this product is 15A as shown in the table. Note that in all circumstances it is the value per position. As the number of positions increases, this value decreases. This decrease can be calculated from the table and the current curve shown in the graph below.

Example:

- With a 6-position connector, 10A of current per position or a total of 60A (max) can be carried as shown in the table.
- With a 10-position connector, 8.5A of current per position or a total of 85A (max) can be carried as indicated by dotted lines in the graph below.

*When connectors are used singly.

Number of Positions vs Current Curve (reference)

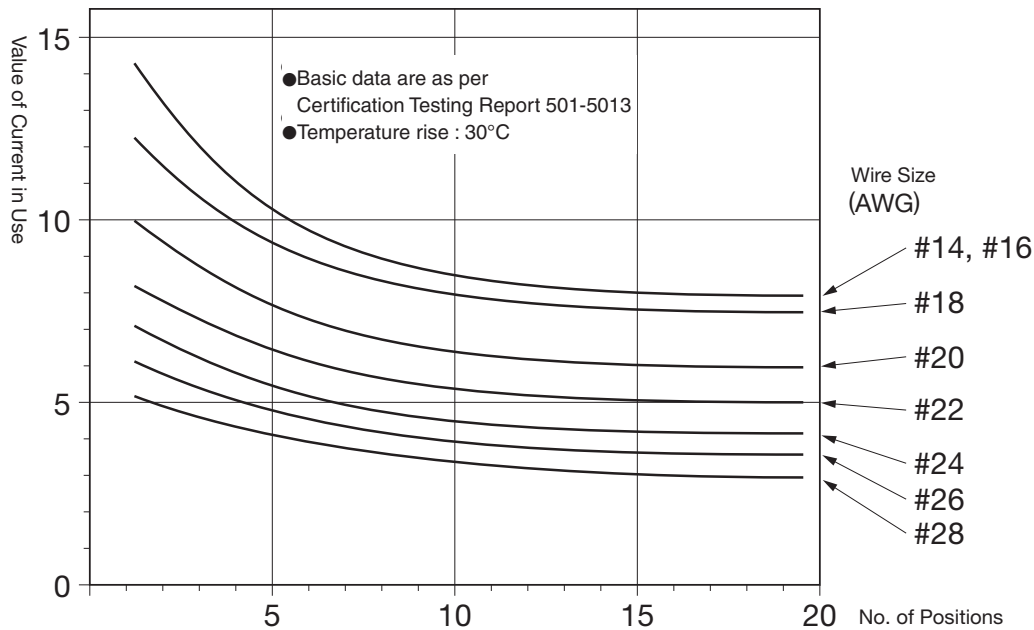

Material and Finish

Description	Material	Finish
Receptacle contact Tab contact	Copper alloy	Bright tin plating and gold plating with underplated nickel (1.27μm)
Tab post	Copper alloy	Tin plating and gold plating with underplated nickel (1.27μm)
Housing	UL94V-0 rated glass filled polyester (PBT) and PPS (SMT Type), black color.	

D-3000 Series

D-3000 Series (Continued)

Performance Specifications

(Continued)

Specifications and Instruction Sheets

Specifications and Instruction Sheets

Product Specification	108-5349
Testing Report	501-5013
Application Specification	114-5148
Instruction Sheet-Extraction Tool	411-5726

Instruction Sheet-Hand Tools

Instruction Sheet-Manual Tools

Tool No.	IS No.
91565-1	
91559-1	
91558-1	408-8547
91560-1	
19561-1	

*Remember to obtain Instruction Sheets when you choose to use these tools.

D-3000 Series

Safety Specifications

The safety specifications listed below are approved on specific part numbers. Contact our Technical Support to check if the part numbers you use are approved or not. Keep in mind that there are instances where values differ from those given by Tyco Electronics Specifications.

Series	D-3100, D-3400 Series (3.81mm pitch)			D-3200, D-3500 Series (5.08mm pitch)		
	Voltage Rating	Current Rating	Temperature Rating	Voltage Rating	Current Rating	Temperature Rating
Specifications 108-5349	250 V	See page 36	-55° to +105°C	600 V (Single conn.)	See page 36	-55° to +105°C
UL File No. E28476 (Recognized Component)	Determined by requirements of equipment in use.	Determined by requirements of equipment in use.	—	Determined by requirements of equipment in use.	Determined by requirements of equipment in use.	—
CSA Report No. LR7189	250 V	8A max.	—	250 V	8A max.	—
TÜV License No. R9151488 (VDE0627) IP Protection IP-00 Overvoltage Classification(II) Number of Repeated Insertions and Withdrawals 50	250 V	#28 AWG=2A #26 AWG=3A #24 AWG=3A #22 AWG=4A #20 AWG=5A #18 AWG=6A #16 AWG=8A #14 AWG=8A	-20° to +105°C	500 V	#28 AWG=2A #26 AWG=3A #24 AWG=3A #22 AWG=4A #20 AWG=5A #18 AWG=6A #16 AWG=8A #14 AWG=8A	-20° to +105°C

D-3000 Series (Continued)

D-3 Contact and Application Tooling

Crimp Type

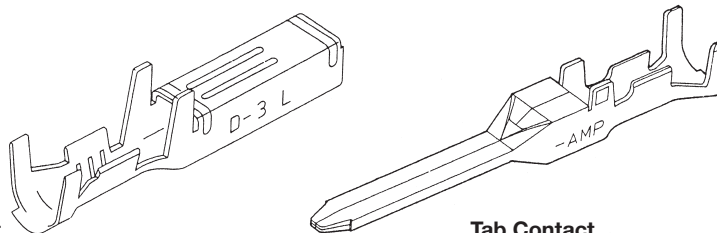

Receptacle Contact
(Used on Receptacle Housing)

Tab Contact
(Used on Tab Housing)

Wire Range		Wire Ins. Diameter	Wire Range Mark	Contact Part Number ¹			Application Tooling Part Number		
				Receptacle Contact		Tab Contact	Mini-Applicator*	Hand Tool	
AWG	mm ²			Standard contact (Only -2 & -3 available)	High contact (pressure -2, -3, & -5 available)				
28	0.08	0.8~1.2	S	ST.	175194-□	1-175194-□	175284-□	**	—
26	0.12			LP.	175216-□	1-175216-□	175287-□	—	91565-1
24	0.20	1.2~1.6	M	ST.	175195-□	1-175195-□	175285-□	**	—
22	0.30			LP.	175217-□	1-175217-□	175288-□	—	91559-1
20	0.50	1.7~2.6	L	ST.	175196-□	1-175196-□	175286-□	**	—
18	0.85			LP.	175218-□	1-175218-□	175289-□	—	91558-1
16	1.25	2.2~2.8	2L	ST.	917484-□	1-917484-□	917485-□	**	—
14	2.20			LP.	917511-□	1-917511-□	917512-□	—	91560-1
16	1.25	3.1~3.3	3L	ST.	353715-□	1-353715-□	353716-□	**	—
14	2.20			LP.	353717-□	1-353717-□	353718-□	—	91561-1

¹ Enter the following plating code in Part Number suffix-□ :

- 2 = 0.38µm thick gold plating
- 3 = 0.76µm thick gold plating
- 5 = Tin plating

Note: Solder-type Contact: We do not manufacture solder-type contacts for this specific application.

* Strip Form contacts are for use with Mini-Applicators (automachines) and Loose-Piece contacts are for Hand Tools.

** Mini-Applicators are for use with automachines. (See page 40. For Part Numbers, contact Technical Support.)

Hand Tools



Uses	For General Production
Can it be used for repairing?	Yes
Approximately how many cycles of crimping can be performed?	50,000
What is Minimum Order Quantity?	1

D-3000 Series (Continued)

Application Tooling

(Continued)

Hand Tool

This hand tool is designed to be capable of handling most Factory Automation (FA) related crimping operations by a single tool in order to simplify harness fabrications suited to the specific needs of FA market. The equipment forming the nucleus of the FA system includes PCs, CNCs, servodrivers and servomotors. And the wire used in connecting this equipment ranges in wire size from #26-20 AWG which applies to signal circuits to #18-16 AWG which is for power circuits (See Sketch below).

Crimping Range A, B, and C are for explanation purposes only and are not marked on the tool body.

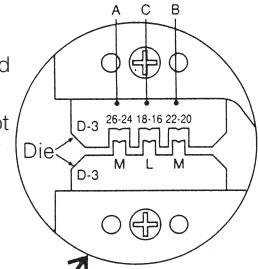

For right-handed use
Hand Tool P/N : 58571-1
Die Set P/N : 58571-2

The frame of right-handed tool has the same configuration as that of Economy Type (II) and PRO-CRIMPER II Hand Tool (See PRO-CRIMPER Hand Tool Catalog). So die sets are interchangeable.

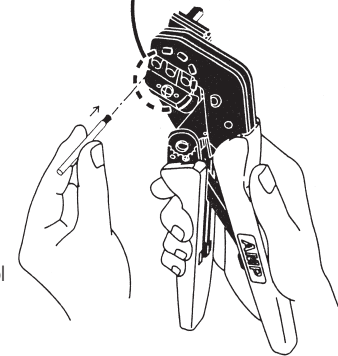

D-3000 Series

Servomotor / Servodriver Typical Application

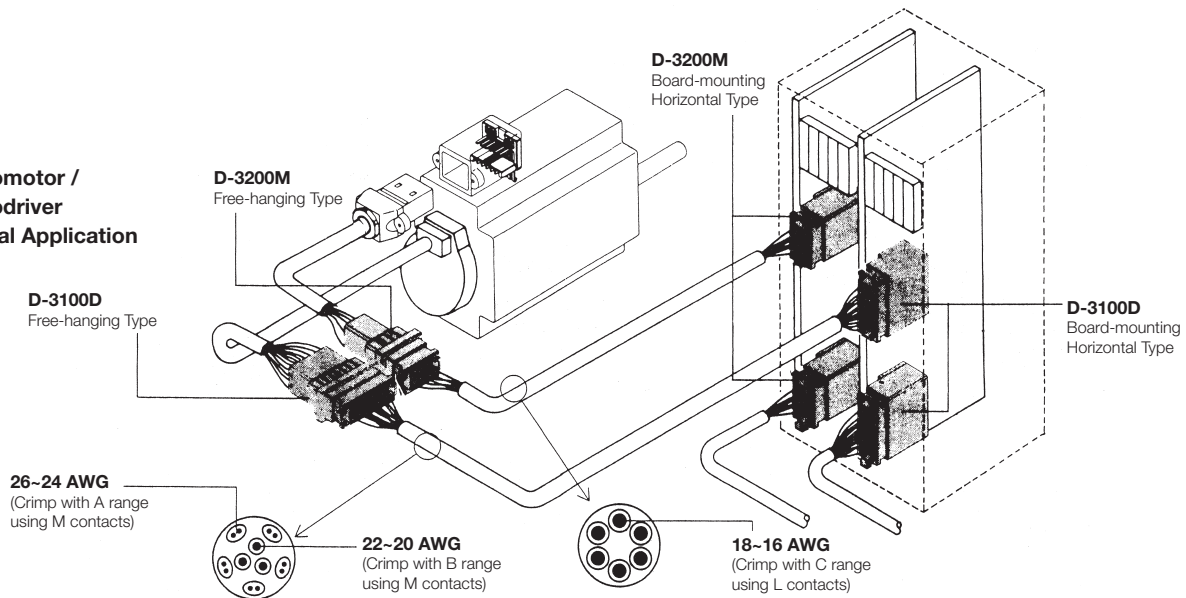

D-3000 Series (Continued)

Application Tooling (Continued)

AMP-3K/40 and AMP-5K/40 Terminating Machines



Mini-Applicator
Minimum Quantity : 1



Contact Technical Support for
Mini-Applicator Part Number

The AMP-3K/40 and AMP-5K/40 Terminators are designed for customers that require the increased output and quality of a semi-automatic machine at a competitive price. By incorporating the most commonly requested features as standard and offering a long list of optional equipment, these terminators offer flexibility to meet the specific needs of various applications at the lowest possible cost.

- 3,000 lb. [1361 kg] max. crimp force (AMP-3K/40)
- 5,000 lb. [2268 kg] max. crimp force (AMP-5K/40)
- Toolless removal of applicators and guards
- Jog capability
- Quiet, fast operation — 80/76 dBA and cycle time less than 0.400 seconds
- Accepts Heavy Duty Mini style applicators
- Wide range of optional equipment such as toolless precision crimp height adjust, batch counter, CQM capability and work light
- Order Catalog 1654856 for specifications and part numbers

D-3000 Series

AMP-O-LECTRIC Model G Terminating Machine

The Model "G" Terminator is the most advanced design in the long-standing series of AMP-O-LECTRIC machines for terminating wire using reeled terminals and contacts. It features a reliable direct motor drive system. Its modular construction enables it to be used either as a bench-top unit, or in combination with fully-automatic lead-making equipment. For operator convenience, access to and lighting in the target area has been improved and the Crimp Quality Monitor (CQM) has been moved to eye level for bench-top use. The Model "G" is also quieter, plus improved guarding meets applicable European and domestic safety requirements.

- Quieter
- Improved guarding and lighting
- Toolless changeover of applicators
- Precision manual- or auto-adjust for crimp height
- Total and batch counter
- Accepts all existing Tyco Electronics miniature applicators, with minor modifications
- Reduced maintenance requirements
- Request Catalog 65828 for specifications and part numbers



AMP-O-MATIC Side-Feed Stripper/Crimper Machine

This semiautomatic bench machine strips and terminates wire in a single operation. You simply position the wire against a spot illuminated on the wire stop and cycle the machine. In the automatic mode, the machine cycles when the wire touches the wire stop.

Using interchangeable applicators, this versatile machine is ideal for terminating jacketed cable with a variety of pin and socket contacts. Applicators are also available for non-AMP products.

- Strip and terminate wires 32-14 AWG [0.03-2mm²]
- Fast set-up times: 10 minutes or less
- Illuminated target area
- Convenient scrap removal
- Select foot switch or wire-sensor mode of operation
- Request Catalog 65004 for specifications and part numbers



D-3000 Series (Continued)

Application Tooling

(Continued)

Extraction Tool

This tool is used to extract contacts from wire-type tab/receptacle housings.



Part Number: 234168-1
(411-5726)

*Take care not to insert into the Contact Section.

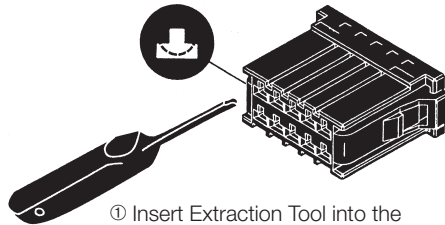

① Insert Extraction Tool into the narrow section of the upper convex cavity of housing in the direction as shown (Make sure the Tool's top and bottom are in correct position.)

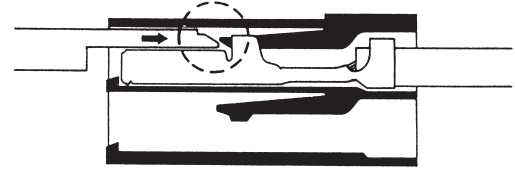

② The Extraction Tool tip lifts up housing lance, making contact free.

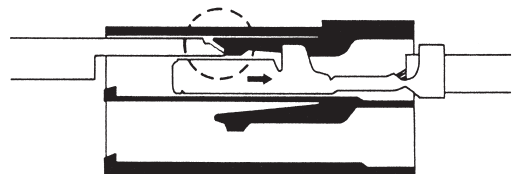

③ Contact can now be pulled out.

D-3000 Series

Keying Plug

(used to help prevent misinsertion)

Keying plug is used to minimize the possibility of contacts being inserted in wrong directions when using connectors of the same size end-to-end.

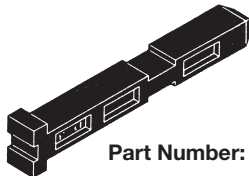

Part Number: 175855-1

Tab Contact Cutting Tool

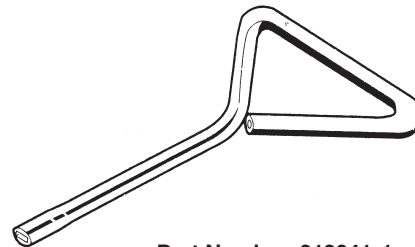

Part Number: 919041-1

How To Use Plug and Tool

*Some of the products in this Series (D-3100S/D-3100M/D-3200S/D-3200M) are preloaded with keying plugs to help prevent misinsertion.

① Insert a keying plug in one position of receptacle Housing.

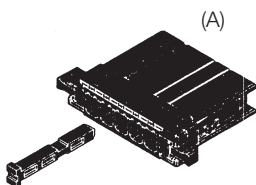

② Twist off a tab in the corresponding position of mating Tab Header and empty that position. To twist off the tab, insert Cutting Tool into its root and turn Tool as shown.

* For Tab housing (Panel/Free hanging Types), leave Housing empty by not inserting a contact in one position.

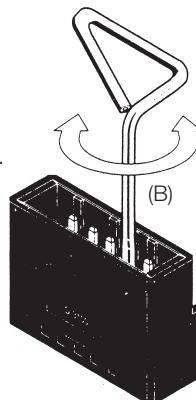

③ This being done, contacts cannot be inserted in wrong direction.

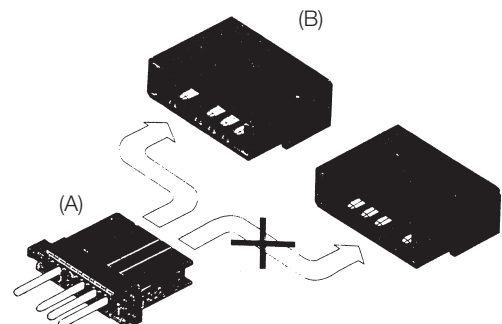

D-3000 Series (Continued)

Connector Mounting Hardware

L Fittings

Used to secure free-hanging type tab housings onto panels. Applicable housings are specified in the table of housings.

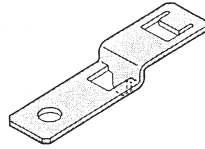

Part Number: 900121-2 (S)

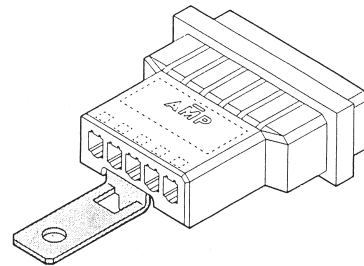

External Dimensions

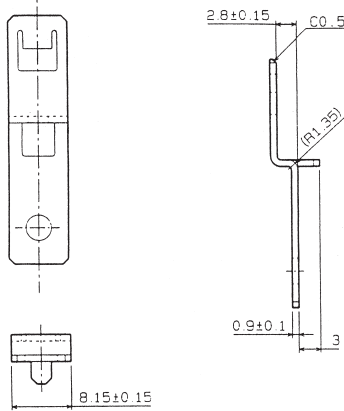

Part Number: 900121-2 (S)

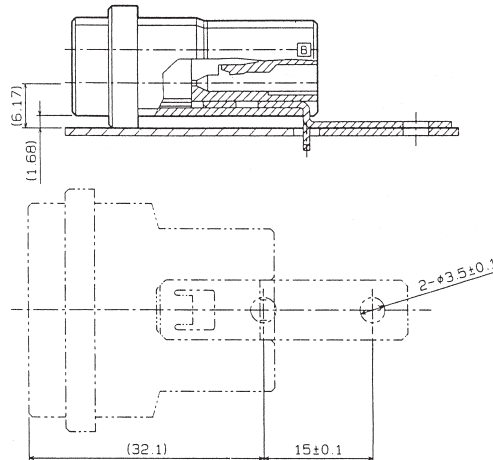

The location where housing is attached varies by Series and size. Check with sample.

Push Rivets

Used to secure panel-type tab housings onto panels (Use as handy mounting hardware. Cannot be used with larger sized housings or those that are frequently inserted and withdrawn).

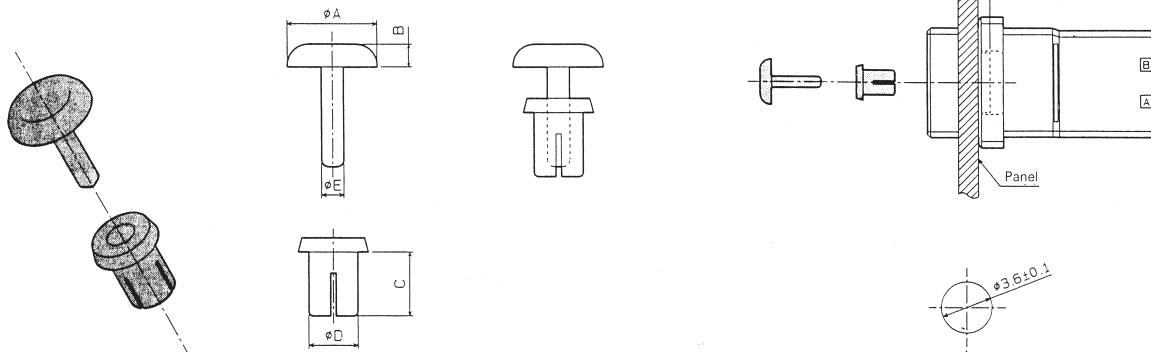

Recommended panel hole dimension

Part Number	Panel Thickness	Dimensions					Insertion Force	Retention Force
		A	B	C	D	E		
900128-1	0.3-1.3	6.4	1.6	4.5	3.5	1.95	2-3kg	13kg Min.*
900128-2	1.3-2.3	6.4	1.6	5.5	3.5	1.95	2-3kg	13kg Min.*

*When 2 push rivets are used.

D-3000 Series

D-3000 Series (Continued)

D-3100S — Standard 1-Row Type

Appearance Board mounting pitch: Horizontal Type 150 mils (3.81mm) / Vertical Type 150 mils (3.81mm)
 Dielectric Withstanding Voltage: 1,500V (for one minute)
 Voltage Rating: 250 V

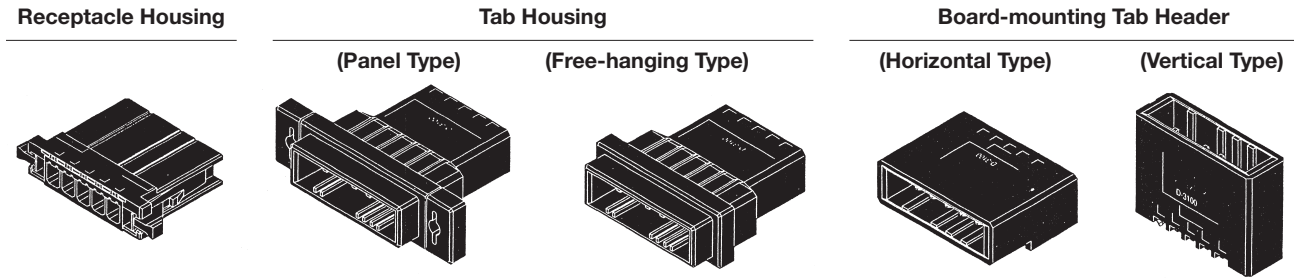
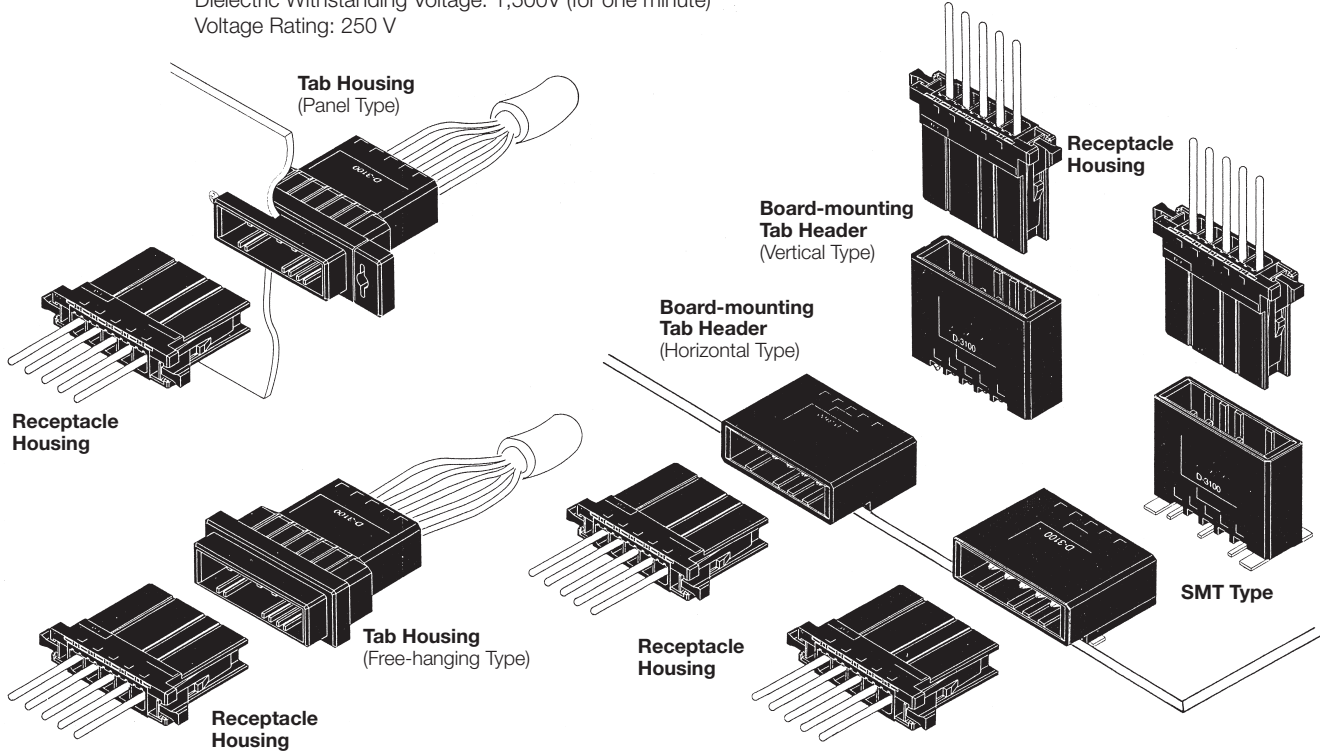

No. of Pos.	Keying	Receptacle Housing	Tab Housing			Board-mounting Tab Header	
			Panel Type	Free-hanging Type	L Fitting	Horizontal Type	Vertical Type
2	See D-3200S Series						
3	X	1-178288-3*1	1-178802-3	1-177648-3	S	1-178293-□	1-178313-□
	Y	2-178288-3*2	2-178802-3	2-177648-3	S	2-178293-□	2-178313-□
4	X	1-178288-4	—	—	S	1-178294-□	1-178314-□
	Y	2-178288-4	—	—	S	2-178294-□	2-178314-□
5	X	1-178288-5*3	1-178802-5	1-177648-5	—	1-178295-□	1-178315-□
6	X	1-178288-6	—	—	—	1-178296-□	1-178316-□
	Y	2-178288-6	—	—	—	2-178296-□	2-178316-□
8	X	1-178288-7*4	1-178802-7	1-177648-7	—	1-178297-□	1-178317-□
10	X	1-178288-8	1-178802-8	1-177648-8	—	1-178298-□	1-178318-□
	Y	2-178288-8	2-178802-8	2-177648-8	—	2-178298-□	2-178318-□

Note: Enter the following plating codes in -□ after Part Numbers:
 -2 = 0.38µm thick gold plating, -3 = 0.76µm thick gold plating,
 -5 = Tin plating

*1, *3 and *4 can be used as SMT Type Receptacle Housing.
 *1 and *2 can also be used in modular configuration in combination with D-3100M Tab Header.

D-3000 Series (Continued)

D-3100S — Standard 1-Row Type (Continued)

Keying

This product (D-3100S) is provided with keying plugs to help prevent misinsertion of contacts. Two types are available: X Type and Y Type (Shown below is the mating front of Tab Header).

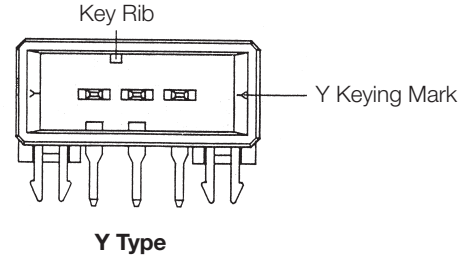
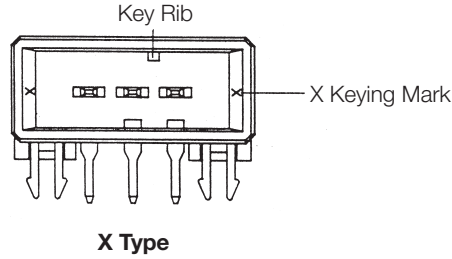

Applications

Typical Applications for Elevator

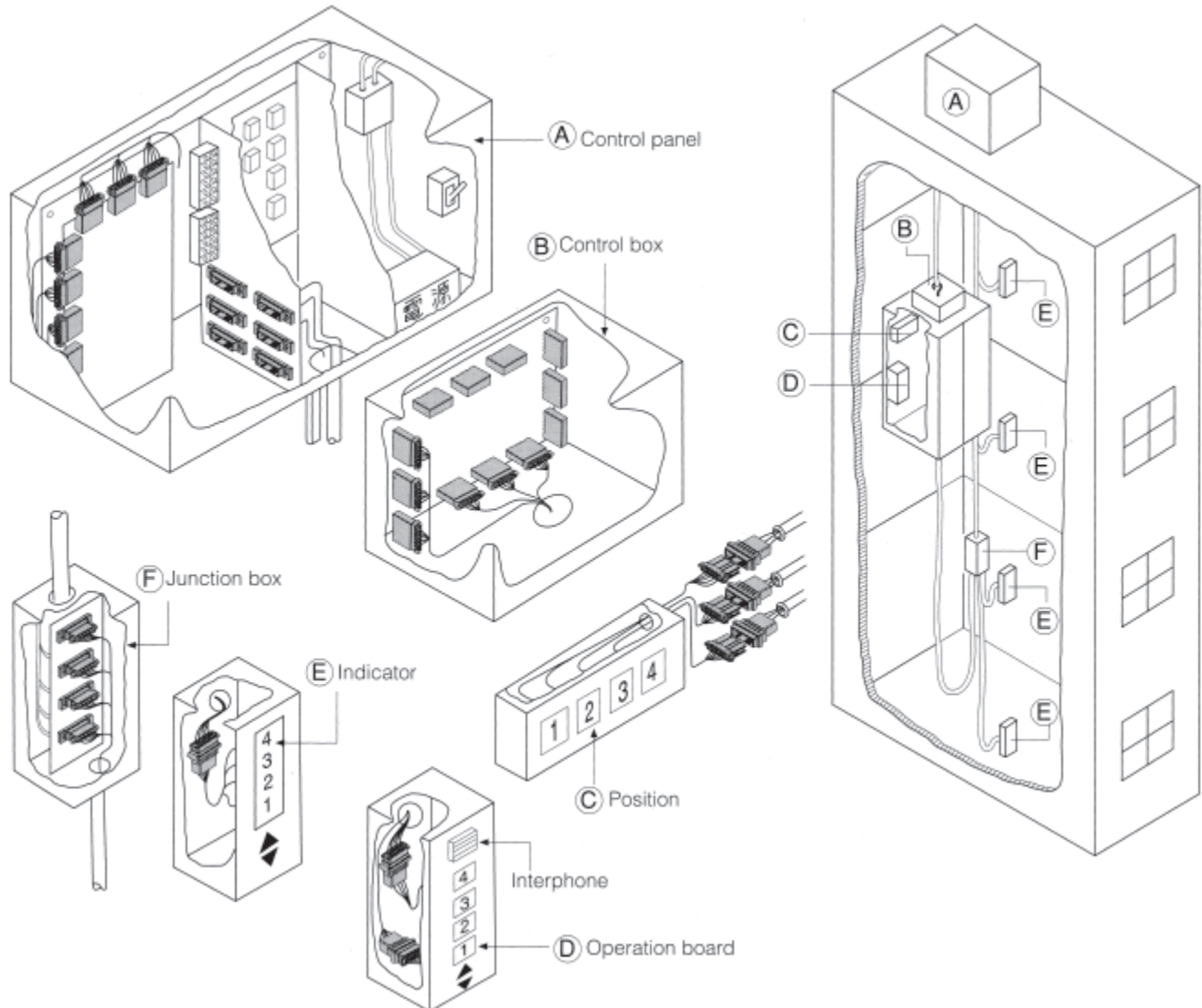

D-3000 Series

D-3000 Series (Continued)

D-3100S — Standard 1-Row Type (Continued)

Mating Dimensions

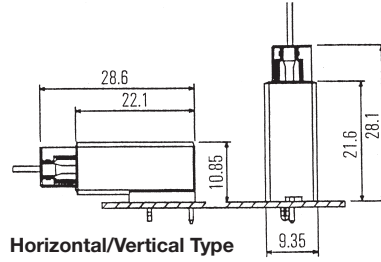
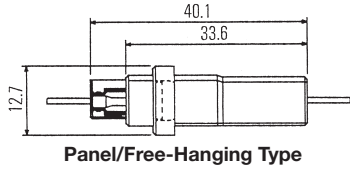

Receptacle Housing

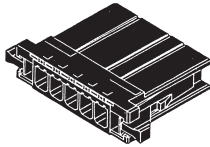

Mating Tab Connector

Part Number:
 □-178802-□ □-178313-□
 □-177648-□ thru
 □-178293-□ □-178318-□
 thru
 □-178298-□

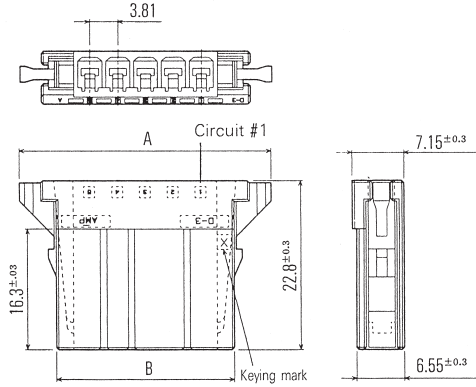

No. of Pos.	Part Number	Dimensions	
		A	B
2	—	—	—
3	□-178288-3	26.76	16.7
4	□-178288-4	30.57	20.51
5	□-178288-5	34.38	24.32
6	□-178288-6	38.19	28.13
8	□-178288-7	45.81	35.97
10	□-178288-8	53.43	43.37

Tab Housing

Mating Receptacle Housing

Part Number:
 □-178288-□

Panel Type

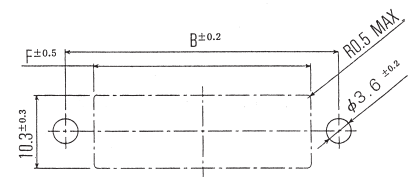
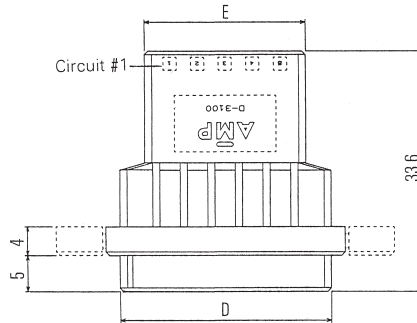
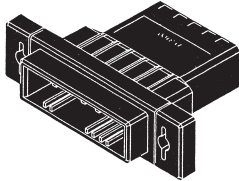

Panel Cutout

When mounting panel from the front, apply clamping torque of less than 49N [11 lbf].

Free-hanging Type

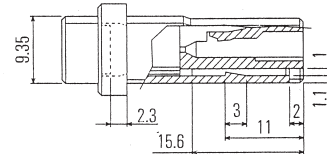
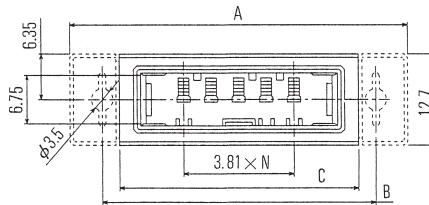
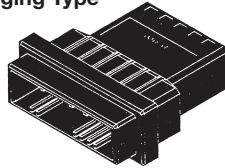

No. of Pos.	Part Number		Dimensions					
	Panel Type	Free-hanging Type	A	B	C*	D	E	F
2	—	—	—	—	—	—	—	—
3	□-178802-3	□-177648-3	40	31	25.57	21.62	14.62	22.6
4	—	—	—	—	—	—	—	—
5	□-178802-5	□-177648-5	47	38	33.19	29.24	22.24	30.2
6	—	—	—	—	—	—	—	—
8	□-178802-7	□-177648-7	59	50	44.62	40.67	33.67	41.6
10	□-178802-8	□-177648-8	67	58	52.24	48.29	41.29	49.2

*Applicable to Free-hanging Type only.

D-3000 Series (Continued)

D-3100S — Standard
1-Row Type (Continued)

Board-mounting Tab Header (Horizontal Type)

Mating Receptacle Housing
Part Number:
□-178288-□

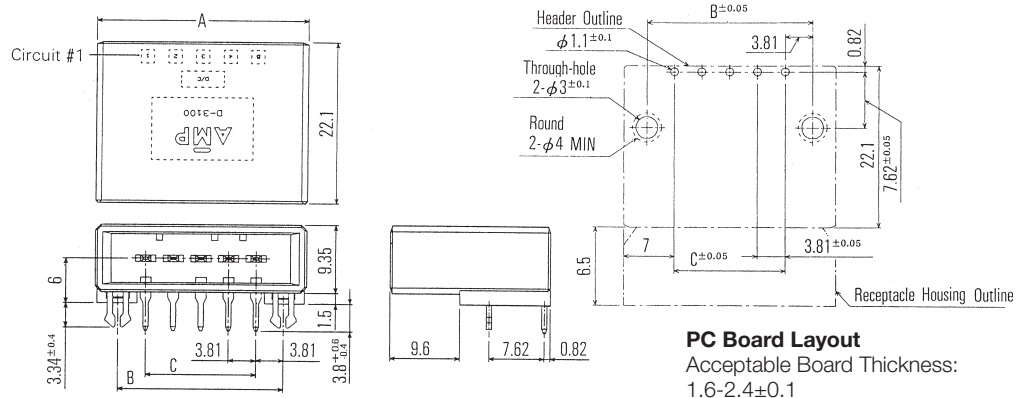
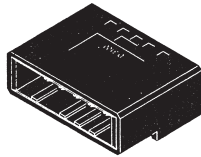

PC Board Layout
Acceptable Board Thickness:
1.6-2.4±0.1

No. of Pos.	Part Number	Dimensions		
		A	B	C
2	—	—	—	—
3	□-178293-□	21.62	15.24	7.62
4	□-178294-□	25.43	19.05	11.43
5	□-178295-□	29.24	22.86	15.24
6	□-178296-□	33.05	26.67	19.05
8	□-178297-□	40.67	34.29	26.67
10	□-178298-□	48.29	41.91	34.29

Tube Package Dimensions (Ref.)

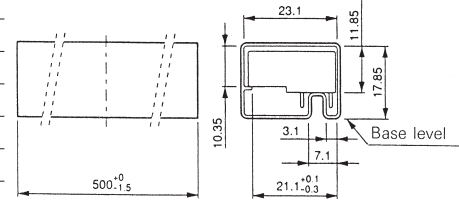

Board-mounting Tab Header (Vertical Type)

Mating Receptacle Housing
Part Number:
□-178288-□

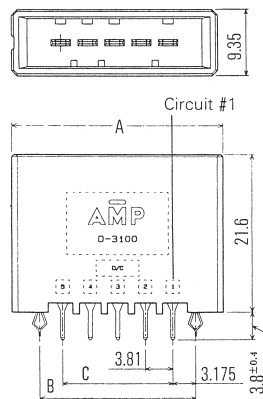
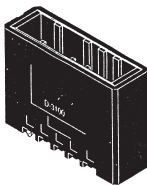

PC Board Layout
Acceptable Board Thickness:
1.6-2.4±0.1

No. of Pos.	Part Number	Dimensions		
		A	B	C
2	—	—	—	—
3	□-178313-□	21.62	13.97	7.62
4	□-178314-□	25.43	17.78	11.43
5	□-178315-□	29.24	21.59	15.24
6	□-178316-□	33.05	25.4	19.05
8	□-178317-□	40.67	33.02	26.67
10	□-178318-□	48.29	40.64	34.29

Tube Package Dimensions (Ref.)

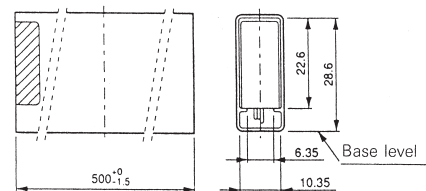

D-3000 Series (Continued)

D-3100S — Standard SMT Type

Appearance Dielectric Withstanding Voltage: 1,500 V (for one minute) Voltage Rating: 250 V

Receptacle Housing

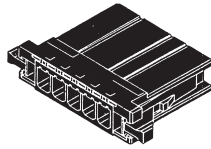

Board-mounting Tab Header

(Horizontal Type)

(Vertical Type)

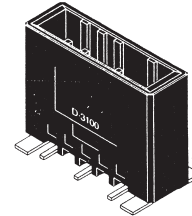
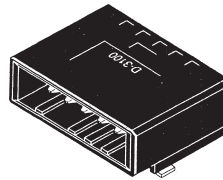

Part Number Chart

No. of Pos.	Keying	Receptacle Housing*	Board-mounting Tab Header	
			Horizontal Type	Vertical Type
3	x	1-178288-3	—	—
5	x	1-178288-5	1-177662-□	1-177665-□
8	x	1-178288-7	1-179188-□	—

Note: Enter the following plating codes in -□ after Part Numbers:
 -2 = 0.38µm thick gold plating
 -3 = 0.76µm thick gold plating

Material of Tab Header : P.P.S.
 *D-3100S Series.

Mating Dimensions

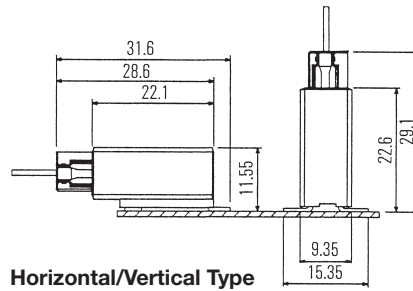

Receptacle Housing

Mating Tab Header

Part Number:

- 177662-□
- 177988-□
- 177665-□

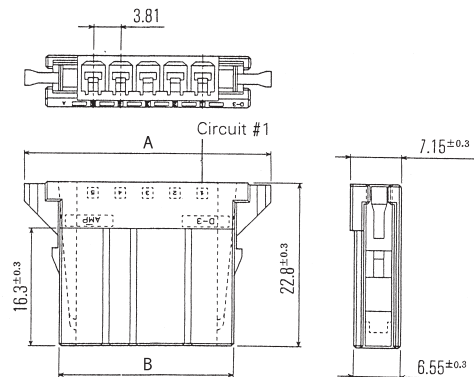
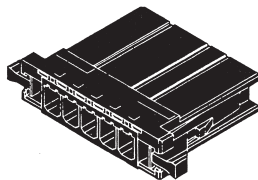

No. of Pos.	Part Number	Dimensions	
		A	B
3	□-178288-3	26.76	16.7
5	□-178288-5	34.38	24.32
8	□-178288-7	45.81	35.97

D-3000 Series (Continued)

D-3100S — Standard SMT Type (Continued)

Board-mounting Tab Header (Horizontal Type)

Mating Receptacle Housing
Part Number:
□-178288-□

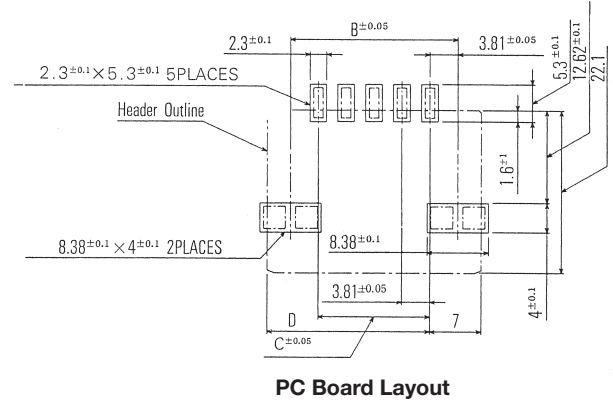
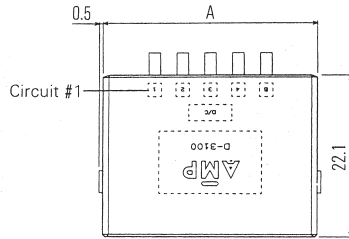
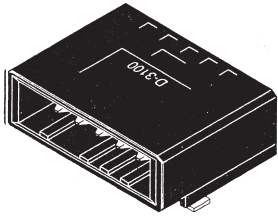

PC Board Layout

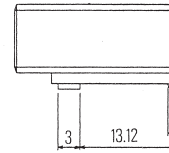
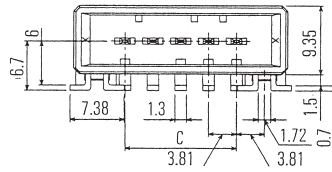

Tube Package Dimensions (Ref.)

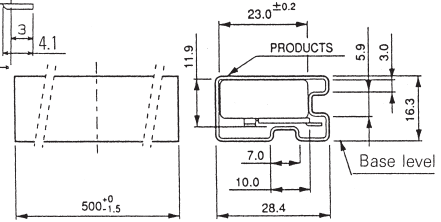

No. of Pos.	Part Number	Dimensions			
		A	B	C	D
3	—	—	—	—	—
5	□-177662-□	29.24	22.86	15.24	22.24
8	□-179188-□	40.67	34.29	26.67	33.67

Board-mounting Tab Header (Vertical Type)

Mating Receptacle Housing
Part Number:
□-178288-□

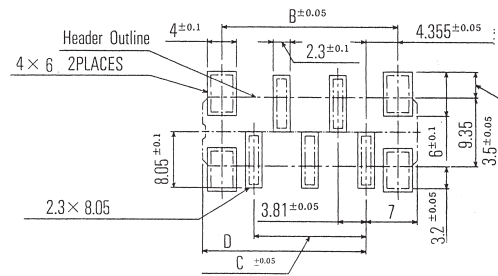
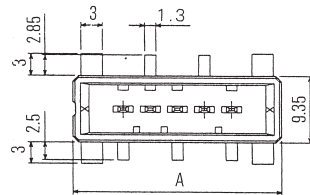
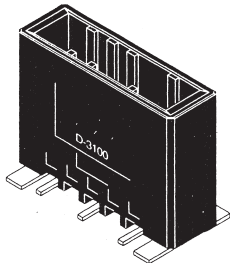

PC Board Layout

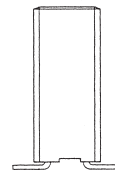
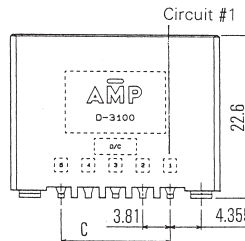

Tube Package Dimensions (Ref.)

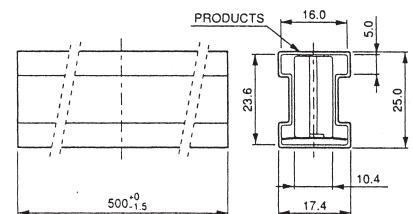

No. of Pos.	Part Number	Dimensions			
		A	B	C	D
3	—	—	—	—	—
5	□-177665-□	29.24	23.95	15.24	22.24
8	—	—	—	—	—

D-3000 Series

D-3000 Series (Continued)

D-3100D — Standard 2-Row Type

Appearance Board mounting pitch: Horizontal Type 150x150mils (3.81x3.81mm) / Vertical Type 150x200mils (3.81x5.08mm)
 Dielectric Withstanding Voltage: 1,500V (for one minute)
 Voltage Rating: 250 V

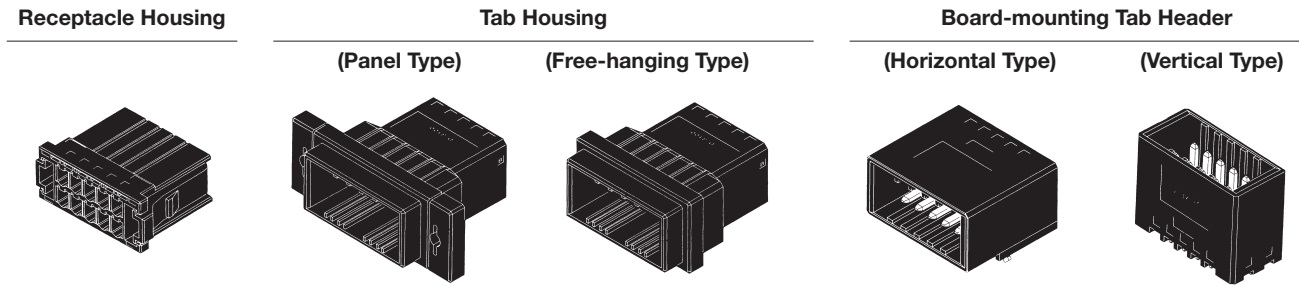
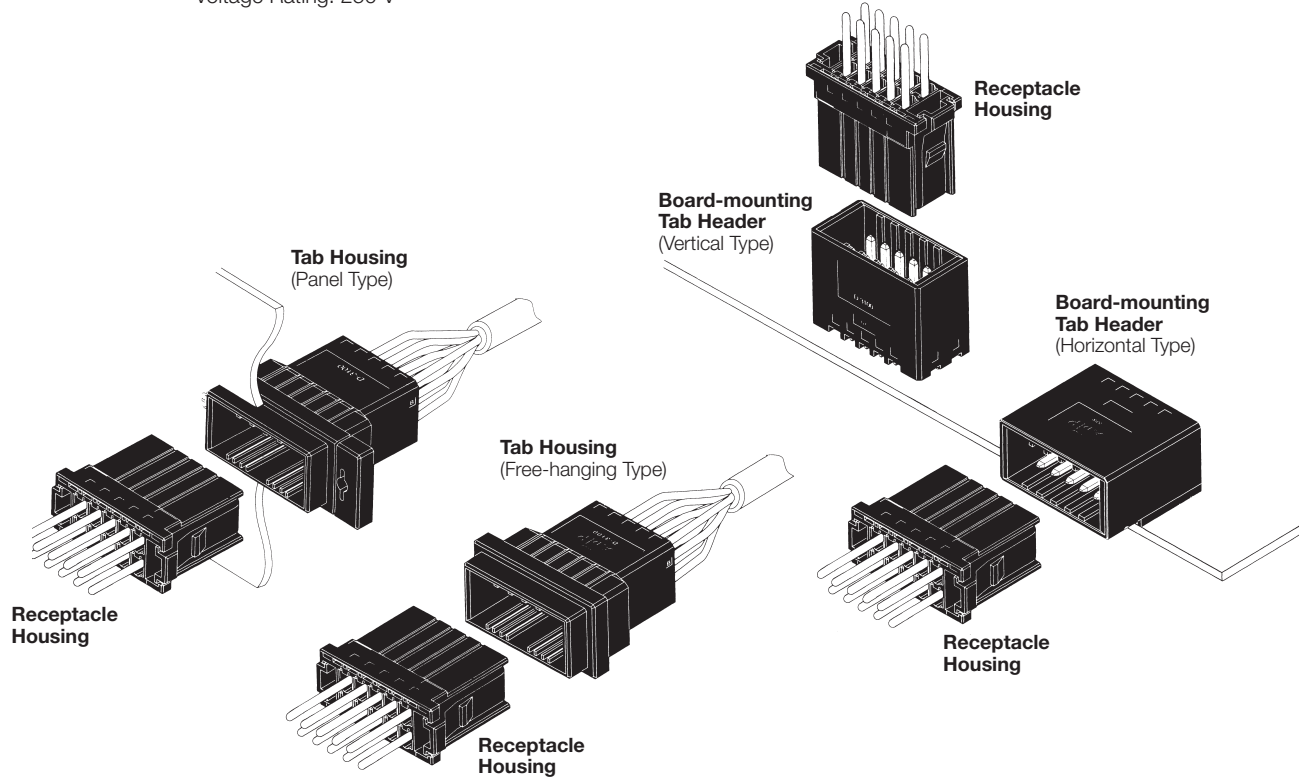

Part Number Chart

No. of Pos.	Receptacle Housing	Tab Housing			Board-mounting Tab Header	
		Panel Type	Free-hanging Type	L Fitting	Horizontal Type	Vertical Type
4	—	—	—	—	—	—
6	178289-3	178803-3	178964-3	S	178303-□	178323-□
8	178289-4	—	—	—	1717412-□	—
10	178289-5	178803-5	178964-5	—	178305-□	178325-□
12	178289-6	178803-6	178964-6	—	178306-□	178326-□
16	178289-7	178803-7	178964-7	—	178307-□	178327-□
20	178289-8	178803-8	178964-8	—	178308-□	178328-□

Note: Enter the following plating codes in -□ after Part Numbers:
 -2 = 0.38µm thick gold plating, -3 = 0.76µm thick gold plating,
 -5 = Tin plating

D-3000 Series (Continued)

D-3100D — Standard 2-Row Type (Continued)

Mating Dimensions

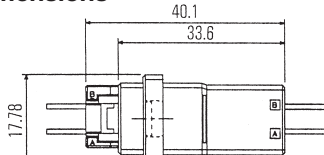

Panel/Free-Hanging Type

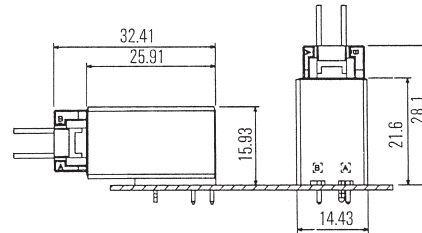

Horizontal/Vertical Type

Receptacle Housing

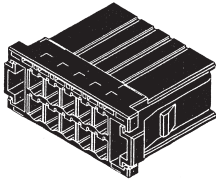

Mating Tab Connector

Part Number:

- 178803-□ 1717412-□
- 178964-□ 178323-□
- 178303-□ thru 178328-□
- 178308-□

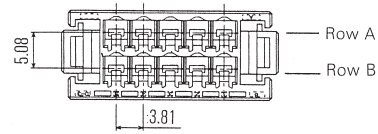

No. of Pos.	Receptacle Housing	Dimensions	
		A	B
6	178289-3	24.36	16.70
8	178289-4	28.17	20.51
10	178289-5	31.98	24.32
12	178289-6	35.09	28.35
16	178289-7	42.71	35.97
20	178289-8	51.03	43.37

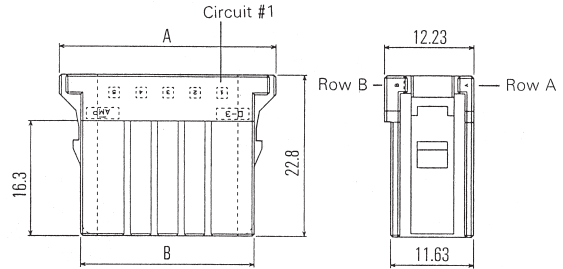

Tab Housing

Mating Receptacle Housing

Part Number:

178289-□

Panel Type

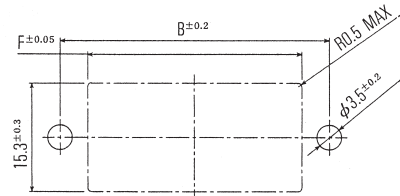
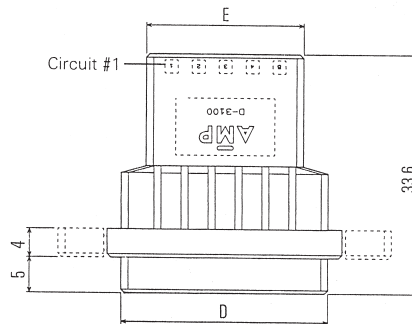
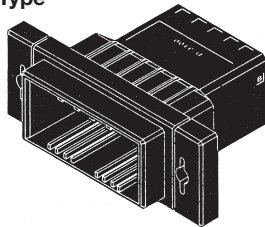

Panel Cutout

When mounting panel from the front, apply clamping torque of less than 49N [11 lbf].

Free-hanging Type

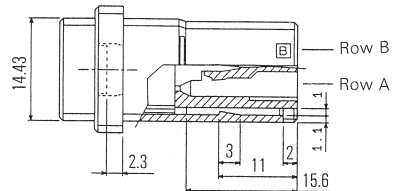
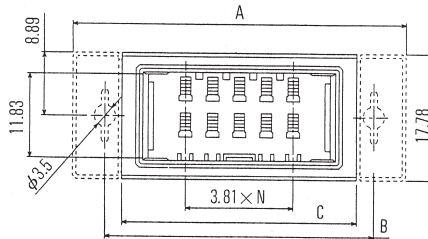
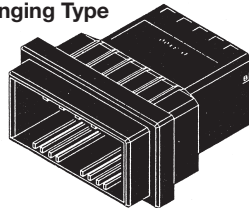

No. of Pos.	Part Number		Dimensions					
	Panel Type	Free-hanging Type	A	B	C	D	E	F
4	—	—	—	—	—	—	—	—
6	178803-3	178964-3	40	31	25.57	21.62	14.62	22.6
10	178803-5	178964-5	47	38	33.19	29.24	22.24	30.2
12	178803-6	178964-6	51	42	37.00	33.05	26.05	34.0
16	178803-7	178964-7	59	50	44.62	40.67	33.67	41.6
20	178803-8	178964-8	67	58	52.62	48.29	41.29	49.2

D-3000 Series (Continued)

D-3100D — Standard 2-Row Type (Continued)

Board-mounting Tab Header (Horizontal Type)

Mating Receptacle Housing
Part Number:
178289-□

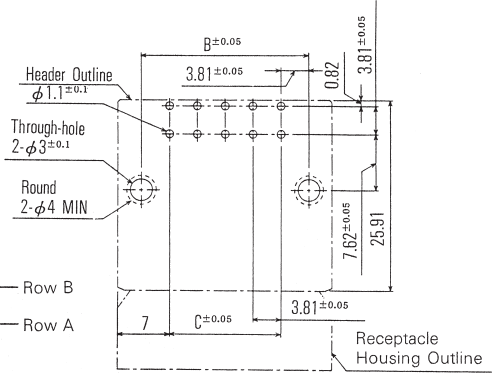
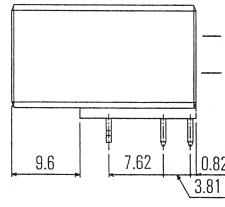
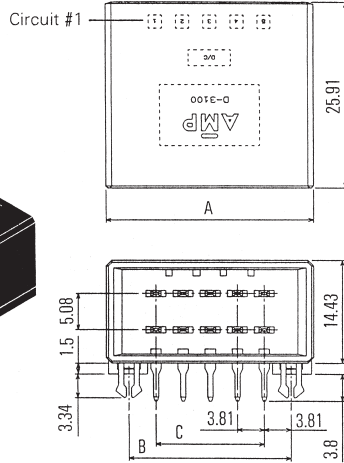
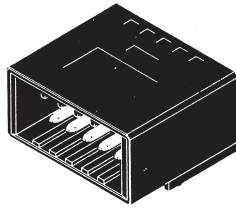

PC Board Layout
Acceptable Board Thickness:
1.6-2.4±0.1

Solder tine section is 0.64 sq.

No. of Pos.	Part Number	Dimensions		
		A	B	C
6	178303-□	21.62	15.24	7.62
8	1717412-□	25.43	19.05	11.43
10	178305-□	29.24	22.86	15.24
12	178306-□	33.05	26.67	19.05
16	178307-□	40.67	34.29	26.67
20	178308-□	48.29	41.91	34.29

Tube Package Dimensions (Ref.)

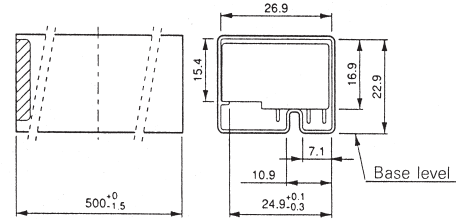

Board-mounting Tab Header (Vertical Type)

Mating Receptacle Housing
Part Number:
178289-□

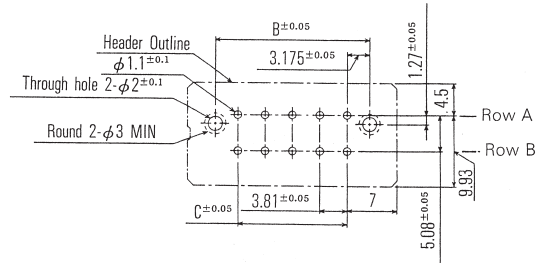
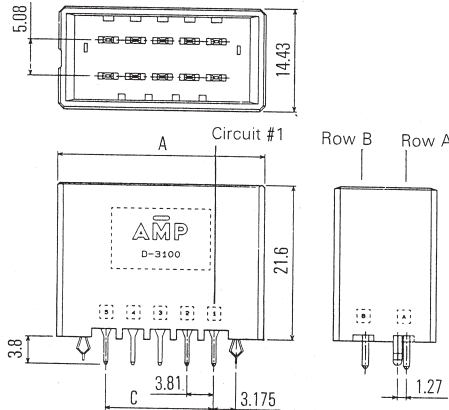
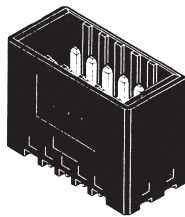

PC Board Layout
Acceptable Board Thickness:
1.6-2.4±0.1

No. of Pos.	Part Number	Dimensions		
		A	B	C
6	178323-□	21.62	13.97	7.62
10	178325-□	29.24	21.59	15.24
12	178326-□	33.05	25.4	19.05
16	178327-□	40.67	33.02	26.67
20	178328-□	48.29	40.64	34.29

Tube Package Dimensions (Ref.)

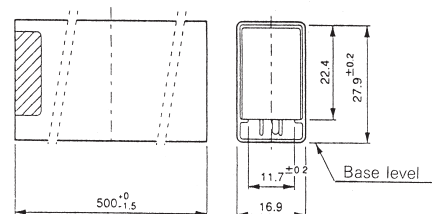

D-3000 Series (Continued)

D-3100M — Modular Type

Appearance

Connectors can be used in modular configurations in combination with D-3100S. Ideally Suited For Allocation of Signal Circuits
 Board mounting pitch: Horizontal Type 150x150mils (3.81x3.81mm) / Vertical Type 150x300mils (3.81x7.62mm)
 Dielectric Withstanding Voltage: 1,500V (for one minute)
 Voltage Rating: 250 V

D-3000 Series

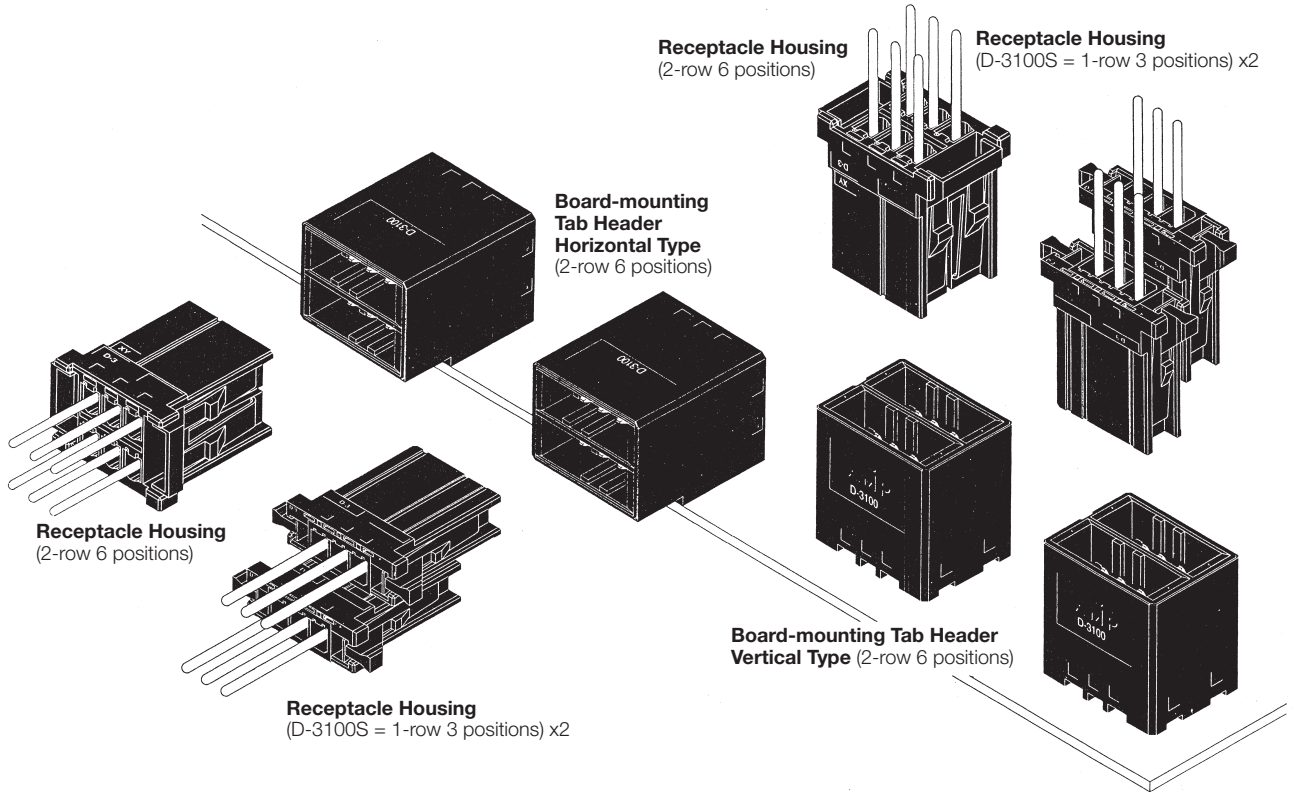

Receptacle Housing

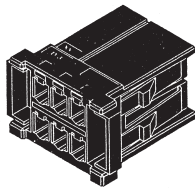

Board-mounting Tab Header

(Horizontal Type)

(Vertical Type)

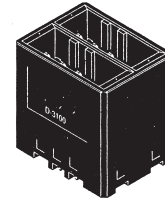
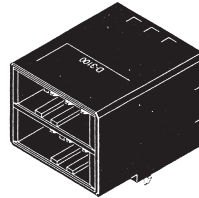

Part Number Chart

No. of Pos.	Keying	Receptacle Housing	Board-mounting Tab Header	
			Horizontal Type	Vertical Type
6	XX	1-178127-6	1-178137-□	1-178141-□
	YY	2-178127-6	2-178137-□	—
	XY	3-178127-6	3-178137-□	3-178141-□

Note: Enter the following plating codes in -□ after Part Numbers:
 -2 = 0.38µm thick gold plating
 -3 = 0.76µm thick gold plating
 -5 = Tin plating

D-3000 Series (Continued)

D-3100M — Modular Type

(Continued)

Keying

This product (D-3100M) is provided with keying to help prevent mismatching of connector halves. Keying is available in three types – XX Type, YY Type and XY Type. (Shown below is the mating surface of Tab Header.)

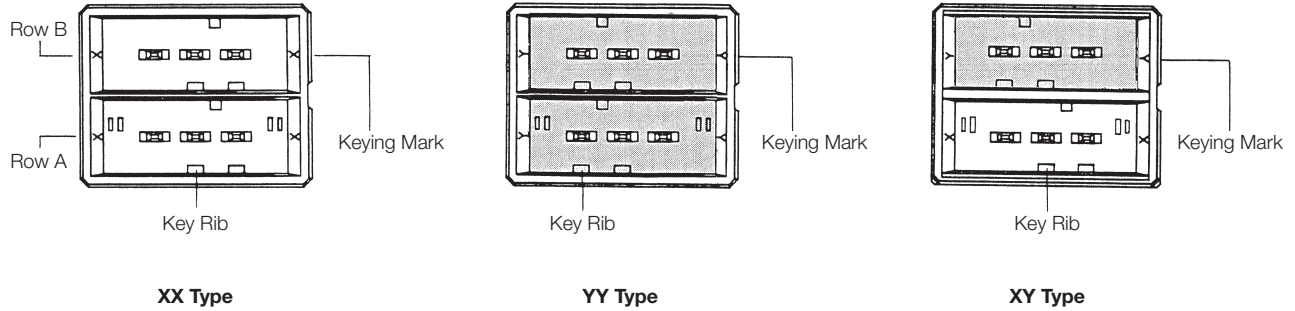

D-3000 Series

Table of Mating Combinations

Receptacle Housing		Board-mounting Tab Header				
		Horizontal Type		Vertical Type		
1 Row 3 positions (D-3100S) *	X Type P/N : 1-178288-3		1 Row 3 positions (D-3100S) *	X Type P/N : 1-178293-□	1 Row 3 positions (D-3100S) *	X Type P/N : 1-178313-□
	Y Type P/N : 2-178288-3		Y Type P/N : 2-178293-□	Y Type P/N : 2-178313-□		
2 Rows 6 positions 	XX Type P/N : 1-178127-6		2 Rows 6 positions 	XX Type P/N : 1-178137-□	2 Rows 6 positions 	XX Type P/N : 1-178141-□
	XX Type P/N : 2-178127-6		YY Type P/N : 2-178137-□	YY Type P/N : 2-178141-□		
	XY Type P/N : 3-178127-6		XY Type P/N : 3-178137-□	XY Type P/N : 3-178141-□		

The housing with asterisk (*) same as D-3100S Series.

D-3000 Series (Continued)

D-3100M — Modular Type

(Continued)

Mating Dimensions

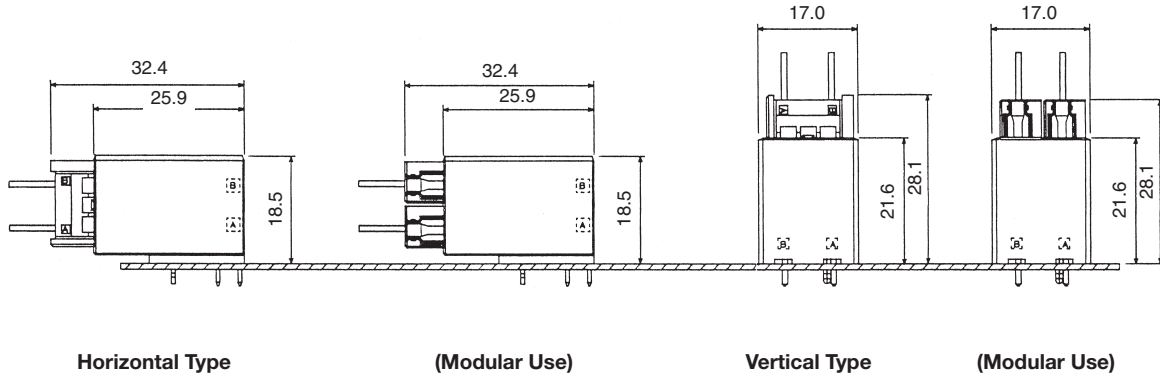

D-3000 Series

Receptacle Housing

Mating Tab Header

Part Number:

□-178137-□

□-178141-□

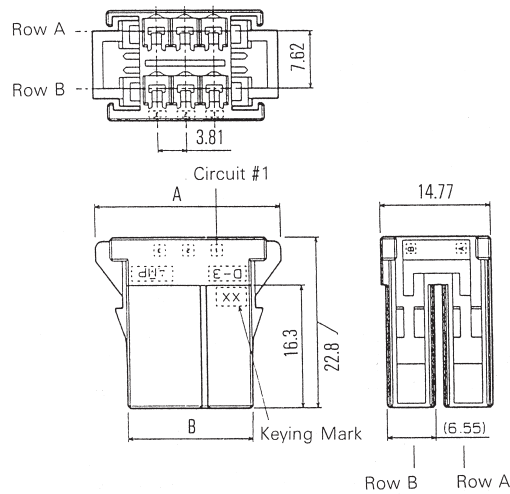
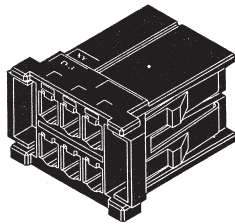

No. of Pos.	Part Number	Dimensions	
		A	B
6	□-178127-6	24.76	16.7

Notice:

*Although external or mounting dimensions are described in the catalog, the specifications are subject to change. When selecting products for your requirements, please request the appropriate drawings. Product Specifications, Instruction Sheets, etc., are also available. It is recommended that you request these documents as well.

D-3000 Series (Continued)

D-3100M — Modular Type

(Continued)

Board-mounting Tab Header (Horizontal Type)

Mating Receptacle Housing
Part Number:

□-178127-□

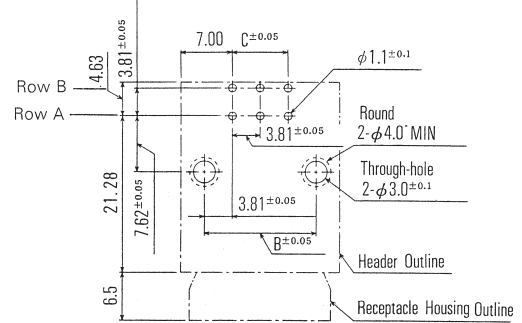
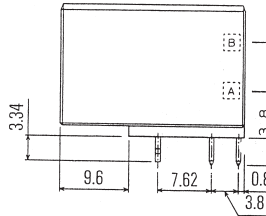
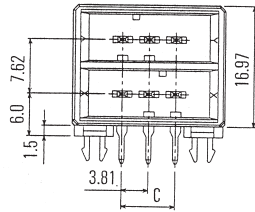
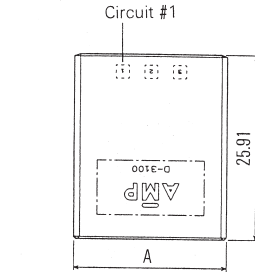
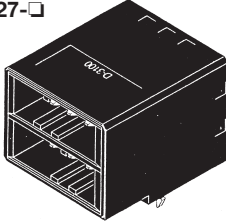

PC Board Layout

Acceptable Board Thickness:
1.6-2.4±0.1

Tube Package Dimensions (Ref.)

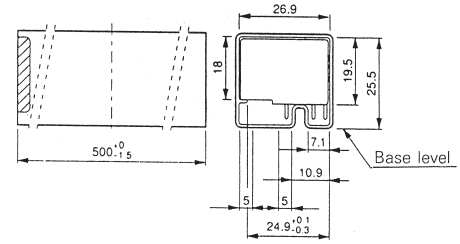

No. of Pos.	Part Number	Dimensions		
		A	B	C
6	□-178137-□	21.62	15.24	7.62

Board-mounting Tab Header (Vertical Type)

Mating Receptacle Housing
Part Number:

□-178127-□

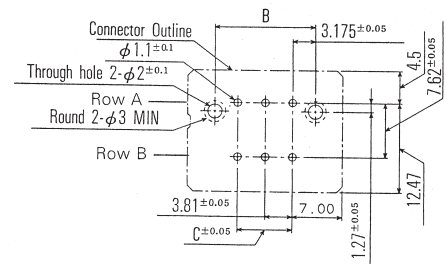
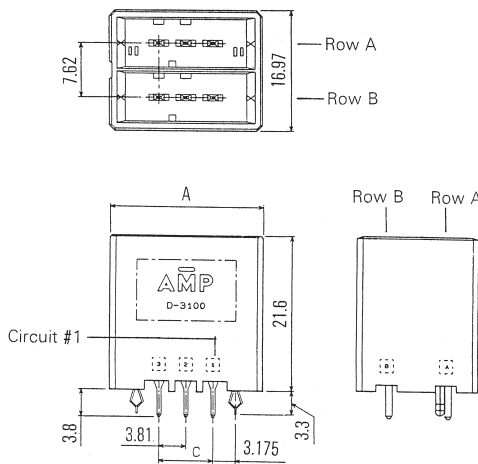
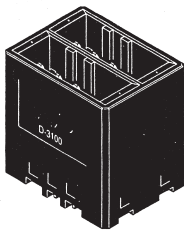

PC Board Layout

Acceptable Board Thickness:
1.6-2.4±0.1

Tube Package Dimensions (Ref.)

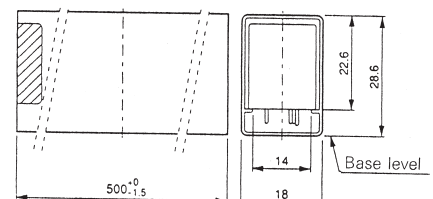

No. of Pos.	Part Number	Dimensions		
		A	B	C
6	□-178141-□	21.62	13.97	7.62