

Glass-Epoxy Receptacles with .88 [22.35] Barrel Depth

Flanged, for Hermetic Seal
Part Number 861254-1

Weight — 5 grams

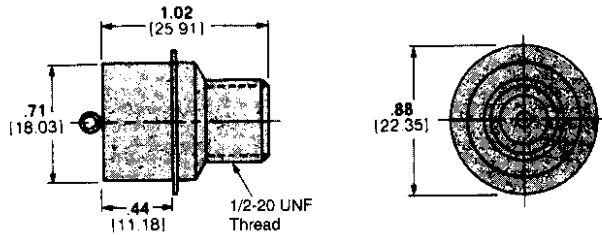

These receptacles are for use with RFI Shielded Lead Assemblies shown on the preceding page.

Molded Receptacle Part Number 850306-3

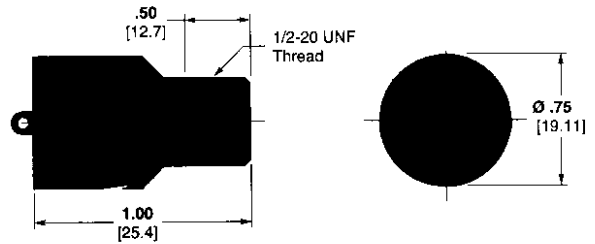

For Encapsulated Units Part Number 834333-2

Weight — 4 grams

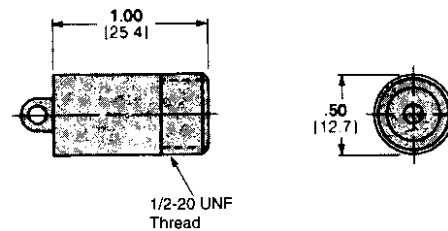

Bulkhead Receptacle Part Number 449690-1

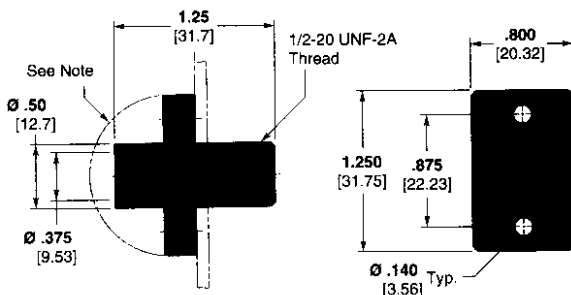

Note: Customer must protect back end against arc-over and breakdown if bulkhead and mounting hardware are metallic and at ground potential.

Special Receptacle Part Number 448463-1

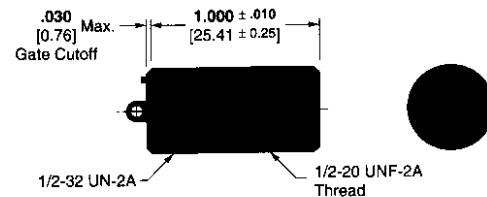

Flanged, Bolt Mount Part Number 858827-1

Weight — 16 grams

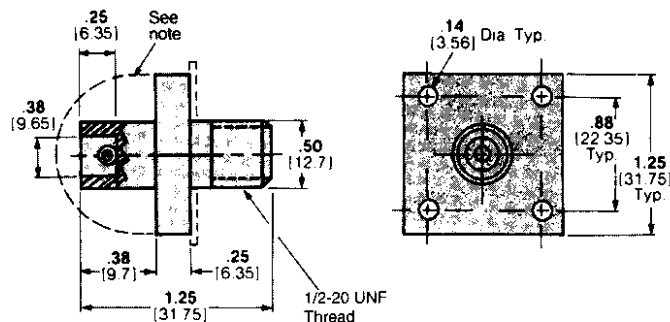

Note: If the panel or mounting hardware is at ground potential, guard against arc-over and breakdown within the area defined by this line.

With Recessed Terminal for Encapsulated Units Part Number 849610-3

Weight — 5 grams

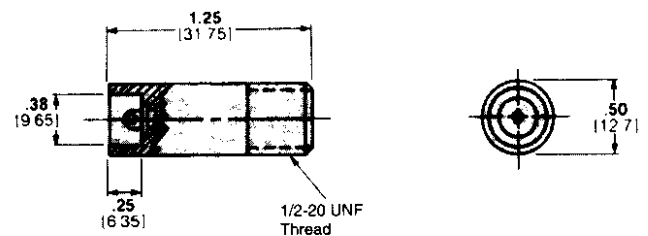

Receptacles are available with gold plated contacts.