

1.0mm Pitch

Series 5015

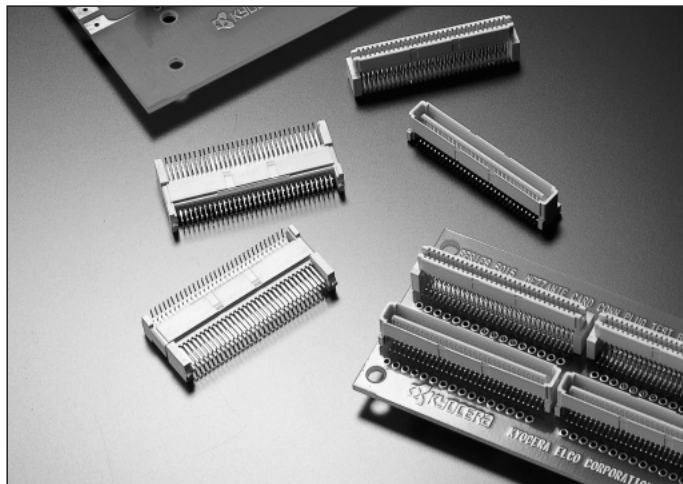

シリーズ (Series)	5015
基板間高さ (Stacking Height)	8.0mm, 9.0mm, 10.0mm, 11.0mm, 12.0mm, 13.0mm, 14.0mm, 15.0mm
極間隔 (Pitch)	1.0mm
極数 (No. of Positions)	64
定格電流 (Rated Current)	AC/DC 1.0A(5Contacts)
定格電圧 (Rated Voltage)	AC/DC 250V
耐電圧 (D.W.Voltage)	AC 250Vrms/min.
コンタクト材質 (Contact Material)	銅合金 Copper alloy
インシュレータ材質 (Insulator Material)	耐熱樹脂 Heat resistance plastic
使用温度範囲 (Operating Temperature)	-40~85°C

SERIES 5015

◇概要

5015シリーズは、産業用コンピュータ、産業用機械に搭載される、VMEバス、ホスト基板のアプリケーションの規格である、IEEE P-1386 Common Mezzanine Card Standardをサポートするコネクタです。

1.0mmピッチ、64極、SMT。基板間高さは、プラグとリセプタクルとの組み合わせにより8.0mm~15.0mmに対応します。

VMEバスシステムに機能性を付加したモジュラーボード(=メザニンカード)は、IEEE P-1386スタンダード規格の発展によりこれまでより手軽に使用できるようになりました。

PCIスタンダード規格に準拠するチップ、構成要素、ソフトウェアを取り巻く環境は、既にパーソナルコンピュータの市場まで広がっています。

◇Outline

Series 5015 is Board to Board connector system which support the IEEE P-1386 standard for mezzanine card installation in industrial computer applications including VME bus, Future bus, Compact-PCI bus and other host systems.

This is 1.0mm pitch, 64position, SMT connector capable mezzanine card as 8 to 15mm stacking height.

The IEEE P-1386 standard was developed to facilitate the use of modular boards (called mezzanine cards) to add functionality to VME bus systems, typically used in real time systems and industrial computers.

PCI was selected as the new auxiliary bus structure because of its higher bandwidth, speed, and flexibility for handling I/O functions. In addition, the chips, components, and software for implementing the PCI standard were already in wide use by the personal computer marketplace.

Parallel Stacking Height Matrix (mm)

		Receptacle Variation		
		STD	H3	H5
Plug Variation	STD	8.0	11.0	13.0
	H1	9.0	12.0	14.0
	H2	10.0	13.0	15.0

本カタログには推奨めっきを掲載しております。めっき種類・仕様、ならびに生産対応可能極数については営業部に御確認願います。

Recommended plating types are mentioned in this catalogue. For other plating types and their specifications, and available numbers of positions, please feel free to contact our sales department.

1.0mm Pitch
SERIES

5015

メザニンカードコネクタ プラグ

Plug (IEEE P-1386 Common Mezzanine Card Connector)

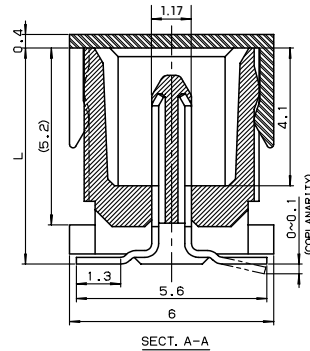
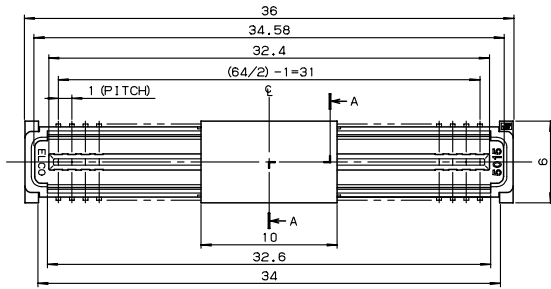

VARIATION	L
STD	6.25
H1	7.25
H2	8.25

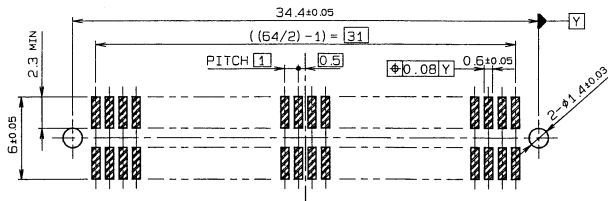
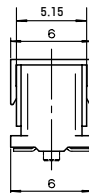
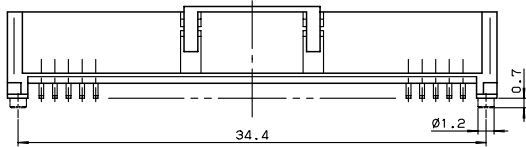

RECOMMENDED PATTERN

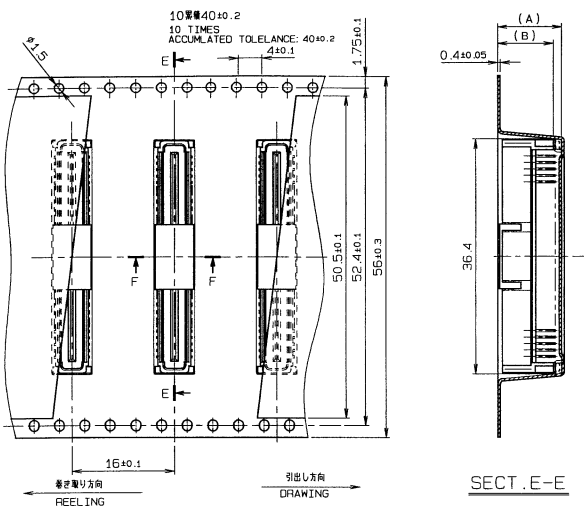

SECT. E-E

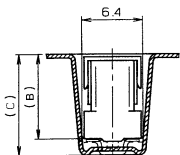

SECT. F-F

TYPE	A	B	C
STD	8.05	6.75	8.45
H1	9.05	7.75	9.45
H2	10.05	8.75	10.45

注文コード ORDERING CODE
14 5015 064 X XX XXXX

FINISH

- 863+ : Ni下地 1.2~4.0μm 接触部 Au0.76μm
(Ni Under Coated 1.2~4.0μm, Au0.76μm(Contact))
RoHS対応品 (RoHS Compliant Product)
- 861+ : Ni下地 1.2~4.0μm 接触部 Au0.25μm
(Ni Under Coated 1.2~4.0μm, Au0.25μm(Contact))
RoHS対応品 (RoHS Compliant Product)
- 863 : Ni下地 1.2~4.0μm 接触部 Au0.76μm
(Ni Under Coated 1.2~4.0μm, Au0.76μm(Contact))
RoHS非対応品 (RoHS not Compliant Product)
- 861 : Ni下地 1.2~4.0μm 接触部 Au0.25μm
(Ni Under Coated 1.2~4.0μm, Au0.25μm(Contact))
RoHS非対応品 (RoHS not Compliant Product)

TYPE

- 00 : STD
- 01 : H1
- 02 : H2

VARIATION

- 0 : ボス無 (Without Boss)
- 1 : ボス付 (With Boss)

注) 生産可能極数については営業部にご確認願います。
Note) Feel free to contact our sales department for available numbers of positions.

梱包数量 : 250個/リール
PACKING QUANTITY : 250/Reel

1.0mm Pitch

SERIES

5015

メザニンカードコネクタ リセ

Receptacle (IEEE P-1386 Common Mezzanine Card Connector)

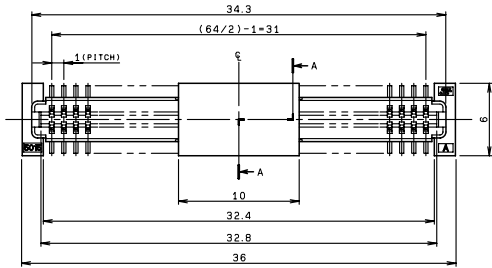

VARIATION	L
STD	5.60
H3	8.60
H5	10.60

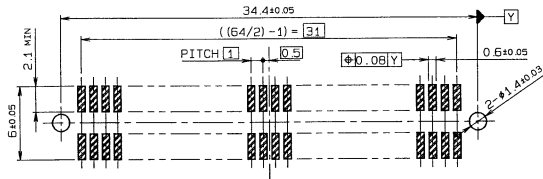
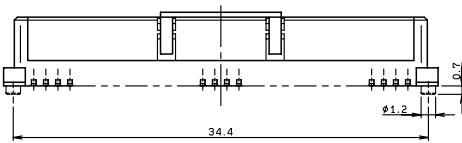
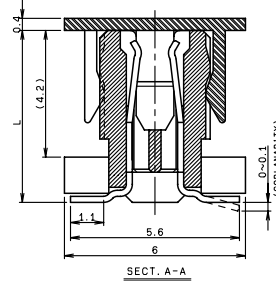

RECOMMENDED PATTERN

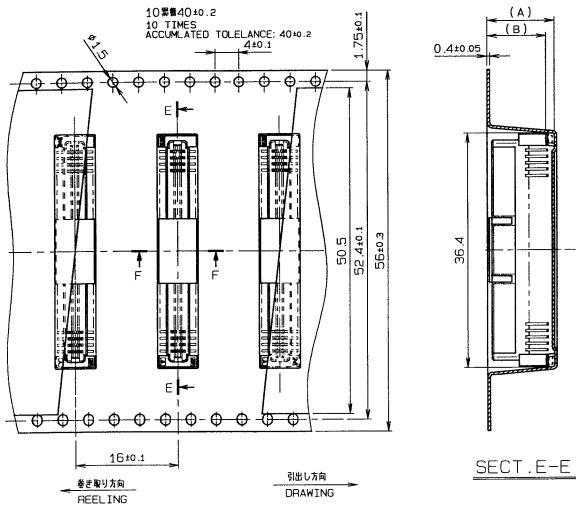

SECT. E-E

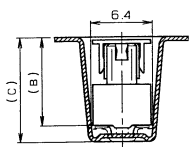

SECT. F-F

TYPE	A	B	C
STD	7.4	6.1	7.8
H3	10.4	9.1	10.8
H5	12.4	11.1	12.8

注文コード ORDERING CODE

24 5015 064 X XX XXXX

FINISH

- 863+ : Ni下地1.2~4.0μm 接触部Au0.76μm
(Ni Under Coated 1.2~4.0μm, Au0.76μm(Contact))
RoHS対応品 (RoHS Compliant Product)
- 861+ : Ni下地1.2~4.0μm 接触部Au0.25μm
(Ni Under Coated 1.2~4.0μm, Au0.25μm(Contact))
RoHS対応品 (RoHS Compliant Product)
- 863 : Ni下地1.2~4.0μm 接触部Au0.76μm
(Ni Under Coated 1.2~4.0μm, Au0.76μm(Contact))
RoHS非対応品 (RoHS not Compliant Product)
- 861 : Ni下地1.2~4.0μm 接触部Au0.25μm
(Ni Under Coated 1.2~4.0μm, Au0.25μm(Contact))
RoHS非対応品 (RoHS not Compliant Product)

TYPE

- 00 : STD
- 03 : H3
- 05 : H5

VARIATION

- 0 : ボス無 (Without Boss)
- 1 : ボス付 (With Boss)

注) 生産可能極数については営業部にご確認願います。
Note) Feel free to contact our sales department for available numbers of positions.

梱包数量 : 250個/リール
PACKING QUANTITY : 250/Reel