

Locking Clip Contacts and Housings

Product Facts

- Self-retaining contacts provide permanent connection with quick connect and disconnect
- Fast, easy installation with no additional locking hardware required
- Mates with .025 [0.64] square posts in a variety of configurations
- Single- and double-row configurations in up to 20 positions on .100 [2.54] centers
- Modular design permits end-to-end stacking (double- row only) for circuit grouping
- Choice of tin or select gold plating
- Housings made of 94V-0 rated glass-filled polyester
- Recognized under the Component Program of Underwriters Laboratories Inc., File No. E28476
- Certified by Canadian Standards Association, File No. LR 7189



Performance Characteristics

Contact Current Rating—3 amperes

Termination Resistance:
 12 milliohms (max.)—Gold plated contacts
 16 milliohms (max.)—Tin plated contacts

Durability—Ref. AMP Product Specification 108-36028 and 108-36028-1

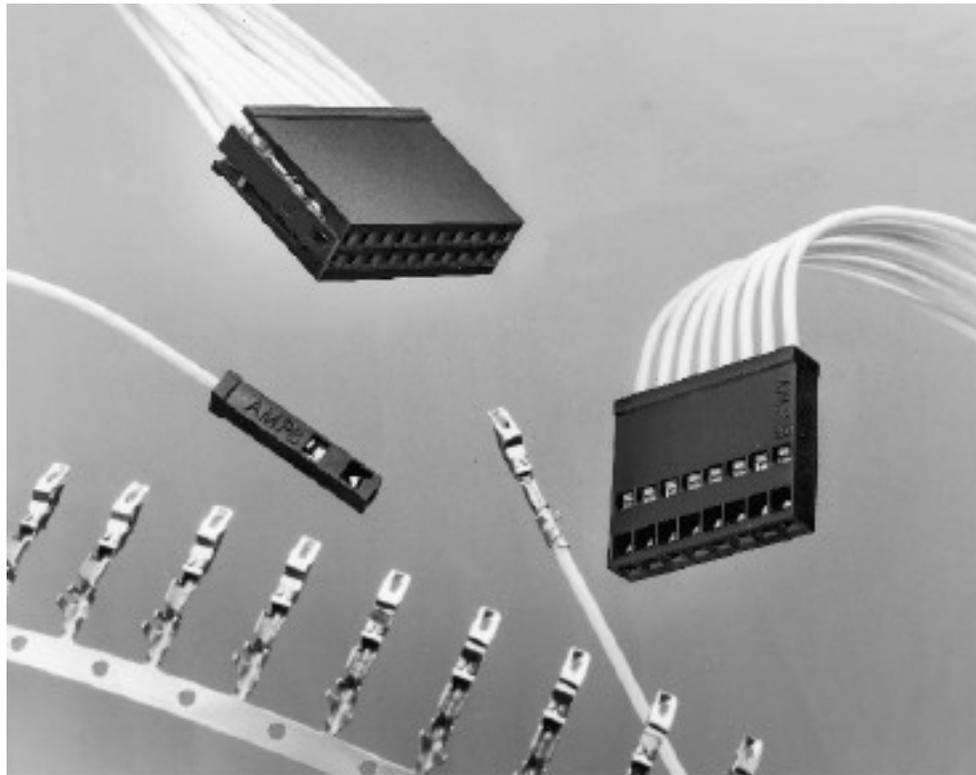

Typical Application

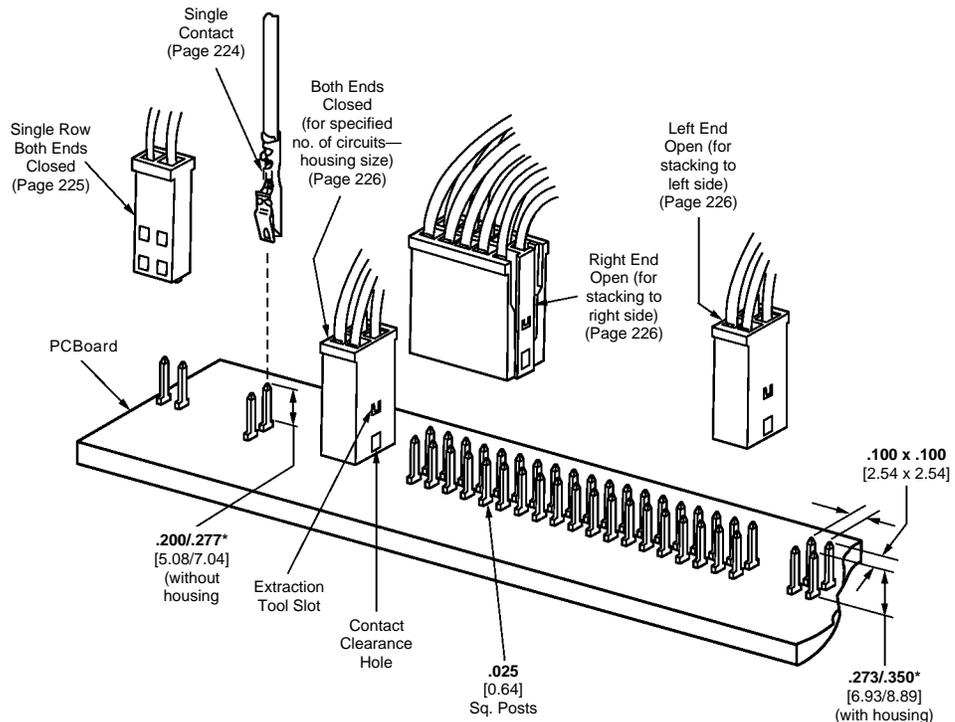

*If post is longer than maximum specified, post tip may butt against wire ends. Dimension defines .025 x .025 [0.64 x 0.64] portion of post.

Locking Clip Contacts

Wire Crimp Contacts with Insulation Support

Material and Finish:

Contact Spring—Stainless steel

Plating A—Selectively plated .000050 [0.00127] gold on contact area, with gold flash over .000050 [0.00127] nickel on entire contact

Plating B—Selectively plated .000030 [0.00076] gold on contact area, with gold flash over .000050 [0.00127] nickel on entire contact

Plating C—.000100-.000200 [0.00254-0.00508] bright tin-lead over .000050 [0.00127] nickel on entire contact

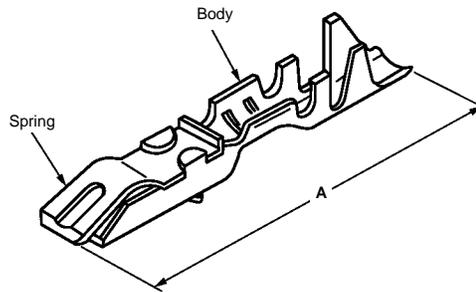

Wire Size Range		Ins. Dis. Range	Dimension A	Finish	Part Nos.		Heavy Duty Miniature Applicator for AMP-O-LECTRIC Machine*	Hand Tool No.
AWG	[mm ²]				Strip Form	Loose Piece		
30-28	0.05-0.09	.029-.039 [0.74-0.99]	.550 [13.97]	Plating B	87190-1	87191-1	567310-2	90295-1
				Plating C	87190-2	87191-2		
26-22	0.12-0.4	.038-.062 [0.97-1.57]	.584 [14.83]	Plating A	87124-3	87165-3	466721-2	91533-1
				Plating B	87124-1	87165-1		
				Plating C	87124-2	87165-2		
20	0.5-0.6	.038-.062 [0.97-1.57]	.584 [14.83]	Plating B	867052-2	—	679996-2	90431-1
				Plating C	867052-1	—		

*For use with AMP-O-LECTRIC Model "K" machines. Call the Technical Support Center (1-800-522-6752) for part nos. of applicators for use with the AMP-O-LECTRIC Model "G" machines (shown on page 289), as well as other bench machines and fully automatic AMPOMATORlead making machines.
Notes: 1. These contacts must be crimped in accordance with Tyco Electronics Specification No. 114-25006 in order to function properly in a connector housing.
 2. **Extraction Tool No. 91084-1** is used for removing individual contacts from connector housings and for detaching contacts from mating posts.

Related Product Data:

- Housings Used With**— pages 225, 226
- Application Tooling**— page 290

Technical Documents (page 295, 296):

Product Specification 108-36028, 108-36028-1

Application Specification 114-25006

Wire Harnessing

If necessary, wires can be grouped with cable ties and secured to a panel with fixed clamps. However, locking clip contacts must be free to float within the connector housings to allow proper extraction. Therefore, harnessing hardware or the use of multiple terminations per contact must not restrict the free-floating action of contacts in the housing.

For more information request Insulation and Bundling Products Catalog 124132.

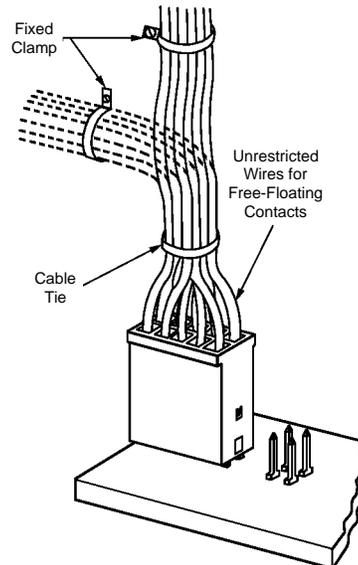

Locking Clip Contacts and Housings

5



Extraction Tool No. 91084-1

**Wire-Applied Housings for Locking Clip Contacts,
Single-Row, .100 [2.54] Centerline**

Single-Row



Material:

Glass-filled polyester, 94V-0 rated

Related Product Data:

Contacts—page 224

Mateable Headers and Posts—

Refer to the Mating Post Selection Guide—page 89

Technical Documents (pages 295, 296):

Product Specification 108-36028, 108-36028-1

Application Specification 114-25006

.125 [3.18] centerline single-row, 2 and 3 position housings are available, Base Part No. 104905. They are designed to be stackable end-to-end and side-by-side. Consult Tyco Electronics.

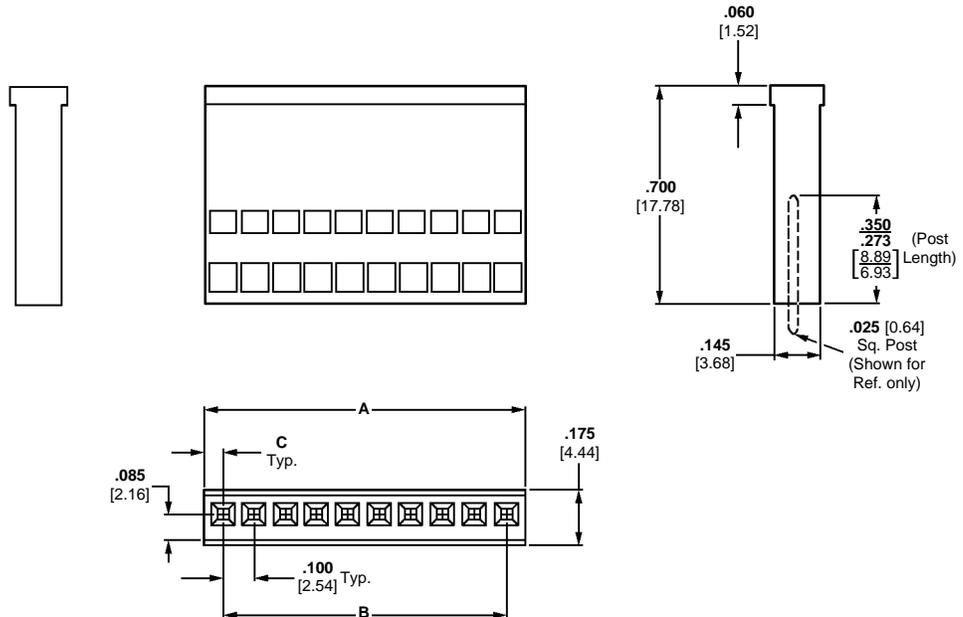

Note: Housing illustrated above is the "Both Ends Closed" version.

Keying Plug:



Part No. 87179-1

(Plugs directly into housings for .025 [0.64] square post contacts)

Material—Yellow, nylon

No. of Pos.	Dimensions			Housing Part No.	
	A	B	C	Unstamped	Stamped
1	.108 [2.74]	—	.054 [1.37]	87175-2	—
2	.216 [5.49]	.100 [2.54]	.058 [1.47]	87175-6	—
3	.316 [8.03]	.200 [5.08]	.058 [1.47]	87175-8	—
4	.416 [10.57]	.300 [7.62]	.058 [1.47]	1-87175-0	—
5	.516 [13.11]	.400 [10.16]	.058 [1.47]	1-87175-2	—
6	.616 [15.65]	.500 [12.70]	.058 [1.47]	1-87175-4	1-87175-3
7	.716 [18.19]	.600 [15.24]	.058 [1.47]	1-87175-6	1-87175-5
8	.816 [20.73]	.700 [17.78]	.058 [1.47]	1-87175-8	1-87175-7
9	.916 [23.27]	.800 [20.32]	.058 [1.47]	2-87175-0	1-87175-9
10	1.016 [25.81]	.900 [22.86]	.058 [1.47]	2-87175-2	2-87175-1
11	1.116 [28.35]	1.000 [25.40]	.058 [1.47]	2-87175-4	2-87175-3
12	1.216 [30.89]	1.100 [27.94]	.058 [1.47]	2-87175-6	2-87175-5
13	1.316 [33.43]	1.200 [30.48]	.058 [1.47]	2-87175-8	2-87175-7
14	1.416 [35.97]	1.300 [33.02]	.058 [1.47]	3-87175-0	2-87175-9
15	1.516 [38.51]	1.400 [35.56]	.058 [1.47]	87175-4	87175-3

**Wire-Applied Housings for Locking Clip Contacts,
Double-Row, .100 x .100 [2.54 x 2.54] Centerline**

Double-Row



Material:

Glass-filled polyester, 94V-0 rated

Related Product Data:

Contacts—page 224

Mateable Headers and Posts—
Refer to the Mating Post Selection
Guide—page 89

Technical Documents (pages 296,
297):

Product Specification 108-36028,
108-36028-1

Application Specification
114-25006

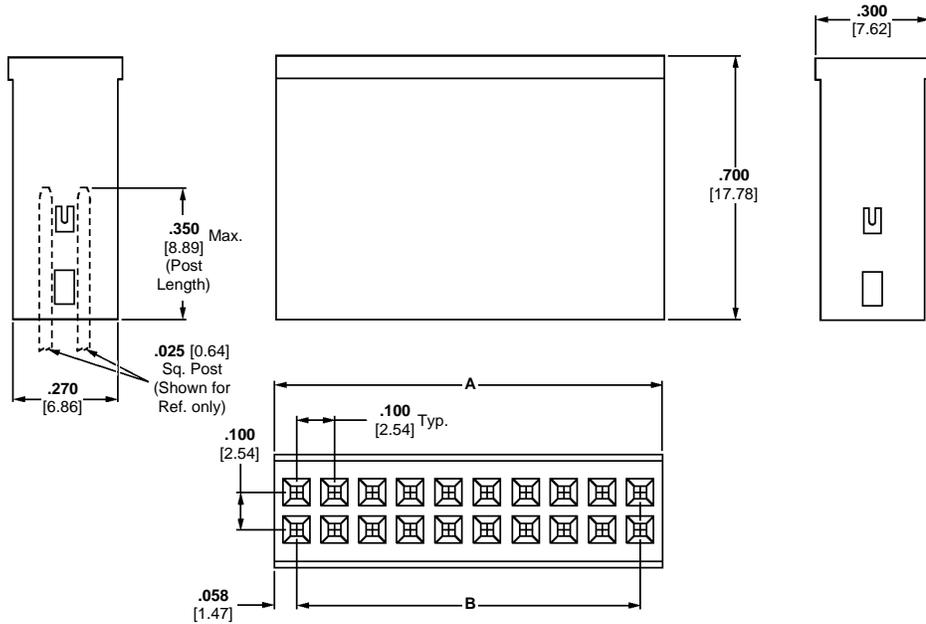

Note: Housing illustrated above is the "Both Ends Closed" version.



Both Ends Closed



Right End Open

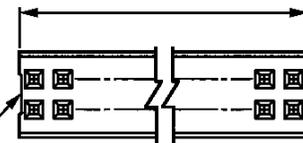

Left End Open

Key

Keyway

Keying Plug:



Part No. 87179-1

(Plugs directly into housings for
.025 [0.64] square post contacts)

Material—Yellow, nylon

Housing Configuration	No. of Pos.	Dimensions		Housing Part No.	
		A	B	Unstamped	Stamped
Both Ends Closed	2	.116 [2.95]	—	87176-2	—
	4	.216 [5.49]	.100 [2.54]	87133-1	—
	6	.316 [8.03]	.200 [5.08]	87133-7	87133-8
	8	.416 [10.57]	.300 [7.62]	87133-9	1-87133-0
	10	.516 [13.11]	.400 [10.16]	87133-2	87133-5
	12	.616 [15.65]	.500 [12.70]	1-87133-1	1-87133-2
	16	.816 [20.73]	.700 [17.78]	1-87133-3	1-87133-4
	18	.916 [23.27]	.800 [20.32]	1-87133-5	1-87133-6
	20	1.016 [25.81]	.900 [22.86]	87133-3	87133-6
	Right End Open	4	.216 [5.49]	.100 [2.54]	87132-1
10		.516 [13.11]	.400 [10.16]	87132-2	87132-5
20		1.016 [25.81]	.900 [22.86]	87132-3	87132-6
Left End Open	4	.216 [5.49]	.100 [2.54]	87131-1	—
	10	.516 [13.11]	.400 [10.16]	87131-2	87131-5
	20	1.016 [25.81]	.900 [22.86]	87131-3	87131-6

Locking Clip Contacts and Housings

5

Mod IV Wire-Applied Contacts and Housings

Product Facts

- Terminates 32-20 AWG [0.03-0.6mm²] discrete wire
- Contacts have insulation support
- Choice of three contact mating pressures
- Available in a variety of gold and tin platings
- Receptacles mate with .025 [0.64] square or round posts
- Dual cantilever contact beam with built-in anti-overstress feature for reliable matings
- Housings accept a variety of receptacle and pin contacts
- Housing sizes range up to 100 positions
- Housing configurations include single- and double-rows on .100 [2.54] centerlines
- Housing options include detent latching, polarization and bonded strain relief/pull tabs
- Recognized under the Component Program of Underwriters Laboratories Inc., File No. E28476
- Certified by Canadian Standards Association,



Performance Characteristics

Contact Current Rating—3 amperes

Termination Resistance:
12 milliohms (max.)—Beryllium copper contacts

20 milliohms (max.)—Copper-tin-phosphor bronze contacts

Durability—Ref. AMP Product Specification 108-25020

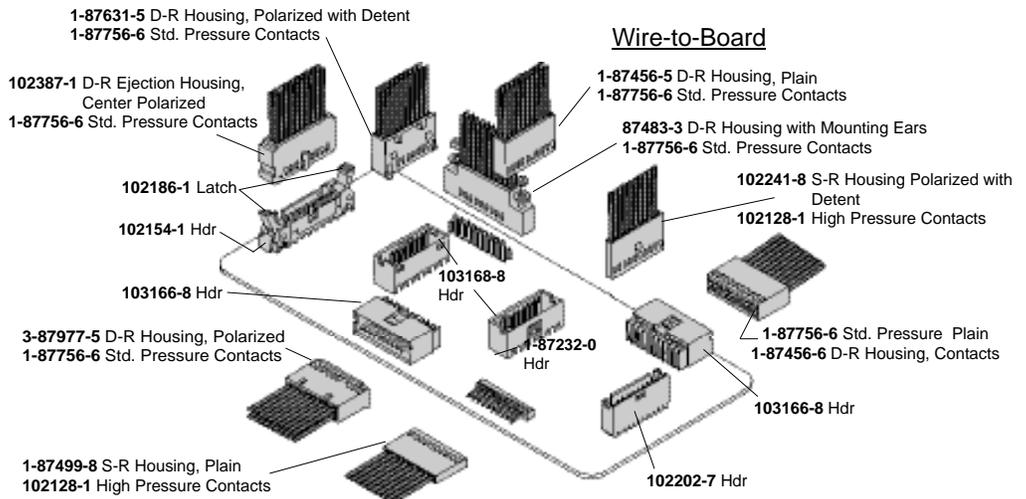
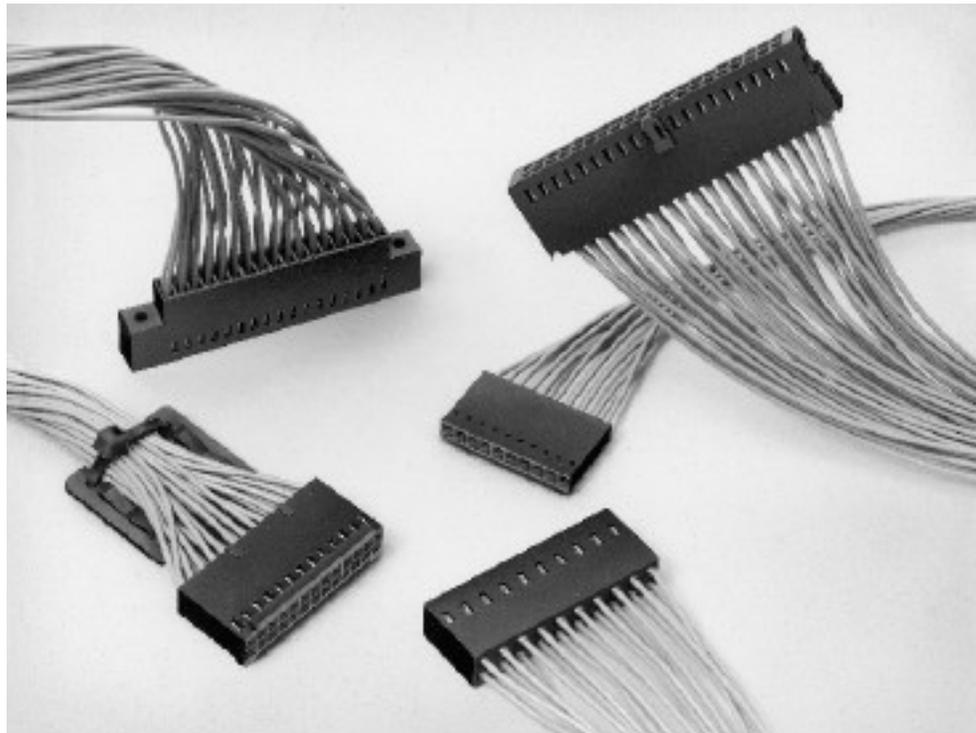

Mod IV Wire-Applied Contacts and Housings

5

Mod IV Pin and Receptacle Contacts

Crimp Snap-In (No-strip) Receptacles and Crimp Snap-In Pins with Insulation Support (Standard Pressure)

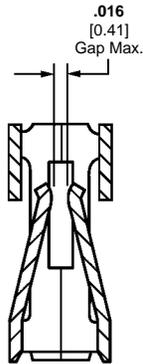

Standard Pressure Configuration

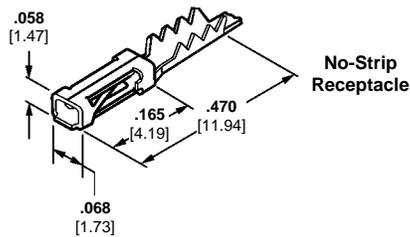

No-Strip Receptacle

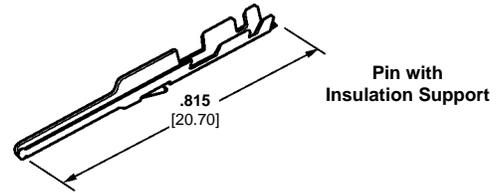

Pin with Insulation Support

Crimp Snap-In (No-strip) Receptacles

Ins. Dia. Range	Finish	Part Nos.		Heavy Duty Miniature Applicator No. for AMP-O-LECTRIC Machine*	Hand Tool Part No.
		Strip Form	Loose Piece		
.040-.055 [1.02-1.40]	Plating A	87107-5	102348-2	567307-2	90381-1
	Plating C	87107-6	102348-3		

Material and Finish:

Beryllium copper or phosphor bronze (see charts), plated as follows:

Plating A—Selectively plated .000030 [0.00076] gold on contact area, with gold flash over .000050 [0.00127] nickel on entire contact

Plating B—Selectively plated .000015 [0.00038] gold on contact area, with gold flash over .000050 [0.00127] nickel on entire contact

Plating C—.000100-.000200 [0.00254-0.00508] bright tin-lead over .000030 [0.00076] nickel on entire contact

Crimp Snap-In Pins with Insulation Support

Wire Size Range		Ins. Dia. (Max.)	Finish	Part Nos.		Heavy Duty Miniature Applicator No. for AMP-O-LECTRIC Machine*	Hand Tool Part No.	
AWG	[mm ²]			Strip Form	Loose Piece		Premium	Commercial
26-22	0.12-0.4	.061 [1.55]	Plating A	102095-3	102107-2	466812-2	91517-1	58641-1†
			Plating B	102095-2	102107-1			
			Plating C	102095-4	102107-3			

*For use with AMP-O-LECTRIC Model "K" machines. Call the Technical Support Center (1-800-522-6752) for part nos. of applicators for use with the AMP-O-LECTRIC Model "G" machines (shown on page 289), as well as other bench machines and fully automatic AMPOMATORlead making machines.

†PRO-CRIMPER II hand tool frame with die set assembly. Die Set Part No. 58641-2

Related Product Data:

Housings Used With— pages 231-237

Performance Characteristics— page 227

Application Tooling— page 290

Technical Documents (pages 294, 296):

Product Specification 108-25007, 208-25019, 108-25020, 108-25021

Application Specification 114-25003, 114-25016

Additional header sizes are available; minimum order quantities may apply. Consult Tyco Electronics.

Mod IV Receptacle Contacts

Crimp Snap-In Receptacles with Insulation Support (Standard, Intermediate and High Pressure)

Material and Finish:

Beryllium copper, phosphor bronze or copper-tin-phosphor bronze (see charts, page 139), plated as follows:

Plating A—Duplex plated .000030 [0.00076] gold on contact area, .000100-.000200 [0.00254-0.00508] tin-lead on crimp area, with entire contact underplated .000050 [0.00127] nickel

Plating B—Duplex plated .000015 [0.00038] gold on contact area, .000100-.000200 [0.00254-0.00508] tin-lead in crimp area, with entire contact underplated .000050 [0.00127] nickel

Plating D—Selectively plated .000050 [0.00127] gold on contact area, with gold flash over .000050 [0.00127] nickel on entire contact

Plating E—Selectively plated .000030 [0.00076] gold on contact area, with gold flash over .000050 [0.00127] nickel on entire contact

Plating F—Selectively plated .000015 [0.00038] gold on contact area, with gold flash over .000050 [0.00127] nickel on entire contact

Plating G—.000100-.000200 [0.00254-0.00508] bright tin-lead over .000030 [0.00076] nickel on entire contact

Related Product Data:

Housings Used With— pages 231-237

Performance Characteristics— page 227

Application Tooling— page 290

Technical Documents (pages 294, 296):

Product Specification 108-25007, 208-25019, 108-25020, 108-25021

Application Specification 114-25003, 114-25016

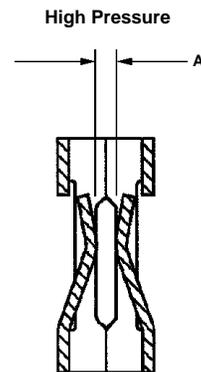
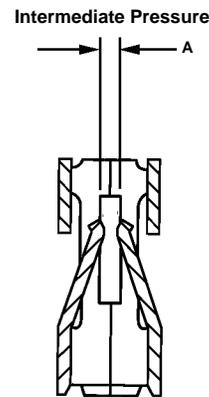
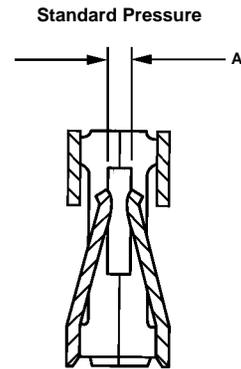
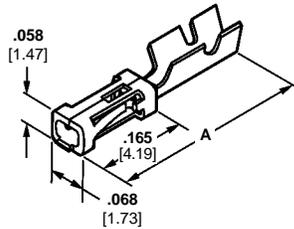

	Mating Force	Unmating Force	A-Gap Dimension
Standard Pressure	9 oz. Max.	1.5 oz. Min.	.008/.014
Intermediate Pressure	16 oz. Max.	2 oz. Min.	.008/.014
High Pressure	20 oz. Max.	3 oz. Min.	.013±.002

Mod IV Receptacle Contacts (Continued)

Standard Pressure (Mod IV)

Wire Size Range AWG [mm ²]	Ins. Dia. (Max.)	Dimension A	Material	Finish	Part Nos.		Heavy Duty Miniature Applicator for AMP-O-LECTRIC Machine*	Applicator for Stripper/Crimper Machine	Hand Tool Part Nos.	
					Strip Form	Loose Piece			Premium	Commercial
32-27 0.03-0.1	.040 [1.02]	.445 [11.30]	Cu-Sn-PhBz	Plating A	102316-8	1-102316-4	466655-2	466921-1	91541-1	—
			Cu-Sn-Ph Bz	Plating B	102316-6	1-102316-3				
			Be Cu	Plating D	1-102917-1	1-102917-2				
			Be Cu	Plating E	102917-1	102917-2				
			Be Cu	Plating F	102917-5	102917-6				
			Cu-Sn-PhBz	Plating G	102316-5	1-102316-2				
26-22 0.12-0.4	.061 [1.55]	.445 [11.30]	Cu-Sn-PhBz	Plating A	1-87756-7	1-87756-8	466571-2	466918-1	91517-1	58641-1†
			Cu-Sn-Ph Bz	Plating B	1-87756-2	1-87756-6				
			Cu-Sn-Ph Br	Plating G	87756-6	87756-7				
			Be Cu	Plating D	1-87666-6	87667-5				
			Be Cu	Plating E	87666-2	87667-2				
			Be Cu	Plating F	87666-5	87667-5				
24-20 0.2-0.6	.069 [1.75]	.470 [11.94]	Cu-Sn-PhBz	Plating A	1-87523-8	1-87523-9	466562-2	466905-1	91516-2	—
			Cu-Sn-Ph Bz	Plating B	1-87523-5	1-87523-6				
			Be Cu	Plating E	85969-8	86016-2				
			Be Cu	Plating F	85969-6	86016-5				
			Cu-Sn-Ph Br	Plating G	87523-5	87523-6				
			Be Cu	Plating G	85969-9	86016-3				

Intermediate Pressure (Mod IV.v)

Wire Size Range AWG [mm ²]	Ins. Dia. (Max.)	Dimension A	Material	Finish	Part Nos.		Heavy Duty Miniature Applicator for AMP-O-LECTRIC Machine*	Applicator for Stripper/Crimper Machine	Hand Tool Part Nos.	
					Strip Form	Loose Piece			Premium	Commercial
32-27 0.03-0.1	.040 [1.02]	.445 [11.30]	Cu-Sn-Ph Bz	Plating A	102920-1	102920-2	466655-2	466921-1	91541-1	—
			Be Cu	Plating E	102918-1	102918-2				
26-22 0.12-0.4	.061 [1.55]	.445 [11.30]	Cu-Sn-PhBz	Plating A	103171-4	103171-5	466571-2	466918-1	91517-1	58641-1†
			Cu-Sn-Ph Bz	Plating B	103171-1	103171-2				
			Be Cu	Plating E	102548-5	102548-6				
24-20 0.2-0.6	.069 [1.75]	.470 [11.94]	Be Cu	Plating F	102548-1	102548-3	466562-2	466905-1	91516-1	—
			Cu-Sn-PhBz	Plating A	2-87195-0	2-87195-1				
			Cu-Sn-Ph Bz	Plating B	1-87195-7	1-87195-8				
			Be Cu	Plating E	86492-6	87046-3				
			Be Cu	Plating F	86492-2	87046-1				
Be Cu	Plating G	86492-9	87046-4							

High Pressure (Mod V)**

Wire Size Range AWG [mm ²]	Ins. Dia. (Max.)	Dimension A	Material	Finish	Part Nos.		Heavy Duty Miniature Applicator for AMP-O-LECTRIC Machine*	Applicator for AMP-O-MATIC Stripper/Crimper Machine	Hand Tool Part Nos.
					Strip Form	Loose Piece			
32-27 0.03-0.1	.040 [1.02]	.445 [11.30]	Ph Bz	Plating E	103455-1	103455-2	466655-2	466921-1	91541-1
26-22 0.12-0.4	.061 [1.55]	.445 [11.30]	Ph Bz	Plating E	87809-1	102128-1	466571-2	466918-1	91517-1
			Ph Bz	Plating G	87809-2	102128-2			
24-20 0.2-0.6	.069 [1.75]	.470 [11.94]	Ph Bz	Plating E	87309-9	1-87309-4	466562-2	466905-1	91516-1
			Ph Bz	Plating G	87309-8	1-87309-3			

*For use with AMP-O-LECTRIC Model "K" machines. Call the Technical Support Center (1-800-522-6752) for part nos. of applicators for use with the AMP-O-LECTRIC Model "G" machines (shown on page 289), as well as other bench machines and fully automatic AMPOMATORlead making machines.

**Contact material is phosphor bronze.

†PRO-CRIMPER II hand tool frame with die set assembly.
Die Set Part No. 58641-2

Mod IV Contacts

5

Mod IV Wire-Applied Housings, Single-Row, .100 [2.54] Centerline

Non-Polarized



Material:

Black thermoplastic, flame retardant

Related Product Data:

Contacts—pages 228-230

Mateable Headers and Posts—pages 92-94, 100-104, 110-112

Technical Documents (page 294-296):

Product Specification 108-25007, 208-25019, 108-25020, 108-25021

Application Specification 114-25003, 114-25016

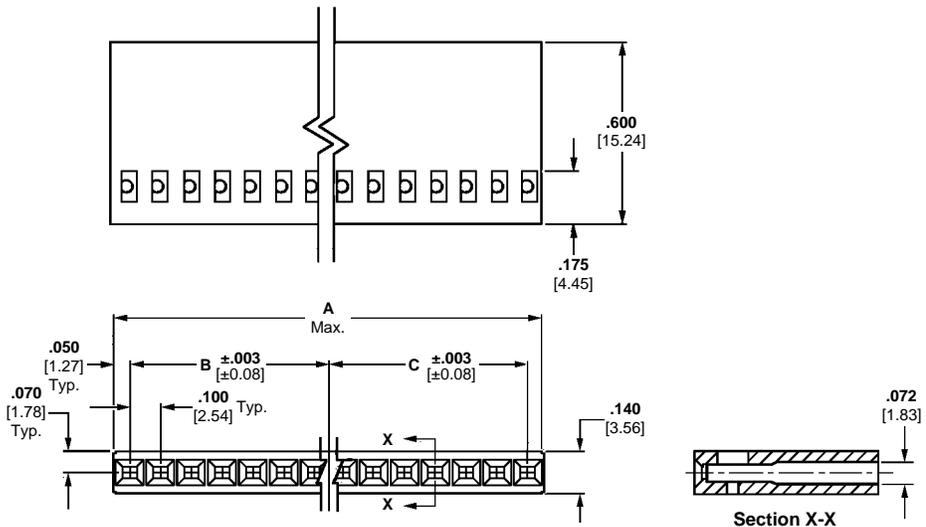

Keying Plugs

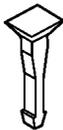

Part No. 86286-1

(Plugs into standard or intermediate pressure receptacle contact)

Material—Natural color nylon



Part No. 87077-2

(Plugs directly into housing)

No. of Pos.	Dimensions			Part No.	
	A	B	C	Stamped*	Unstamped**
1	.105 [2.67]	—	—	—	7-87499-2
2	.205 [5.21]	.100 [2.54]	—	87499-3	87499-4
3	.305 [7.75]	.100 [2.54]	.100 [2.54]	87499-5	87499-6
4	.405 [10.29]	.200 [5.08]	.100 [2.54]	87499-7	87499-8
5	.505 [12.83]	.200 [5.08]	.200 [5.08]	87499-9	1-87499-0
6	.605 [15.37]	.300 [7.62]	.200 [5.08]	1-87499-1	1-87499-2
7	.705 [17.91]	.300 [7.62]	.300 [7.62]	87499-1	87499-2
8	.805 [20.45]	.400 [10.16]	.300 [7.62]	1-87499-3	1-87499-4
9	.905 [22.99]	.400 [10.16]	.400 [10.16]	1-87499-5	1-87499-6
10	1.005 [25.53]	.500 [12.70]	.400 [10.16]	1-87499-7	1-87499-8
11	1.105 [28.01]	.500 [12.70]	.500 [12.70]	1-87499-9	2-87499-0
12	1.205 [30.61]	.600 [15.24]	.500 [12.70]	2-87499-1	2-87499-2
13	1.305 [33.15]	.600 [15.24]	.600 [15.24]	2-87499-3	2-87499-4
14	1.405 [35.69]	.700 [17.78]	.600 [15.24]	2-87499-5	2-87499-6
15	1.505 [38.23]	.700 [17.78]	.700 [17.78]	2-87499-7	2-87499-8
16	1.605 [40.77]	.800 [20.32]	.700 [17.78]	2-87499-9	3-87499-0
17	1.700 [43.18]	.800 [20.32]	.800 [20.32]	—	3-87499-2
18	1.805 [45.85]	.900 [22.86]	.800 [20.32]	—	3-87499-4
19	1.900 [48.26]	.900 [22.86]	.900 [22.86]	—	3-87499-6
20	2.005 [50.93]	1.000 [25.40]	.900 [22.86]	3-87499-7	3-87499-8
21	2.100 [53.34]	1.000 [25.40]	1.000 [25.40]	—	4-87499-0
22	2.205 [56.01]	1.100 [27.94]	1.000 [25.40]	—	4-87499-2
23	2.300 [58.42]	1.100 [27.94]	1.100 [27.94]	—	4-87499-4
24	2.400 [60.96]	1.200 [30.48]	1.100 [27.94]	—	4-87499-6
25	2.500 [63.50]	1.200 [30.48]	1.200 [30.48]	—	4-87499-8
26	2.605 [66.17]	1.300 [33.02]	1.200 [30.48]	—	5-87499-0
27	2.700 [68.58]	1.300 [33.02]	1.300 [33.02]	—	5-87499-2
28	2.800 [71.12]	1.400 [35.56]	1.300 [33.02]	—	5-87499-4
29	2.900 [73.66]	1.400 [35.56]	1.400 [35.56]	—	5-87499-6
30	3.005 [76.33]	1.500 [38.10]	1.400 [35.56]	—	5-87499-8
31	3.100 [78.74]	1.500 [38.10]	1.500 [38.10]	—	6-87499-0
32	3.200 [81.28]	1.600 [40.64]	1.500 [38.10]	—	6-87499-2
33	3.300 [83.82]	1.600 [40.64]	1.600 [40.64]	—	6-87499-4
34	3.400 [86.36]	1.700 [43.18]	1.600 [40.64]	—	6-87499-6
35	3.500 [88.98]	1.700 [43.18]	1.700 [43.18]	—	6-87499-8
36	3.600 [91.44]	1.800 [45.72]	1.700 [43.18]	—	7-87499-0

*Cavity identification, part number and date code stamped on housing where size permits.

**No marking on housing.

Notes: 1. Strain reliefs are available and may be purchased separately. Consult Tyco Electronics.
2. Contact Extraction/Lance Reset Tool No. 843996-3.

Mod IV Wire-Applied Housings, Single-Row, .100 [2.54] Centerline (Continued)

Polarized (with Detent Latching)

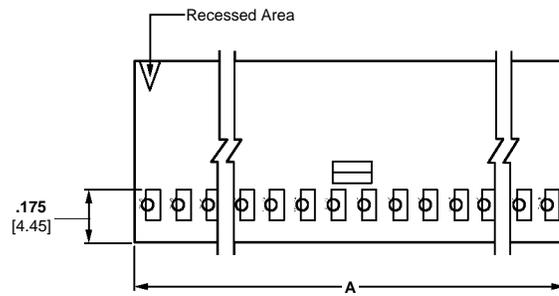

Material:

Black thermoplastic, flame retardant

Related Product Data:

- Contacts**—pages 228-230
- Mateable Headers and Posts**—pages 129-131
- Flexible Film Connectors, Single-Row Pin Assemblies**—Catalog 82007

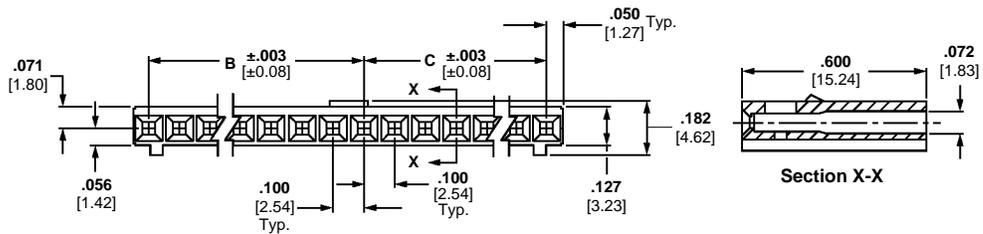

Technical Documents: (pages 294, 296):

- Product Specification** 108-25007, 208-25019, 108-25020, 108-25021
- Application Specification** 114-25003, 114-25016

No. of Pos.	Dimensions			Part Nos. Unstamped*
	A	B	C	
3	.300 [7.62]	.100 [2.54]	.100 [2.54]	102241-1
4	.400 [10.16]	.200 [5.08]	.100 [2.54]	102241-2
5	.500 [12.70]	.200 [5.08]	.200 [5.08]	102241-3
6	.600 [15.24]	.300 [7.62]	.200 [5.08]	102241-4
7	.700 [17.78]	.300 [7.62]	.300 [7.62]	102241-5
8	.800 [20.32]	.400 [10.16]	.300 [7.62]	102241-6
9	.900 [22.86]	.400 [10.16]	.400 [10.16]	102241-7
10	1.000 [25.40]	.500 [12.70]	.400 [10.16]	102241-8
11	1.100 [27.94]	.500 [12.70]	.500 [12.70]	102241-9
12	1.200 [30.48]	.600 [15.24]	.500 [12.70]	1-102241-0
13	1.300 [33.02]	.600 [15.24]	.600 [15.24]	1-102241-1
14	1.400 [35.56]	.700 [17.78]	.600 [15.24]	1-102241-2
15	1.500 [38.10]	.700 [17.78]	.700 [17.78]	1-102241-3
16	1.600 [40.64]	.800 [20.32]	.700 [17.78]	1-102241-4
17	1.700 [43.18]	.800 [20.32]	.800 [20.32]	1-102241-5
18	1.800 [45.72]	.900 [22.86]	.800 [20.32]	1-102241-6
19	1.900 [48.26]	.900 [22.86]	.900 [22.86]	1-102241-7
20	2.000 [50.80]	1.000 [25.40]	.900 [22.86]	1-102241-8
21	2.100 [53.34]	1.000 [25.40]	1.000 [25.40]	1-102241-9
22	2.200 [55.88]	1.100 [27.94]	1.000 [25.40]	2-102241-0
23	2.300 [58.42]	1.100 [27.94]	1.100 [27.94]	2-102241-1
24	2.400 [60.96]	1.200 [30.48]	1.100 [27.94]	2-102241-2
25	2.500 [63.50]	1.200 [30.48]	1.200 [30.48]	2-102241-3
26	2.600 [66.04]	1.300 [33.02]	1.200 [30.48]	2-102241-4
27	2.700 [68.58]	1.300 [33.02]	1.300 [33.02]	2-102241-5
28	2.800 [71.12]	1.400 [35.56]	1.300 [33.02]	2-102241-6
29	2.900 [73.66]	1.400 [35.56]	1.400 [35.56]	2-102241-7
30	3.000 [76.20]	1.500 [38.10]	1.400 [35.56]	2-102241-8
31	3.100 [78.74]	1.500 [38.10]	1.500 [38.10]	2-102241-9
32	3.200 [81.28]	1.600 [40.64]	1.500 [38.10]	3-102241-0
33	3.300 [83.82]	1.600 [40.64]	1.600 [40.64]	3-102241-1
34	3.400 [86.36]	1.700 [43.18]	1.600 [40.64]	3-102242-2
35	3.500 [88.90]	1.700 [43.18]	1.700 [43.18]	3-102241-3
36	3.600 [91.44]	1.800 [45.72]	1.700 [43.18]	3-102241-4

*No marking on housing.

Note: Contact Extraction/Lance Reset Tool No. 843996-3.

Keying Plugs

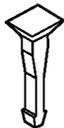

Part No. 86286-1

(Plugs into standard or intermediate pressure receptacle contact)

Material—Natural color nylon



Part No. 87077-2

(Plugs directly into housing)

Mod IV Wire-Applied Housings

5

Mod IV Wire-Applied Housings, Double-Row, .100 x .100 [2.54 x 2.54] Centerline

Non-Polarized

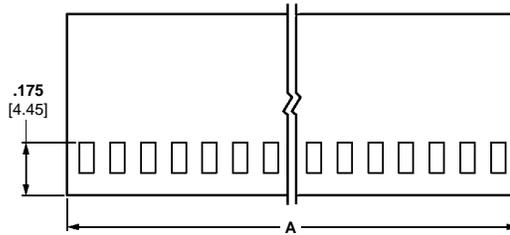
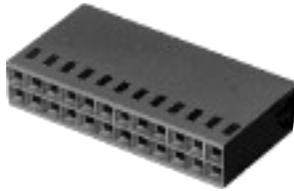

Material:

Black thermoplastic, flame retardant

Related Product Data:

Contacts—pages 228-230

Mateable Headers and Posts—pages 95-97, 105-109, 133-135

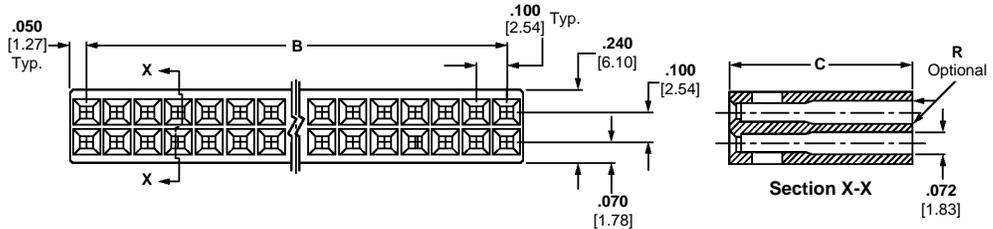

Technical Documents (pages 294, 296):

Product Specification 108-25007, 208-25019, 108-25020, 108-25021

Application Specification 114-25003, 114-25016

No. of Pos.	Dimensions		Part Nos.		
	A	B	C = .600 [15.24]		C = .645 [16.38]
			Stamped*	Unstamped**	Unstamped**
2	.100 [2.54]	—	—	5-87456-3	—
4	.200 [5.08]	.100 [2.54]	5-87456-0	4-87456-9	2-86177-5
6	.300 [7.62]	.200 [5.08]	87456-2	87456-1	1-86177-8
8	.400 [10.16]	.300 [7.62]	87456-4	87456-3	2-86177-0
10	.500 [12.70]	.400 [10.16]	87456-6	87456-5	1-86177-2
12	.600 [15.24]	.500 [12.70]	87456-8	87456-7	1-86177-3
14	.700 [17.78]	.600 [15.24]	1-87456-0	87456-9	1-86177-4
16	.800 [20.32]	.700 [17.78]	1-87456-2	1-87456-1	1-86177-5
18	.900 [22.86]	.800 [20.32]	1-87456-4	1-87456-3	1-86177-6
20	1.000 [25.40]	.900 [22.86]	1-87456-6	1-87456-5	86177-1
22	1.100 [27.94]	1.000 [25.40]	—	1-87456-7	86177-2
24	1.200 [30.48]	1.100 [27.94]	2-87456-0	1-87456-9	86177-3
26	1.300 [33.02]	1.200 [30.48]	2-87456-2	2-87456-1	86177-4
28	1.400 [35.56]	1.300 [33.02]	2-87456-4	2-87456-3	86177-5
30	1.500 [38.10]	1.400 [35.56]	2-87456-6	2-87456-5	86177-6
32	1.600 [40.64]	1.500 [38.10]	2-87456-8	2-87456-7	86177-7
34	1.700 [43.18]	1.600 [40.64]	3-87456-0	2-87456-9	86177-8
36	1.800 [45.72]	1.700 [43.18]	3-87456-2	3-87456-1	86177-9
38	1.900 [48.26]	1.800 [45.72]	—	3-87456-3	1-86177-0
40	2.000 [50.80]	1.900 [48.26]	3-87456-6	3-87456-5	1-86177-1
42	2.100 [53.34]	2.000 [50.80]	4-87456-4	4-87456-3	—
44	2.200 [55.88]	2.100 [53.34]	3-87456-8	3-87456-7	1-86177-7
48	2.400 [60.96]	2.300 [58.42]	6-87456-0	5-87456-9	2-86177-3
50	2.500 [63.50]	2.400 [60.96]	4-87456-0	3-87456-9	2-86177-1
52	2.600 [66.04]	2.500 [63.50]	4-87456-2	4-87456-1	1-86177-9
54	2.700 [68.58]	2.600 [66.04]	—	4-87456-5	—
56	2.800 [71.12]	2.700 [68.58]	—	6-87456-1	—
58	2.900 [73.66]	2.800 [71.12]	—	6-87456-3	—
60	3.000 [76.20]	2.900 [73.66]	5-87456-2	5-87456-1	—
64	3.200 [81.28]	3.100 [78.74]	6-87456-6	6-87456-5	—
66	3.300 [83.82]	3.200 [81.28]	5-87456-4	5-87456-7	—
70	3.500 [88.90]	3.400 [86.36]	—	5-87456-5	2-86177-4
72	3.600 [91.44]	3.500 [88.90]	4-87456-8	4-87456-7	—

Keying Plugs

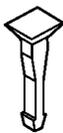

Part No. 86286-1

(Plugs into standard or intermediate pressure receptacle contact)

Material—Natural color nylon

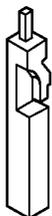

Part No. 87077-1

(for .645 high housings)

Part No. 87077-2

(for .600 high housings)
(Plugs directly into housing)

*Cavity identification, AMP, part number and date code stamped on housing where size permits.

**No marking on housing.

Notes: 1. Strain reliefs are available and may be purchased separately. Consult Tyco Electronics.

2. Contact **Extraction/Lance Reset Tool No. 843996-3**.

Mod IV Wire-Applied Housings, Double-Row, .100 x .100 [2.54 x 2.54] Centerline (Continued)

Polarized



Material:

Black thermoplastic, flame retardant

Related Product Data:

Contacts—pages 228-230

Mateable Headers and Posts—pages 133-148

Technical Documents (pages 294, 296):

Product Specification 108-25007, 208-25019, 108-25020, 108-25021

Application Specification 114-25003, 114-25016

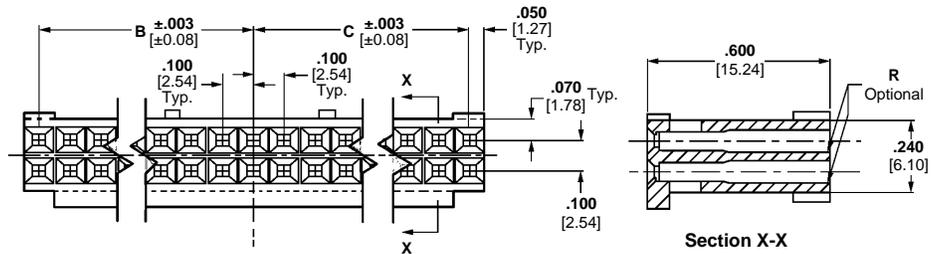
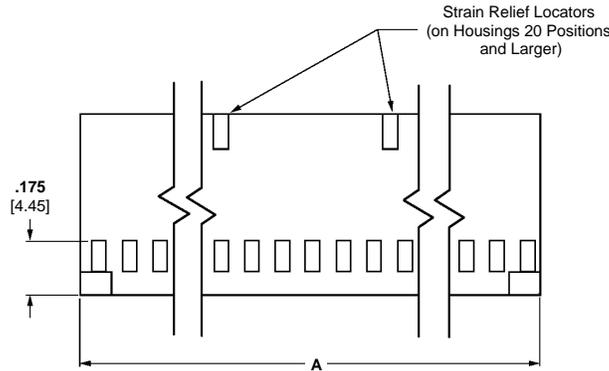

No. of Pos.	Dimensions			Part Nos.	
	A	B	C	Stamped*	Unstamped**
6	.300 [7.62]	.100 [2.54]	.100 [2.54]	87977-1	2-87977-8
8	.400 [10.16]	.200 [5.08]	.100 [2.54]	87977-2	2-87977-9
10	.500 [12.70]	.200 [5.08]	.200 [5.08]	87977-3	3-87977-0
12	.600 [15.24]	.300 [7.62]	.200 [5.08]	87977-4	3-87977-1
14	.700 [17.78]	.300 [7.62]	.300 [7.62]	87977-5	3-87977-2
16	.800 [20.32]	.400 [10.16]	.300 [7.62]	87977-6	3-87977-3
18	.900 [22.86]	.400 [10.16]	.400 [10.16]	—	3-87977-4
20	1.000 [25.40]	.500 [12.70]	.400 [10.16]	87977-8	3-87977-5
22	1.100 [27.94]	.500 [12.70]	.500 [12.70]	—	3-87977-6
24	1.200 [30.48]	.600 [15.24]	.500 [12.70]	1-87977-0	3-87977-7
26	1.300 [33.02]	.600 [15.24]	.600 [15.24]	1-87977-1	3-87977-8
28	1.400 [35.56]	.700 [17.78]	.600 [15.24]	—	3-87977-9
30	1.500 [38.10]	.700 [17.78]	.700 [17.78]	—	4-87977-0
32	1.600 [40.64]	.800 [20.32]	.700 [17.78]	—	4-87977-1
34	1.700 [43.18]	.800 [20.32]	.800 [20.32]	—	4-87977-2
36	1.800 [45.72]	.900 [22.86]	.800 [20.32]	—	4-87977-3
38	1.900 [48.26]	.900 [22.86]	.900 [22.86]	—	4-87977-4
40	2.000 [50.80]	1.000 [25.40]	.900 [22.86]	1-87977-8	4-87977-5
42	2.100 [53.34]	1.000 [25.40]	1.000 [25.40]	—	4-87977-6
44	2.200 [55.88]	1.100 [27.94]	1.000 [25.40]	—	4-87977-7
48	2.400 [60.96]	1.200 [30.48]	1.100 [27.94]	—	5-87977-6
50	2.500 [63.50]	1.200 [30.48]	1.200 [30.48]	2-87977-1	4-87977-8
52	2.600 [66.04]	1.300 [33.02]	1.200 [30.48]	—	4-87977-9
54	2.700 [68.58]	1.300 [33.02]	1.300 [33.02]	—	5-87977-0
56	2.800 [71.12]	1.400 [35.56]	1.300 [33.02]	—	5-87977-8
58	2.900 [73.66]	1.400 [35.56]	1.400 [35.56]	—	6-87977-0
60	3.000 [76.20]	1.500 [38.10]	1.400 [35.56]	2-87977-4	5-87977-1
64	3.200 [81.28]	1.600 [40.64]	1.500 [38.10]	—	6-87977-2
66	3.300 [83.82]	1.600 [40.64]	1.600 [40.64]	—	5-87977-2
70	3.500 [88.90]	1.700 [43.18]	1.700 [43.18]	—	5-87977-3
72	3.600 [91.44]	1.800 [45.72]	1.700 [43.18]	—	5-87977-4

*Cavity identification, AMP, part number and date code stamped on housing where size permits.

**No marking on housing or strain relief.

Notes: 1. Strain reliefs are available and may be purchased separately. Consult Tyco Electronics.
2. Contact Extraction/Lance Reset Tool No. 843996-3.

Keying Plugs

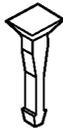

Part No. 86286-1

(Plugs into standard or intermediate pressure receptacle contact)

Material—Natural color nylon



Part No. 87077-2

(Plugs directly into housing)

Mod IV Wire-Applied Housings, Double-Row, .100 x .100 [2.54 x 2.54] Centerline (Continued)

Polarized (with Detent Latching, with and without Strain Relief/Pull Tab)



Material:

Black thermoplastic, flame retardant

Related Product Data:

Contacts—pages 228-230

Mateable Headers and Posts—pages 133-141, 144-149

Technical Documents (pages 294, 296):

Product Specification 108-25007, 208-25019, 108-25020, 108-25021

Application Specification 114-25003, 114-25016

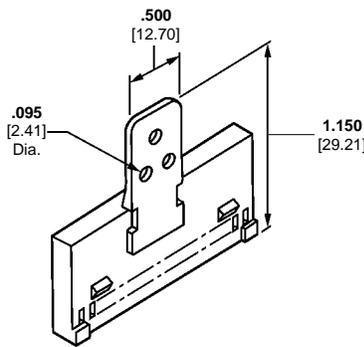
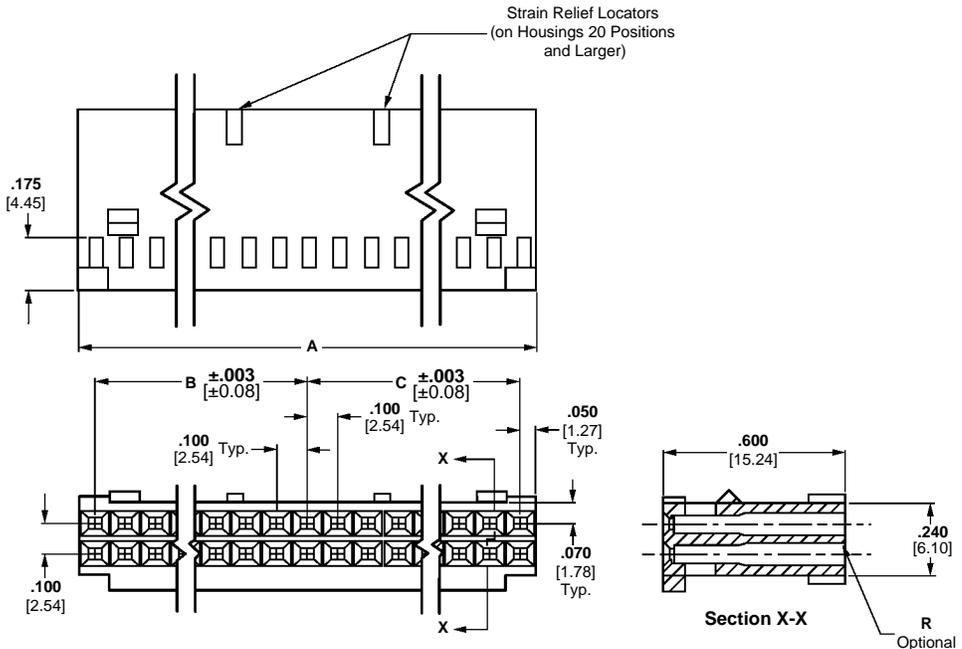

Housing with Strain Relief/Pull Tab
Strain Relief Part No. 87921-1
(10 thru 18 positions)

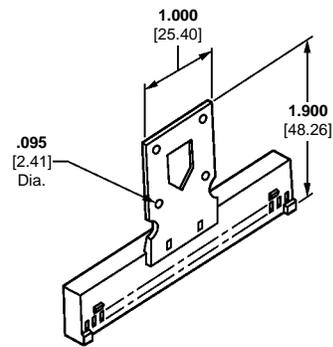

Housing with Strain Relief/Pull Tab
Strain Relief Part No. 87710-1
(20 positions and larger)

Keying Plugs

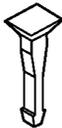

Part No. 86286-1

(Plugs into standard or intermediate pressure receptacle contact)

Material—Natural color nylon

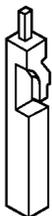

Part No. 87077-2

(Plugs directly into housing)

No. of Pos.	Dimensions			No. of Detents	Part Nos.		
	A	B	C		Without Strain Relief Stamped*	With Strain Relief Unstamped**	With Strain Relief Stamped*
6	.300 [7.62]	.100 [2.54]	.100 [2.54]	1	87631-2	87631-1	—
8	.400 [10.16]	.200 [5.08]	.100 [2.54]	1	87631-4	87631-3	—
10	.500 [12.70]	.200 [5.08]	.200 [5.08]	1	87631-6	87631-5	87922-1
12	.600 [15.24]	.300 [7.62]	.200 [5.08]	1	87631-8	87631-7	87922-2
14	.700 [17.78]	.300 [7.62]	.300 [7.62]	1	1-87631-0	87631-9	87922-3
16	.800 [20.32]	.400 [10.16]	.300 [7.62]	1	1-87631-2	1-87631-1	87922-4

*Cavity identification, AMP, part number and date code stamped on housing and/or strain relief where size permits.

**No marking on housing or strain relief.

- Notes:**
1. The Strain Relief/Pull Tab can be bonded to any thermoplastic connector housing.
 2. Strain reliefs may be purchased separately.
 3. Contact **Extraction/Lance Reset Tool No. 843996-3**.

**Mod IV Wire-Applied Housings, Double-Row,
.100 x .100 [2.54 x 2.54] Centerline** (Continued)

No. of Pos.	Dimensions			No. of Detents	Part Nos.		
	A	B	C		Without Strain Relief		With Strain Relief
					Stamped*	Unstamped**	Stamped*
18	.900 [22.86]	.400 [10.16]	.400 [10.16]	1	1-87631-4	1-87631-3	87922-5
20	1.000 [25.40]	.500 [12.70]	.400 [10.16]	2	1-87631-6	1-87631-5	87733-1
22	1.100 [27.94]	.500 [12.70]	.500 [12.70]	2	1-87631-8	1-87631-7	—
24	1.200 [30.48]	.600 [15.24]	.500 [12.70]	2	2-87631-0	1-87631-9	87733-3
26	1.300 [33.02]	.600 [15.24]	.600 [15.24]	2	2-87631-2	2-87631-1	87733-4
28	1.400 [35.56]	.700 [17.78]	.600 [15.24]	2	2-87631-4	2-87631-3	—
30	1.500 [38.10]	.700 [17.78]	.700 [17.78]	2	2-87631-6	2-87631-5	87733-6
32	1.600 [40.64]	.800 [20.32]	.700 [17.78]	2	2-87631-8	2-87631-7	87733-7
34	1.700 [43.18]	.800 [20.32]	.800 [20.32]	2	3-87631-0	2-87631-9	87733-8
36	1.800 [45.72]	.900 [22.86]	.800 [20.32]	2	3-87631-2	3-87631-1	—
38	1.900 [48.26]	.900 [22.86]	.900 [22.86]	2	—	3-87631-3	—
40	2.000 [50.80]	1.000 [25.40]	.900 [22.86]	2	3-87631-6	3-87631-5	1-87733-1
42	2.100 [53.34]	1.000 [25.40]	1.000 [25.40]	2	3-87631-8	3-87631-7	—
44	2.200 [55.88]	1.100 [27.94]	1.000 [25.40]	2	4-87631-0	3-87631-9	—
48	2.400 [60.96]	1.200 [30.48]	1.100 [27.94]	2	—	5-87631-9	—
50	2.500 [63.50]	1.200 [30.48]	1.200 [30.48]	2	4-87631-2	4-87631-1	1-87733-4
52	2.600 [66.04]	1.300 [33.02]	1.200 [30.48]	2	—	4-87631-3	—
54	2.700 [68.58]	1.300 [33.02]	1.300 [33.02]	2	4-87631-6	4-87631-5	—
58	2.900 [73.66]	1.400 [35.56]	1.400 [35.56]	2	—	6-87631-3	—
60	3.000 [76.20]	1.500 [38.10]	1.400 [35.56]	2	5-87631-2	5-87631-1	1-87733-7
64	3.200 [81.28]	1.600 [40.64]	1.500 [38.10]	2	6-87631-6	6-87631-5	—
66	3.300 [81.28]	1.600 [40.64]	1.600 [40.64]	2	—	5-87631-3	—
70	3.500 [88.90]	1.700 [43.18]	1.700 [43.18]	2	—	5-87631-5	—
72	3.800 [96.52]	1.800 [45.72]	1.700 [43.18]	2	5-87631-8	5-87631-7	—

*Cavity identification, AMP, part number and date code stamped on housing and/or strain relief where size permits.

**No marking on housing or strain relief.

- Notes:**
1. The Strain Relief/Pull Tab can be bonded to any thermoplastic connector housing.
 2. Strain reliefs may be purchased separately.
 3. Contact **Extraction/Lance Reset Tool No. 843996-3**.

Mod IV Wire-Applied Housings, Double-Row, .100 x .100 [2.54 x 2.54] Centerline (Continued)

Center Polarized



Material:

Black thermoplastic, flame retardant

Related Product Data:

Contacts—pages 228-230

Mateable Headers and Posts: Low Profile Shrouded Headers, Double-Row, Straight or Right-Angle Posts—pages 153-155

Low Profile Shrouded Headers, Double-Row, Straight or Right-Angle Posts, with .585 [14.86] Ejection Latches—pages 156-157

AMP-LATCH Ejection Headers with .576 [14.63] Ejection Latches—Catalog 82012, Part Nos. 102186-1 & 102320-1

Technical Documents (pages 294, 296):

Product Specification 108-25007, 208-25019, 108-25020, 108-25021

Application Specification 114-25003, 114-25016

Keying Plugs



Part No. 86286-1

(Plugs into standard or intermediate pressure receptacle contact)

Material—Natural color nylon



Part No. 87077-2

(Plugs directly into housing)

Position No. 1 Indicator

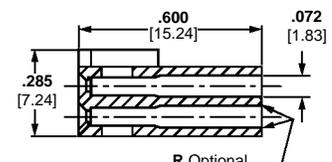
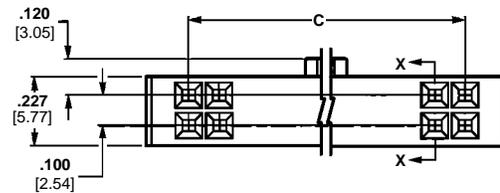
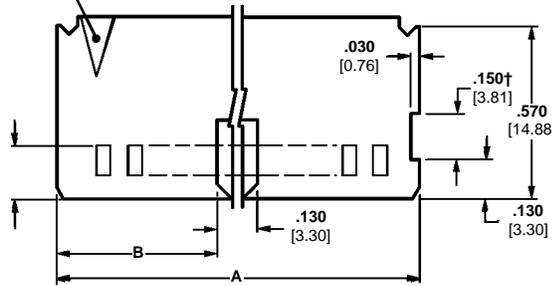

Section X-X

No. of Pos.	A	B	C	Part Nos. (Stamped*)
8	.580 [14.73]	.225 [5.72]	.300 [7.62]	1-102387-4
10	.680 [17.27]	.275 [6.98]	.400 [10.16]	102387-1
14	.880 [22.35]	.375 [9.53]	.600 [15.24]	102387-2
16	.980 [24.89]	.425 [10.80]	.700 [17.78]	102387-3
20	1.180 [29.97]	.525 [13.34]	.900 [22.86]	102387-4
22	1.280 [32.51]	.575 [14.61]	1.000 [25.40]	1-102387-5
24	1.380 [35.05]	.625 [15.88]	1.100 [27.94]	102387-5
26	1.480 [37.59]	.675 [17.15]	1.200 [30.48]	102387-6
30	1.680 [42.67]	.775 [19.69]	1.400 [35.56]	102387-7
34	1.880 [47.75]	.875 [22.23]	1.600 [40.64]	102387-8
40	2.180 [55.37]	1.025 [26.04]	1.900 [48.26]	102387-9
44	2.380 [60.45]	1.125 [28.58]	2.100 [53.34]	1-102387-3
50	2.680 [68.07]	1.275 [32.39]	2.400 [60.96]	1-102387-0
60	3.180 [80.77]	1.525 [38.74]	2.900 [73.66]	1-102387-1
64	3.380 [85.85]	1.625 [41.28]	3.100 [78.74]	1-102387-2

*Cavity identification and AMP stamped on housing.

†Non-functional slot is used for gating purposes during injection molding process. This gating feature is not inherent in all production molds. Therefore, the depicted slot will only be present on housings produced on mold tooling requiring this gating feature.

Note: Contact Extraction/Lance Reset Tool No. 843996-3.

Short Point, Crimp Snap-In Wire-Applied Contacts and Housings

Product Facts

- Short point of contact mates with .169 [4.29] to .259 [6.58] long post
- Double-row housings are end-to-end and side-to-side stackable
- Terminates 32-20 AWG [0.03-0.6 mm²] discrete wire
- Contacts have insulation support to accept a maximum insulation diameter of .060 [1.52]
- Available with .000015 [0.00038] or .000030 [0.00076] gold duplex, or bright tin-lead plating
- Mates with .025 [0.64] square posts
- Dual cantilever contact beams for reliable matings
- Locking retention latch provides 3 lb [13.34 N] of retention force
- Unique locking latch design helps prevent latch from protruding through latch window
- Contacts snap into AMPMODU MTE single-row housings
- Double-row housing configurations include .100 [2.54] centerline, plain and polarized
- Housing sizes range from 4 to 52 positions
- Recognized under the Component Program of Underwriters Laboratories Inc., File No. E28476
- Certified by Canadian Standards Association, File No. LR7189
- Produced under a Quality Management System certified to ISO 9001

A copy of the certificate is available upon request

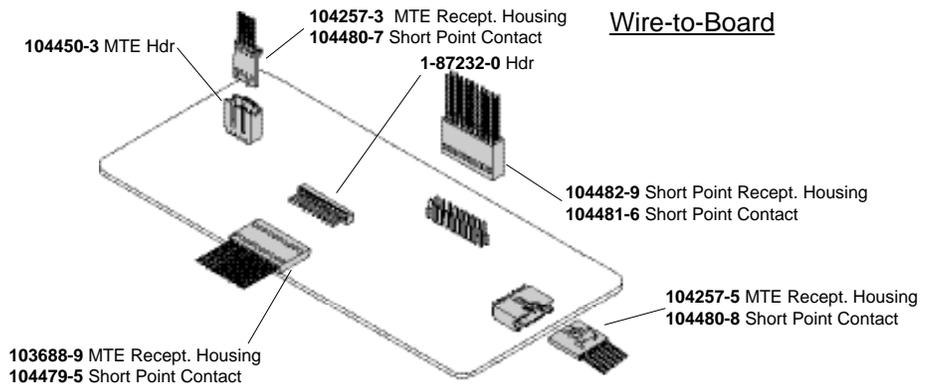
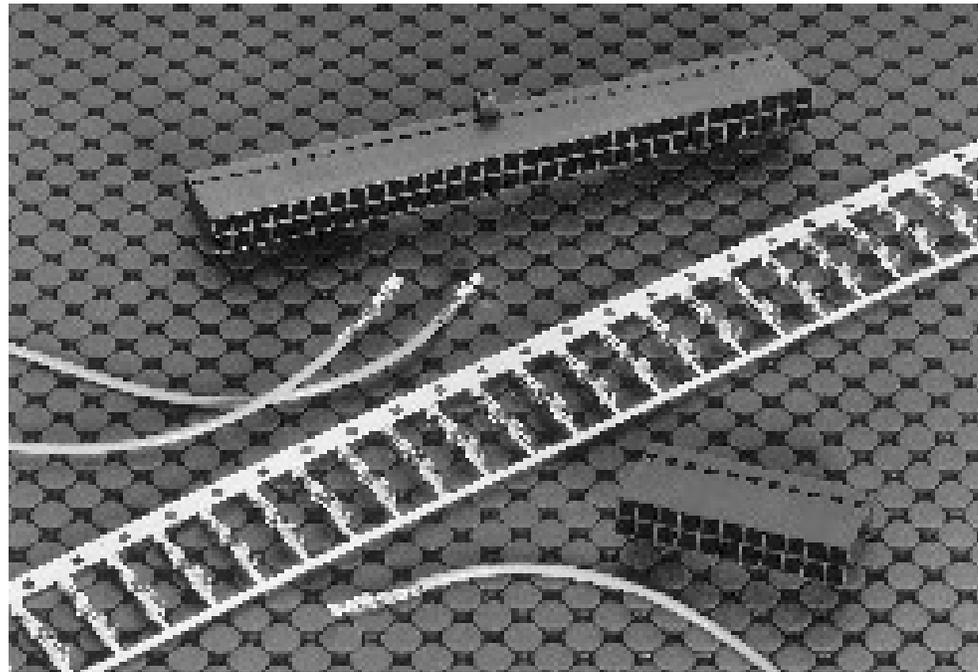

Wire-to-Board

AMPMODU Short Point receptacle contacts are designed to mate with .025 [0.64] square posts. They will mate with posts as short as .169 [4.29].

Short Point double-row housings are end-to-end and side-to-side stackable on .100 [2.54] centers. Contacts also can be used in single-row AMPMODU MTE housings to provide a complete wire-crimp system, or to serve as replacement contacts.

Performance Characteristics

- Contact Current Rating**—3 amperes
- Termination Resistance**—12 milliohms (max.)
- Durability**—Ref. Tyco Electronics Product Specification 108-1472

Short Point, Crimp Snap-In Wire-Applied Contacts and Housings

5

Short Point Crimp Snap-In Receptacle Contacts

Material and Finish:

Copper alloy C7025, plated as follows:

Plating A—Duplex plated .000030 [0.00076] min. gold on contact area, .000050 [0.00127] min. tin-lead in crimp area, with entire contact underplated .000050 [0.00127] min. nickel

Plating B—Duplex plated .000015 [0.00038] min. gold on contact area, .000050 [0.00127] min. tin-lead in crimp area, with entire contact underplated .000050 [0.00127] min. nickel

Plating C—.000100 [0.00254] min. bright tin-lead over .000050 [0.00127] min. nickel on entire contact

Related Product Data:

Performance Characteristics—page 238

Housings used in—Short Point—pages 240, 241

AMPMODU MTE Unloaded Housings—pages 245-250

Application Tooling—page 290

Technical Documents (page 294-296):

Product Specification 108-1472, 108-25027

Application Specification 114-25038

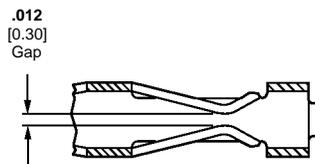
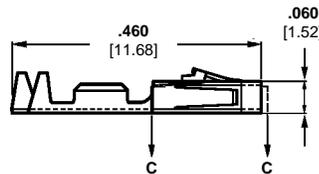
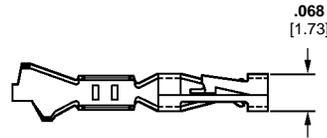

Section C - C



Keying Plug
Part No. 104072-1

Ten plugs are supplied per strip.
Order quantity reflects the number of strips required.



Photo 4857

Extraction/Lance Reset
Tool No. 843477-1

Wire Size Range	Ins. Dia. Range	Finish	Contact Part No. (Standard Pressure)		Quick-Change Applicator for AMP-O-LECTRIC Machine*	Applicator for AMP-O-MATIC Stripper/Crimper Machine	Hand Tool Nos.
			Strip Form	Loose Piece			
32-28 0.03-0.08	.025-.060 [0.64-1.52]	Plating A	104481-4	104481-8	567296-2	466980-1	91518-1
		Plating B	104481-3	104481-7			
		Plating C	104481-2	104481-6			
26-22 0.13-0.3	.025-.060 [0.64-1.52]	Plating A	104480-4	104480-9	567297-2	466981-1	91518-1
		Plating B	104480-3	104480-8			
		Plating C	104480-2	104480-7			
24-20 0.2-0.5	.025-.060 [0.64-1.52]	Plating A	104479-4	104479-7	567298-2	466982-1	91551-1
		Plating B	104479-3	104479-6			
		Plating C	104479-2	104479-5			

*For use with Model "K" machines. Call the Tooling/Technical Assistance Center (1-800-722-1111) for part nos. of applicators for use with the Model "G" machines (shown on page 289), as well as other bench machines and fully automatic AMPOMATOR lead making machines.

Short Point Wire-Applied Housings, Double-Row, Non-Polarized, .100 x .100 [2.54 x 2.54] Centerline



Material:

Black thermoplastic, flame retardant, 94V-0 rated

Related Product Data:

Performance Characteristics—page 238

Contacts—page 239

Mateable Headers—pages 105-108, 113, 114

Technical Documents (page 294-296):

Product Specification 108-1472, 108-25027

Application Specification 114-25038

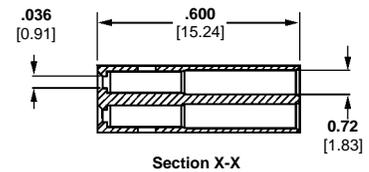
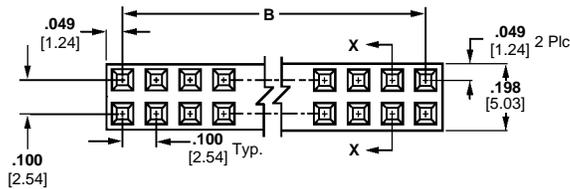
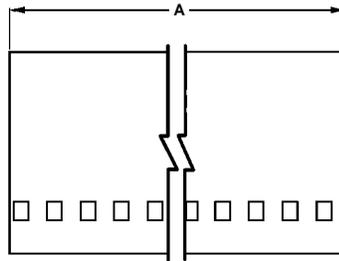

No. of Pos.	Dimensions		Housing Part No.
	A	B	
4	.198 [5.03]	.100 [2.54]	104482-1
6	.298 [7.57]	.200 [5.08]	104482-2
8	.398 [10.11]	.300 [7.62]	104482-3
10	.498 [12.65]	.400 [10.16]	104482-4
12	.598 [15.19]	.500 [12.70]	104482-5
14	.698 [17.73]	.600 [15.24]	104482-6
16	.798 [20.27]	.700 [17.78]	104482-7
18	.898 [22.81]	.800 [20.32]	104482-8
20	.998 [25.35]	.900 [22.86]	104482-9
22	1.098 [27.89]	1.000 [25.40]	1-104482-0
26	1.298 [32.97]	1.200 [30.48]	1-104482-1
28	1.398 [35.51]	1.300 [33.02]	1-104482-2
30	1.498 [38.05]	1.400 [35.56]	1-104482-3
32	1.598 [40.59]	1.500 [38.10]	1-104482-4
34	1.698 [43.13]	1.600 [40.64]	1-104482-5
36	1.798 [45.67]	1.700 [43.18]	1-104482-6
38	1.898 [48.21]	1.800 [45.72]	1-104482-7
40	1.998 [50.75]	1.900 [48.26]	1-104482-8
44	2.198 [55.83]	2.100 [53.34]	1-104482-9
52	2.598 [65.99]	2.500 [63.50]	2-104482-0

Short Point Wire-Applied Housings

5

Short Point Wire-Applied Housings, Double-Row, Polarized, .100 x .100 [2.54 x 2.54] Centerline

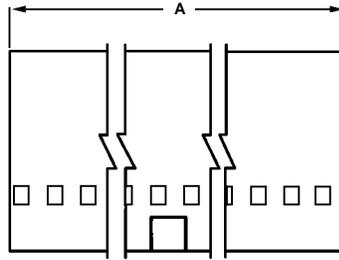
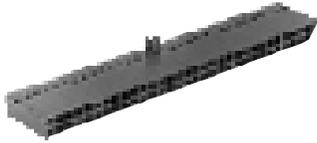

Material:

Black thermoplastic, flame retardant, 94V-0 rated

Related Product Data:

Performance Characteristics—page 238

Contacts—page 239

Mateable Headers—pages 121, 122, 153-155

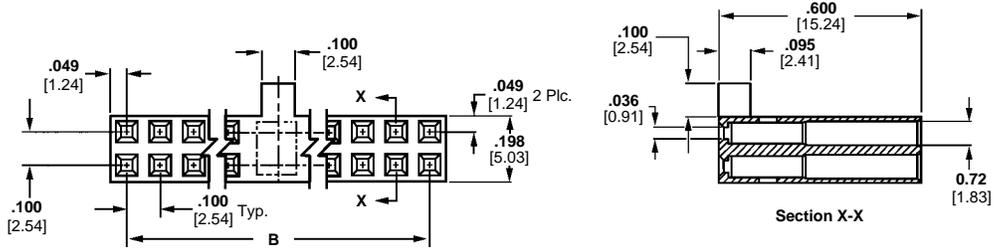

Technical Documents (page 294-296):

Product Specification 108-1472, 108-25027

Application Specification 114-25038

No. of Pos.	Dimensions		Housing Part No.
	A	B	
8	.398 [10.11]	.300 [7.62]	104483-1
10	.498 [12.65]	.400 [10.16]	1-104483-1
12	.598 [15.19]	.500 [12.70]	1-104483-2
14	.698 [17.73]	.600 [15.24]	104483-9
18	.898 [22.81]	.800 [20.32]	104483-2
20	.998 [25.35]	.900 [22.86]	104483-3
26	1.298 [32.97]	1.200 [30.48]	104483-4
30	1.498 [38.05]	1.400 [35.56]	104483-5
38	1.898 [48.21]	1.800 [45.72]	104483-6
50	2.498 [63.45]	2.400 [60.96]	1-104483-3
52	2.598 [65.99]	2.500 [63.50]	1-104483-0
54	2.698 [68.53]	2.600 [66.04]	104483-7
64	3.198 [81.23]	3.100 [78.74]	104483-8

Note: Other sizes can be made available on request.

MTE Interconnection System

Product Facts

- Receptacle assemblies mate with .025 [0.64] sq. posts; mating post length is .200 [5.08] min., .250 [6.35] max.
- Proven AMPMODU receptacle contact design; dual cantilever beams, built-in anti-overstress, completely enclosed "box" design, standard or high-pressure
- Insulation displacement technology
- Two contact sizes for terminating 30-22 AWG [0.05-0.3 mm²] wire range; .054 [1.37] max. insulation diameter with an insulation wall thickness of .015 [0.38] max.
- Choice of gold duplex or tin plated contacts
- Interchangeable crimp snap-in pin and receptacle contacts available
- Housing sizes 2 through 25 positions, single-row .100 [2.54] centers
- Colors also available
- Plain housings are end-to-end and/or back-to-back stackable for open pin field applications
- Optional header with "swaged tail" feature helps prevent movement prior to flow soldering
- Integral latch provides positive retention between header and receptacle housing
- Coupling shrouds permit ganging of smaller connectors with guide ribs to form larger single- or double-row latching connectors
- Mass terminating tooling provides lowest applied cost for most production needs
- SMT and SMT compatible, high-temp headers available
- Recognized under the Component Program of Underwriters Laboratories Inc., File No. E28476
- Certified by Canadian Standards Association, File No. LR7189

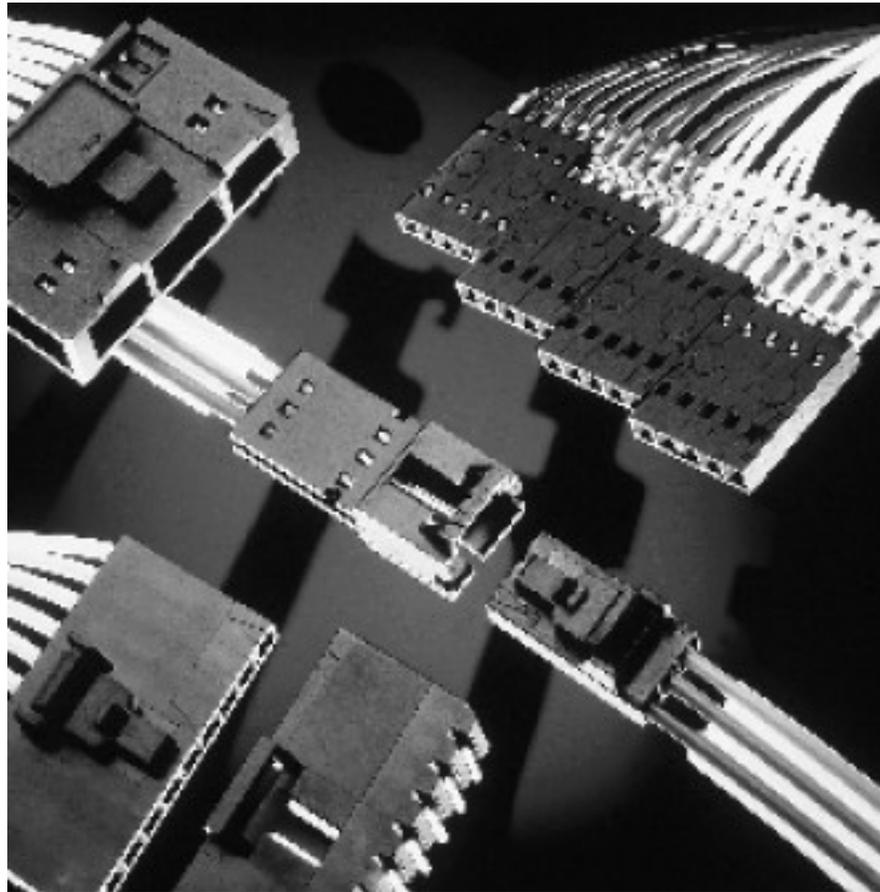

The AMPMODU MTE Interconnection System offers both wire-to-board and wire-to-wire connectors using .025 [0.64] sq. post technology.

The AMPMODU MTE Interconnection System consists of single-row housings with contacts preloaded on .100 [2.54] centers. Housings are furnished with contacts partially inserted, leaving the termination areas exposed. Final contact insertion is accomplished automatically by Tyco Electronics application equipment, and manually when terminated with the Tyco Electronics pistol grip hand tool.

The heart of the system is the insulation displacement contact design, featured in both pin and receptacle

contacts. The receptacle contact, available in either standard or high-pressure, features dual cantilever beams in an enclosed "box." The post stop helps prevent a mating post from disturbing the wire termination and also limits the mating depth of a long post to protect a wrap-type termination at the base of the post. The forward contact stop helps prevent contact overinsertion prior to termination. All contacts are furnished on carrier strips which are interlocked for stability and positive location during termination.

Single-row housings are available in sizes 2 through 25 positions. Included are three styles of receptacle housings—plain, polarized/latching and ribbed and two styles of pin housings, shrouded with polarizing/

Performance Specifications

Electrical Characteristics

Contact Current Rating—3 amperes for single contact in free air (Amperage could vary due to ambient temperature, wire size and duty cycles.)

Contact Termination Resistance—15 milliohms (max.)

Dielectric Withstanding Voltage—At Sea Level—600 VAC, rms
At 70,000 Ft. [21 336 m]—225 VAC, rms

Insulation Resistance—5,000 megohms (min.)

Environmental Characteristics

Operating Temperature—-65°C to +105°C

Vibration—15 G's (gold), 10 G's (tin)

Physical Shock—50 G's

Industrial Mixed Flow Gasing—Class 1 (20 days) (gold)

Product Specification
108-25034

Application Specification
114-25026

MTE Interconnection System (Continued)

Wire-to-Board

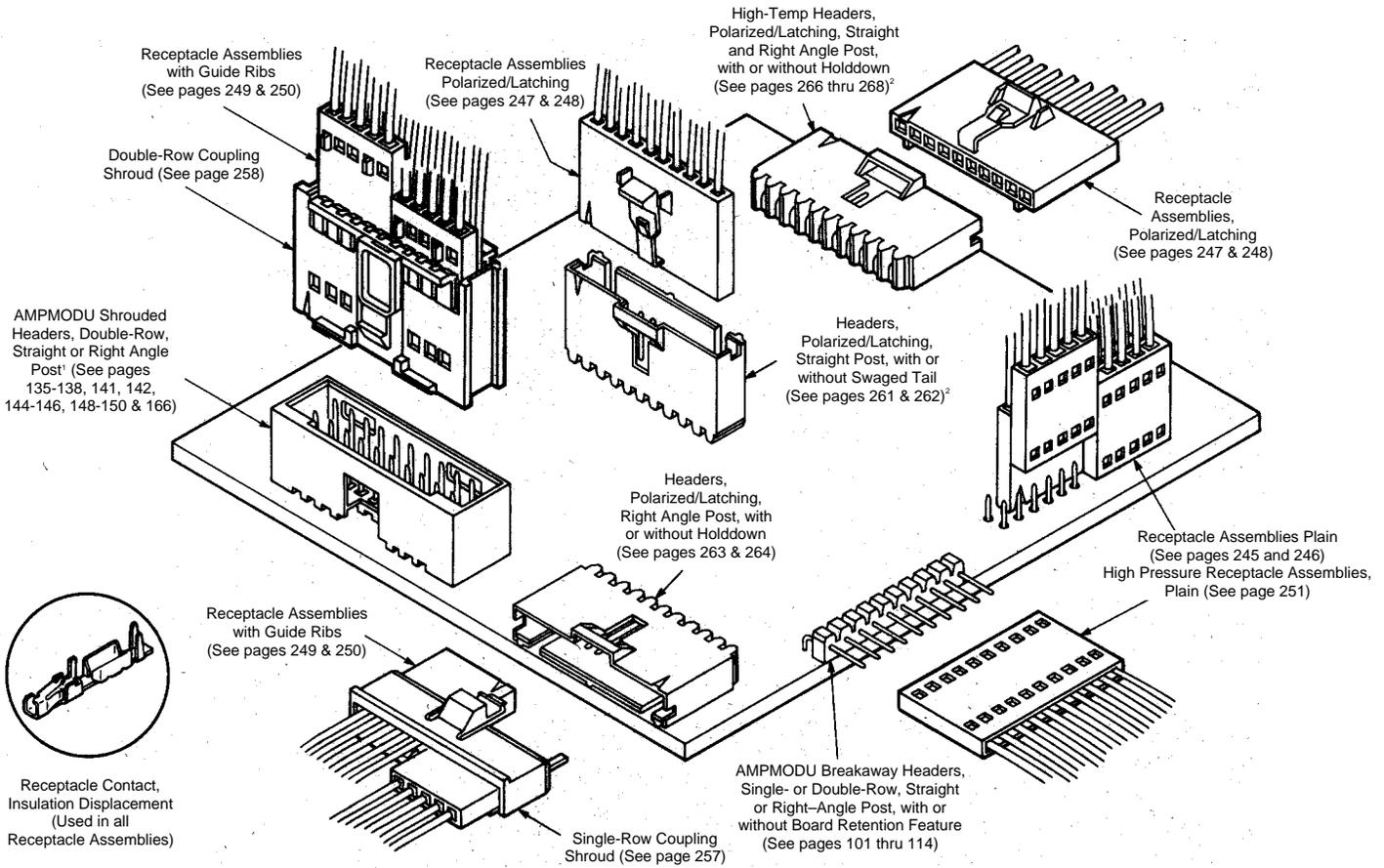

¹Mating AMPMODU Double-Row Shrouded Header Assemblies must have .318 [8.08] mating post length and .150 [3.81] dimension from centerline of last post to inside of end shroud wall.
 ²Surface Mount Right-Angle and Vertical Headers are also available (see pages 269 and 270)

Wire-to-Wire

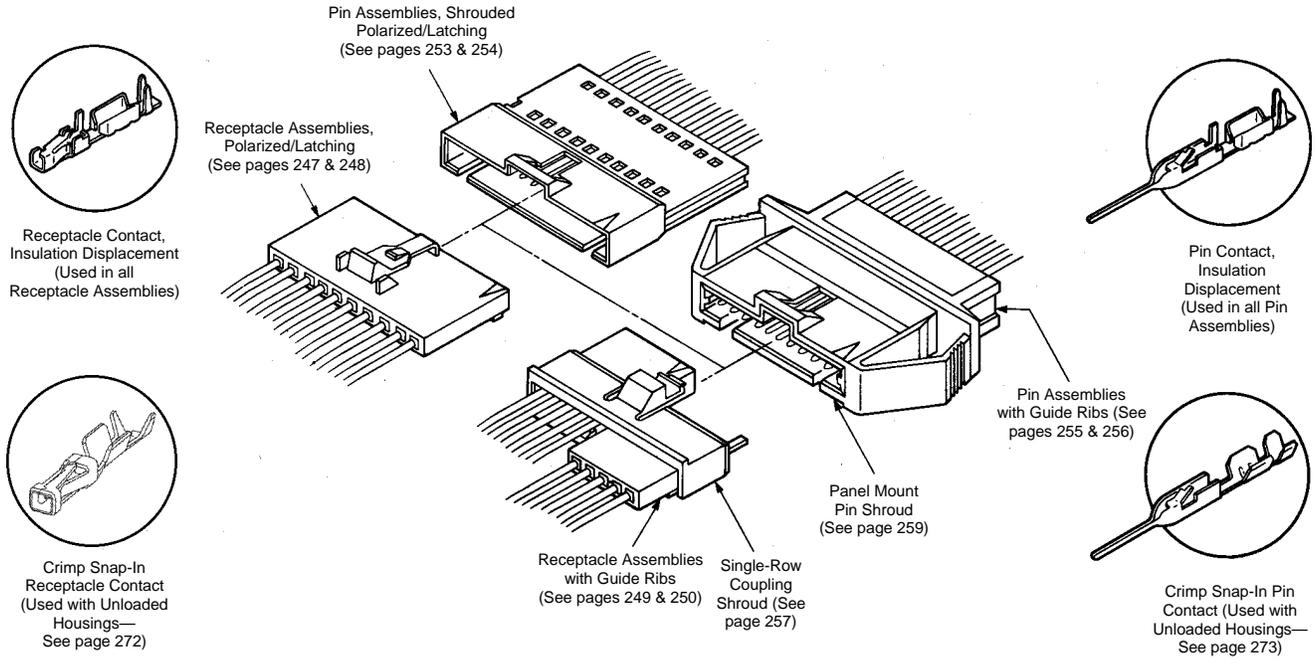

Note: For wire-to-wire applications shown above, all pin and receptacle assembly combinations are intermateable.

MTE Receptacle Assemblies—Plain, Single-Row, .100 [2.54] Centerline



Preassembled housings in strip form are available in positions 2 thru 12. For ease of handling, positions 2 thru 5 are recommended when using the Tyco Electronics Manual Pistol Grip Tool.

Material and Finish:

Housing—Black thermoplastic, 94V-0 rated

Contacts—Phosphor Bronze, plated as follows:

Plating A—Duplex plated .000030 [0.00076] gold on contact area, .000050 [0.00127] min. tin-lead in crimp area, with entire contact underplated .000050 [0.00127] nickel

Plating B—Duplex plated .000015 [0.00038] gold on contact area, .000050 [0.00127] min. tin-lead in crimp area, with entire contact underplated .000050 [0.00127] nickel

Plating C—.000100 [0.00254] bright tin-lead over .000050 [0.00127] nickel on entire contact

Note: Insulation displacement contacts accept an insulation diameter of .030 [0.76] min. to .054 [1.37] max. with an insulation wall thickness of .015 [0.38] max. Mating post length for preloaded housings is .200 [5.08] min., .250 [6.35] max.

Related Product Data:

Mateable AMPMODU Products:

Breakaway Headers—pages 101-114, 117-124 (with .230 mating length)

Reeled Breakaway Headers—pages 115-116 (with .230 mating length)

Machine Applied Bandolier Posts—page 180

Single- or Double-Row Shrouded Headers with .066 [1.68] End Dimension—pages 118, 121, 129-134, 139, 140, 143, 147, 149, 150, 162-165

Interchangeable Crimp Contacts (Short Point)—page 272

Application Tooling—pages 291, 292

Performance Specifications—page 242

Technical Documents (page 295, 296):

Product Specification 108-25034

Application Specification 114-25026

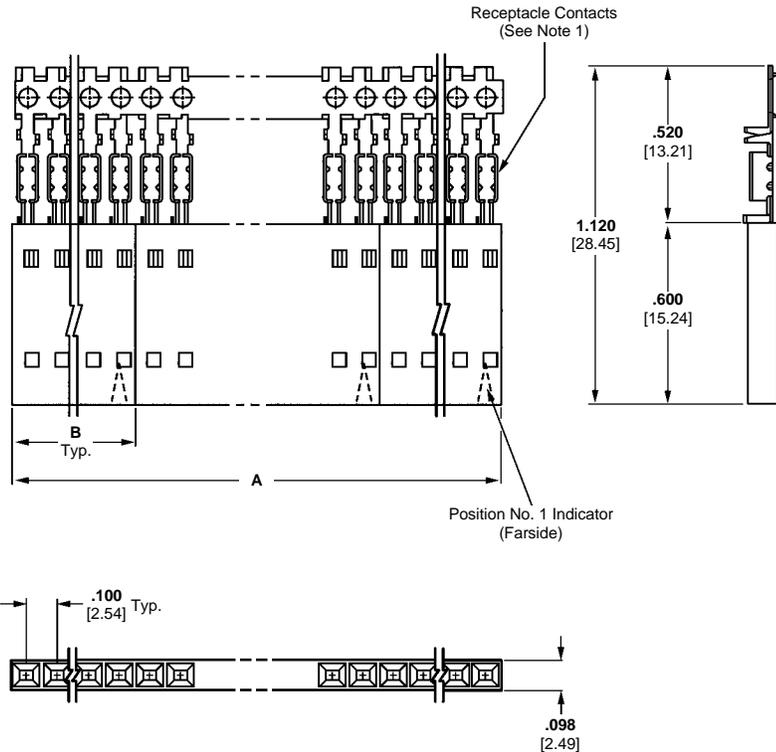

These receptacle assemblies with plain housings can be stacked end-to-end and/or side-to-side for single or double-row connections to an open pin field with a .100 [2.54] centerline grid.

**MTE Receptacle Assemblies—Strip Form Plain,
Single-Row, .100 [2.54] Centerline** (Continued)

No. of Pos.	Dimensions		Housing Quantities Per Strip Segment	Strip Form Receptacle Assembly 30-26 AWG [0.05-0.15mm ²] Wire			Strip Form Receptacle Assembly 26-22 AWG [0.12-0.3mm ²] Wire			Unloaded Housings
	A	B		Plating A	Plating B	Plating C	Plating A	Plating B	Plating C	
2	2.000 [50.80]	.198 [5.03]	10	103979-1	103978-1	103977-1	103976-1	103975-1	103974-1	103688-1
3	2.400 [60.96]	.298 [7.57]	8	103979-2	103978-2	103977-2	103976-2	103975-2	103974-2	103688-2
4	1.990 [50.55]	.398 [10.11]	5	103979-3	103978-3	103977-3	103976-3	103975-3	103974-3	103688-3
5	1.990 [50.55]	.498 [12.65]	4	103979-4	103978-4	103977-4	103976-4	103975-4	103974-4	103688-4
6	2.390 [60.71]	.598 [15.19]	4	103979-5	103978-5	103977-5	103976-5	103975-5	103974-5	103688-5
7	1.400 [35.56]	.698 [17.73]	2	103979-6	103978-6	103977-6	103976-6	103975-6	103974-6	103688-6
8	1.600 [40.64]	.798 [20.27]	2	103979-7	103978-7	103977-7	103976-7	103975-7	103974-7	103688-7
9	1.800 [45.72]	.898 [22.81]	2	103979-8	103978-8	103977-8	103976-8	103975-8	103974-8	103688-8
10	2.000 [50.80]	.998 [23.35]	2	103979-9	103978-9	103977-9	103976-9	103975-9	103974-9	103688-9
11	2.200 [55.88]	1.098 [27.89]	2	1-103979-0	1-103978-0	1-103977-0	1-103976-0	1-103975-0	1-103974-0	1-103688-0
12	2.400 [60.96]	1.198 [30.43]	2	1-103979-1	1-103978-1	1-103977-1	1-103976-1	1-103975-1	1-103974-1	1-103688-1

**MTE Receptacle Assemblies—Individual Form Plain,
Single-Row, .100 [2.54] Centerline**

No. of Pos.	Dimensions B	Individual Receptacle Assembly 30-26 AWG [0.05-0.15mm ²] Wire			Individual Receptacle Assembly 26-22 AWG [0.12-0.3mm ²] Wire			Unloaded Housings
		Plating A	Plating B	Plating C	Plating A	Plating B	Plating C	
13	1.298 [32.96]	1-103903-2	1-103684-2	1-103685-2	1-103902-2	1-103686-2	1-103687-2	1-103688-2
14	1.398 [35.51]	1-103903-3	1-103684-3	1-103685-3	1-103902-3	1-103686-3	1-103687-3	1-103688-3
15	1.498 [38.05]	1-103903-4	1-103684-4	1-103685-4	1-103902-4	1-103686-4	1-103687-4	1-103688-4
16	1.598 [40.59]	1-103903-5	1-103684-5	1-103685-5	1-103902-5	1-103686-5	1-103687-5	1-103688-5
17	1.698 [43.13]	1-103903-6	1-103684-6	1-103685-6	1-103902-6	1-103686-6	1-103687-6	1-103688-6
18	1.798 [45.67]	1-103903-7	1-103684-7	1-103685-7	1-103902-7	1-103686-7	1-103687-7	1-103688-7
19	1.898 [48.20]	1-103903-8	1-103684-8	1-103685-8	1-103902-8	1-103686-8	1-103687-8	1-103688-8
20	1.998 [50.75]	1-103903-9	1-103684-9	1-103685-9	1-103902-9	1-103686-9	1-103687-9	1-103688-9
21	2.098 [53.29]	2-103903-0	2-103684-0	2-103685-0	2-103902-0	2-103686-0	2-103687-0	2-103688-0
22	2.198 [55.83]	2-103903-1	2-103684-1	2-103685-1	2-103902-1	2-103686-1	2-103687-1	2-103688-1
23	2.298 [58.37]	2-103903-2	2-103684-2	2-103685-2	2-103902-2	2-103686-2	2-103687-2	2-103688-2
24	2.398 [60.91]	2-103903-3	2-103684-3	2-103685-3	2-103902-3	2-103686-3	2-103687-3	2-103688-3
25	2.498 [63.45]	2-103903-4	2-103684-4	2-103685-4	2-103902-4	2-103686-4	2-103687-4	2-103688-4

Notes: 1. Receptacle assemblies are furnished with strip contacts partially inserted into housing—contacts latched into “preload” windows. Contacts are fully inserted into housings automatically when terminated with Tyco Electronics application machines, or manually when terminated with AMP pistol grip hand tool.
 2. Use **Extraction/Lance Reset Tool No. 843477-1** to remove receptacle contacts.
 3. Keying plugs are available, see page 272.

MTE Receptacle Assemblies

5



Preassembled housings in strip form are available in positions 2 thru 12. For ease of handling, positions 2 thru 5 are recommended when using the Tyco Electronics Manual Pistol Grip Tool.

Material and Finish:

Housing—Black thermoplastic, 94V-0 rated

Contacts—Phosphor Bronze, plated as follows:

Plating A—Duplex plated .000030 [0.00076] gold on contact area, .000050 [0.00127] min. tin-lead in crimp area, with entire contact underplated .000050 [0.00127] nickel

Plating B—Duplex plated .000015 [0.00038] gold on contact area, .000050 [0.00127] min. tin-lead in crimp area, with entire contact underplated .000050 [0.00127] nickel

Plating C—.000100 [0.00254] bright tin-lead over .000050 [0.00127] nickel on entire contact

Note: Insulation displacement contacts accept an insulation diameter of .030 [0.76] min. to .054 [1.37] max. with an insulation wall thickness of .015 [0.38] max. Mating post length for preloaded housings is .200 [5.08] min., .250 [6.35] max.

Related Product Data:

Mateable AMPMODU Products:

Pin Assemblies

(Polarized/Latching)—pages 253, 254

Pin Assemblies with Guide

Ribs (installed in Panel Mount Pin Shroud)—pages 255, 256, 259

Headers (Polarized/Latching)—pages 261-270

Interchangeable Crimp Contacts

(Short Point)—page 272

Application Tooling—pages 291, 292

Performance Specifications—page 242

Technical Documents (pages 295, 296):

Product Specification

108-25034

Application Specification

114-25026

MTE Receptacle Assemblies—Polarized/Latching, Single-Row, .100 [2.54] Centerline

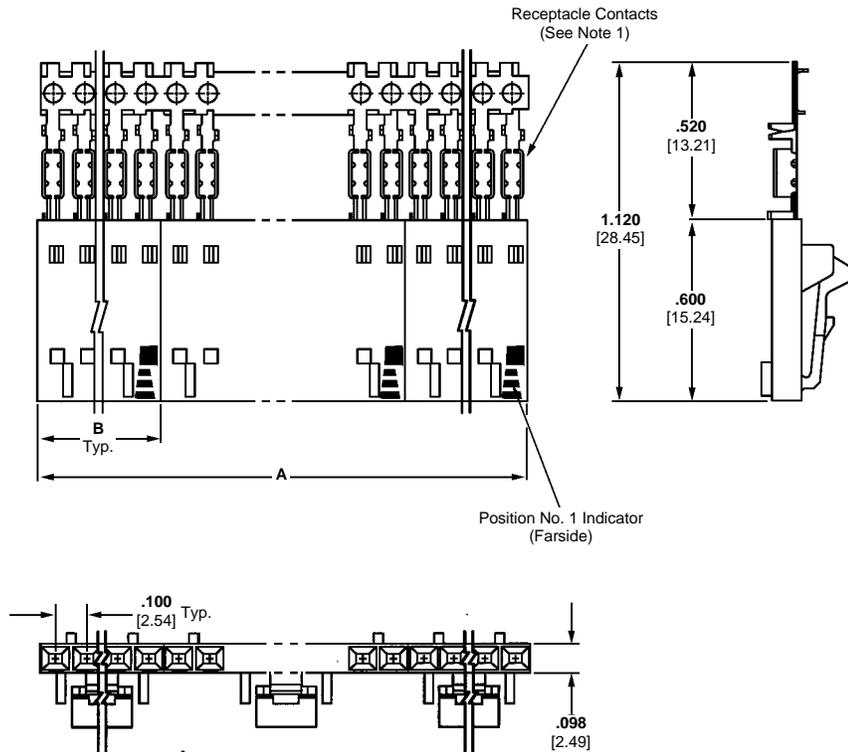

MTE Receptacle Assemblies—Strip Form Polarized/Latching, Single-Row, .100 [2.54] Centerline (Continued)

No. of Pos.	Dimensions		Housing Quantities Per Strip Segment	Strip Form Receptacle Assembly 30-26 AWG [0.05-0.15mm ²] Wire			Strip Form Receptacle Assembly 26-22 AWG [0.12-0.3mm ²] Wire			Unloaded Housings
	A	B		Plating A	Plating B	Plating C	Plating A	Plating B	Plating C	
2	2.000 [50.80]	.198 [5.03]	10	103961-1	103960-1	103959-1	103958-1	103957-1	103956-1	104257-1
3	2.400 [60.96]	.298 [7.57]	8	103961-2	103960-2	103959-2	103958-2	103957-2	103956-2	104257-2
4	1.990 [50.55]	.398 [10.11]	5	103961-3	103960-3	103959-3	103958-3	103957-3	103956-3	104257-3
5	1.990 [50.55]	.498 [12.65]	4	103961-4	103960-4	103959-4	103958-4	103957-4	103956-4	104257-4
6	2.390 [60.71]	.598 [15.19]	4	103961-5	103960-5	103959-5	103958-5	103957-5	103956-5	104257-5
7	1.400 [35.56]	.698 [17.73]	2	103961-6	103960-6	103959-6	103958-6	103957-6	103956-6	104257-6
8	1.600 [40.64]	.798 [20.27]	2	103961-7	103960-7	103959-7	103958-7	103957-7	103956-7	104257-7
9	1.800 [45.72]	.898 [22.81]	2	103961-8	103960-8	103959-8	103958-8	103957-8	103956-8	104257-8
10	2.000 [50.80]	.998 [23.35]	2	103961-9	103960-9	103959-9	103958-9	103957-9	103956-9	104257-9
11	2.200 [55.88]	1.098 [27.89]	2	1-103961-0	1-103960-0	1-103959-0	1-103958-0	1-103957-0	1-103956-0	1-104257-0
12	2.400 [60.96]	1.198 [30.43]	2	1-103961-1	1-103960-1	1-103959-1	1-103958-1	1-103957-1	1-103956-1	1-104257-1

MTE Receptacle Assemblies—Individual Form Polarized/Latching, Single-Row, .100 [2.54] Centerline

No. of Pos.	Dimensions B	Individual Receptacle Assembly 30-26 AWG [0.05-0.15mm ²] Wire			Individual Receptacle Assembly 26-22 AWG [0.12-0.3mm ²] Wire			Unloaded Housings
		Plating A	Plating B	Plating C	Plating A	Plating B	Plating C	
13	1.298 [32.96]	1-103897-2	1-103640-2	1-103641-2	1-103734-2	1-103644-2	1-103645-2	1-104257-2
14	1.398 [35.51]	1-103897-3	1-103640-3	1-103641-3	1-103734-3	1-103644-3	1-103645-3	1-104257-3
15	1.498 [38.05]	1-103897-4	1-103640-4	1-103641-4	1-103734-4	1-103644-4	1-103645-4	1-104257-4
16	1.598 [40.59]	1-103897-5	1-103640-5	1-103641-5	1-103734-5	1-103644-5	1-103645-5	1-104257-5
17	1.698 [43.13]	1-103897-6	1-103640-6	1-103641-6	1-103734-6	1-103644-6	1-103645-6	1-104257-6
18	1.798 [45.67]	1-103897-7	1-103640-7	1-103641-7	1-103734-7	1-103644-7	1-103645-7	1-104257-7
19	1.898 [48.20]	1-103897-8	1-103640-8	1-103641-8	1-103734-8	1-103644-8	1-103645-8	1-104257-8
20	1.998 [50.75]	1-103897-9	1-103640-9	1-103641-9	1-103734-9	1-103644-9	1-103645-9	1-104257-9
21	2.098 [53.29]	2-103897-0	2-103640-0	2-103641-0	2-103734-0	2-103644-0	2-103645-0	2-104257-0
22	2.198 [55.83]	2-103897-1	2-103640-1	2-103641-1	2-103734-1	2-103644-1	2-103645-1	2-104257-1
23	2.298 [58.37]	2-103897-2	2-103640-2	2-103641-2	2-103734-2	2-103644-2	2-103645-2	2-104257-2
24	2.398 [60.91]	2-103897-3	2-103640-3	2-103641-3	2-103734-3	2-103644-3	2-103645-3	2-104257-3
25	2.498 [63.45]	2-103897-4	2-103640-4	2-103641-4	2-103734-4	2-103644-4	2-103645-4	2-104257-4

Notes: 1. Receptacle assemblies are furnished with strip contacts partially inserted into housing—contacts latched into “preload” windows. Contacts are fully inserted into housings automatically when terminated with AMP application machines, or manually when terminated with AMP pistol grip hand tool.
 2. Use **Extraction/Lance Reset Tool No. 843477-1** to remove receptacle contacts.
 3. Keying plugs are available, see page 272.

MTE Receptacle Assemblies

5



Preassembled housings in strip form are available in positions 2 thru 12. For ease of handling, positions 2 thru 5 are recommended when using the Tyco Electronics Manual Pistol Grip Tool.

Material and Finish:

Housing—Black thermoplastic, 94V-0 rated

Contacts—Phosphor Bronze, plated as follows:

Plating A—Duplex plated .000030 [0.00076] gold on contact area, .000050 [0.00127] min. tin-lead in crimp area, with entire contact underplated .000050 [0.00127] nickel

Plating B—Duplex plated .000015 [0.00038] gold on contact area, .000050 [0.00127] min. tin-lead in crimp area, with entire contact underplated .000050 [0.00127] nickel

Plating C—.000100 [0.00254] bright tin-lead over .000050 [0.00127] nickel on entire contact

Note: Insulation displacement contacts accept an insulation diameter of .030 [0.76] min. to .054 [1.37] max. with an insulation wall thickness of .015 [0.38] max. Mating post length for preloaded housings is .200 [5.08] min., .250 [6.35] max.

Related Product Data:

Coupling Shrouds used with:

Single-Row—page 257

Double-Row—page 258

Mateable AMPMODU Products (with Receptacle Assemblies Installed in Single-Row Coupling Shrouds):

Pin Assemblies (Polarized/Latching)—pages 253, 254

Pin Assemblies with Guide Ribs (installed in Panel Mount Pin Shroud)—pages 255, 256, 259

Headers (Polarized/Latching)—pages 261-270

Mateable AMPMODU Products (with Receptacle Assemblies Installed in Double-Row Coupling Shrouds):

Headers, Shrouded, Double-Row (.318 [8.08] mating post length, .150 [3.81] end dimension)—pages 135-138, 141, 142, 144, 145, 146, 148-150, 166

Interchangeable Crimp Contacts—(Short Point)—page 272

Application Tooling—pages 291, 292

Performance Specifications—page 242

MTE Receptacle Assemblies—Guide Ribs, Single-Row, .100 [2.54] Centerline

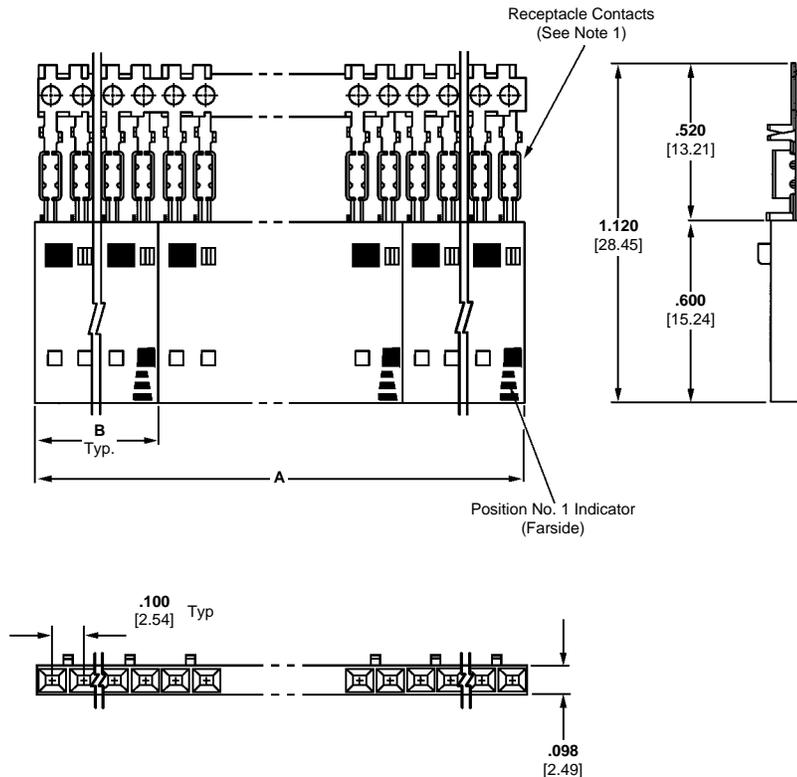

Technical Documents (pages 295, 296):

Product Specification
108-25034

Application Specification
114-25026

**MTE Receptacle Assemblies—Strip Form with Guide Ribs,
Single-Row, .100 [2.54] Centerline** (Continued)

No. of Pos.	Dimensions		Housing Quantities Per Strip Segment	Strip Form Receptacle Assembly 30-26 AWG [0.05-0.15mm ²] Wire			Strip Form Receptacle Assembly 26-22 AWG [0.12-0.3mm ²] Wire			Unloaded Housings
	A	B		Plating A	Plating B	Plating C	Plating A	Plating B	Plating C	
2	2.000 [50.80]	.198 [5.03]	10	103973-1	103972-1	103971-1	103970-1	103969-1	103968-1	103648-1
3	2.400 [60.96]	.298 [7.57]	8	103973-2	103972-2	103971-2	103970-2	103969-2	103968-2	103648-2
4	1.990 [50.55]	.398 [10.11]	5	103973-3	103972-3	103971-3	103970-3	103969-3	103968-3	103648-3
5	1.990 [50.55]	.498 [12.65]	4	103973-4	103972-4	103971-4	103970-4	103969-4	103968-4	103648-4
6	2.390 [60.71]	.598 [15.19]	4	103973-5	103972-5	103971-5	103970-5	103969-5	103968-5	103648-5
7	1.400 [35.56]	.698 [17.73]	2	103973-6	103972-6	103971-6	103970-6	103969-6	103968-6	103648-6
8	1.600 [40.64]	.798 [20.27]	2	103973-7	103972-7	103971-7	103970-7	103969-7	103968-7	103648-7
9	1.800 [45.72]	.898 [22.81]	2	103973-8	103972-8	103971-8	103970-8	103969-8	103968-8	103648-8
10	2.000 [50.80]	.998 [23.35]	2	103973-9	103972-9	103971-9	103970-9	103969-9	103968-9	103648-9
11	2.200 [55.88]	1.098 [27.89]	2	1-103973-0	1-103972-0	1-103971-0	1-103970-0	1-103969-0	1-103968-0	1-103648-0
12	2.400 [60.96]	1.198 [30.43]	2	1-103973-1	1-103972-1	1-103971-1	1-103970-1	1-103969-1	1-103968-1	1-103648-1

**MTE Receptacle Assemblies—Individual Form with Guide Ribs,
Single-Row, .100 [2.54] Centerline**

No. of Pos.	Dimensions B	Individual Receptacle Assembly 30-26 AWG [0.05-0.15mm ²] Wire			Individual Receptacle Assembly 26-22 AWG [0.12-0.3mm ²] Wire			Unloaded Housings
		Plating A	Plating B	Plating C	Plating A	Plating B	Plating C	
13	1.298 [32.96]	1-103901-2	1-103649-2	1-103650-2	1-103900-2	1-103651-2	1-103652-2	1-103648-2
14	1.398 [35.51]	1-103901-3	1-103649-3	1-103650-3	1-103900-3	1-103651-3	1-103652-3	1-103648-3
15	1.498 [38.05]	1-103901-4	1-103649-4	1-103650-4	1-103900-4	1-103651-4	1-103652-4	1-103648-4
16	1.598 [40.59]	1-103901-5	1-103649-5	1-103650-5	1-103900-5	1-103651-5	1-103652-5	1-103648-5
17	1.698 [43.13]	1-103901-6	1-103649-6	1-103650-6	1-103900-6	1-103651-6	1-103652-6	1-103648-6
18	1.798 [45.67]	1-103901-7	1-103649-7	1-103650-7	1-103900-7	1-103651-7	1-103652-7	1-103648-7
19	1.898 [48.20]	1-103901-8	1-103649-8	1-103650-8	1-103900-8	1-103651-8	1-103652-8	1-103648-8
20	1.998 [50.75]	1-103901-9	1-103649-9	1-103650-9	1-103900-9	1-103651-9	1-103652-9	1-103648-9
21	2.098 [53.29]	2-103901-0	2-103649-0	2-103650-0	2-103900-0	2-103651-0	2-103652-0	2-103648-0
22	2.198 [55.83]	2-103901-1	2-103649-1	2-103650-1	2-103900-1	2-103651-1	2-103652-1	2-103648-1
23	2.298 [58.37]	2-103901-2	2-103649-2	2-103650-2	2-103900-2	2-103651-2	2-103652-2	2-103648-2
24	2.398 [60.91]	2-103901-3	2-103649-3	2-103650-3	2-103900-3	2-103651-3	2-103652-3	2-103648-3
25	2.498 [63.45]	2-103901-4	2-103649-4	2-103650-4	2-103900-4	2-103651-4	2-103652-4	2-103648-4

- Notes:** 1. Receptacle assemblies are furnished with strip contacts partially inserted into housing—contacts latched into "preload" windows. Contacts are fully inserted into housings automatically when terminated with AMP application machines, or manually when terminated with AMP pistol grip hand tool.
 2. Use **Extraction/Lance Reset Tool No. 843477-1** to remove receptacle contacts.
 3. Keying plugs are available, see page 272.

MTE Receptacle Assemblies

5

MTE High Pressure Receptacle Assemblies—Plain, Single-Row, .100 [2.54] Centerline



Preassembled housings in strip form are available in positions 2 thru 12. For ease of handling, positions 2 thru 5 are recommended when using the Tyco Electronics Manual Pistol Grip Tool.

Material and Finish:

Housing—Black thermoplastic, 94V-0 rated

Contacts—Phosphor Bronze, duplex plated .000030 [0.00076] gold on contact area, .000050 [0.00127] min. tin-lead in crimp area, with entire contact underplated .000050 [0.00127] nickel

Note: Insulation displacement contacts accept an insulation diameter of .030 [0.76] min. to .054 [1.37] max. with an insulation wall thickness of .015 [0.38] max. Mating post length for preloaded housings is .200 [5.08] min., .250 [6.35] max.

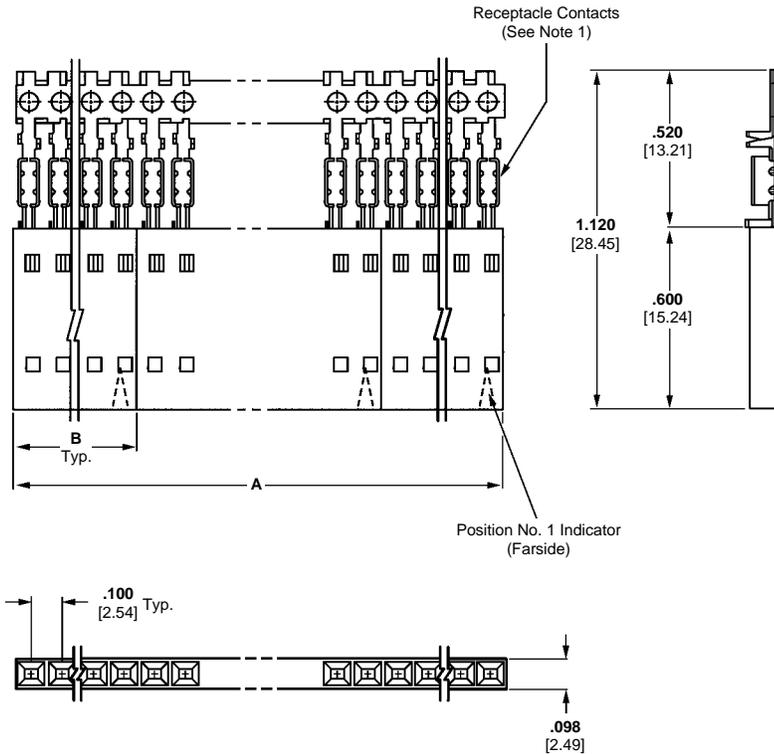

Related Product Data:

Mateable AMPMODU Products:

Breakaway Headers—pages 101-114, 117-124 (with .230 mating length)

Reeled Breakaway Headers—pages 115-116 (with .230 mating length)

Machine Applied Bandolier Posts—page 180

Application Tooling—pages 291, 292

Performance Specifications—page 242

Technical Documents (pages 295, 296):

Product Specification 108-25034

Application Specification 114-25026

No. of Pos	Dimensions		Housings Quantities Per Strip Segment	Strip Form Receptacle Assembly 30-26 AWG	Strip Form Receptacle Assembly 26-22 AWG
	A	B		[.05-.15mm] Wire	[.12-.30mm] Wire
2	1.980 [50.29]	.198 [5.03]	10	104438-1	104439-1
3	1.490 [37.85]	.298 [7.57]	5	104438-2	104439-2
4	1.990 [50.55]	.398 [10.11]	5	104438-3	104439-3
5	1.990 [50.55]	.498 [12.65]	4	104438-4	104439-4
6	2.390 [60.71]	.598 [15.19]	4	104438-5	104439-5
7	1.400 [35.56]	.698 [17.73]	2	104438-6	104439-6
8	1.600 [40.64]	.798 [20.27]	2	104438-7	104439-7
9	1.800 [45.72]	.898 [22.81]	2	104438-8	104439-8
10	2.000 [50.80]	.998 [23.35]	2	104438-9	104439-9
11	2.200 [55.88]	1.098 [27.89]	2	1-104438-0	1-104439-0
12	2.400 [60.96]	1.198 [30.43]	2	1-104438-1	1-104439-1

- Notes:**
1. Receptacle assemblies are furnished with strip contacts partially inserted into housing—contacts latched into "preload" windows. Contacts are fully inserted into housings automatically when terminated with AMP application machines, or manually when terminated with AMP pistol grip hand tool.
 2. High pressure receptacle contacts can be made available in other housing styles and position sizes. Contact your Tyco Electronics sales representative.

MTE High Pressure Receptacle Assemblies – Guide Ribs



Photo 5527

Preassembled housings in strip form are available in positions 2 thru 12. For ease of handling, positions 2 thru 5 are recommended when using the Tyco Electronics Manual Pistol Grip Tool.

Material and Finish:

Housing—Thermoplastic, Color-Black, 94V-0 rated

Contacts—Phosphor Bronze, Duplex plated .000030 [0.00076] gold on contact area .000100 [0.00254] min. tin-lead on crimp area, with entire post under-plated .000050 [0.00127] nickel.

Related Product Data:

Coupling Shrouds used with:

Single-Row—page 257

Double-Row—page 258

Mateable AMPMODU Products (with Receptacle Assemblies Installed in Single-Row Coupling Shrouds):

Pin Assemblies (Polarized/Latching)—pages 253, 254

Pin Assemblies with Guide Ribs (installed in Panel Mount Pin Shroud)—pages 255, 256, 259

Headers (Polarized/Latching)—pages 261-270

Mateable AMPMODU Products (with Receptacle Assemblies Installed in Double-Row Coupling Shrouds):

Headers, Shrouded, Double-Row (.318 [8.08] mating post length, .150 [3.81] end dimension)—pages 135, 137, 141, 145, 146, 148-150, 166

Application Tooling—pages 291, 292

Performance Specifications—page 242

Technical Documents (pages 295, 296):

Product Specification 108-25034

Application Specification 114-25026

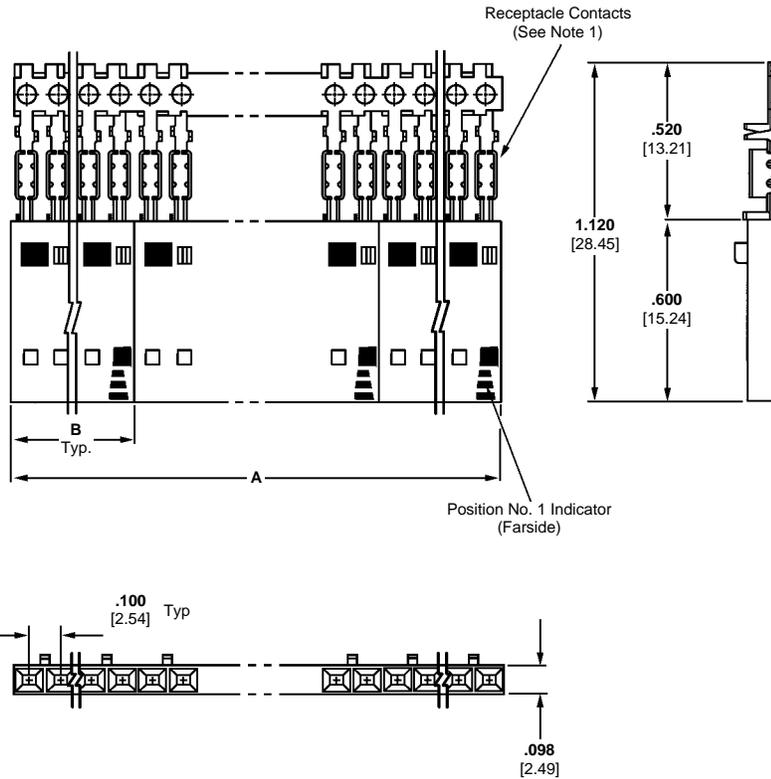

No. of Pos	Dimensions		Housings Quantities Per Strip Segment	Strip Form Receptacle Assembly 30-26 AWG [.05-.15mm ²] Wire	Strip Form Receptacle Assembly 26-22 AWG [.12-.30mm ²] Wire
	A	B			
2	1.980 [50.29]	.198 [5.03]	10	147396-1	147030-3
3	1.490 [37.85]	.298 [7.57]	5	147396-2	147030-4
4	1.990 [50.55]	.398 [10.11]	5	147396-3	147030-1
5	1.990 [50.55]	.498 [12.65]	4	147396-4	147030-2
6	2.390 [60.71]	.598 [15.19]	4	147396-5	147030-5
7	1.400 [35.56]	.698 [17.73]	2	147396-6	147030-6
8	1.600 [40.64]	.798 [20.27]	2	147396-7	147030-7
9	1.800 [45.72]	.898 [22.81]	2	147396-8	147030-8
10	2.000 [50.80]	.998 [23.35]	2	147396-9	147030-9
11	2.200 [55.88]	1.098 [27.89]	2	1-147396-0	1-147030-0
12	2.400 [60.96]	1.198 [30.43]	2	1-147396-1	1-147030-1

MTE Pin Assemblies

5

**MTE Pin Assemblies, Shrouded—Polarized/Latching,
Single-Row, .100 [2.54] Centerline**



Preassembled housings in strip form are available in positions 2 thru 12. For ease of handling, positions 2 thru 5 are recommended when using the Tyco Electronics Manual Pistol Grip Tool.

Material and Finish:

Housing—Black thermoplastic, 94V-0 rated

Contacts—Phosphor Bronze, plated as follows:

Plating A—Duplex plated .000030 [0.00076] gold on contact area, .000050 [0.00127] min. tin-lead in crimp area, with entire contact underplated .000050 [0.00127] nickel

Plating B—Duplex plated .000015 [0.00038] gold on contact area, .000050 [0.00127] min. tin-lead in crimp area, with entire contact underplated .000050 [0.00127] nickel

Plating C—.000100 [0.00254] bright tin-lead over .000050 [0.00127] nickel on entire contact

Note: Insulation displacement contacts accept an insulation diameter of .030 [0.76] min. to .054 [1.37] max. with an insulation wall thickness of .015 [0.38] max.

Related Product Data:

Mateable AMPMODU Products:

Receptacle Assemblies (Polarized/Latching)—pages 247, 248

Receptacle Assemblies with Guide Ribs (installed in Single-Row Coupling Shroud)—pages 249, 250, 252, 257

Interchangeable Crimp Contacts—page 273

Application Tooling—pages 291, 292

Performance Specifications—page 242

Technical Documents (pages 295, 296):

Product Specification
108-25034

Application Specification
114-25026

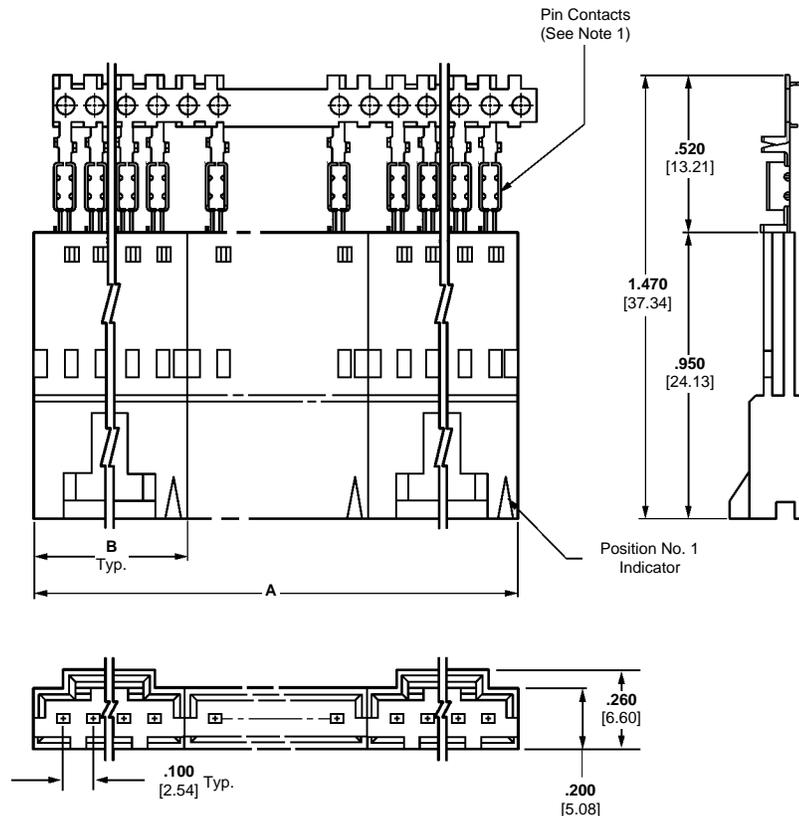

MTE Pin Assemblies, Shrouded—Strip Form Polarized/Latching, Single-Row, .100 [2.54] Centerline (Continued)

No. of Pos.	Dimensions		Housing Quantities Per Strip Segment	Strip Form Pin Assembly 30-26 AWG [0.05-0.15mm ²] Wire			Strip Form Pin Assembly 26-22 AWG [0.12-0.3mm ²] Wire			Unloaded Housings
	A	B		Plating A	Plating B	Plating C	Plating A	Plating B	Plating C	
2	2.360 [59.94]	.295 [7.49]	8	103949-1	103948-1	103947-1	103946-1	103945-1	103944-1	103653-1
3	1.980 [50.29]	.395 [10.03]	5	103949-2	103948-2	103947-2	103946-2	103945-2	103944-2	103653-2
4	1.980 [50.29]	.495 [12.57]	4	103949-3	103948-3	103947-3	103946-3	103945-3	103944-3	103653-3
5	2.380 [60.45]	.595 [15.11]	4	103949-4	103948-4	103947-4	103946-4	103945-4	103944-4	103653-4
6	1.390 [35.31]	.695 [17.65]	2	103949-5	103948-5	103947-5	103946-5	103945-5	103944-5	103653-5
7	2.390 [60.71]	.795 [20.19]	3	103949-6	103948-6	103947-6	103946-6	103945-6	103944-6	103653-6
8	1.790 [45.47]	.895 [22.73]	2	103949-7	103948-7	103947-7	103946-7	103945-7	103944-7	103653-7
9	1.990 [50.57]	.995 [25.27]	2	103949-8	103948-8	103947-8	103946-8	103945-8	103944-8	103653-8
10	2.190 [55.63]	1.095 [27.81]	2	103949-9	103948-9	103947-9	103946-9	103945-9	103944-9	103653-9
11	2.390 [60.71]	1.195 [30.35]	2	1-103949-0	1-103948-0	1-103947-0	1-103946-0	1-103945-0	1-103944-0	1-103653-0
12	2.590 [65.79]	1.295 [32.89]	2	1-103949-1	1-103948-1	1-103947-1	1-103946-1	1-103945-1	1-103944-1	1-103653-1

MTE Pin Assemblies, Shrouded—Individual Form Polarized/Latching, Single-Row, .100 [2.54] Centerline

No. of Pos.	Dimensions B	Individual Pin Assembly 30-26 AWG [0.05-0.15mm ²] Wire			Individual Pin Assembly 26-22 AWG [0.12-0.3mm ²] Wire			Unloaded Housings
		Plating A	Plating B	Plating C	Plating A	Plating B	Plating C	
13	1.395 [35.43]	1-103894-2	1-103658-2	1-103659-2	1-103893-2	1-103660-2	1-103661-2	1-103653-2
14	1.495 [37.97]	1-103894-3	1-103658-3	1-103659-3	1-103893-3	1-103660-3	1-103661-3	1-103653-3
15	1.595 [40.51]	1-103894-4	1-103658-4	1-103659-4	1-103893-4	1-103660-4	1-103661-4	1-103653-4
16	1.695 [43.05]	1-103894-5	1-103658-5	1-103659-5	1-103893-5	1-103660-5	1-103661-5	1-103653-5
17	1.795 [45.59]	1-103894-6	1-103658-6	1-103659-6	1-103893-6	1-103660-6	1-103661-6	1-103653-6
18	1.895 [48.13]	1-103894-7	1-103658-7	1-103659-7	1-103893-7	1-103660-7	1-103661-7	1-103653-7
19	1.995 [50.67]	1-103894-8	1-103658-8	1-103659-8	1-103893-8	1-103660-8	1-103661-8	1-103653-8
20	2.095 [53.21]	1-103894-9	1-103658-9	1-103659-9	1-103893-9	1-103660-9	1-103661-9	1-103653-9
21	2.195 [55.75]	2-103894-0	2-103658-0	2-103659-0	2-103893-0	2-103660-0	2-103661-0	2-103653-0
22	2.295 [58.29]	2-103894-1	2-103658-1	2-103659-1	2-103893-1	2-103660-1	2-103661-1	2-103653-1
23	2.395 [60.83]	2-103894-2	2-103658-2	2-103659-2	2-103893-2	2-103660-2	2-103661-2	2-103653-2
24	2.495 [63.37]	2-103894-3	2-103658-3	2-103659-3	2-103893-3	2-103660-3	2-103661-3	2-103653-3
25	2.595 [65.91]	2-103894-4	2-103658-4	2-103659-4	2-103893-4	2-103660-4	2-103661-4	2-103653-4

Notes: 1. Pin assemblies are furnished with strip contacts partially inserted into housing—contacts latched into “preload” windows. Contacts are fully inserted into housings automatically when terminated with AMP application machines, or manually when terminated with AMP pistol grip hand tool.
 2. Use **Extraction/Lance Reset Tool No. 843477-1** to remove pin contacts.

MTE Pin Assemblies

5

**MTE Pin Assemblies—Guide Ribs,
Single-Row, .100 [2.54] Centerline**



Preassembled housings in strip form are available in positions 2 thru 12. For ease of handling, positions 2 thru 5 are recommended when using the Tyco Electronics Manual Pistol Grip Tool.

Material and Finish:

Housing—Black thermoplastic, 94V-0 rated

Contacts—Phosphor Bronze, plated as follows:

Plating A—Duplex plated .000030 [0.00076] gold on contact area, .000050 [0.00127] min. tin-lead in crimp area, with entire contact underplated .000050 [0.00127] nickel

Plating B—Duplex plated .000015 [0.00038] gold on contact area, .000050 [0.00127] min. tin-lead in crimp area, with entire contact underplated .000050 [0.00127] nickel

Plating C—.000100 [0.00254] bright tin-lead over .000050 [0.00127] nickel on entire contact

Note: Insulation displacement contacts accept an insulation diameter of .030 [0.76] min. to .054 [1.37] max. with an insulation wall thickness of .015 [0.38] max.

Related Product Data:

Mateable AMPMODU MTE Products (with Pin Assembly Installed in Panel Mount Pin Shroud): pages 259, 260

Receptacle Assemblies (Polarized/Latching)— pages 247, 248

Receptacle Assemblies with Guide Ribs (installed in Single Coupling Shroud)—pages 249, 250, 252, 257

Interchangeable Crimp Contacts—page 273

Application Tooling—pages 291, 292

Performance Specifications—page 242

Technical Documents (pages 295, 296):

Product Specification
108-25034

Application Specification
114-25026

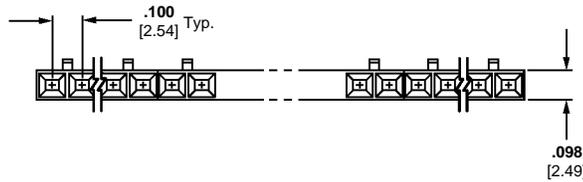
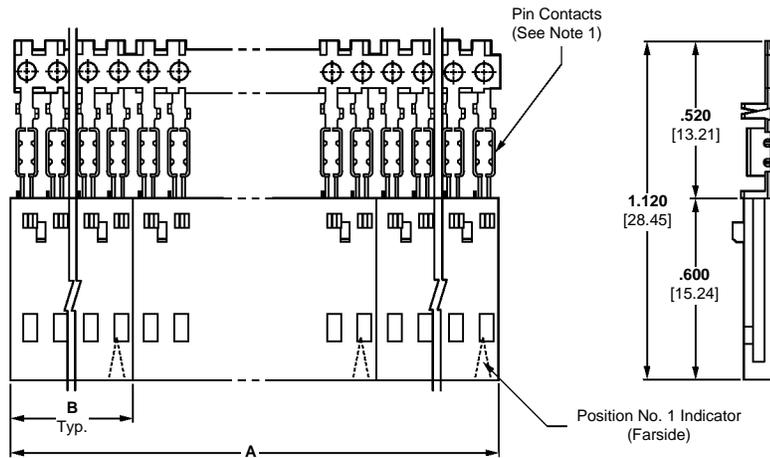

**MTE Pin Assemblies—Strip Form with Guide Ribs,
Single-Row, .100 [2.54] Centerline** (Continued)

No. of Pos.	Dimensions		Housing Quantities Per Strip Segment	Strip Form Pin Assembly 30-26 AWG [0.05-0.15mm ²] Wire			Strip Form Pin Assembly 26-22 AWG [0.12-0.3mm ²] Wire			Unloaded Housings
	A	B		Plating A	Plating B	Plating C	Plating A	Plating B	Plating C	
2	1.980 [50.29]	0.198 [5.03]	10	103955-1	103954-1	103953-1	103952-1	103951-1	103950-1	104503-1
3	1.490 [37.85]	0.298 [7.57]	5	103955-2	103954-2	103953-2	103952-2	103951-2	103950-2	104503-2
4	1.990 [50.55]	0.398 [10.11]	5	103955-3	103954-3	103953-3	103952-3	103951-3	103950-3	104503-3
5	1.990 [50.55]	0.498 [12.65]	4	103955-4	103954-4	103953-4	103952-4	103951-4	103950-4	104503-4
6	2.390 [60.71]	0.598 [15.19]	4	103955-5	103954-5	103953-5	103952-5	103951-5	103950-5	104503-5
7	1.400 [35.56]	0.698 [17.73]	2	103955-6	103954-6	103953-6	103952-6	103951-6	103950-6	104503-6
8	1.600 [40.64]	0.798 [20.27]	2	103955-7	103954-7	103953-7	103952-7	103951-7	103950-7	104503-7
9	1.800 [45.72]	0.898 [22.81]	2	103955-8	103954-8	103953-8	103952-8	103951-8	103950-8	104503-8
10	2.000 [50.80]	0.998 [25.35]	2	103955-9	103954-9	103953-9	103952-9	103951-9	103950-9	104503-9
11	2.200 [55.88]	1.098 [27.89]	2	1-103955-0	1-103954-0	1-103953-0	1-103952-0	1-103951-0	1-103950-0	1-104503-0
12	2.400 [60.96]	1.198 [30.43]	2	1-103955-1	1-103954-1	1-103953-1	1-103952-1	1-103951-1	1-103950-1	1-104503-1

**MTE Pin Assemblies—Individual Form with Guide Ribs,
Single-Row, .100 [2.54] Centerline**

No. of Pos.	Dimensions B	Individual Pin Assembly 30-26 AWG [0.05-0.15mm ²] Wire			Individual Pin Assembly 26-22 AWG [0.12-0.3mm ²] Wire			Unloaded Housings
		Plating A	Plating B	Plating C	Plating A	Plating B	Plating C	
13	1.398 [35.51]	1-103896-2	1-103657-2	1-103656-2	1-103895-2	1-103655-2	1-103654-2	1-104503-2
14	1.498 [38.05]	1-103896-3	1-103657-3	1-103656-3	1-103895-3	1-103655-3	1-103654-3	1-104503-3
15	1.598 [40.59]	1-103896-4	1-103657-4	1-103656-4	1-103895-4	1-103655-4	1-103654-4	1-104503-4
16	1.698 [43.13]	1-103896-5	1-103657-5	1-103656-5	1-103895-5	1-103655-5	1-103654-5	1-104503-5
17	1.798 [45.67]	1-103896-6	1-103657-6	1-103656-6	1-103895-6	1-103655-6	1-103654-6	1-104503-6
18	1.898 [48.20]	1-103896-7	1-103657-7	1-103656-7	1-103895-7	1-103655-7	1-103654-7	1-104503-7
19	1.998 [50.75]	1-103896-8	1-103657-8	1-103656-8	1-103895-8	1-103655-8	1-103654-8	1-104503-8
20	2.098 [53.29]	1-103896-9	1-103657-9	1-103656-9	1-103895-9	1-103655-9	1-103654-9	1-104503-9
21	2.198 [55.83]	2-103896-0	2-103657-0	2-103656-0	2-103895-0	2-103655-0	2-103654-0	2-104503-0
22	2.298 [58.37]	2-103896-1	2-103657-1	2-103656-1	2-103895-1	2-103655-1	2-103654-1	2-104503-1
23	2.398 [60.91]	2-103896-2	2-103657-2	2-103656-2	2-103895-2	2-103655-2	2-103654-2	2-104503-2
24	2.498 [63.45]	2-103896-3	2-103657-3	2-103656-3	2-103895-3	2-103655-3	2-103654-3	2-104503-3
25	2.598 [65.99]	2-103896-4	2-103657-4	2-103656-4	2-103895-4	2-103655-4	2-103654-4	2-104503-4

Notes: 1. Pin assemblies are furnished with strip contacts partially inserted into housing—contacts latched into "preload" windows. Contacts are fully inserted into housings automatically when terminated with AMP application machines, or manually when terminated with AMP pistol grip hand tool.
2. Use **Extraction/Lance Reset Tool No. 843477-1** to remove pin contacts.

MTE Pin Assemblies

5

Coupling Shrouds for MTE Receptacle Assemblies with Guide Ribs

Single-Row

Material:

Black thermoplastic, 94V-0 rated

Technical Documents
(pages 295, 296):

Product Specification
108-25034

Application Specification
114-25026

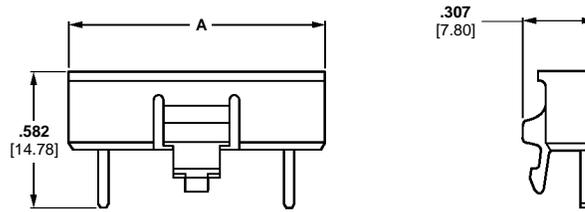

No. of Pos.	Dimension A	Single-Row Coupling Shroud
4	.485 [12.32]	103680-1
5	.585 [14.86]	103680-2
6	.685 [17.40]	103680-3
7	.785 [19.94]	103680-4
8	.885 [22.48]	103680-5
9	.985 [25.02]	103680-6
10	1.085 [27.56]	103680-7
11	1.185 [30.10]	103680-8
12	1.285 [32.64]	103680-9
13	1.385 [35.18]	1-103680-0
14	1.485 [37.72]	1-103680-1

No. of Pos.	Dimension A	Single-Row Coupling Shroud
15	1.585 [40.26]	1-103680-2
16	1.685 [42.80]	1-103680-3
17	1.785 [45.34]	1-103680-4
18	1.885 [47.88]	1-103680-5
19	1.985 [50.42]	1-103680-6
20	2.085 [52.96]	1-103680-7
21	2.185 [55.50]	1-103680-8
22	2.285 [58.04]	1-103680-9
23	2.385 [60.58]	2-103680-0
24	2.485 [63.12]	2-103680-1
25	2.585 [65.66]	2-103680-2

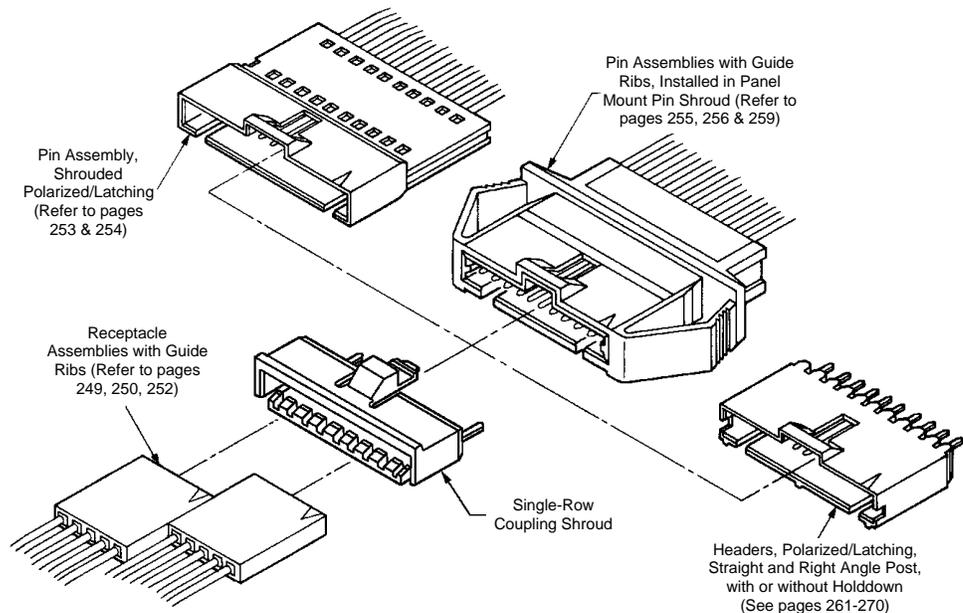

Typical Application of Single-Row Coupling Shroud and Mating AMPMODU MTE Products

MTE Coupling Shrouds

5

Coupling Shrouds for MTE Receptacle Assemblies with Guide Ribs (Continued)

Double-Row

Material:

Black thermoplastic, 94V-0 rated

Technical Documents (pages 295, 296):

Product Specification
108-25034

Application Specification
114-25026

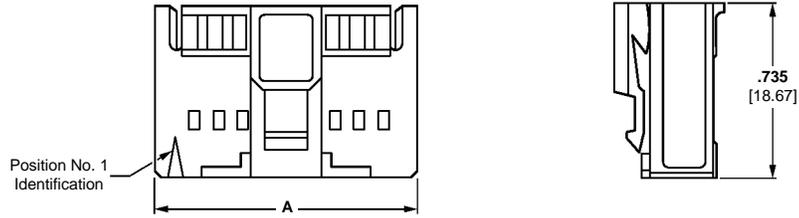

No. of Pos.	Dimension A	Double-Row Coupling Shroud
8	.585 [14.86]	103681-1
10	.685 [17.40]	103681-2
12	.785 [19.94]	103681-3
14	.885 [22.48]	103681-4
16	.985 [25.02]	103681-5
18	1.085 [27.56]	104500-1
20	1.185 [30.10]	104500-2
22	1.285 [32.64]	104500-3
24	1.385 [35.18]	104500-4
26	1.485 [37.72]	104500-5
28	1.585 [40.26]	104500-6
30	1.685 [42.80]	104500-7
32	1.785 [45.34]	104500-8
34	1.885 [47.88]	104500-9
40	2.185 [55.50]	1-104500-0
50	2.685 [68.20]	1-104500-1

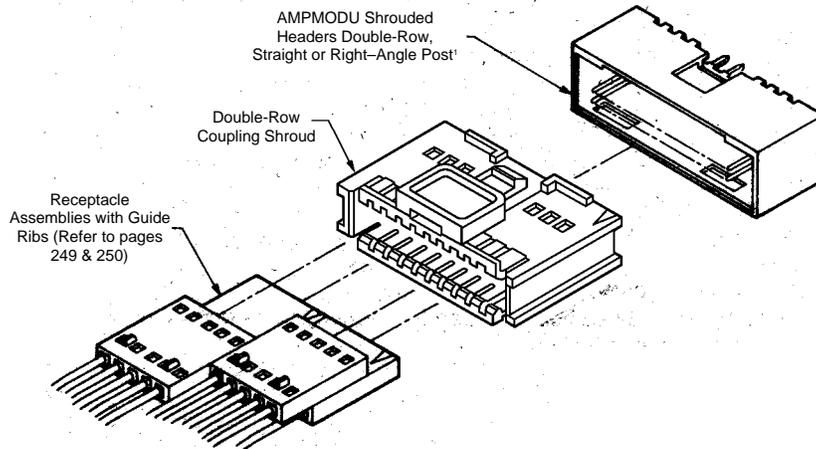

*Mating AMPMODU Double-Row Shrouded Headers must have .318 [8.08] mating post length and .150 [3.81] dimension from centerline of last post to inside of end shroud wall.

Typical Application of Double-Row Coupling Shroud and Mating AMPMODU Products

Panel Mount Pin Shrouds for MTE Pin Assemblies with Guide Ribs, Single-Row

Material:

Black thermoplastic, 94V-0 rated

Technical Documents (pages 295, 296):

Product Specification
108-25034

Application Specification
114-25026

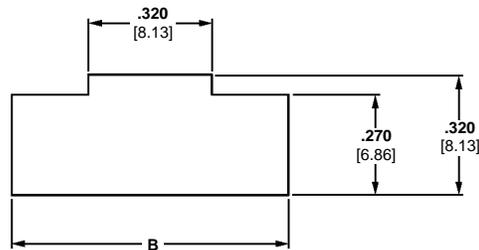
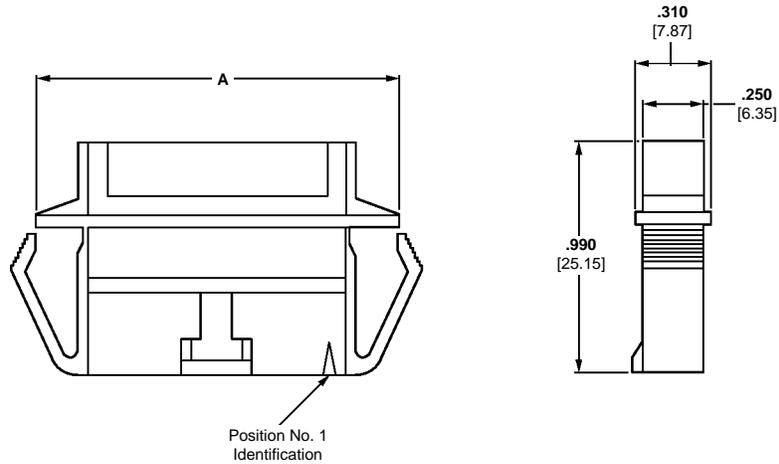

No. of Pos.	Dimensions		Panel Mount Pin Shroud
	A	B	
2	.735 [18.67]	.625 [15.88]	103682-1
3	.835 [21.21]	.725 [18.42]	103682-2
4	.935 [23.75]	.825 [20.96]	103682-3
5	1.035 [26.29]	.925 [23.50]	103682-4
6	1.135 [28.83]	1.025 [26.04]	103682-5
7	1.235 [31.37]	1.125 [28.58]	103682-6
8	1.335 [33.91]	1.225 [31.12]	103682-7
9	1.435 [36.45]	1.325 [33.66]	103682-8
10	1.535 [38.99]	1.425 [36.20]	103682-9
11	1.635 [41.53]	1.525 [38.74]	1-103682-0
12	1.735 [44.07]	1.625 [41.28]	1-103682-1
13	1.835 [46.61]	1.725 [43.82]	1-103682-2

No. of Pos.	Dimensions		Panel Mount Pin Shroud
	A	B	
14	1.935 [49.15]	1.825 [46.36]	1-103682-3
15	2.035 [51.69]	1.925 [48.90]	1-103682-4
16	2.135 [54.23]	2.025 [51.44]	1-103682-5
17	2.235 [56.77]	2.125 [53.98]	1-103682-6
18	2.335 [59.31]	2.225 [56.52]	1-103682-7
19	2.435 [61.85]	2.325 [59.06]	1-103682-8
20	2.535 [64.39]	2.425 [61.60]	1-103682-9
21	2.635 [66.93]	2.525 [64.14]	2-103682-0
22	2.735 [69.47]	2.625 [66.68]	2-103682-1
23	2.835 [72.01]	2.725 [69.22]	2-103682-2
24	2.935 [74.55]	2.825 [71.76]	2-103682-3
25	3.035 [77.09]	2.925 [74.30]	2-103682-4

Panel Mount Pin Shrouds for MTE Pin Assemblies with Guide Ribs, Single-Row (Continued)

Material:

Black thermoplastic, 94V-0 rated

Technical Documents (pages 295, 296):

Product Specification
108-25034

Application Specification
114-25026

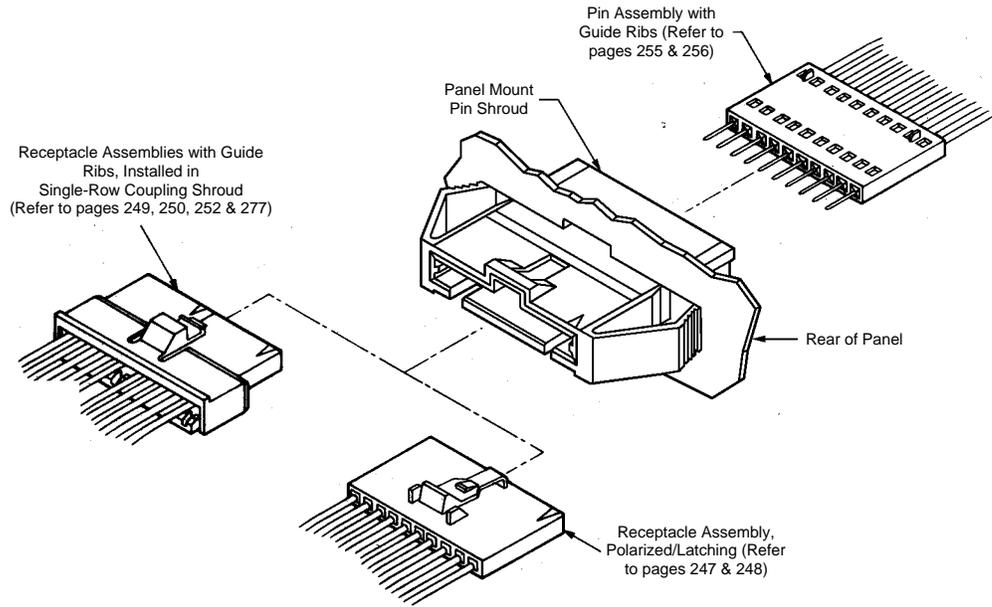

Typical Application of Panel Mount Pin Shroud and Mating AMPMODU Products

**MTE Headers, Shrouded Polarized/Latching,
Single-Row .100 [2.54] Centerline**

**.025 [0.64] Square
Straight Post (With or
Without Swaged Tail)**

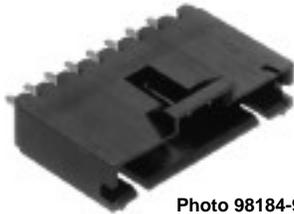
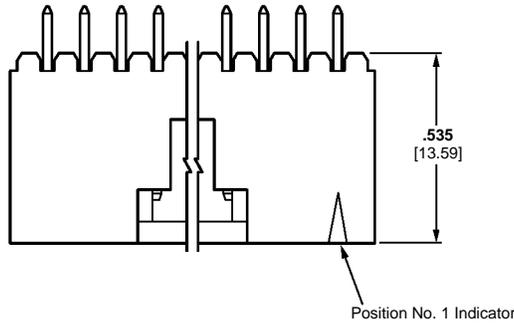

Photo 98184-9



Swaged Retention Tail
(See Note)

Material and Finish:

Housing—Black thermoplastic,
94V-0 rated

Posts—Copper alloy, plated as follows:

Plating A—Duplex plated .000030
[0.00076] gold on contact area, .000100
[0.00254] min. tin-lead on solder area,
with entire post underplated .000050
[0.00127] nickel

Plating B—Duplex plated .000015
[0.00038] gold on contact area, .000100
[0.00254] min. tin-lead on solder area,
with entire post underplated .000050
[0.00127] nickel

Plating C—.000100 [0.00254] tin-lead
over .000050 [0.00127] nickel on entire
post

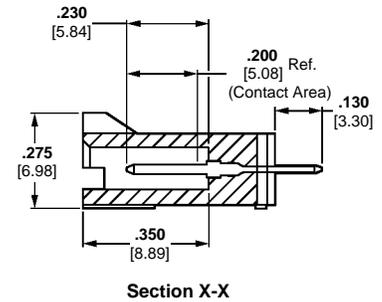
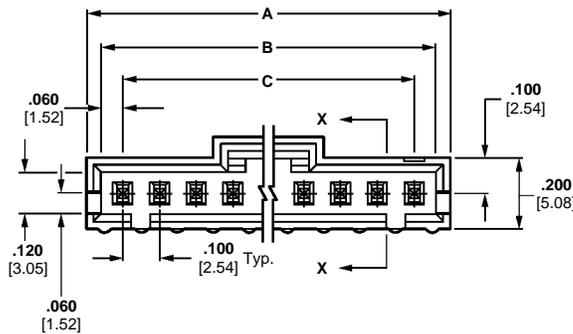

Related Product Data:

**Mateable AMPMODU MTE
Products:**

**Receptacle Assemblies
(Polarized/Latching)**—
pages 247, 248

**Receptacle Assemblies with Guide
Ribs (installed in Single-Row
Coupling Shroud)**—
pages 249, 250, 252, 257

Other Mateable Connectors:

Flexible Film Connectors—
Catalog 82007

Technical Documents (pages
295, 296):

Product Specification
108-25034

Application Specification
114-25026

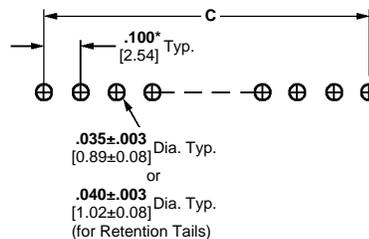

Recommended PC Board Hole Layout

*±.003 [±0.08]; tolerances not to accumulate within one connector pattern.

Note: Swaged retention tails are provided in a minimum of two locations per header.

**MTE Headers, Shrouded Polarized/Latching,
Single-Row .100 [2.54] Centerline** (Continued)

No. of Pos.	Dimensions			Polarized/Latching Header With Swage			Polarized/Latching Header Without Swage		
	A	B	C	Plating A	Plating B	Plating C	Plating A	Plating B	Plating C
2	.300 [7.62]	.220 [5.59]	.100 [2.54]	103908-1	103670-1	103669-1	103735-1	103638-1	103639-1
3	.400 [10.16]	.320 [8.13]	.200 [5.08]	103908-2	103670-2	103669-2	103735-2	103638-2	103639-2
4	.500 [12.70]	.420 [10.67]	.300 [7.62]	103908-3	103670-3	103669-3	103735-3	103638-3	103639-3
5	.600 [15.24]	.520 [13.21]	.400 [10.16]	103908-4	103670-4	103669-4	103735-4	103638-4	103639-4
6	.700 [17.78]	.620 [15.75]	.500 [12.70]	103908-5	103670-5	103669-5	103735-5	103638-5	103639-5
7	.800 [20.32]	.720 [18.29]	.600 [15.24]	103908-6	103670-6	103669-6	103735-6	103638-6	103639-6
8	.900 [22.86]	.820 [20.83]	.700 [17.78]	103908-7	103670-7	103669-7	103735-7	103638-7	103639-7
9	1.000 [25.40]	.920 [23.37]	.800 [20.32]	103908-8	103670-8	103669-8	103735-8	103638-8	103639-8
10	1.100 [27.94]	1.020 [25.91]	.900 [22.86]	103908-9	103670-9	103669-9	103735-9	103638-9	103639-9
11	1.200 [30.48]	1.120 [28.45]	1.000 [25.40]	1-103908-0	1-103670-0	1-103669-0	1-103735-0	1-103638-0	1-103639-0
12	1.300 [33.02]	1.220 [30.99]	1.100 [27.94]	1-103908-1	1-103670-1	1-103669-1	1-103735-1	1-103638-1	1-103639-1
13	1.400 [35.56]	1.320 [33.53]	1.200 [30.48]	1-103908-2	1-103670-2	1-103669-2	1-103735-2	1-103638-2	1-103639-2
14	1.500 [38.10]	1.420 [36.07]	1.300 [33.02]	1-103908-3	1-103670-3	1-103669-3	1-103735-3	1-103638-3	1-103639-3
15	1.600 [40.64]	1.520 [38.61]	1.400 [35.56]	1-103908-4	1-103670-4	1-103669-4	1-103735-4	1-103638-4	1-103639-4
16	1.700 [43.18]	1.620 [41.15]	1.500 [38.10]	1-103908-5	1-103670-5	1-103669-5	1-103735-5	1-103638-5	1-103639-5
17	1.800 [45.72]	1.720 [43.69]	1.600 [40.64]	1-103908-6	1-103670-6	1-103669-6	1-103735-6	1-103638-6	1-103639-6
18	1.900 [48.26]	1.820 [46.23]	1.700 [43.18]	1-103908-7	1-103670-7	1-103669-7	1-103735-7	1-103638-7	1-103639-7
19	2.000 [50.80]	1.920 [48.77]	1.800 [45.72]	1-103908-8	1-103670-8	1-103669-8	1-103735-8	1-103638-8	1-103639-8
20	2.100 [53.34]	2.020 [51.31]	1.900 [48.26]	1-103908-9	1-103670-9	1-103669-9	1-103735-9	1-103638-9	1-103639-9
21	2.200 [55.88]	2.120 [53.85]	2.000 [50.80]	2-103908-0	2-103670-0	2-103669-0	2-103735-0	2-103638-0	2-103639-0
22	2.300 [58.42]	2.220 [56.39]	2.100 [53.34]	2-103908-1	2-103670-1	2-103669-1	2-103735-1	2-103638-1	2-103639-1
23	2.400 [60.96]	2.320 [58.93]	2.200 [55.88]	2-103908-2	2-103670-2	2-103669-2	2-103735-2	2-103638-2	2-103639-2
24	2.500 [63.50]	2.420 [61.47]	2.300 [58.42]	2-103908-3	2-103670-3	2-103669-3	2-103735-3	2-103638-3	2-103639-3
25	2.600 [66.04]	2.520 [64.01]	2.400 [60.96]	2-103908-4	2-103670-4	2-103669-4	2-103735-4	2-103638-4	2-103639-4

Notes: 1. Selectively loaded headers are available, consult Tyco Electronics.
2. Use Keying Tool No. 91417-1 to remove post for keying.

MTE Headers, Shrouded Latching, Single-Row .100 [2.54] Centerline

.025 [0.64] Square Right-Angle Post



Material and Finish:

Housing—Black thermoplastic, 94V-0 rated

Posts—Copper alloy, plated as follows:

Plating A—Duplex plated .000030 [0.00076] gold on contact area, .000100 [0.00254] min. tin-lead on solder area, with entire post underplated .000050 [0.00127] nickel

Plating B—Duplex plated .000015 [0.00038] gold on contact area, .000100 [0.00254] min. tin-lead on solder area, with entire post underplated .000050 [0.00127] nickel

Plating C—.000100 [0.00254] tin-lead over .000050 [0.00127] nickel on entire post

With Holddown

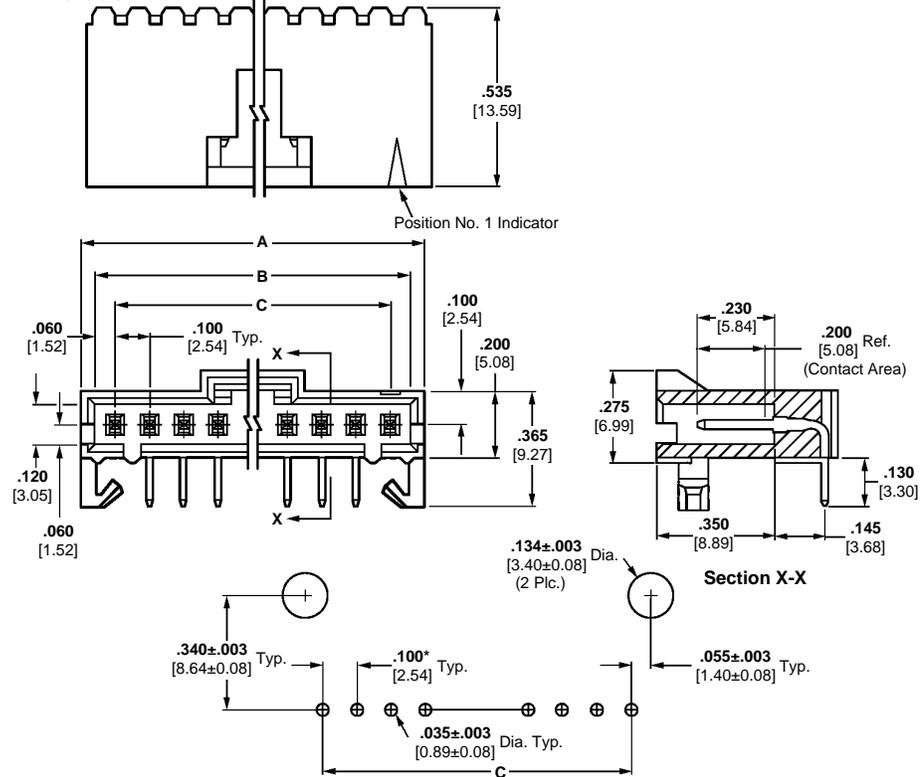

Recommended PC Board Hole Layout
(PC board thickness (for Holddown Feature) is $.062 \pm .008$ [1.57 ± 0.20])
*±.003 [±0.08]; tolerance not to accumulate within one connector pattern.



Related Product Data:

Mateable AMPMODU MTE Products:

Receptacle Assemblies (Latching)—pages 247, 248

Receptacle Assemblies with Guide Ribs (installed in Single-Row Coupling Shroud)—pages 249, 250, 252, 257

Other Mateable Connectors:

Flexible Film Connectors—Catalog 82007

Technical Documents (pages 295, 296):

Product Specification
108-25034

Application Specification
114-25026

Without Holddown

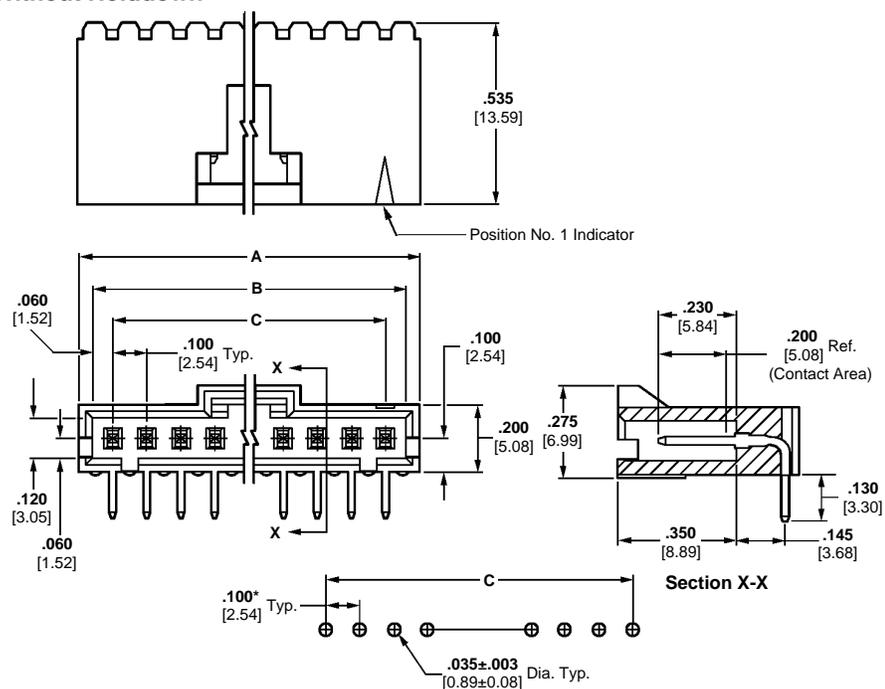

Recommended PC Board Hole Layout
*±.003 [±0.08]; tolerance not to accumulate within one connector pattern.

MTE Headers, Shrouded Latching, Single-Row .100 [2.54] Centerline (Continued)

No. of Pos.	Dimensions			Latching Header With Hold Down			Latching Header Without Hold Down		
	A	B	C	Plating A	Plating B	Plating C	Plating A	Plating B	Plating C
2	.300 [7.62]	.220 [5.59]	.100 [2.54]	103904-1	103673-1	103672-1	103906-1	103635-1	103634-1
3	.400 [10.16]	.320 [8.13]	.200 [5.08]	103904-2	103673-2	103672-2	103906-2	103635-2	103634-2
4	.500 [12.70]	.420 [10.67]	.300 [7.62]	103904-3	103673-3	103672-3	103906-3	103635-3	103634-3
5	.600 [15.24]	.520 [13.21]	.400 [10.16]	103904-4	103673-4	103672-4	103906-4	103635-4	103634-4
6	.700 [17.78]	.620 [15.75]	.500 [12.70]	103904-5	103673-5	103672-5	103906-5	103635-5	103634-5
7	.800 [20.32]	.720 [18.29]	.600 [15.24]	103904-6	103673-6	103672-6	103906-6	103635-6	103634-6
8	.900 [22.86]	.820 [20.83]	.700 [17.78]	103904-7	103673-7	103672-7	103906-7	103635-7	103634-7
9	1.000 [25.40]	.920 [23.37]	.800 [20.32]	103904-8	103673-8	103672-8	103906-8	103635-8	103634-8
10	1.100 [27.94]	1.020 [25.91]	.900 [22.86]	103904-9	103673-9	103672-9	103906-9	103635-9	103634-9
11	1.200 [30.48]	1.120 [28.45]	1.000 [25.40]	1-103904-0	1-103673-0	1-103672-0	1-103906-0	1-103635-0	1-103634-0
12	1.300 [33.02]	1.220 [30.99]	1.100 [27.94]	1-103904-1	1-103673-1	1-103672-1	1-103906-1	1-103635-1	1-103634-1
13	1.400 [35.56]	1.320 [33.53]	1.200 [30.48]	1-103904-2	1-103673-2	1-103672-2	1-103906-2	1-103635-2	1-103634-2
14	1.500 [38.10]	1.420 [36.07]	1.300 [33.02]	1-103904-3	1-103673-3	1-103672-3	1-103906-3	1-103635-3	1-103634-3
15	1.600 [40.64]	1.520 [38.61]	1.400 [35.56]	1-103904-4	1-103673-4	1-103672-4	1-103906-4	1-103635-4	1-103634-4
16	1.700 [43.18]	1.620 [41.15]	1.500 [38.10]	1-103904-5	1-103673-5	1-103672-5	1-103906-5	1-103635-5	1-103634-5
17	1.800 [45.72]	1.720 [43.69]	1.600 [40.64]	1-103904-6	1-103673-6	1-103672-6	1-103906-6	1-103635-6	1-103634-6
18	1.900 [48.26]	1.820 [46.23]	1.700 [43.18]	1-103904-7	1-103673-7	1-103672-7	1-103906-7	1-103635-7	1-103634-7
19	2.000 [50.80]	1.920 [48.77]	1.800 [45.72]	1-103904-8	1-103673-8	1-103672-8	1-103906-8	1-103635-8	1-103634-8
20	2.100 [53.34]	2.020 [51.31]	1.900 [48.26]	1-103904-9	1-103673-9	1-103672-9	1-103906-9	1-103635-9	1-103634-9
21	2.200 [55.88]	2.120 [53.85]	2.000 [50.80]	2-103904-0	2-103673-0	2-103672-0	2-103906-0	2-103635-0	2-103634-0
22	2.300 [58.42]	2.220 [56.39]	2.100 [53.34]	2-103904-1	2-103673-1	2-103672-1	2-103906-1	2-103635-1	2-103634-1
23	2.400 [60.96]	2.320 [58.93]	2.200 [55.88]	2-103904-2	2-103673-2	2-103672-2	2-103906-2	2-103635-2	2-103634-2
24	2.500 [63.50]	2.420 [61.47]	2.300 [58.42]	2-103904-3	2-103673-3	2-103672-3	2-103906-3	2-103635-3	2-103634-3
25	2.600 [66.04]	2.520 [64.01]	2.400 [60.96]	2-103904-4	2-103673-4	2-103672-4	2-103906-4	2-103635-4	2-103634-4

Notes: 1. Selectively loaded headers are available, consult Tyco Electronics.
 2. Use Keying Tool No. 91471-1 to remove post for keying.

MTE Headers

5

MTE Headers, Shrouded Latching, Single-Row .100 [2.54] Centerline

.025 [0.64] Square Straight Post (With Swaged Tails and PC Board Orientation)



Photo 98184-5

Material and Finish:

Housing—Black thermoplastic, 94V-0 rated

Posts—Copper alloy, plated .000100-.000200 [0.00254-0.00508] tin-lead over .000050 [0.00127] nickel on entire post

Related Product Data:

Mateable AMPMODU MTE Products:

Receptacle Assemblies (Polarized/Latching)— pages 247, 248

Receptacle Assemblies with Guide Ribs (installed in Single-Row Coupling Shroud)— pages 249, 250, 252, 257

Other Mateable Connectors:

Flexible Film Connectors— Catalog 82007

Technical Documents (pages 295, 296):

Product Specification 108-25034

Application Specification 114-25026

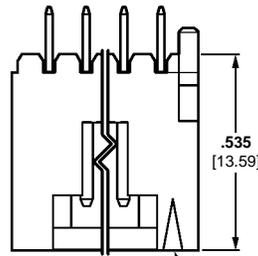

Position No. 1 Indicator



Swaged Retention Tail (See Note)

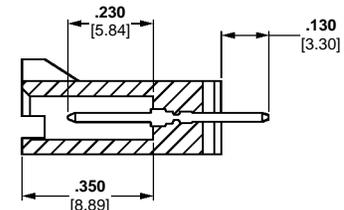
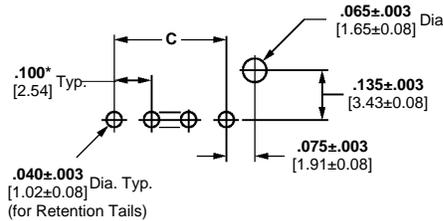
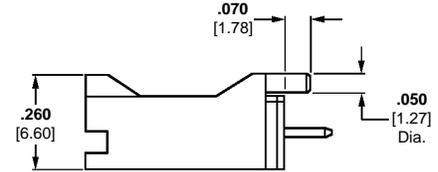
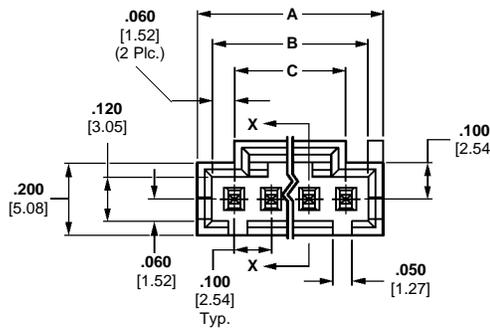

Section X-X

Recommended PC Board Hole Layout

*±.003 [±0.08]; tolerances not to accumulate within one connector pattern.

Note: Swaged retention tails are provided in a minimum of two locations per header.

No. of Pos.	Dimensions			Latching Header
	A	B	C	
2	.300 [7.62]	.220 [5.59]	.100 [2.54]	104450-1
3	.400 [10.16]	.320 [8.13]	.200 [5.08]	104450-2
4	.500 [12.70]	.420 [10.67]	.300 [7.62]	104450-3
5	.600 [15.24]	.520 [13.21]	.400 [10.16]	104450-4
6	.700 [17.78]	.620 [15.75]	.500 [12.70]	104450-5
7	.800 [20.32]	.720 [18.29]	.600 [15.24]	104450-6
8	.900 [22.86]	.820 [20.83]	.700 [17.78]	104450-7
9	1.000 [25.40]	.920 [23.37]	.800 [20.32]	104450-8
10	1.100 [27.94]	1.020 [25.91]	.900 [22.86]	104450-9

**MTE Headers, High-Temp, Shrouded Polarized/Latching,
Single-Row .100 [2.54] Centerline**

.025 [0.64] Square Straight Post (With Swaged Tails and PC Board Orientation)

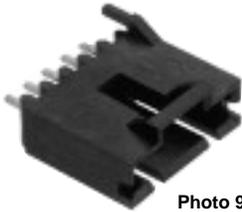

Photo 98184-5

Material and Finish:

Housing—Black thermoplastic, 94V-0 rated

Posts—Copper alloy, duplex plated .000015 [0.00038] gold on contact area, .000100-.000200 [0.00254-0.00508] matte tin-lead on solder tail, with entire post underplated .000050 [0.00127] nickel

Related Product Data:

Mateable AMPMODU MTE Products:

Receptacle Assemblies with Guide Ribs (installed in Single-Row Coupling Shroud)—pages 249, 250, 252, 257

Receptacle Assemblies (Polarized Latching)—pages 247, 248

Other Mateable Connectors:
Flexible Film Connectors—Catalog 82007

Technical Documents (pages 295, 296):

Product Specification
108-25034

Application Specification
114-25026

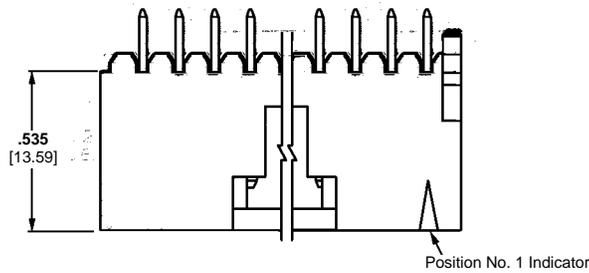

Swaged Retention Tail (See Note)

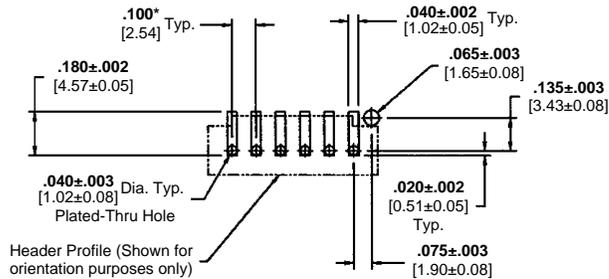
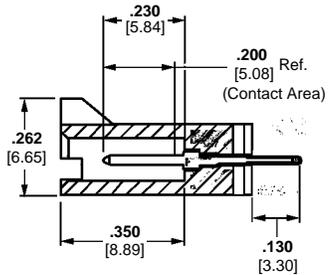
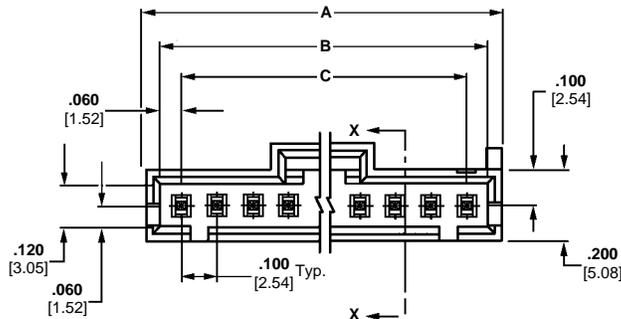

Recommended PC Board Hole Layout (Stencil Thickness = .010 [0.25])

*±.003 [±0.08] tolerance not to accumulate within one connector pattern

No. of Pos.	Dimensions			Polarized/Latching Header, High-Temp
	A	B	C	
2	.300 [7.62]	.220 [5.59]	.100 [2.54]	104809-1
3	.400 [10.16]	.320 [8.13]	.200 [5.08]	104809-2
4	.500 [12.70]	.420 [10.67]	.300 [7.62]	104809-3
5	.600 [15.24]	.520 [13.21]	.400 [10.16]	104809-4
6	.700 [17.78]	.620 [15.75]	.500 [12.70]	104809-5
7	.800 [20.32]	.720 [18.29]	.600 [15.24]	104809-6
8	.900 [22.86]	.820 [20.83]	.700 [17.78]	104809-7
9	1.000 [25.40]	.920 [23.37]	.800 [20.32]	104809-8
10	1.100 [27.94]	1.020 [25.91]	.900 [22.86]	104809-9
11	1.200 [30.48]	1.120 [28.45]	1.000 [25.40]	1-104809-0
12	1.300 [33.02]	1.220 [30.99]	1.100 [27.94]	1-104809-1

**MTE Headers, Shrouded High-Temp, Polarized/Latching
(Thru-Hole, SMT Compatible) Single-Row, .100 [2.54] Centerline**

**.025 [0.64] Square
Straight Post (With or
Without Swaged Tail)**



Material and Finish:

Housing—Black thermoplastic, high temperature, 94V-0 rated

Posts—Copper alloy, duplex plated .000015 [0.00038] gold on contact area, .000100-.000200 [0.00254-0.00508] matte tin-lead on solder tail, with entire post underplated .000050 [0.00127] nickel

Related Product Data:

Mateable AMPMODU MTE Products:

Receptacle Assemblies (Polarized/Latching)—pages 247, 248

Receptacle Assemblies with Guide Ribs (installed in Single-Row Coupling Shroud)—pages 249, 250, 252, 257

Other Mateable Connectors:

Flexible Film Connectors—Catalog 82007

Technical Documents (pages 295, 296):

Product Specification
108-25034

Application Specification
114-25026

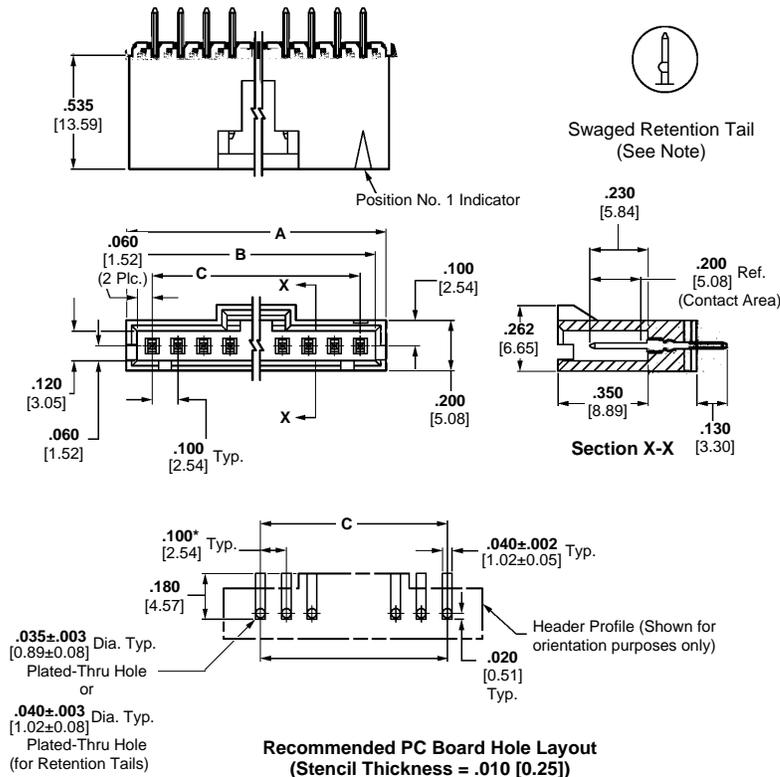

*±.003 [±0.08]; tolerance not to accumulate within one connector pattern.

Note: Swaged retention tails in Holddown versions only. Retention tails are provided in a minimum of two locations per header.

No. of Pos.	Dimensions			Straight Header	
	A	B	C	With Swage	Without Swage
2	.300 [7.62]	.220 [5.59]	.100 [2.54]	104362-1	104363-1
3	.400 [10.16]	.320 [8.13]	.200 [5.08]	104362-2	104363-2
4	.500 [12.70]	.420 [10.67]	.300 [7.62]	104362-3	104363-3
5	.600 [15.24]	.520 [13.21]	.400 [10.16]	104362-4	104363-4
6	.700 [17.78]	.620 [15.75]	.500 [12.70]	104362-5	104363-5
7	.800 [20.32]	.720 [18.29]	.600 [15.24]	104362-6	104363-6
8	.900 [22.86]	.820 [20.83]	.700 [17.78]	104362-7	104363-7
9	1.000 [25.40]	.920 [23.37]	.800 [20.32]	104362-8	104363-8
10	1.100 [27.94]	1.020 [25.91]	.900 [22.86]	104362-9	104363-9
11	1.200 [30.48]	1.120 [28.45]	1.000 [25.40]	1-104362-0	1-104363-0
12	1.300 [33.02]	1.220 [30.99]	1.100 [27.94]	1-104362-1	1-104363-1
13	1.400 [35.56]	1.320 [33.53]	1.200 [30.48]	1-104909-2	1-104910-2
14	1.500 [38.10]	1.420 [36.07]	1.300 [33.02]	1-104909-3	1-104910-3
15	1.600 [40.64]	1.520 [38.61]	1.400 [35.56]	1-104909-4	1-104910-4
16	1.700 [43.18]	1.620 [41.15]	1.500 [38.10]	1-104909-5	1-104910-5
17	1.800 [45.72]	1.720 [43.69]	1.600 [40.64]	1-104909-6	1-104910-6
18	1.900 [48.26]	1.820 [46.23]	1.700 [43.18]	1-104909-7	1-104910-7
19	2.000 [50.80]	1.920 [48.77]	1.800 [45.72]	1-104909-8	1-104910-8
20	2.100 [53.34]	2.020 [51.31]	1.900 [48.26]	1-104909-9	1-104910-9
21	2.200 [55.88]	2.120 [53.85]	2.000 [50.80]	2-104909-0	2-104910-0
22	2.300 [58.42]	2.220 [56.39]	2.100 [53.34]	2-104909-1	2-104910-1
23	2.400 [60.96]	2.320 [58.93]	2.200 [55.88]	2-104909-2	2-104910-2
24	2.500 [63.50]	2.420 [61.47]	2.300 [58.42]	2-104909-3	2-104910-3
25	2.600 [66.04]	2.520 [64.01]	2.400 [60.96]	2-104909-4	2-104910-4

Note: Use Keying Tool No. 91417-1 to remove post for keying.

MTE Headers, Shrouded High-Temp, Polarized/Latching (Thru-Hole, SMT Compatible) Single-Row, .100 [2.54] Centerline (Continued)

.025 [0.64] Square Right-Angle Post (With Holddown)



Material and Finish:

Housing—Black thermoplastic, high temperature, 94V-0 rated
Posts—Copper alloy, duplex plated .000015 [0.00038] gold on contact area, .000100-.000200 [0.00254-0.00508] matte tin-lead on solder tail, with entire post underplated .000050 [0.00127] nickel

Related Product Data:

Mateable AMPMODU MTE Products:

Receptacle Assemblies (Polarized/Latching)—pages 247, 248

Receptacle Assemblies with Guide Ribs (installed in Single-Row Coupling Shroud)—pages 249, 250, 252, 257

Other Mateable Connectors:
Flexible Film Connectors—Catalog 82007

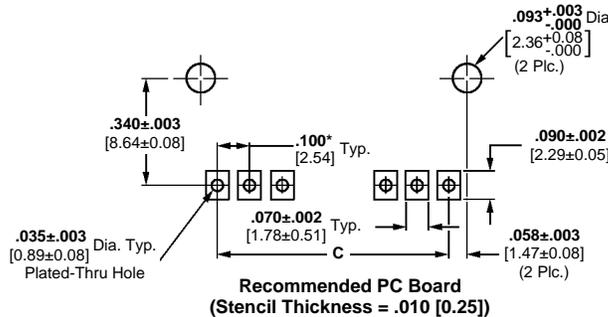
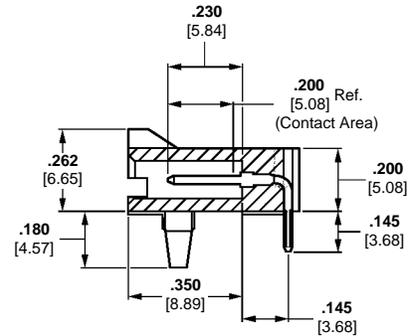
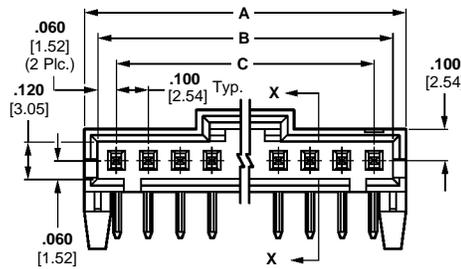
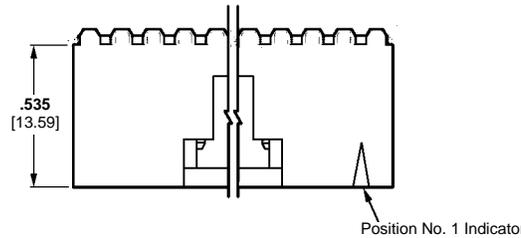

*±.003 [±0.08]; tolerance is not to accumulate within one connector pattern.

Technical Documents (pages 295, 296):

Product Specification
108-25034

Application Specification
114-25026

No. of Positions	Dimensions			Right-Angle Header with Hold Down
	A	B	C	
2	.300 [7.62]	.220 [5.59]	.100 [2.54]	104361-1
3	.400 [10.16]	.320 [8.13]	.200 [5.08]	104361-2
4	.500 [12.70]	.420 [10.67]	.300 [7.62]	104361-3
5	.600 [15.24]	.520 [13.21]	.400 [10.16]	104361-4
6	.700 [17.78]	.620 [15.75]	.500 [12.70]	104361-5
7	.800 [20.32]	.720 [18.29]	.600 [15.24]	104361-6
8	.900 [22.86]	.820 [20.83]	.700 [17.78]	104361-7
9	1.000 [25.40]	.920 [23.37]	.800 [20.32]	104361-8
10	1.100 [27.94]	1.020 [25.91]	.900 [22.86]	104361-9
11	1.200 [30.48]	1.120 [28.44]	1.000 [25.40]	1-104361-0
12	1.300 [33.02]	1.220 [30.99]	1.100 [27.94]	1-104361-1
13	1.400 [35.56]	1.320 [33.53]	1.200 [30.48]	1-104361-2

No. of Positions	Dimensions			Right-Angle Header with Hold Down
	A	B	C	
14	1.500 [38.10]	1.420 [36.07]	1.300 [33.02]	1-104361-3
15	1.600 [40.64]	1.520 [38.61]	1.400 [35.56]	1-104361-4
16	1.700 [43.18]	1.620 [41.15]	1.500 [38.10]	1-104361-5
17	1.800 [45.72]	1.720 [43.69]	1.600 [40.64]	1-104361-6
18	1.900 [48.26]	1.820 [46.23]	1.700 [43.18]	1-104361-7
19	2.000 [50.80]	1.920 [48.77]	1.800 [45.72]	1-104361-8
20	2.100 [53.34]	2.020 [51.31]	1.900 [48.26]	1-104361-9
21	2.200 [55.88]	2.120 [53.85]	2.000 [50.80]	2-104361-0
22	2.300 [58.42]	2.220 [56.39]	2.100 [53.34]	2-104361-1
23	2.400 [60.96]	2.320 [58.93]	2.200 [55.88]	2-104361-2
24	2.500 [63.50]	2.420 [61.47]	2.300 [58.42]	2-104361-3
25	2.600 [66.04]	2.520 [64.01]	2.400 [60.96]	2-104361-4

MTE Headers, Vertical, Polarized/Latching, Surface Mount



Material and Finish:

Housing—High temperature thermoplastic, Color - Black, 94V-0 rated

Posts—Brass, plated as follows:

Plating A—Duplex plated .00030 [.00076] gold on contact area, .000100 [.00254] min. tin-lead on solder area, with entire post underplated .000050 [.00127] nickel.

Plating B—Duplex plated .00015 [.00038] gold on contact area, .000100 [.00254] min. tin-lead on solder area, with entire post underplated .000050 [.00127] nickel.

Plating C—.000100 [.00254] tin lead over .000050 [.00127] nickel on entire contact/post

Recommended PC Board Layout

(Refer to MTE Application Spec. 114-25026 for Stencil Aperture Layout using .006 [0.152] or .008 [0.203] stencil thickness

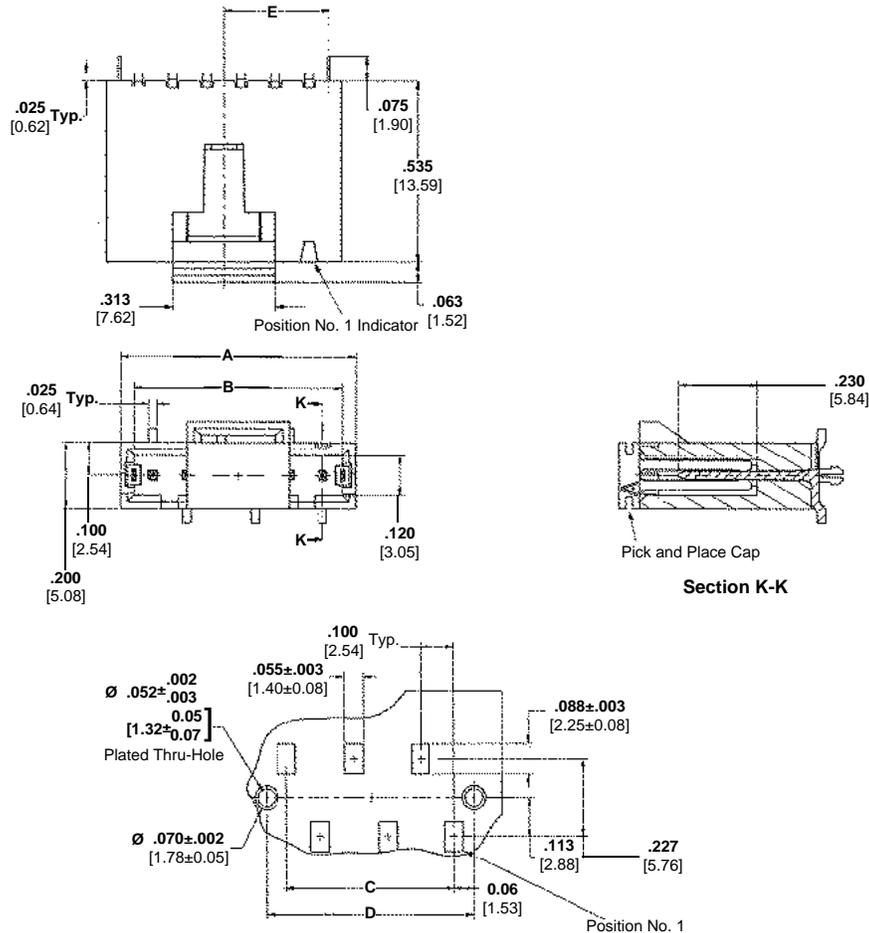

Related Product Data:

Mateable AMPMODU MTE Products:

Receptacle Assemblies (Polarized/Latching)—pages 247, 248

Receptacle Assemblies with Guide Ribs (installed in Single-Row Coupling Shroud)—pages 249, 250, 252, 257

Other Mateable Connectors:

Flexible Film Connectors—Catalog 82007

Technical Documents

(pages 295, 296):

Product Specification
108-25034

Application Specification
114-25026

No. of Pos.	Dimensions					Vertical SMT Headers		
	A	B	C	D	E	Plating A	Plating B	Plating C
2	.300[7.62]	.220[5.59]	.100[2.54]	.220[5.60]	.110[2.80]	1375583-1	1375582-1	1375549-1
3	.400[10.16]	.320[8.13]	.200[5.08]	.320[8.14]	.160[4.07]	1375583-2	1375582-2	1375549-2
4	.500[12.70]	.420[10.67]	.300[7.62]	.420[10.68]	.210[5.34]	1375583-3	1375582-3	1375549-3
5	.600[15.24]	.520[13.21]	.400[10.16]	.520[13.22]	.260[6.61]	1375583-4	1375582-4	1375549-4
6	.700[17.78]	.620[15.75]	.500[12.70]	.620[15.76]	.310[7.88]	1375583-5	1375582-5	1375549-5
7	.800[20.32]	.720[18.29]	.600[15.24]	.720[18.30]	.360[9.15]	1375583-6	1375582-6	1375549-6
8	.900[22.86]	.820[20.83]	.700[17.78]	.820[20.84]	.410[10.42]	1375583-7	1375582-7	1375549-7
9	1.000[25.40]	.920[23.37]	.800[20.32]	.920[23.38]	.460[11.69]	1375583-8	1375582-8	1375549-8
10	1.100[27.94]	1.020[25.91]	.900[22.86]	1.020[25.92]	.510[12.96]	1375583-9	1375582-9	1375549-9
11	1.200[30.48]	1.120[28.45]	1.000[25.40]	1.120[28.46]	.560[14.23]	1-1375583-0	1-1375582-0	1-1375549-0
12	1.300[33.02]	1.220[30.99]	1.100[27.94]	1.220[31.00]	.610[15.50]	1-1375583-1	1-1375582-1	1-1375549-1
13	1.400[35.56]	1.320[33.53]	1.200[30.48]	1.320[33.54]	.660[16.77]	1-1375583-2	1-1375582-2	1-1375549-2
14	1.500[38.10]	1.420[36.07]	1.300[33.02]	1.420[36.08]	.710[18.04]	1-1375583-3	1-1375582-3	1-1375549-3
15	1.600[40.64]	1.520[38.61]	1.400[35.56]	1.520[38.62]	.760[19.31]	1-1375583-4	1-1375582-4	1-1375549-4
16	1.700[43.18]	1.620[41.15]	1.500[38.10]	1.620[41.16]	.810[20.58]	1-1375583-5	1-1375582-5	1-1375549-5
17	1.800[45.72]	1.720[43.69]	1.600[40.64]	1.720[43.70]	.860[21.85]	1-1375583-6	1-1375582-6	1-1375549-6
18	1.900[48.26]	1.820[46.23]	1.700[43.18]	1.820[46.24]	.910[23.12]	1-1375583-7	1-1375582-7	1-1375549-7
19	2.000[50.80]	1.920[48.77]	1.800[45.72]	1.920[48.78]	.960[24.39]	1-1375583-8	1-1375582-8	1-1375549-8
20	2.100[53.34]	2.020[51.31]	1.900[48.26]	2.020[51.32]	1.010[25.66]	1-1375583-9	1-1375582-9	1-1375549-9
21	2.200[55.88]	2.120[53.85]	2.000[50.80]	2.120[53.86]	1.060[26.93]	2-1375583-0	2-1375582-0	2-1375549-0
22	2.300[58.42]	2.220[56.39]	2.100[53.34]	2.220[56.40]	1.110[28.20]	2-1375583-1	2-1375582-1	2-1375549-1
23	2.400[60.96]	2.320[58.93]	2.200[55.88]	2.320[58.94]	1.160[29.47]	2-1375583-2	2-1375582-2	2-1375549-2
24	2.500[63.50]	2.420[61.47]	2.300[58.42]	2.420[61.48]	1.210[30.74]	2-1375583-3	2-1375582-3	2-1375549-3
25	2.600[66.04]	2.520[64.01]	2.400[60.96]	2.520[64.02]	1.260[32.01]	2-1375583-4	2-1375582-4	2-1375549-4

MTE Headers

5

Colored MTE Interconnection System-4 position only

Colored Polarized Latching Receptacle Mates to Colored Vertical Header with PC Board orientation:

Material and Finish:

Housing – Color Thermoplastic, 94V-0 rated

Contact/post – Copper alloy, plated .000100-.000200 [0.00254-0.00508] tin-lead over .000050 [0.00127] nickel on entire contact/post.

Technical Documents (pages 295, 296):

Product Specification
108-25034

Application Specification
114-25026

Refer to pages 247 and 265 for line art and customer drawings for specific dimensions.

Note: The .065+/- .003 [1.65+/-0.08] diameter hole, used for PCB orientation, changes in position for headers listed below.

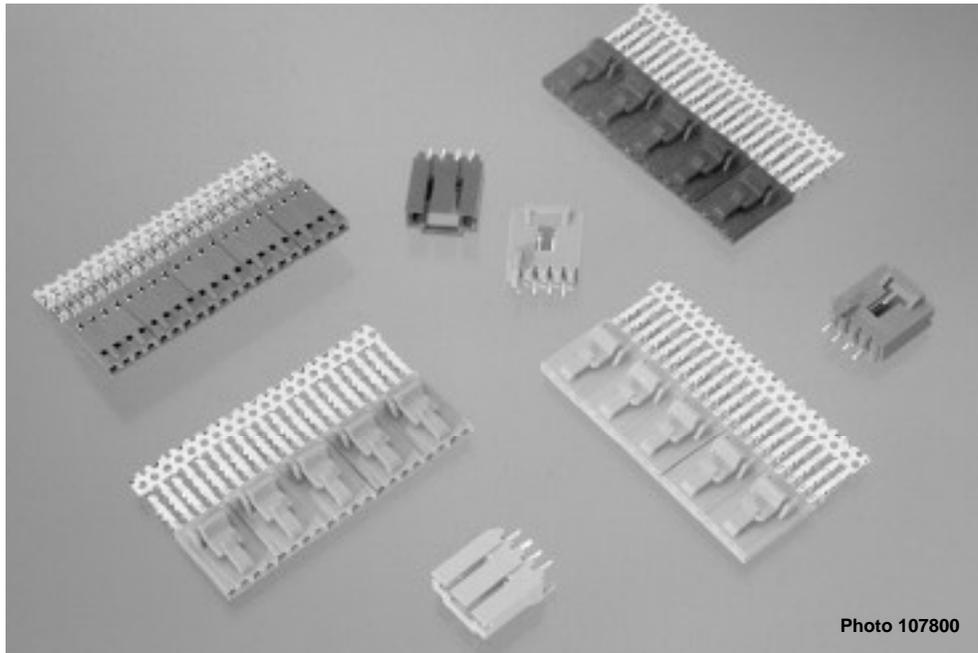
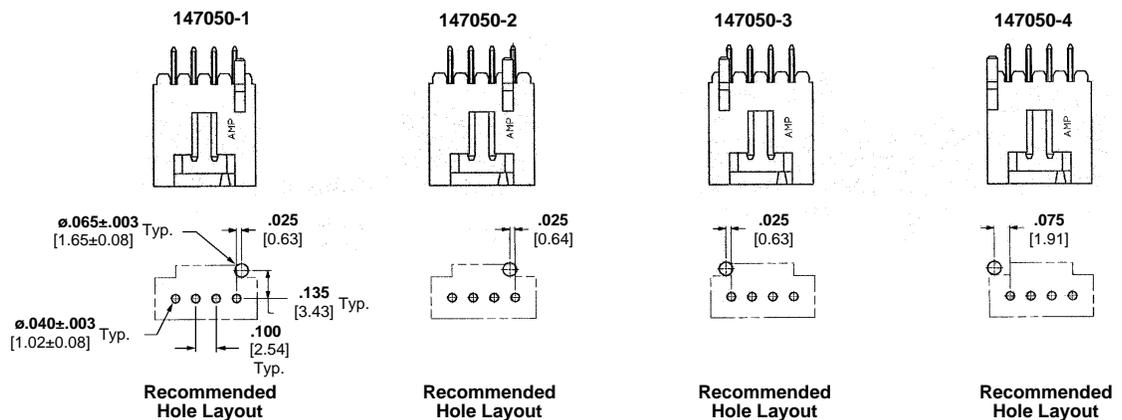

Photo 107800

Color	Strip Form Housing Quantities	Receptacle 30-26 AWG [0.05-0.15mm ²] Wire	Mates with	Header	Unloaded Receptacle Housing
Natural/ Beige	5	147048-1	—	147050-1	147047-1
Green	5	147048-2	—	147050-2	147047-2
Blue	5	147048-3	—	147050-3	147047-3
Yellow	5	147048-4	—	147050-4	147047-4



PC Board Orientation Feature

Colored MTE Interconnection System

5

Interchangeable Contacts, Wire Crimp (Snap-In)

Material and Finish:

Copper alloy C7025, plated as follows:

Plating A—Duplex plated .000030 [0.00076] min. gold on contact area, .000050 [0.00127] min. tin-lead in crimp area, with entire contact underplated .000050 [0.00127] min. nickel

Plating B—Duplex plated .000015 [0.00038] min. gold on contact area, .000050 [0.00127] min. tin-lead in crimp area, with entire contact underplated .000050 [0.00127] min. nickel

Plating C—.000100 [0.00254] min. bright tin-lead over .000050 [0.00127] min. nickel on entire contact



**Keying Plug
Part No. 104072-1**

Ten plugs are supplied per strip. Order quantity reflects the number of strips required.



**Photo 4857
Extraction/Lance Reset
Tool No. 843477-1**

Short Point Receptacles

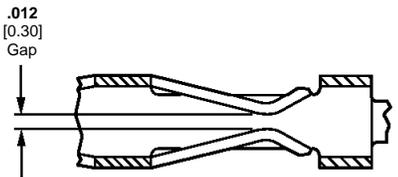
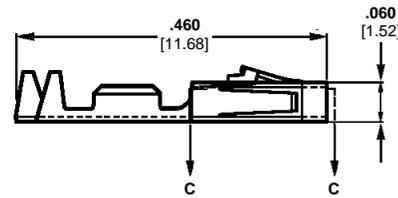
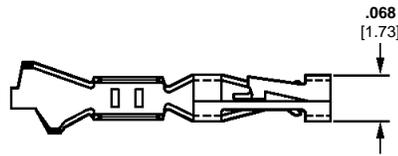

Section C - C

Related Product Data:

Performance Characteristics—page 238

Housings used in—Short Point—pages 240, 241

AMPMODU MTE Unloaded Housings—pages 245-250

Application Tooling—pages 289, 290

Technical Documents (page 295, 296):

Product Specification
108-1472, 108-1472-1

Application Specification
114-25038

Wire Size Range		Ins. Dia. Range	Finish	Contact Part No. (Standard Pressure)		Heavy Duty Miniature Applicator for AMP-O-ELECTRIC Machine*	Applicator for AMP-O-MATIC Stripper/Crimper Machine	Hand Tool Nos.
AWG	[mm ²]			Strip Form	Loose Piece			
32-28	0.03-0.08	.025-.060 0.64-1.52	Plating A	104481-4	104481-8	567296-2	466980-1	91518-1
			Plating B	104481-3	104481-7			
			Plating C	104481-2	104481-6			
26-22	0.13-0.3	.025-.060 0.64-1.52	Plating A	104480-4	104480-9	567297-2	466981-1	91518-1
			Plating B	104480-3	104480-8			
			Plating C	104480-2	104480-7			
24-20	0.2-0.5	.025-.060 0.64-1.52	Plating A	104479-4	104479-7	567298-2	466982-1	91551-1
			Plating B	104479-3	104479-6			
			Plating C	104479-2	104479-5			

*For use with Model "K" machines. Call the Technical Support Center (1-800-522-6752) for part nos. of applicators for use with the Model "G" machines (shown on page 289), as well as other bench machines and fully automatic AMPOMATOR lead making machines.

Note: These wire crimp contacts can be intermixed with insulation displacement crimp contacts.

Interchangeable Contacts, Wire Crimp (Snap-In) (Continued)

Material and Finish:

Phosphor bronze, plated as follows:

Plating A—Duplex plated .000030 [0.00076] gold on contact area, .000030 [0.00076] min. tin-lead in crimp area, with entire contact underplated .000050 [0.00127] nickel

Plating B—Duplex plated .000015 [0.00038] gold on contact area, .000030 [0.00076] min. tin-lead in crimp area, with entire contact underplated .000050 [0.00127] nickel

Plating C—.000100 [0.00254] min. bright tin-lead over .000050 [0.00127] nickel on entire contact

Pins

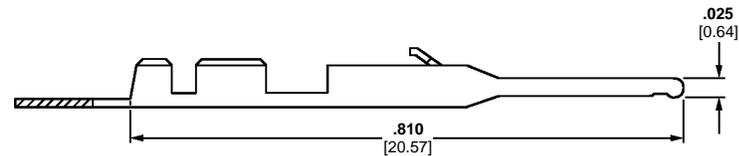
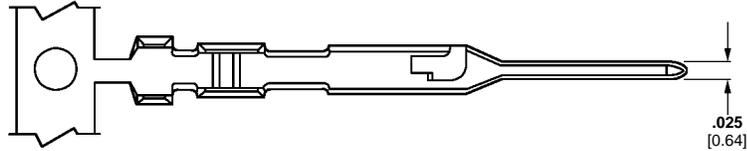

Extraction/Lance Reset
Tool No. 843477-1

Related Product Data:

Performance Characteristics—
page 238

AMPMODU MTE Unloaded Housings—pages 245-250

Application Tooling—
pages 289, 290

Technical Documents (page 295, 296):

Product Specification
108-25034

Application Specification
114-25026

Wire Size Range		Ins. Dia. Range	Finish	Contact Part No. (Standard Pressure)		Heavy Duty Miniature Applicator for AMP-O-LECTRIC Machine*	Applicator for AMP-O-MATIC Stripper/Crimper Machine	Hand Tool Nos.
AWG	[mm ²]			Strip Form	Loose Piece			
32-28	0.03-0.08	.025-.054 0.64-1.37	Plating A	104506-6	104506-7	—	—	58342-2
			Plating B	104506-4	104506-5			
			Plating C	104506-2	104506-3			
26-22	0.14-0.32	.036-.054 0.91-1.37	Plating A	104505-6	104505-7	567239-2	466983-1	91531-1
			Plating B	104505-4	104505-5			
			Plating C	104505-2	104505-3			

*For use with AMP-O-LECTRIC Model "K" machines. Call Technical Support Center (1-800-522-6752) for part nos. of applicators for use with the AMP-O-LECTRIC Model "G" machines (shown on page 289), as well as other bench machines and fully automatic AMPOMATORlead making machines.

Note: These wire crimp contacts can be intermixed with insulation displacement crimp contacts.

MT and Shielded MT Interconnection System

Product Facts

- Full line of mass termination tooling offers lowest installed cost for most production needs
- Dual cantilever beams with anti-overstress features provide redundant contact of mating post and limit beam deflection, preventing permanent deformation
- Redundant insulation displacement slots provide for maximum reliability
- Integral wire strain relief on contact prevents wire motion from being transmitted to wire termination areas
- Built-in contact post stop protects terminated wire from being disturbed by over-insertion of mating post, prevents wire from entering contact area and positively limits mating connector depth
- Insulation displacement contacts and crimp, snap-in contacts are interchangeable
- Complete serviceability with replacement contacts
- Cover styles include low profile (polarized, non-polarized, latching and ejection) and standard profile (hermaphroditic and ejection)
- Connector housings may be stacked end-to-end within one pair of covers. All varieties of covers in this catalog are suitable for multiple housing stacking applications similar to the example illustrated in the photograph to the right
- Recognized under the Component Program of Underwriters Laboratories Inc., File No. E28476
- Certified by Canadian Standards Association, File No. LR 7189

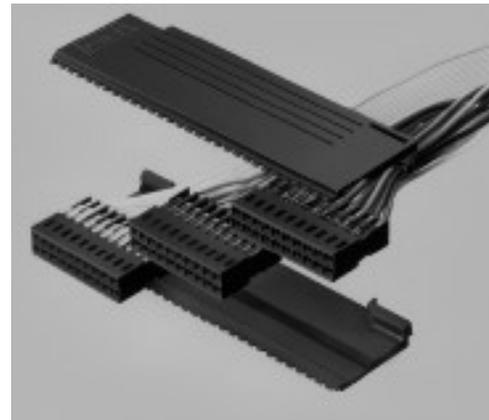

Typical Application of End-to-End Stacking

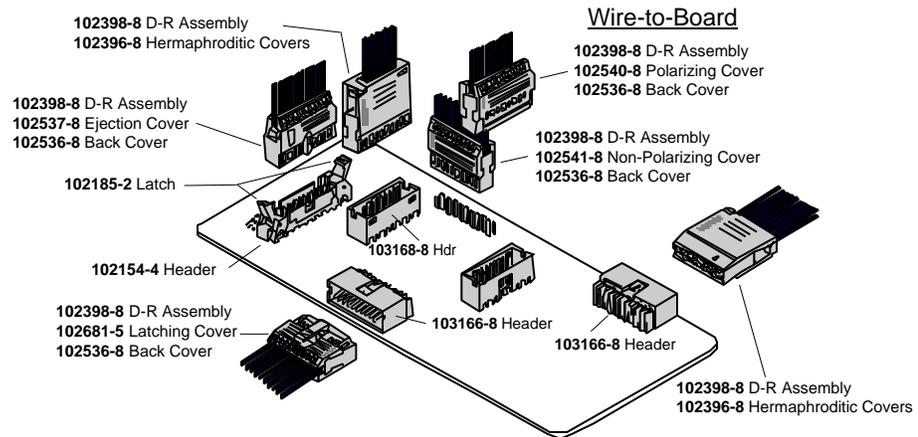

The AMPMODU MT and Shielded MT Interconnection System offers labor and cost savings through mass termination technology, while maintaining the time-proven reliability of the AMPMODU product family. The MT system is comprised of preloaded, double-row receptacle assemblies with snap-on covers and a variety of shielding hardware and accessories. The system is supported by a full line of mass termination tooling to meet virtually most production needs.

The insulation displacement contact, the heart of the MT

system, features a mating interface that is the same as the conventional AMPMODU crimp, snap-in contact, featuring dual cantilever beams, built-in overstress protection and a completely enclosed "box" design.

To reduce EMI/ESD (electromagnetic interference/ electrostatic discharge) at the input-output interface, add-on metal shields can be used to convert standard MT connectors to shielded MT connectors.

Performance Characteristics

Contact Current Rating—3 amperes for single contact in free air. (Amperage could vary due to ambient temperature, wire size and duty cycles.)

Operating Temperature—-65°C to +105°C

Termination Resistance—12 milliohms max.

Max. Mating Force—High pressure - 26 oz. [7.23 N]
Standard pressure - 9 oz. [2.50 N]

Min. Unmating Force—High pressure - 5 oz. [1.39 N]
Standard pressure - 1.5 oz. [0.417 N]

Contact Retention in Housing—5 lb. [22.24 N] per contact min.

**MT Receptacle Assemblies, Double-Row
.100 x .100 [2.54 x 2.54] Centerline**

Housings Pre-loaded with Standard Pressure Contacts



Material and Finish:

Housing—Black thermoplastic, flame retardant

Contacts—Copper alloy, duplex plated .000030 [0.00076] gold on contact area, .000050 [0.00127] min. tin-lead in crimp area, with entire contact underplated .000050 [0.00127] nickel

Related Product Data:

Mateable Connectors—pages 133, 139, 143, 147, 283

Cable Insulation Wall Thickness— .015 [0.39] max.

Cable Insulation Diameter— .050 [1.27] max.

Mating Post Length— 222-.273 [5.64-6.94] max.

Performance Characteristics— page 274

Replacement Contacts—page 284

Connector Covers— pages 277, 278

Application Tooling— pages 290-293

Technical Documents (pages 295, 296):

Product Specification
108-25015, 108-25018, 108-25030

Application Specification
114-25032

Instruction Sheet
408-6532

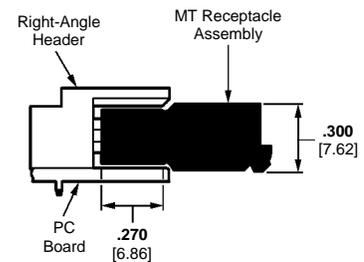
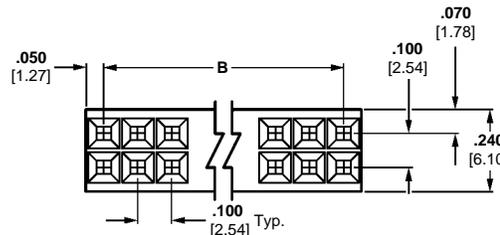
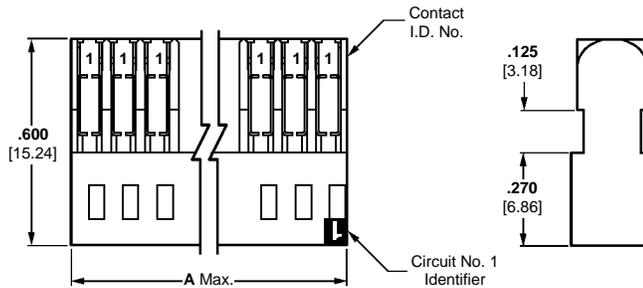

No. of Pos.	Dimensions		Part Nos. (Stamped)			Unloaded Housings
	A	B	Wire Size Range			
			30-26 AWG [0.05-0.15 mm ²]	26-22 AWG [0.12-0.3 mm ²]	22-20 AWG [0.3-0.6 mm ²]	
6	.300 [7.62]	.200 [5.08]	102393-1	102398-1	102448-1	102394-1
8	.400 [10.16]	.300 [7.62]	102393-2	102398-2	102448-2	102394-2
10	.500 [12.70]	.400 [10.16]	102393-3	102398-3	102448-3	102394-3
12	.600 [15.24]	.500 [12.70]	102393-4	102398-4	102448-4	102394-4
14	.700 [17.78]	.600 [15.24]	102393-5	102398-5	102448-5	102394-5
16	.800 [20.32]	.700 [17.78]	102393-6	102398-6	102448-6	102394-6
18	.900 [22.86]	.800 [20.32]	102393-7	102398-7	102448-7	102394-7
20	1.000 [25.40]	.900 [22.86]	102393-8	102398-8	102448-8	102394-8
22	1.100 [27.94]	1.000 [25.40]	102393-9	102398-9	102448-9	102394-9
24	1.200 [30.48]	1.100 [27.94]	1-102393-0	1-102398-0	1-102448-0	1-102394-0
26	1.300 [33.02]	1.200 [30.48]	1-102393-1	1-102398-1	1-102448-1	1-102394-1
28	1.400 [35.56]	1.300 [33.02]	1-102393-2	1-102398-2	1-102448-2	1-102394-2
30	1.500 [38.10]	1.400 [35.56]	1-102393-3	1-102398-3	1-102448-3	1-102394-3
32	1.600 [40.64]	1.500 [38.10]	1-102393-4	1-102398-4	1-102448-4	1-102394-4
34	1.700 [43.18]	1.600 [40.64]	1-102393-5	1-102398-5	1-102448-5	1-102394-5
40	2.000 [50.80]	1.900 [48.26]	1-102393-8	1-102398-8	1-102448-8	1-102394-8
50	2.500 [63.50]	2.400 [60.96]	2-102393-3	2-102398-3	2-102448-3	2-102394-3
60	3.000 [76.20]	2.900 [73.66]	2-102393-8	2-102398-8	2-102448-8	2-102394-8
64	3.200 [81.28]	3.100 [78.74]	3-102393-0	3-102398-0	3-102448-0	3-102394-0

Note: Contact Extraction/Lance Reset Tool No. 843477-3, see page 284.

Keying Plugs

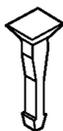

Part No. 86286-1
(Plugs into receptacle contact)



Part No. 87077-2
(Plugs directly into housing)

Material—Natural color nylon

**MT Receptacle Assemblies, Double-Row
.100 x .100 [2.54 x 2.54] Centerline**

Housings Pre-loaded with High Pressure Contacts



Material and Finish:

Housing—Black thermoplastic, flame retardant

Contacts—Copper alloy, duplex plated .000030 [0.00076] gold on contact area, .000050 [0.00127] min. tin-lead in crimp area, with entire contact underplated .000050 [0.00127] nickel

Related Product Data:

Mateable Connectors—pages 133, 139, 143, 147, 283

Cable Insulation Wall Thickness— .015 [0.39] max.

Cable Insulation Diameter— .050 [1.27] max.

Mating Post Length— .200-.273 [5.64-6.94] max.

Performance Characteristics— page 274

Replacement Contacts—page 284

Connector Covers— pages 277, 278

Application Tooling— pages 290-293

Technical Documents (pages 295, 296):

Product Specification
108-25015, 108-25018, 108-25030

Application Specification
114-25032

Instruction Sheet
408-6532

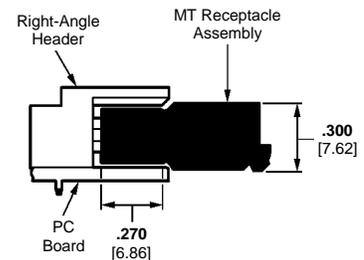
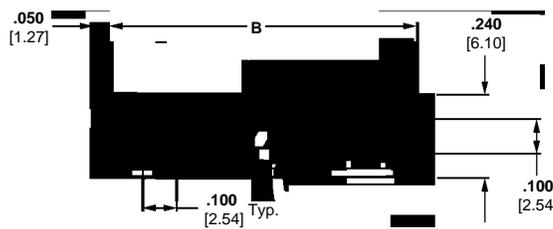
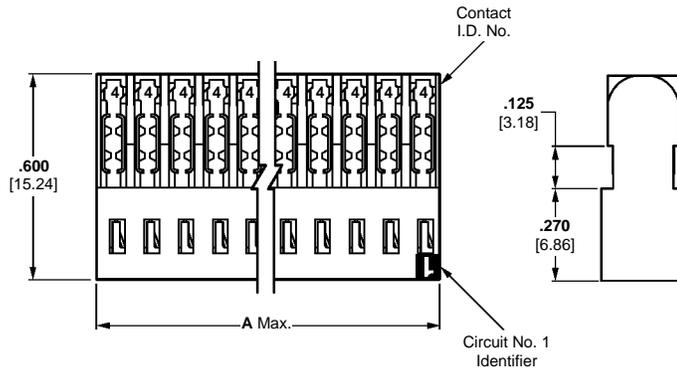

No. of Pos.	Dimensions		Part Nos. (Stamped*)		
	A	B	Wire Size Range		
			30-26 AWG [0.05-0.15 mm ²]	26-22 AWG [0.12-0.3 mm ²]	22-20 AWG [0.3-0.6 mm ²]
6	.300 [7.62]	.200 [5.08]	102693-1	102694-1	102695-1
8	.400 [10.16]	.300 [7.62]	102693-2	102694-2	102695-2
10	.500 [12.70]	.400 [10.16]	102693-3	102694-3	102695-3
12	.600 [15.24]	.500 [12.70]	102693-4	102694-4	102695-4
14	.700 [17.78]	.600 [15.24]	102693-5	102694-5	102695-5
16	.800 [20.32]	.700 [17.78]	102693-6	102694-6	102695-6
18	.900 [22.86]	.800 [20.32]	102693-7	102694-7	102695-7
20	1.000 [25.40]	.900 [22.86]	102693-8	102694-8	102695-8

*Cavity identification — first cavity (one side); Tyco Electronics Part No. and date code stamped on housing where size permits.
Note: Contact Extraction/Lance Reset Tool No. 843477-3, see page 284.

Keying Plugs

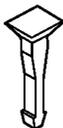

Part No. 86286-1
(Plugs into receptacle contact)



Part No. 87077-2
(Plugs directly into housing)

Material—Natural color nylon

MT Receptacle Assemblies

5

Low Profile Covers for Double-Row MT Receptacle Assemblies

Material:

Black thermoplastic, flame retardant

Related Product Data:

For use on Double-Row MT Receptacle Assemblies—pages 275, 276

Technical Documents (pages 295, 296):

Product Specification
108-25015, 108-25018, 108-25030

Application Specification
114-25032

Instruction Sheet
408-6532

Note: See page 278 for Low Profile Cover Part Nos.

Front Covers

A - Polarizing Cover
(Mates with AMPMODU 4-sided shrouded headers. Refer to pages 133, 139, 143, 147.)

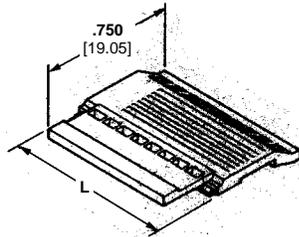

B - Latching Cover
(Mates with AMPMODU 4-sided shrouded headers with extraction slot. Refer to pages 133, 139, 143, 147.)

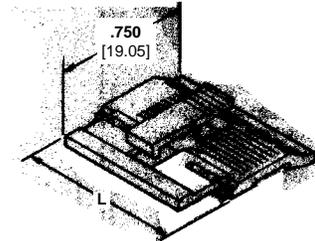

C - Ejection Cover
(Mates with AMP-LATCH universal ejection style pin headers equipped with latching ears, Part No. 102185-2 (with push tabs) or Part No. 102312-2 (without push tabs), see AMP Catalog 82012.)

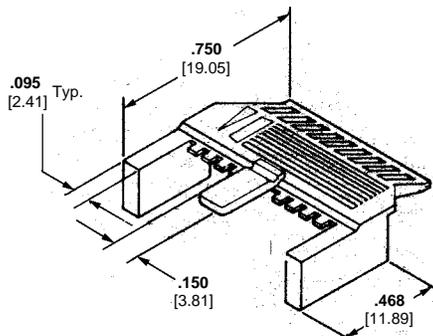

D - Non-Polarizing Cover
(Designed for use with shielded connectors, pages 280 & 281; or for non-polarizing applications.)

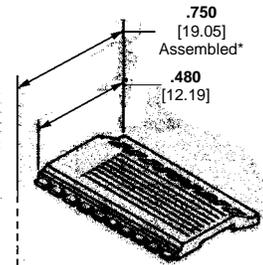

*Dimension applies to cover when installed on connector housing.

Back Covers

E - For Shielding and Non-Shielding Applications
(For use with any low profile cover.)

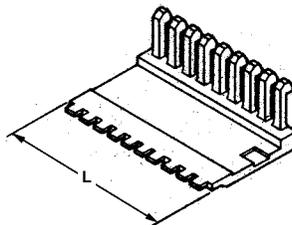

F - For Shielding Applications
(For use with Non-Polarizing Cover only.)

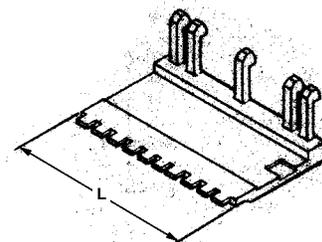

Standard Profile Covers for Double-Row MT Receptacle Assemblies

Material:

Black thermoplastic, flame retardant

Related Product Data:

For use on Double-Row MT Receptacle Assemblies—pages 275, 276

Technical Documents (pages 295, 296):

Product Specification
108-25015, 108-25018, 108-25030

Application Specification
114-25032

Instruction Sheet
408-6532

G - Hermaphroditic Cover

(Two hermaphroditic covers can be used or one hermaphroditic cover can be used with an H Ejection Cover.)

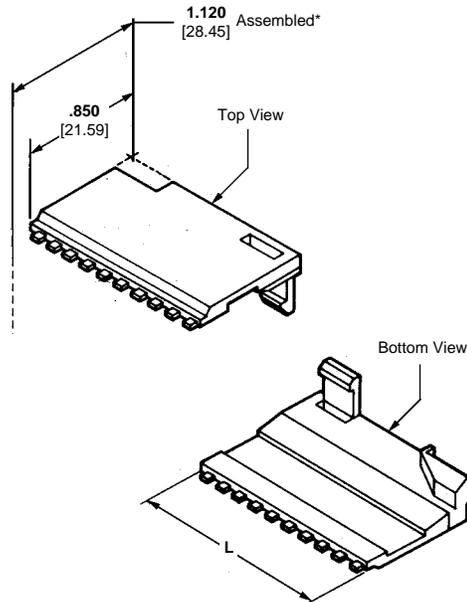

H - Ejection Cover

(Mates with AMP-LATCH universal ejection style pin headers equipped with latching ears, Part No. 102185-2 (with push tabs) or Part No. 102312-2 (without push tabs), see Tyco Electronics Catalog 82012.

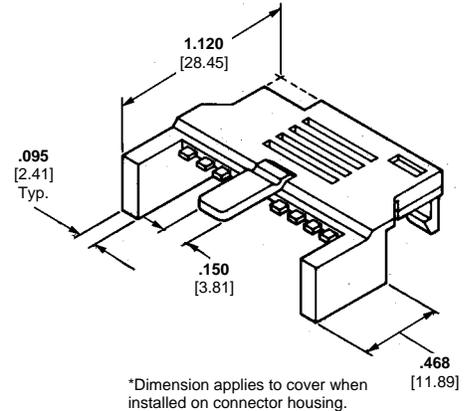

*Dimension applies to cover when installed on connector housing.

No. of Pos.	Dimension L	Low Profile Covers						Standard Profile Covers	
		Front Covers				Back Covers		G Hermaphroditic	H Ejection
		A Polarizing	B Latching	C Ejection	D Non-Polarizing	E Shielding and Non-Shielding Applications	F Shielding Applications		
6	.300 [7.62]	102540-1	—	102537-1	102541-1	102536-1	—	102396-1	—
8	.400 [10.16]	102540-2	—	102537-2	102541-2	102536-2	—	102396-2	—
10	.500 [12.70]	102540-3	—	102537-3	102541-3	102536-3	—	102396-3	—
12	.600 [15.24]	102540-4	102681-1	102537-4	102541-4	102536-4	102823-5	102396-4	—
14	.700 [17.78]	102540-5	102681-2	102537-5	102541-5	102536-5	102823-6	102396-5	—
16	.800 [20.32]	102540-6	102681-3	102537-6	102541-6	102536-6	102823-7	102396-6	—
18	.900 [22.86]	102540-7	102681-4	102537-7	102541-7	102536-7	102823-1	102396-7	—
20	1.000 [25.40]	102540-8	102681-5	102537-8	102541-8	102536-8	102823-4	102396-8	103268-6
22	1.100 [27.94]	102540-9	102681-6	102537-9	102541-9	102536-9	102823-8	102396-9	—
24	1.200 [30.48]	1-102540-0	102681-7	1-102537-0	1-102541-0	1-102536-0	102823-9	1-102396-0	103268-7
26	1.300 [33.02]	1-102540-1	102681-8	1-102537-1	1-102541-1	1-102536-1	1-102823-0	1-102396-1	103268-8
28	1.400 [35.56]	1-102540-2	102681-9	1-102537-2	1-102541-2	1-102536-2	1-102823-1	1-102396-2	—
30	1.500 [38.10]	1-102540-3	1-102681-0	1-102537-3	1-102541-3	1-102536-3	1-102823-2	1-102396-3	103268-9
32	1.600 [40.64]	—	1-102681-1	1-102537-4	1-102541-4	1-102536-4	1-102823-3	1-102396-4	—
34	1.700 [43.18]	—	1-102681-2	1-102537-5	1-102541-5	1-102536-5	1-102823-4	1-102396-5	1-103268-0
40	2.000 [50.80]	—	1-102681-5	1-102537-8	1-102541-8	1-102536-8	102823-2	1-102396-8	—
50	2.500 [63.50]	—	2-102681-0	2-102537-3	2-102541-3	2-102536-3	102823-3	2-102396-3	1-103268-3
60	3.000 [76.20]	—	—	2-102537-8	2-102541-8	2-102536-8	—	2-102396-8	—
64	3.200 [81.28]	—	—	3-102537-0	3-102541-0	3-102536-0	—	3-102396-0	—

MT Standard Profile Covers

5

Shielding Hardware and Accessories for MT Interconnection System

Product Facts

- Add-on shielding accessories for existing AMPMODU Standard MT and PC board mounted headers
- Compact design
- Tin plated copper alloy material
- Redundant cantilever beams provide for good peripheral contact, eliminating the need for a separate RF gasket
- Polarized mating
- 360° cable braid termination with cable jacket support
- Cable shielding hardware permits molded cable terminations after assembly
- Must be used with braided shielded cables
- Solder tabs on right-angle header shields are self-retaining in a PC board



Photo 110928

Shielded MT Receptacles

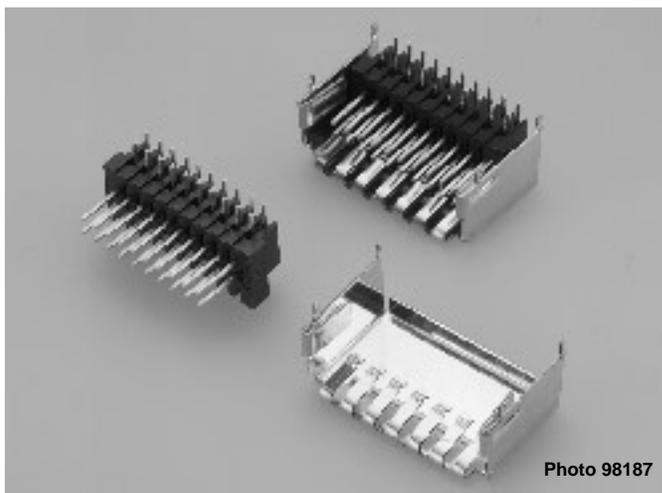

Photo 98187

Shielded Right-Angle Headers

The shielded AMPMODU MT system features add-on metal shielding kits for double-row standard MT receptacle assemblies and double-row right-angle headers.

Cable shielding hardware consists of a ferrule and two stamped and formed shell halves. The inner shell half has a series of integral cantilever beams to provide

good peripheral contact with the mating outer shell half. This feature also eliminates the need for a separate RF gasket. Detents in the cantilever beam provide a positive lock when the two halves are mated. During assembly the inner and outer shell halves are snapped together over a terminated standard MT connector.

Shields for right-angle headers have integral cantilever beams which provide good contact with the mating shielded MT receptacle assembly, without the use of a separate RF gasket.

Shielding Hardware and Accessories for Double-Row MT Receptacle Assemblies

Two-Piece Shields—Straight Exit

Material and Finish:

Shell Halves—Copper alloy, .020 [0.51] thick; pretinned .000030 [0.00076] min.

Related Product Data:

Double-Row MT Receptacle Assemblies—pages 275, 276

Non-Polarizing Covers (Part No. Series 102541 with back cover 102536 or 102823)—pages 277, 278

Shield Ferrules—page 282

Technical Documents (pages 295, 296):

Product Specification
108-25015, 108-25018, 108-25030

Application Specification
114-25032

Instruction Sheet
408-6532

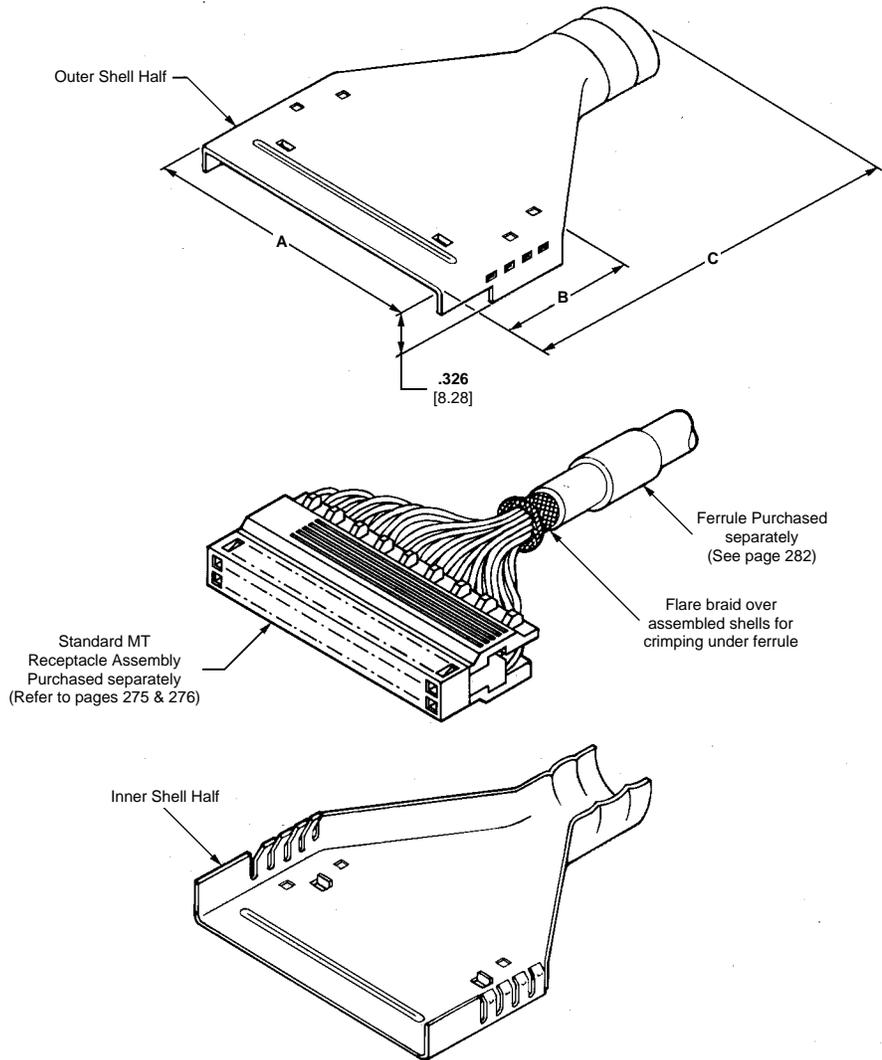

No. of Pos.	Dimensions			Part Nos.	
	A	B	C	Outer Shell	Inner Shell
6	.410 [10.41]	.817 [20.75]	1.268 [32.21]	102988-2	102987-6
10	.610 [15.49]	.817 [20.75]	1.667 [42.34]	103137-2	103136-2
16	.910 [23.11]	.950 [24.13]	1.925 [48.90]	103153-2	103152-2
26	1.410 [35.81]	.950 [24.13]	1.925 [48.90]	103341-2	103340-2
40	2.110 [53.59]	1.325 [33.66]	2.468 [62.69]	104272-1	104271-1
50	2.610 [66.29]	.950 [24.13]	2.468 [62.69]	103158-2	103157-2

Note: Match shield size to number of connector positions.

Shielding Hardware and Accessories for Double-Row MT Receptacle Assemblies (Continued)

Two-Piece Shields—Right-Angle Exit

Material and Finish:

Shell Halves—Copper alloy, .020 [0.51] thick; pretinned .000030 [0.00076] min.

Related Product Data:

Double-Row MT Receptacle Assemblies—pages 275, 276

Non-Polarizing Covers (Part No. Series 102541 with back cover 102536 or 102823)—pages 277, 278

Shield Ferrules—page 282

Technical Documents (pages 295, 296):

Product Specification 108-25015, 108-25018, 108-25030

Application Specification 114-25032

Instruction Sheet 408-6532

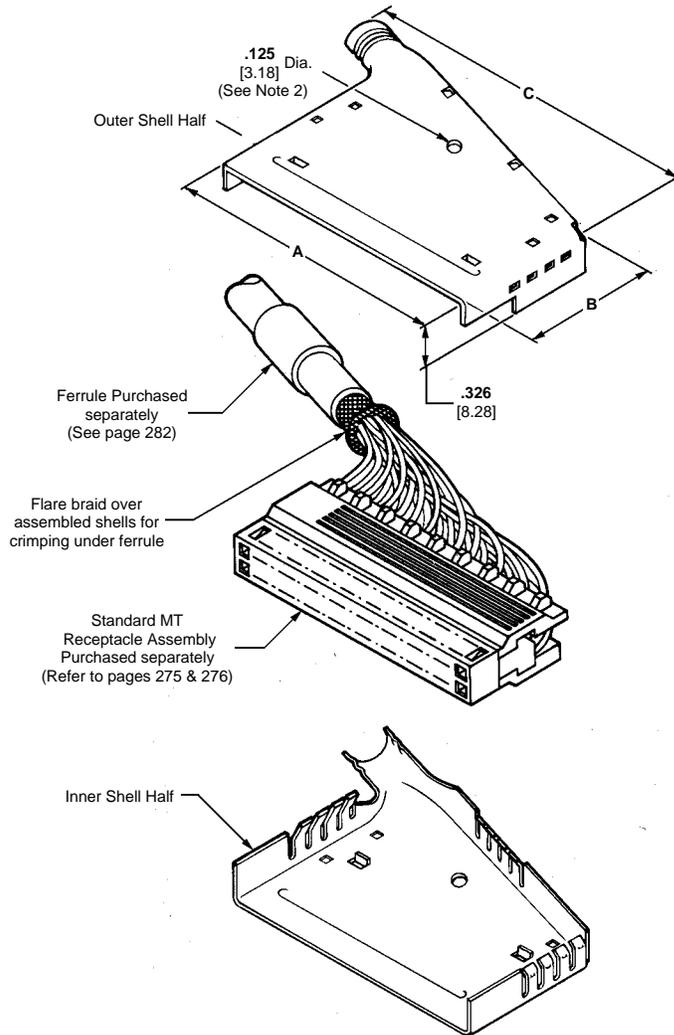

No. of Pos.	Dimensions			Part Nos.	
	A	B	C	Outer Shell	Inner Shell
18	1.010 [25.65]	1.120 [28.45]	1.413 [35.89]	102784-2	102783-2
26	1.410 [35.81]	1.166 [29.62]	1.975 [50.17]	103139-2	103138-2
40	2.110 [53.59]	1.135 [28.83]	2.633 [66.88]	102786-2	102785-2
50	2.610 [66.29]	.983 [24.97]	3.133 [79.58]	102788-2	102787-2
60	3.110 [78.99]	1.118 [28.40]	3.606 [91.59]	103141-2	103140-2

Notes: 1. Match shield size to number of connector positions.
2. Hole is provided in 26 through 60-position cable shields for application of optional cable tie pulling ring after assembly.

Shielding Hardware and Accessories for Double-Row MT Receptacle Assemblies (Continued)

Ferrules for Shielding Kits

Material and Finish:

Soft copper, tin plated

Related Product Data:

Used with Shielding Kits—
pages 280, 281

Technical Documents (pages 295, 296):

Product Specification 108-25015, 108-25018, 108-25030

Application Specification 114-25032

Instruction Sheet 408-6532

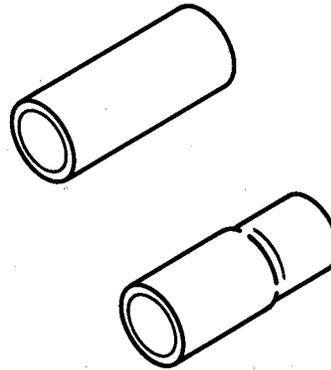

Application Tooling



AMP-O-LECTRIC Model "G" Terminating Machine

AMP Hand Tool 91410-1 (Die Set required, see table below)

No. of Positions	Straight-Exit Shields		Right-Angle Exit Shields		Cable Dia. Range	Ferrule Part Number	Applicator Die* Assembly Part No.	Hand Tool Die Sets	
	Outer	Inner	Outer	Inner				Insulation	Braid
6	102988-2	102987-6	—	—	0.170-0.195 [4.32-4.95]	1-102903-8 ^a	812665-1	1-527116-9	527116-4
					0.200-0.250 [5.08-6.35]	102985-3	812665-2	1-527116-8	527116-4
					0.190-0.240 [4.83-6.10]	1-102903-5	812665-6	1-527116-7	527116-3
10	103137-2	103136-2	—	—	0.250-0.300 [6.35-7.62]	102903-9	812665-5	1-527116-6	527116-3
					0.310-0.360 [7.87-9.14]	102903-3	812665-4	1-527116-5	527116-3
					0.370-0.420 [9.40-10.67]	102789-3	812665-3	1-527116-4	527116-3
					0.190-0.240 [4.83-6.10]	1-102903-5	812665-6	1-527116-7	527116-3
					0.250-0.300 [6.35-7.62]	102903-9	812665-5	1-527116-6	527116-3
16	103153-2	103152-2	—	—	0.310-0.360 [7.87-9.14]	102903-3	812665-4	1-527116-5	527116-3
					0.370-0.420 [9.40-10.67]	102789-3	812665-3	1-527116-4	527116-3
					0.190-0.240 [4.83-6.10]	1-102903-5	812665-6	1-527116-7	527116-3
					0.250-0.300 [6.35-7.62]	102903-9	812665-5	1-527116-6	527116-3
					0.310-0.360 [7.87-9.14]	102903-3	812665-4	1-527116-5	527116-3
18	—	—	102784-2	102783-2	0.370-0.420 [9.40-10.67]	102789-3	812665-3	1-527116-4	527116-3
					0.320-0.370 [8.13-9.40]	2-102903-4	812665-9	1-527116-3	527116-2
					0.380-0.420 [9.65-10.67]	2-102903-1	812665-8	1-527116-2	527116-2
					0.430-0.460 [10.92-11.68]	102789-6	812665-7	1-527116-1	527116-2
					0.320-0.370 [8.13-9.40]	2-102903-4	812665-9	1-527116-3	527116-2
40	104272-1	104271-1	102786-2	102785-2	0.380-0.420 [9.65-10.67]	2-102903-1	812665-8	1-527116-2	527116-2
					0.430-0.460 [10.92-11.68]	102789-6	812665-7	1-527116-1	527116-2
					0.380-0.420 [9.65-10.67]	3-102903-0	1-812665-5	1-527116-2	527116-1
					0.430-0.460 [10.92-11.68]	2-102903-7	1-812665-4	1-527116-1	527116-1
					0.470-0.520 [11.94-13.21]	102789-9	1-812665-3	1-527116-0	527116-1
50	103158-2	103157-2	102788-2	102787-2	0.470-0.520 [11.94-13.21]	3-102903-6	1-812665-8	—	—
					0.500-0.545 [12.70-13.84]	3-102903-3	1-812665-7	—	—
					0.550-0.600 [13.97-15.24]	1-102789-2	1-812665-6	—	—

*For use with Model "K" machines. Call the Tyco Electronics Technical Support Center (1-800-522-6752) for part nos. of applicators for use with the AMP-O-LECTRIC Model "G" machines (also shown on page 289), as well as other bench machines and fully automatic AMPOMATORlead making machines.

- Notes:** 1. Ferrules are used with shielding kits shown on pages 280 & 281, and are purchased separately.
 2. Individual anvils and crimpers also may be purchased separately.
 3. Ferrule Part Number 1-102903-8 also requires Spacer Part Number 527116-9.

5 MT Shielding Hardware and Accessories

Shielded MT Headers for use with Shielded MT Receptacle Assemblies

AMPMODU Right-Angle Headers PC Board Mounted

Material and Finish:

Housing—Black thermoplastic, flame retardant

Posts—Copper alloy, plated .000030 [0.00076] gold over .000050 [0.00127] nickel on entire post

Shield—Copper alloy, .020 [0.51] thick; pretinned .000030 [0.00076] min.

Related Product Data:

Mating Connectors—Double-Row MT Receptacle Assemblies with Shielding Hardware—pages 275-282

Technical Documents (pages 295, 296):

Product Specification 108-25015, 108-25018, 108-25030

Application Specification 114-25032.

Instruction Sheet 408-6532

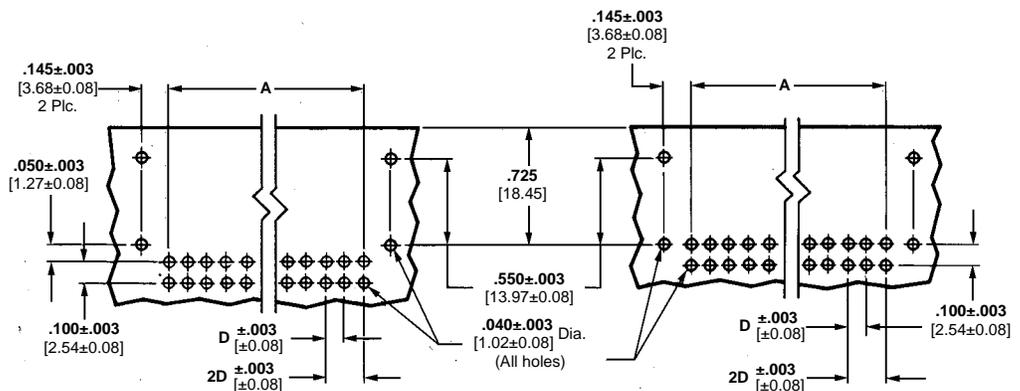
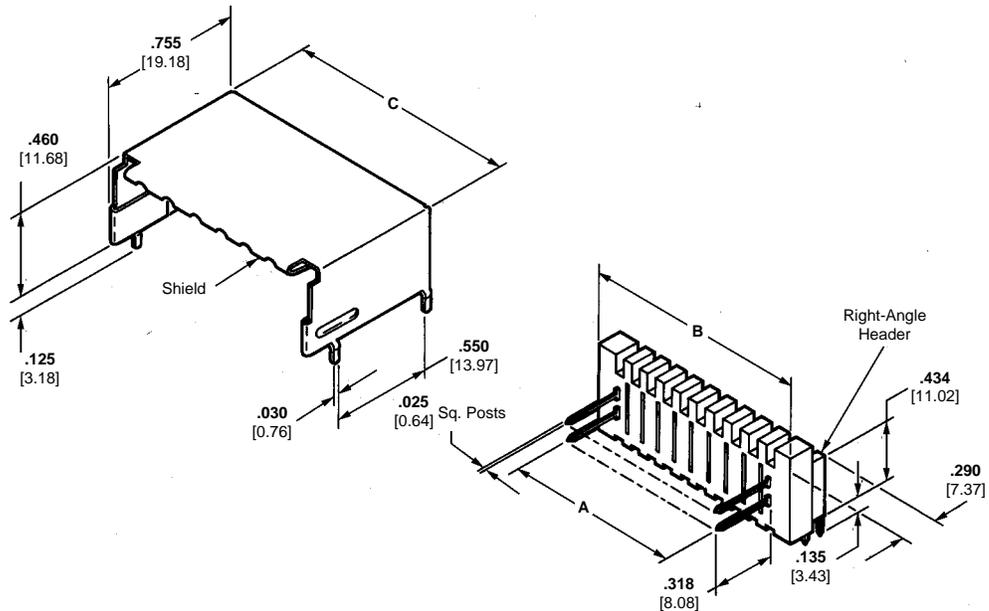

Recommended PC Board Hole Layout for 6, 8 and 10 Positions

Recommended PC Board Hole Layout for 16 thru 50 Positions

D - Contact centerline is .100 [2.54]; ±.003 [0.08] tolerances not to accumulate within one connector pattern.

No. of Pos.	Dimensions			Header Part Nos.	Shield Part Nos.
	A	B	C		
6	.200 [5.08]	.430 [10.92]	.510 [12.95]	102792-6	102991-1
8	.300 [7.62]	.530 [13.46]	.610 [15.49]	102792-8	102991-2
10	.400 [10.16]	.630 [16.00]	.710 [18.03]	102792-1	102791-2
16	.700 [17.78]	.930 [23.62]	1.010 [25.65]	102792-7	102791-3
18	.800 [20.32]	1.030 [26.16]	1.110 [28.19]	102792-2	102791-4
20	.900 [22.86]	1.130 [28.70]	1.210 [30.73]	102792-5	1-102791-0
26	1.200 [30.48]	1.430 [36.32]	1.510 [38.35]	102792-9	102791-1
50	2.400 [60.96]	2.630 [66.80]	2.710 [68.83]	102792-4	102791-8

Replacement MT Receptacle Contacts

Insulation Displacement Contacts

Material and Finish:

Copper alloy, duplex plated .000030 [0.00076] gold on contact area, .000100-.000200 [0.00254-0.00508] tin-lead in crimp area, with entire contact underplated .000050 [0.00127] nickel

Related Product Data:

Performance Characteristics—page 274

Application Tooling—pages 290-293

Technical Documents (pages 295, 296):

Product Specification 108-25015, 108-25018, 108-25030

Application Specification 114-25032

Instruction Sheet 408-6532

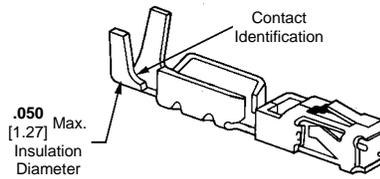

Wire Size Range		Standard Pressure Receptacle		High Pressure Receptacle	
AWG	[mm ²]	Contact Ident.	Part No.	Contact Ident.	Part No.
30-26	0.05-0.15	1	102395-3	4	102641-3
26-22	0.12-0.3	2	102399-3	5	102642-3
22-20	0.3-0.6	3	102449-3	—	—

Note: Termination tooling for MT receptacle insulation displacement contacts is shown on pages 290 thru 293.

MT receptacle contacts incorporate the following features.

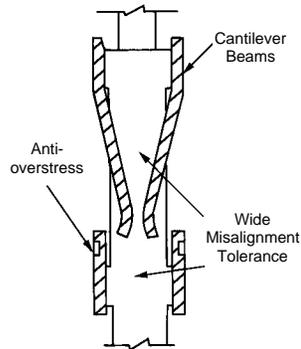

The MT receptacle contact cross-section is primarily rectangular, with rounded corners. Two integral cantilever beams contact the mating square male posts. Deflection of these spring members is limited by anti-overstress and excessive permanent deformation is prevented. This feature allows a wide range for tolerance of misalignment of mating contacts.

The configuration of the receptacle completely encloses the spring members helping to prevent damage during handling and assembly, and makes the system compatible with automatic application techniques.



Extraction/Lance Reset Tool No. 843477-3

AMP Mini-Tandem Spring Receptacle Housings and Contacts

Product Facts

- Individual contacts mate with .025 [0.64] sq. posts, .125 [3.18] long
- Crimp snap-in contacts accept 32-22 AWG [0.03-0.32 mm²] wire
- Retention latch provides for positive installation
- No insertion tool required
- High durability design provides long life
- Available with .000015 [0.00038] or .000030 [0.00076] thick gold inlay in contact areas, or bright tin plated
- Closed-entry housings
- Mini-contact box size: .060 [1.52] sq.
- Mini-Tandem Spring Housings can be stacked on .100 [2.54] centers in either direction
- Mini-Tandem Spring Housings are Recognized under the Component Program of Underwriters Laboratories Inc., File No. E28476
- Certified by Canadian Standards Association, File No. LR 7189

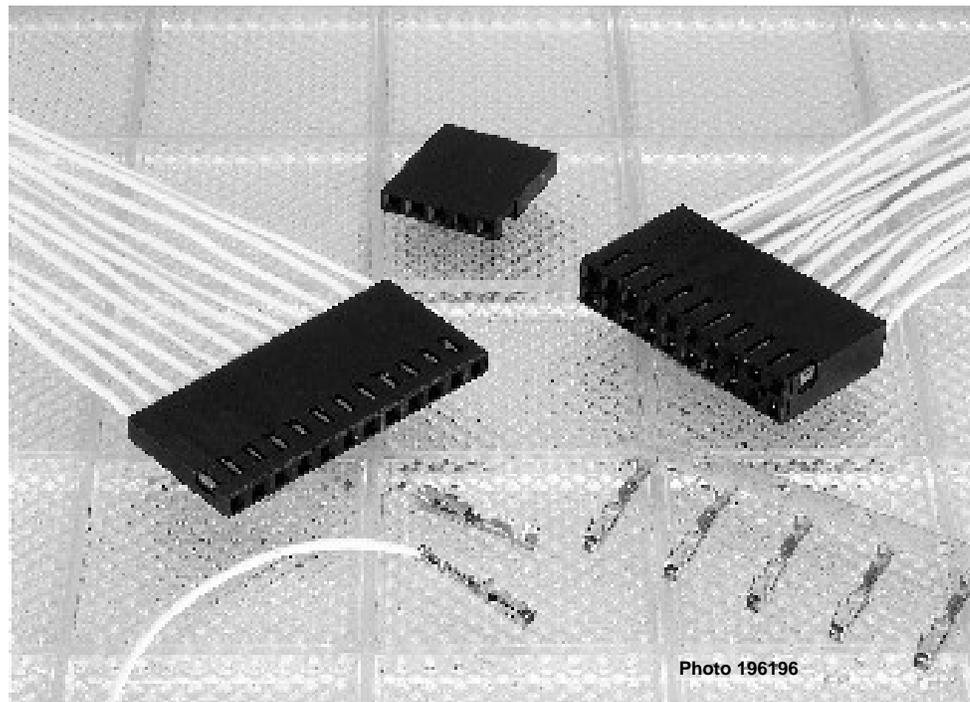

AMP Mini-Tandem Spring Receptacle Contacts are designed to mate with .025 [0.64] posts. When used individually, they will mate with posts as short as .125 [3.18] and when used in a housing, they will mate with .140 [3.55] long posts. These versatile contacts may be used for interconnecting posted pc panels, I/O wiring and cross-connecting pin arrays.

The receptacle contact's box configuration provides for long contact life with controlled contact mating forces which minimize wear. An external retention spring facilitates quick assembly and provides firm seating in a contact housing.

AMP Mini-Tandem Spring Receptacle Contacts are used in single- or double-row housings with .100 [2.54] centerline spacing. Single-row housings can be converted into double-row connectors on .100 x .200 [2.54 x 5.08] centers with the use of stacking clips.

Mini-Tandem Spring Housings can be stacked side-by-side or end-to-end on .100 [2.54] centers.

Specifications

Contact Current Rating—3 amperes

Termination Resistance—
12 milliohms (max.)—gold plated contacts
18 milliohms (max.)—tin plated contacts

Durability—Ref. AMP Product Specification 108-25031

AMP Mini-Tandem Spring Housings, Single-Row

.100 [2.54] Centerline



Material—Black glass-filled polyester, 94V-0 rated

Technical Documents (page 295):

Product Specification 108-25031

Application Specification 114-25021

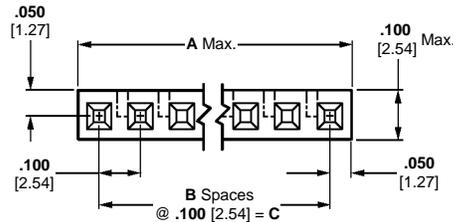
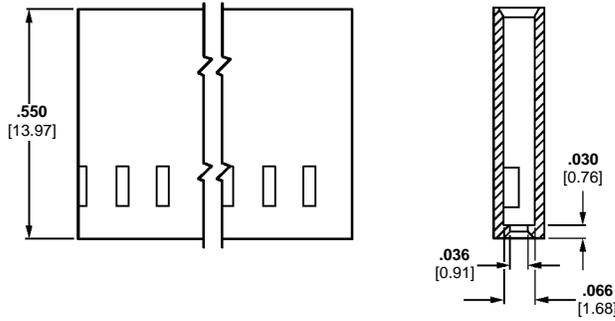

Minimum mating post length is .140 [3.55].

No. of Pos.	Dimensions			Housing Part No.
	A	B	C	
2	.200 [5.08]	1	.100 [2.54]	530554-1
3	.300 [7.62]	2	.200 [5.08]	530554-2
4	.400 [10.16]	3	.300 [7.62]	530554-3
5	.500 [12.70]	4	.400 [10.16]	530554-4
7	.700 [17.78]	6	.600 [15.24]	530554-6
8	.800 [20.32]	7	.700 [17.78]	530554-7
10	1.000 [25.40]	9	.900 [22.86]	530554-9
12	1.200 [30.48]	11	1.100 [27.94]	1-530554-1
16	1.600 [40.64]	15	1.500 [38.10]	1-530554-5
18	1.800 [45.72]	17	1.700 [43.18]	1-530554-7
20	2.000 [50.80]	19	1.900 [48.26]	1-530554-9
22	2.200 [55.88]	21	2.100 [53.34]	2-530554-1

Note: AMP Mini-Tandem Spring contacts for use in these housings are shown on page 288.

Material—Natural color nylon, 94V-2 rated

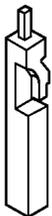

Keying Plug
Part No. 531226-1
(Plugs directly into housing)

AMP Mini-Tandem Spring Housings, Double-Row

.100 [2.54] Centerline

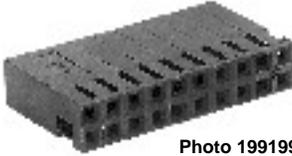

Photo 199199

Material—Black glass-filled polyester, 94V-0 rated*

Technical Documents (page 294):

Product Specification 108-25031

Application Specification 114-25021

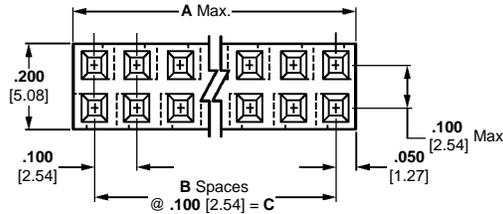
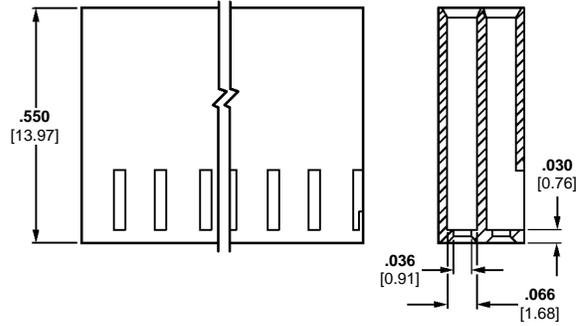

Minimum mating post length is .140 [3.55].

Material—Natural color nylon, 94V-2 rated

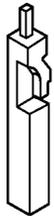

Keying Plug
Part No. 531226-1
(Plugs directly into housing)

No. of Pos.	Dimensions			Housing Part No.
	A	B	C	
4	.200 [5.08]	1	.100 [2.54]	530902-5
6	.300 [7.62]	2	.200 [5.08]	530902-1
8	.400 [10.16]	3	.300 [7.62]	530902-6
10	.500 [12.70]	4	.400 [10.16]	530902-2
12	.600 [15.24]	5	.500 [12.70]	2-530902-0
16	.800 [20.32]	7	.700 [17.78]	3-530902-0
20	1.000 [25.40]	9	.900 [22.86]	530902-8

Note: AMP Mini-Tandem Spring contacts for use in these housings are shown on page 288.

*Consult Tyco Electronics for specific UL recognition.

AMP Mini-Tandem Spring Contacts

Receptacle Contacts

Material and Finish:

Phosphor bronze, plated as follows:

Plating A—Duplex plated .000030 [0.00076] gold inlay on contact area, tin in crimp area, with entire contact underplated .000050 [0.00127] nickel

Plating B—Duplex plated .000015 [0.00038] gold inlay on contact area, tin in crimp area, with entire contact underplated .000050 [0.00127] nickel

Plating C—.000100 [0.00254] min. bright tin over .000030 [0.00076] nickel on entire contact

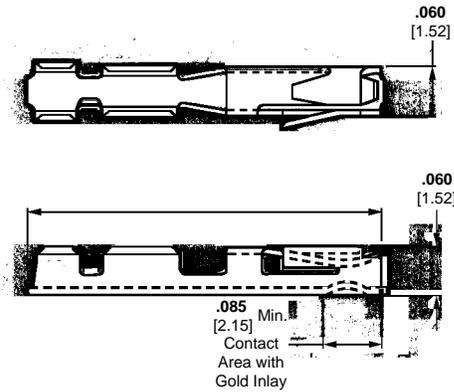

Technical Documents (page 294):

Product Specification 108-25031

Application Specification
114-25021

Low Pressure Contacts

Wire Size Range		Ins. Dia. Range	Finish	Contact Part No.		Miniature Applicator for AMP-O-LECTRIC Machine*	Applicator for AMP-O-MATIC Stripper/Crimper Machine
AWG	mm ²			Strip Form	Loose Piece		
26-22	0.14-0.32	.036-.054 [0.64-1.37]	Plating A	531216-3	531216-4	466819-2	466943-1
			Plating B	531216-1	531216-2		

Standard Pressure Contacts

Wire Size Range		Ins. Dia. Range	Finish	Contact Part No.		Miniature Applicator for AMP-O-LECTRIC Machine*	Applicator for AMP-O-MATIC Stripper/Crimper Machine
AWG	mm ²			Strip Form	Loose Piece		
32-28	0.03-0.08	.025-.054 [0.64-1.37]	Plating B	530901-2	530901-3	466723-1	466952-1
			Plating C	530901-6	530901-7		
			Plating D	530901-4	530901-5		
26-22	0.14-0.32	.036-.054 [0.91-1.37]	Plating B	530553-4	530553-5	466819-2	466943-1
			Plating C	530553-6	530553-7		
			Plating D	530553-2	—		

High Pressure Contacts

Wire Size Range		Ins. Dia. Range	Finish	Contact Part Number		Miniature Applicator for AMP-O-LECTRIC Machine*	Applicator for AMP-O-MATIC Stripper/Crimper Machine
AWG	mm ²			Strip Form	Loose Piece		
32-28	0.03-0.08	.025-.054 [0.64-1.37]	Plating B	531225-6	—	466723-1	466952-1
26-22	0.14-0.32	.036-.054 [0.91-1.37]	Plating B	531224-6	531224-7	466819-2	466943-1

*For use with AMP-O-LECTRIC Model "K" machines. Call the Tooling/Technical Assistance Center (1-800-522-6752) for part nos. of applicators for use with the AMP-O-LECTRIC Model "G" machines (shown on page 289), as well as other bench machines and fully automatic AMPOMATOR lead making machines.

- Notes: 1. Mini-Tandem Spring Receptacle Contacts are for use only in the housings shown on pages 286 & 287. They cannot be used in AMPMODU Mod IV Housings.
2. Use Hand Tool No. 91540-1 for crimping loose-piece receptacles to all wire sizes listed above.
3. Application tooling is described on pages 289 & 293.