

AMPMODU Headers and Receptacles, .100 [2.54] Centerline

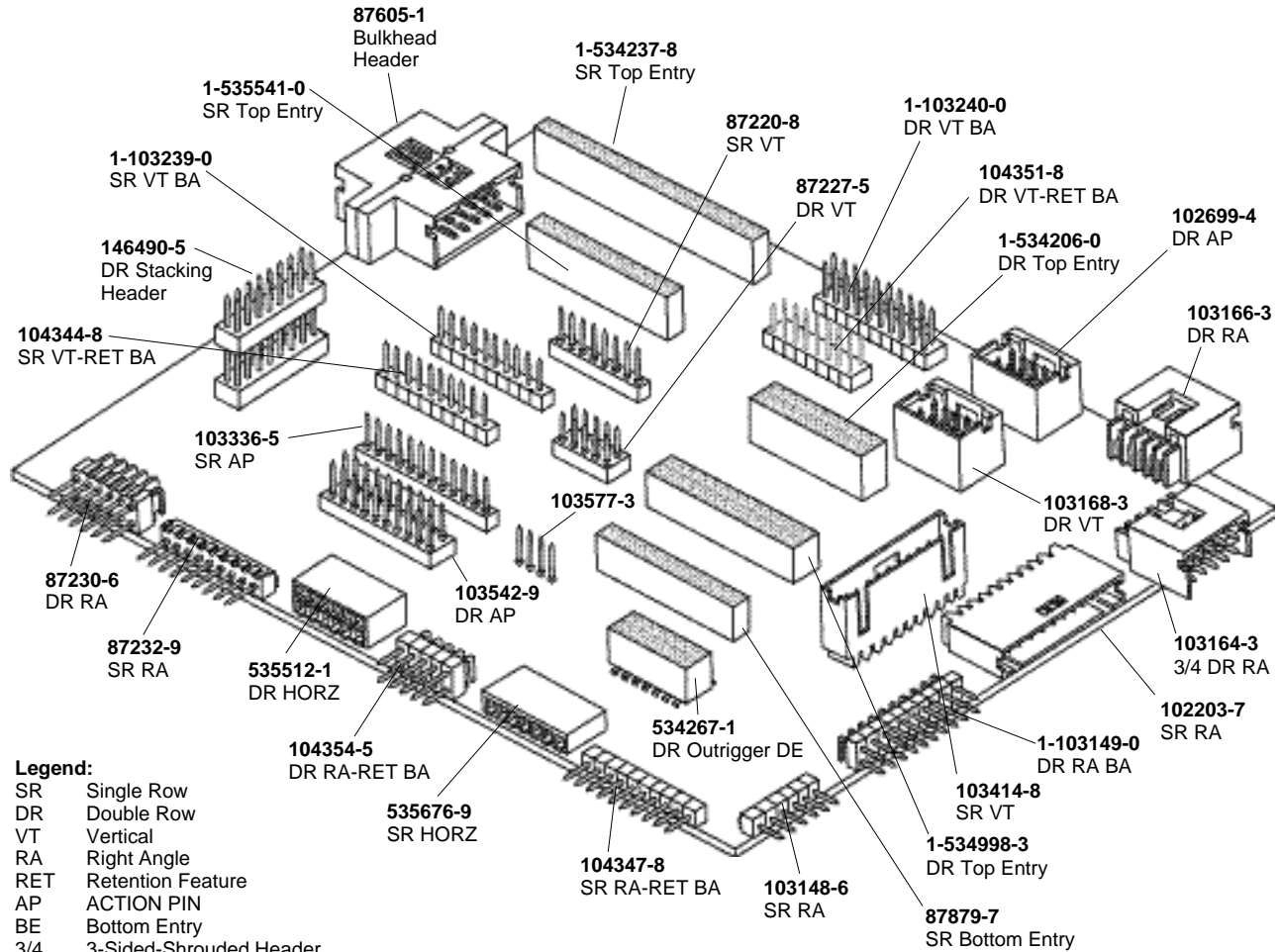

Legend:

- SR Single Row
- DR Double Row
- VT Vertical
- RA Right Angle
- RET Retention Feature
- AP ACTION PIN
- BE Bottom Entry
- 3/4 3-Sided-Shrouded Header
- BA Breakaway
- TR Triple Row
- SMT Surface Mount
- HORZ Horizontal
- DE Dual Entry

For drawings, technical data or samples, contact your Tyco Electronics sales engineer or call the Tyco Electronics Product Information Center: 1-800-522-6752

5
 AMPMODU
 Interconnection System

AMPMODU Headers and Receptacles, .100 [2.54] Centerline

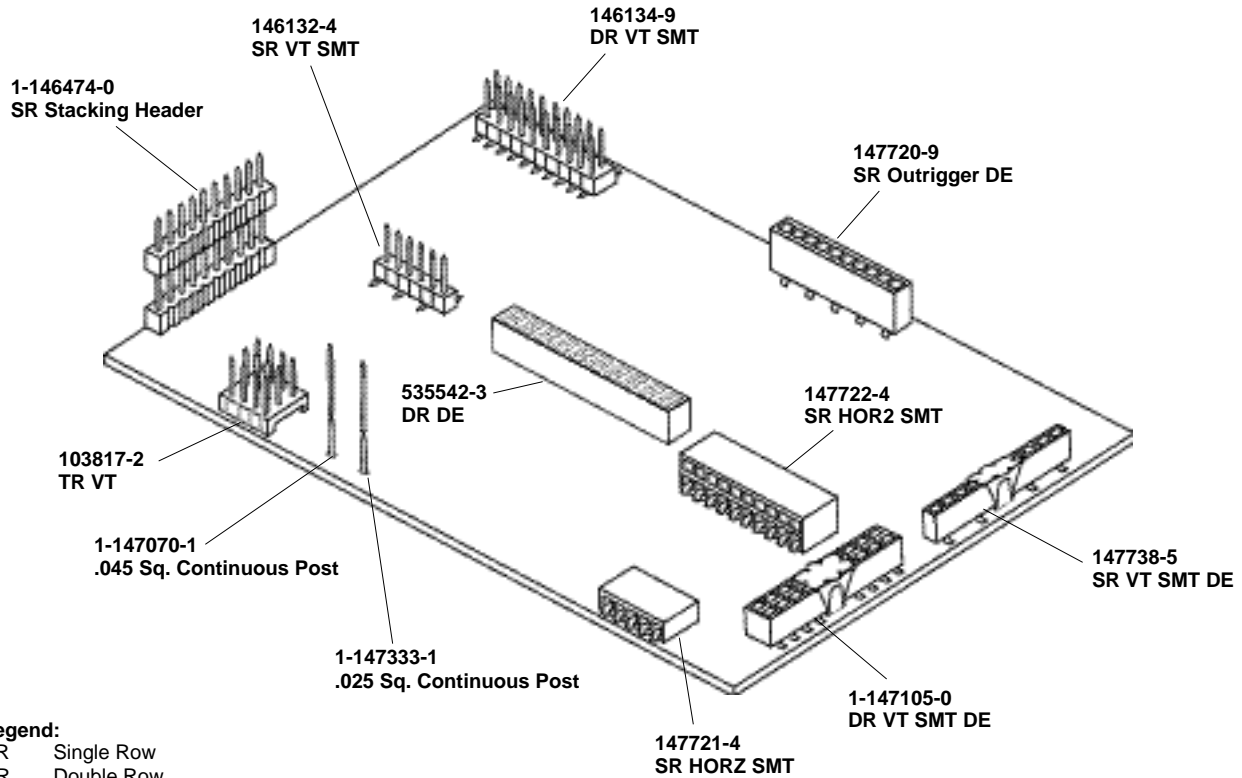

Legend:

- SR Single Row
- DR Double Row
- VT Vertical
- RA Right Angle
- RET Retention Feature
- AP ACTION PIN
- BE Bottom Entry
- 3/4 3-Sided-Shrouded Header
- BA Breakaway
- TR Triple Row
- SMT Surface Mount
- HORZ Horizontal
- DE Dual Entry

For drawings, technical data or samples, contact your Tyco Electronics sales engineer or call the Tyco Electronics Product Information Center: 1-800-522-6752

AMPMODU .025 [0.64] Square Interconnection System

The AMPMODU interconnection system provides interconnections with a unique modular concept, utilizing precision formed receptacle contacts and mating posts.

Mating of the post and receptacle contacts of this system is very tolerant. This is made possible by a post with a burr-free lead-in and a receptacle contact featuring double cantilever beams and anti-overstress stops.

AMPMODU receptacle contacts and posts categorically fall into three general classifications of products, which include: board mounted posts and receptacle assemblies, post headers and wire-applied contact housings for crimp snap-in pin and receptacle contacts.

Board mounted receptacle assemblies are available in various geometries, offering packaging interconnections that include perpendicular, parallel and stacking capabilities.

Crimp snap-in pins for 26-22 AWG [0.12-0.4 mm²] wire and crimp snap-in receptacles for 32-20 AWG [0.03-0.6 mm²] wire provide excellent discrete wire terminations. Housings for these contacts provide ease of handling terminations in high density applications.

Machine applied terminations, through matched application equipment, are geared for virtually any production volume requirement, for the lowest possible applied cost.

AMPMODU mating posts are supplied typically as headers. They are available in various populations to meet the interconnection and packaging requirements of most systems. However, in instances where packaging configurations do not lend themselves to the economies of headers, Tyco Electronics can provide application equipment for the discrete location of individual posts.

Looking at the electronic industry's standard "levels of packaging," the AMPMODU .025 [0.64] square interconnection system is primarily used in levels three and four.

In level three it is used as a connection between two or more printed circuits. A mother/daughter board connection is typical. In

level four it is used as a connection between two subassemblies, such as a power supply and an associated subassembly.

It is also important to note this product can serve as an interconnection in more than one level, depending on the application.

The .025 [0.64] square interconnection system offers the most complete line of post/receptacle packaging products available today. This system, rated at 3 amperes per contact, has been used by almost every industry and marketplace over the last decade and is one of the oldest, most versatile and reliable interconnection systems employing .025 [0.64] square packaging technology.

Terms Explained

Receptacle Contacts

The AMPMODU receptacle cross-section is primarily rectangular, with rounded corners. Two integral cantilever beams contact the mating square or round male posts. Deflection of these spring members is limited by anti-overstress stops, and excessive permanent deformation is prevented. This feature allows a wide range for tolerance of misalignment of mating contacts.

The configuration of the receptacle completely encloses the spring members

preventing damage during handling and assembly and makes the system compatible with automatic application techniques.

Note: Application of a contact lubricant is part of the manufacturing process of all AMPMODU tin-plated crimp products. However, it is not part of the manufacturing process of products that customers will solder, then clean. For these products, Tyco Electronics recommends that customers use contact lubricant. See the Tyco Electronics web page for further information.

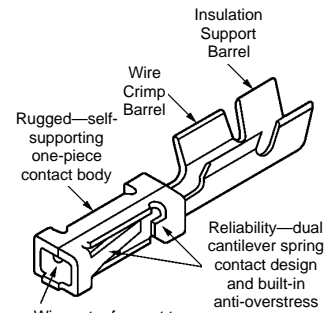

Offers standard, intermediate and high pressure contact forces

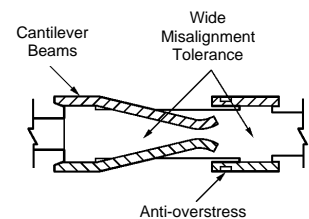

Receptacle-Closed Entry Housing Design

The closed entry housing style better eliminates the chance of a mating post stubbing on the edges of the receptacle contact.

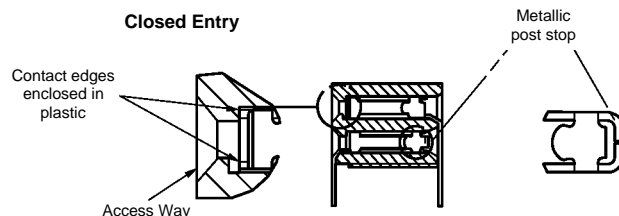
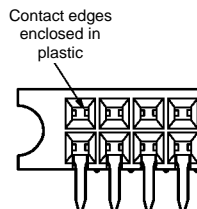

Wire-to-Board, .100 [2.54] Centerline Products

Wire Sizes

Wire Size		Product Family
AWG	[mm ²]	
20	0.5-0.6	Locking Clip, Mod. IV, IV.v, V, MT, Short Point
22-30	0.3-0.05	Locking Clip, Mod. IV, IV.v, V, MTE, MT, Short Point
32	0.03	Mod. IV, IV.v, V, Short Point

Contact Platings

Platings	Product Family
.000015 [0.00038] Gold	Mod. IV, IV.v, V, MTE, MT, Short Point
.000030 [0.00076] Gold	Locking Clip, Mod. IV, IV.v, V, MTE, MT, Short Point
.000050 [0.00127] Gold	Locking Clip, Mod. IV, IV.v, V, MT
Tin	Locking Clip, Mod. IV, IV.v, V, MTE, MT, Short Point

Mating Post Lengths

Post Lengths	Product Family
.210-.283 [5.33-7.19]	Mod. IV(.600 [15.24] Profile Height)
.205-.283 [5.21-7.19]	Mod. IV.v (.600 [15.24] Profile Height)
.185-.283 [4.70-7.19]	Mod. V(.600 [15.24] Profile Height)
.256-.323 [6.50-8.20]	Mod. IV(.645 [16.38] Profile Height)
.251-.323 [6.38-8.20]	Mod. IV.v (.645 [16.38] Profile Height)
.231-.323 [5.87-8.20]	Mod. V(.645 [16.38] Profile Height)
.146-.283 [3.71-7.19]	Tandem Spring (.600 [15.24] Profile Height)
.273-.350 [6.93-8.89]	Tandem Spring (.645 [16.38] Profile Height)
.222-.273 [5.64-6.93]	MT Assembly with Standard Pressure Contacts
.200-.273 [5.08-6.93]	MT Assembly with High Pressure Contacts
.200-.250 [5.08-6.35]	MTE Assembly
.169-.259 [4.29-6.58]	Short Point Connector Assembly
.273-.350 [6.93-8.89]	Locking Clip (Connector Assembly)
.200-.277 [5.08-7.04]	Locking Clip (Single Contact)

Application Tooling

Application Tooling Description	Product Family					
	Mod. IV, IV.v, V	MT	Locking Clip	MTE	Short Point	Level V
Manual Hand Tools (Wire Crimp)	•		•	•	•	
Manual Hand Tools (IDC)		•		•		•
AMP-O-MATIC Stripper/Crimper Machines with Applicator	•		•		•	
CHAMPOMATOR Model 2.5 Machine		•				•
CHAMPOMATOR Model 3A Machine		•				
AMP-O-LECTRIC Machines with Applicator	•		•		•	
Pneumatic Hand Tools	•	•	•	•	•	•
IDC Electric Power Unit				•		
Tube-Fed Ribbon Cable Machine				•		
AMPOMATOR CLS Machines	•		•		•	
Discrete Wire Machine		•				•
Manual Arbor Tool		•				•
Pneumatic Arbor Tool		•				•

Board-to-Board Solutions Guide, .100 [2.54] Centerline Products

Problem or Concern	Tyco Electronics Solution	Single-Row Vertical Headers and Receptacles (Page Ref.)	Single-Row Right-Angle Headers, Horizontal Receptacles (Page Ref.)	Double-Row Vertical Headers and Receptacles (Page Ref.)	Double-Row Right-Angle Headers, Horizontal Receptacles (Page Ref.)
Headers Float Off Board Soldering Operation	HEADERS Retention Feature: Unshrouded Shrouded	109, 110, 118, 119 —	111,112,119 —	113,215 121,216	114,216 122,217
Header Contacts Damaged During Manufacturing Operation or In-Field Use	Shrouded HEADERS : Standard Profile	129,130	131	133-138	139-145
Board/Backplane Requires High Temperature Surface-Mount Compatibility	Press-Fit ACTION PIN POST				
	HEADERS After Reflow: Unshrouded Shrouded	163 —	— —	164 216,165,166	— —
	Machine Applied Posts	180			
	Surface-Mount Compatible Through-Hole:				
	HEADERS : Unshrouded Shrouded (Low Profile)	118* —	119* —	120* 147; 154*	121* 155*
	RECEPTACLES	—	—	213*	211; 212*
	Surface-Mount:				
	HEADERS RECEPTACLES	123* 204-205	— 189	124 206-209	— 190
Application Requires Board Guidance, Polarization and/or Blind-Mate Capability	Two-Piece Family: w/Guide Posts: HEADERS RECEPTACLES	— —	— —	215,216 213*	217 212*
Reduction in Parallel Board-to-Board Stack Height Necessary (Refer to Parallel Stack Guide on Page 64.)	Mod IV Low Profile RECEPTACLES : TOPENTRY :				
	Through-Hole	195	—	196,197*	—
	Surface-Mount	—	—	—	—
	BOTTOMENTRY : Through-Hole Surface-Mount	194 —	— —	— —	— —
	DUAL ENTRY Through-Hole Surface Mount	198 204-205	— —	199-201 206-209	— —
	RECEPTACLES : Bottom Entry Outtrigger (Separate Holes for Receptacle Leads and Mating Leads)	198	—	199	—
Soldering Problems with Through-Hole Bottom Entry Receptacles (Must Mask Post Holes in Board During Soldering Operation)					
Application Requires Connectors to be End-to-End Stackable on .100 [2.54] Grid	End-to-End Stackable:				
	HEADERS (Unshrouded): Through-Hole	92,101,102,109,110	93,94,103,104,111,112	95,96,105,106,113	97,98,107,108,114
	Through-Hole*	118*	119*	120*	122*
	Surface-Mount	123*	—	124*	—
	RECEPTACLES : Through-Hole Surface Mount	192,194,195,198 205	186* 189	193,196,197*,199*,200,201 208-209	187 190

*High temperature compatible version, refer to page ref. listed.

Wire-to-Board Solutions Guide, .100 [2.54] Centerline Products

Customer Requirement	Tyco Electronics Solution	Catalog Page(s)
Application Requires Guidance, Polarization	Mod IV Polarized Housing	237
	MTE Latched Receptacle and Header	247,248,261-268
	MT with Polarizing Covers	275-277
	Short Point Polarized Housing	261
Wire-to-Wire Application	Mod IV Receptacle Contacts and Pins	228-230
Wire-to-Wire Application (Latched)	MTE Latched Receptacle and Shrouded Pin Assembly	247,248,253,254
Wire-to-Wire Application (Through Panel)	MTE Panel Mount	259
High Vibration and Shock Applications	Locking Clip Contacts and Housings	224-226
Printed Circuit Board Polarization	MTE Header with PC Board Orientation Peg	265, 266
	MTE Surface Mount Headers	264,270
Board Requires Surface Mount Capability	MTE High Temperature Compatible Headers	266-268
Need to mate to AMP-LATCH Eject Headers	Mod IV Ejection Housing	237
Need to Minimize Strain to Cable	MT with Eject Covers	275-277
	Mod IV Housing with Strain Relief	235
Application Requires Self-Retaining Contacts	Locking Clip Contacts	224
Header Secured to Board During/Prior to Soldering	MTE Headers with Post Retention or Holddowns	261-268
Mate to Unshrouded Header with Retention Requirements	Mod IV plain Housing with Mod V Contacts	230
	MTE with High Pressure Contacts	251, 252
Multiple Cables to be Common to One Header	MTE Coupling Shroud, Double- or Single-Row	257, 258
Right-Angle Cable Dress	MT with Hermaphroditic Covers	275, 276, 246
Application Requires Crimp Contacts and MTE Housings	Short Point Contacts	239
Housings and End-to-End and Side-to-Side Stackable	Short Point Double-Row Housing, MTE Plain Housing	240, 245, 246
Connector Must Mate to Post Lengths of .169 [4.29] Min.	Short Point Contacts	239

.100 [2.54] Centerline Products

5

Mating Post Selection Guide

The following selection guide is provided to help in choosing a mating product after a receptacle, header or post has been selected.

In some instances references are given on the catalog page to specific mating connectors. In other instances the reader is referred here to the selection guide for mating product recommendations.

If your application requirement is not answered here, consult Tyco Electronics for further recommendations.

Posts Without Shoulders

For drawn wire products (ie, AMPMODU Breakaway and Low Profile Headers) and for products having the shoulder of the post below the housing or pc board surface (ie, AMPMODU MTE and Single Row Shrouded Headers) the effective mating length starts at the housing or pc board surface.

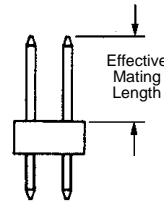

Posts With Shoulders

For product having the shoulder of the post extending above the housing or pc board surface (ie, Standard AMPMODU Shrouded and Unshrouded Headers) the effective mating length starts at the top of the shoulder.

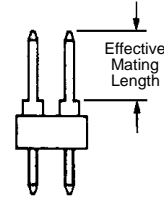

Receptacle Type	Recommended Effective Mating Posts Lengths	
	Minimum	Maximum
AMPMODU Mod II Horizontal Board Mount Receptacle, Single and Double Row, Short Point-of-Contact—pages 186-187,189-190	.230 [5.84]	.280 [7.11]
AMPMODU Mod II Vertical Board Mount Receptacle, Single Row, Standard Profile, Top Entry—page 192	.183 [4.65]	.330 [8.38]
AMPMODU Mod II Vertical Board Mount Receptacle, Standard Profile, Double Row, Top Entry, 100 x .100 mt.—page 193	.183 [4.65]	.330 [8.38]
AMPMODU Mod IV Vertical Board Mount Receptacle, Low Profile, Single Row, Top Entry, Single Tine—page 195	.183 [4.65]	.255 [6.48]
AMPMODU Mod IV Vertical Board Mount Receptacle, Low Profile, Single Row, Bottom Entry—page 194	.280 [7.11]	*
AMPMODU Mod IV Vertical Board Mount Receptacle, Low Profile, Double Row, Top Entry—pages 196,197	.183 [4.65]	.255 [6.48]
AMPMODU Surface-Mount Receptacle, Top Entry	.183 [4.65]	*
AMPMODU Surface-Mount Receptacle, Bottom Entry	.204 [5.18]	*
AMPMODU Mod IV Vertical Board Mount Receptacle, Low Profile, Double Row, Dual Entry—page 199	Top Entry .183 [4.65] Bottom Entry .204 [5.18]	* *
AMPMODU Surface-Mount Receptacle, Top Entry	.183 [4.65]	*
AMPMODU Surface-Mount Receptacle, Bottom Entry	.204 [5.18]	*
AMPMODU .600 [15.24] Mod IV Housing with Standard Pressure Contacts—pages 228-237	.210 [5.33]	.283 [7.19]
AMPMODU .600 [15.24] Mod IV Housing with Intermediate Pressure Contacts—pages 228-237	.205 [5.21]	.283 [7.19]
AMPMODU .600 [15.24] Mod IV Housing with High Pressure Contacts—pages 228-237	.185 [4.70]	.283 [7.19]
AMPMODU Mod IV Vertical Board Mount Receptacle, Low Profile, Single Row, Dual Entry—page 198	Top Entry .183 [4.65] Bottom Entry .204 [5.18]	* *

Receptacle Type	Recommended Effective Mating Posts Lengths	
	Minimum	Maximum
Short Point Housing with Contacts—pages 239-241	.169 [4.29]	.259 [6.58]
AMPMODU MTE Unloaded Housing with Short Point Contacts—pages 239, 246-249	.169 [4.29]	.259 [6.58]
AMPMODU MTE IDC Assemblies	.200 [5.08]	.250 [6.35]
AMPMODU MT IDC Assembly with Standard Pressure Contacts—page 275	.222 [5.64]	.273 [6.93]
AMPMODU MT IDC Assembly with High Pressure Contacts—page 276	.200 [5.08]	.273 [6.93]
Locking Clip Housing with Contacts—pages 224-226	.273 [6.93]	.350 [8.89]
Locking Clip Contact without Housing—page 224	.200 [5.08]	.277 [7.04]
Flexible Flat Conductor Cable Receptacle with Round Wire Crimp High Pressure Contact—Catalog 82007	Single Row	.267 [6.78] .323 [8.20]
	Double Row	.282 [7.16] .323 [8.20]
Flexible Flat Conductor Cable Receptacle with Multiple Wire Crimp High Pressure Contact—Catalog 82007	Single Row	.210 [5.33] .323 [8.20]
	Double Row	.225 [5.72] .323 [8.20]
Flexible Flat Conductor Cable Receptacle with Round Wire Crimp Standard Pressure Contact—Catalog 82007	Single Row	.267 [6.78] .323 [8.20]
	Double Row	.282 [7.16] .323 [8.20]
Flexible Flat Conductor Cable Receptacle with Multiple Crimp Standard Pressure Contact—Catalog 82007	Single Row	.220 [5.59] .323 [8.20]
	Double Row	.235 [5.97] .323 [8.20]

*Maximum post length is determined by customer's application; (i.e., available space beyond rear of horizontal receptacle assembly, or above bottom entry vertical receptacle assembly or below vertical receptacle assemblies used in pass through applications).

See Figure Below	Dimension Between PC Boards	Product Family Headers (See Note 1.)	Single-Row (Page Ref.)	Double-Row (Page Ref.)	Product Family Receptacles	Single-Row (Page Ref.)	Double-Row (Page Ref.)
	.020 [0.50]	Bandolier Posts	180	NA	Mini Spring Sockets	Catalog 82172	Catalog 82172
	.060 [1.52]	Bandolier Posts	180	NA	Bottom Entry, Mod IV	194	—
1	.090 [2.29]	Breakaway** (Unshrouded)	101,102,119**	105,106,120**	Dual Entry, Mod IV	198	192
	.153 [3.89]	Surface Mount** Breakaway (Unshrouded)	NA	124	Surface Mount**, Mod IV, Entry	NA	—
	.265 [6.73]	Bandolier Posts	180	154**	Top Entry, Mod IV	195,198	196,197 (197**), 199,200-201
2	.355 [9.02]	Breakaway** (Unshrouded)	101,102,119**	105,106,120**	Top Entry, Mod IV	195,198	196,197 (197**), 199,200-201
	.385 [9.78]	Low Profile Shrouded	NA	152,154**	Top Entry, Mod IV	NA	196,197 (197**)
3	.418 [1.06]	Surface Mount** Breakaway (Unshrouded)	NA	124	Surface Mount**, Mod IV, Top Entry	NA	208-209
2*	.430 [10.92]	Breakaway** (Unshrouded)	101,102,119**	105,106,120**	Top Entry, Mod II	192	193
4*	.440 [11.18]	Shrouded, Mod II	129,130	133,135	Top Entry, Mod II or Mod IV	192,195	193,196,197
	.528 [13.41]	Stacking Shroud (See Note 2.)	NA	173 (Hood)	Inner Board Receptacle (See Note 2.)	NA	174
	.547 [13.89]	Stacking Shroud (See Note 2.)	NA	177	Outer Board Receptacle (See Note 2.)	NA	175
4	.550 [13.97]	Two-Piece Header Connector System	NA	215,216	Two-Piece Receptacle** Connector System	NA	213**
	.748 [19.00]	Stacking Shroud (See Note 2.)	NA	173 (Hood)	Inner Board Receptacle (See Note 2.)	NA	174
	.768 [19.51]	Stacking Shroud (See Note 2.)	NA	178	Outer Board Receptacle (See Note 2.)	NA	176
	.785 [19.94]	Shrouded Stacking (Limited Sizes)	NA	160	Stacking Receptacle (Limited Sizes)	NA	NA
	1.200 [30.48]	Shrouded Stacking (Limited Sizes)	NA	161	Stacking Receptacle (Limited Sizes)	NA	NA
	Various	Stacking Unshrouded	126	127	Mod II/IV Receptacles, Top/Bottom Entry	Various	Various

**High temperature version available, see page ref. listed.

Notes: 1. Headers listed are standard through hole versions. Many headers are available with retention feature and ACTIONPINposts. See product specification pages in individual sections for option availability.

2. These headers and receptacles are Related Board-to-Board products. They are not part of the AMPMODU .025 [0.64] Square Product Family.

Board-to-Board Stacking Heights (By Receptacle/Header Combination)

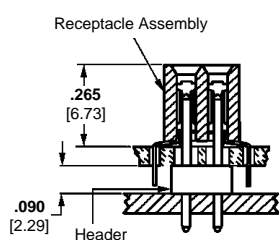

Figure 1
Double-Row, Mod IV, Bottom Entry, Breakaway Header

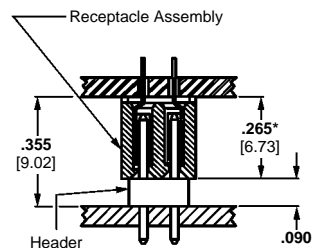

Figure 2
Double-Row, Mod IV, Top Entry, Breakaway Header

*Mod II Receptacle Height is .340 [8.64] for a total stack height of .430 [10.92]

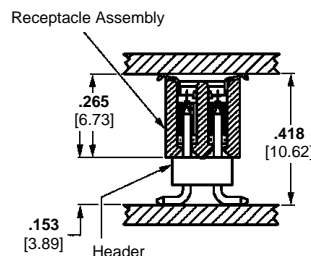

Figure 3
Double-Row, Mod IV, Surface-Mount, Top Entry, Receptacle and Surface-Mount Breakaway Header

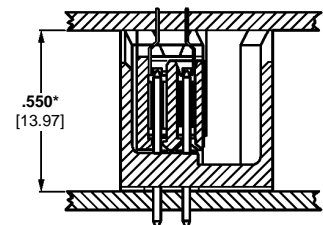

Figure 4
Double-Row, Two-Piece Receptacle and Two-Piece Shrouded Header

*Mod II Shrouded Header Height is .440 [11.18] for a total stack height of .440 [11.18]

Parallel Stacking Guide

5

Standard Headers—Unshrouded

Product Facts

- Variety of popular sizes available
- Substantial time/labor savings—install all posts at one time
- Vertical and right-angle versions available in single- and double-row configurations
- Triple-row version available in vertical configuration with .230 [5.84] mating length
- Copper alloy posts
- Choice of select gold or tin-lead plated posts
- Mating length for single and double row is .318 [8.08] (.278 [7.06] effective mating length—see page 89)
- Flame retardant, black thermoplastic housings; 94V-0 rated
- Recognized under the Component Program of Underwriters Laboratories Inc., File No. E28476
- Certified by Canadian Standards Association, File No. LR 7189

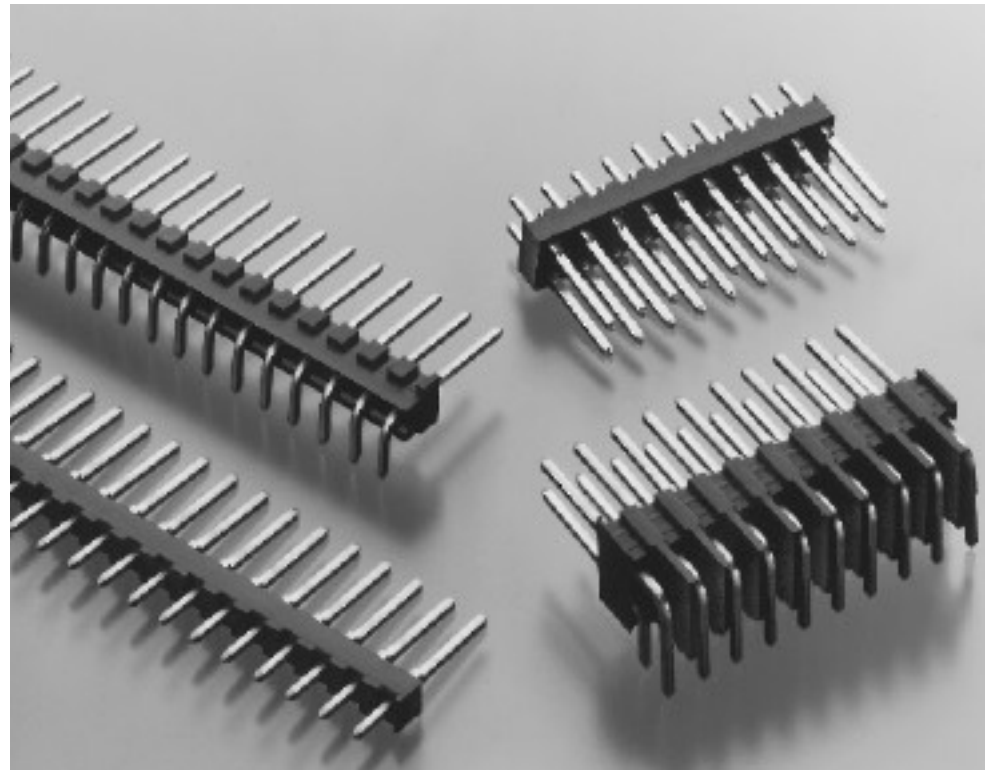

Performance Characteristics

Electrical:

Insulation Resistance—5,000 megohms minimum initial
Dielectric Withstanding Voltage—750 V rms at sea level

Environmental:

Operating Temperature—-65°C to +105°C (black thermoplastic housings)
Current—3 amperes maximum per contact (dependent upon mating connector)

Standard Headers—Unshrouded, Single Row, .100 [2.54] Centerline

.025 [0.64] Square Straight Post

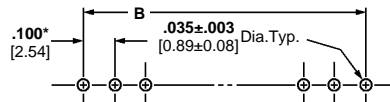
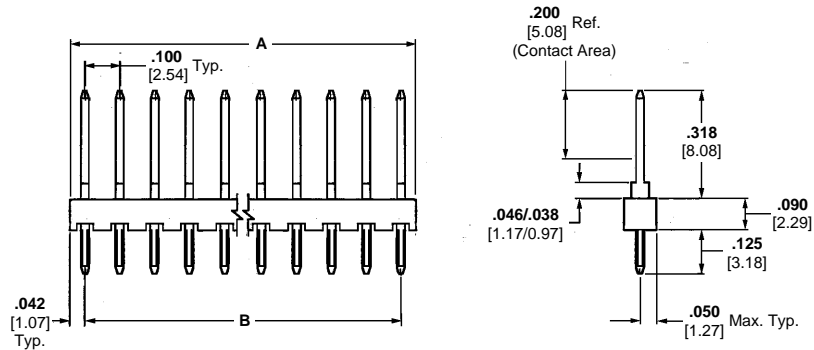

Recommended PC Board Hole Layout (for .055 [1.40] min. thick PC board)

*±.003 [±0.08] tolerances not to accumulate within one connector pattern.

Material and Finish:

Housing—Black thermoplastic, 94V-0 rated

Posts—Copper alloy, plated as follows:

Plating A—Selectively plated .000030 [0.00076] gold on contact area, with gold flash over .000050 [0.00127] nickel on entire post

Plating B—Selectively plated .000015 [0.00038] gold on contact area, with gold flash over .000050 [0.00127] nickel on entire post

Tin-Lead/Nickel—Plating option available; minimum order quantities may apply. Consult Tyco Electronics.

Related Product Data:

Mateable Connectors—Refer to the Mating Post Selection Guide (page 89)

Technical Documents (page 294):

See mating connector for applicable product and application specifications.

No. of Pos.	Dimensions		Post Plating/Part Nos.	
	A	B	Plating A	Plating B
1	.084 [2.13]	—	87220-1	87224-1
2	.184 [4.67]	.100 [2.54]	87220-2	87224-2
3	.284 [7.21]	.200 [5.08]	87220-3	87224-3
4	.384 [9.75]	.300 [7.62]	87220-4	87224-4
5	.484 [12.29]	.400 [10.16]	87220-5	87224-5
6	.584 [14.83]	.500 [12.70]	87220-6	87224-6
7	.684 [17.37]	.600 [15.24]	87220-7	87224-7
8	.784 [19.91]	.700 [17.78]	87220-8	87224-8
9	.884 [22.45]	.800 [20.32]	87220-9	87224-9
10	.984 [24.99]	.900 [22.86]	1-87220-0	1-87224-0
11	1.084 [27.53]	1.000 [25.40]	1-87220-1	1-87224-1
12	1.184 [30.07]	1.100 [27.94]	1-87220-2	1-87224-2
13	1.284 [32.61]	1.200 [30.48]	1-87220-3	1-87224-3
14	1.384 [35.15]	1.300 [33.02]	1-87220-4	1-87224-4
15	1.484 [37.69]	1.400 [35.56]	1-87220-5	1-87224-5
16	1.584 [40.23]	1.500 [38.10]	1-87220-6	1-87224-6
17	1.684 [42.77]	1.600 [40.64]	1-87220-7	1-87224-7
18	1.784 [45.31]	1.700 [43.18]	1-87220-8	1-87224-8
19	1.884 [47.85]	1.800 [45.72]	1-87220-9	1-87224-9
20	1.984 [50.39]	1.900 [48.26]	2-87220-0	2-87224-0
21	2.084 [52.93]	2.000 [50.80]	2-87220-1	2-87224-1
22	2.184 [55.47]	2.100 [53.34]	2-87220-2	2-87224-2
23	2.284 [58.01]	2.200 [55.88]	2-87220-3	2-87224-3
24	2.384 [60.55]	2.300 [58.42]	2-87220-4	2-87224-4
25	2.484 [63.09]	2.400 [60.96]	2-87220-5	2-87224-5
26	2.584 [65.63]	2.500 [63.50]	2-87220-6	2-87224-6
27	2.684 [68.17]	2.600 [66.04]	2-87220-7	2-87224-7
28	2.784 [70.71]	2.700 [68.58]	2-87220-8	2-87224-8
29	2.884 [73.25]	2.800 [71.12]	2-87220-9	2-87224-9
30	2.984 [75.79]	2.900 [73.66]	3-87220-0	3-87224-0
31	3.084 [78.33]	3.000 [76.20]	3-87220-1	3-87224-1
32	3.184 [80.87]	3.100 [78.74]	3-87220-2	3-87224-2
33	3.284 [83.41]	3.200 [81.28]	3-87220-3	3-87224-3
34	3.384 [85.95]	3.300 [83.82]	3-87220-4	3-87224-4
35	3.484 [88.49]	3.400 [86.36]	3-87220-5	3-87224-5
36	3.584 [91.03]	3.500 [88.90]	3-87220-6	3-87224-6
37	3.684 [93.57]	3.600 [91.44]	3-87220-7	3-87224-7
38	3.784 [96.11]	3.700 [93.98]	3-87220-8	3-87224-8
39	3.884 [98.65]	3.800 [96.52]	3-87220-9	3-87224-9
40	3.984 [101.19]	3.900 [99.06]	4-87220-0	4-87224-0

Unshrouded Headers

5

Standard Headers—Unshrouded, Single Row, .100 [2.54] Centerline (Continued)

.025 [0.64] Square Right-Angle Post



Material and Finish:

Housing—Black thermoplastic, 94V-0 rated

Posts—Copper alloy, plated as follows:

Plating A—Selectively plated .000030 [0.00076] gold on contact area, with gold flash over .000050 [0.00127] nickel on entire post

Plating B—Selectively plated .000015 [0.00038] gold on contact area, with gold flash over .000050 [0.00127] nickel on entire post

Tin-Lead/Nickel—Plating option available; minimum order quantities may apply. Consult Tyco Electronics.

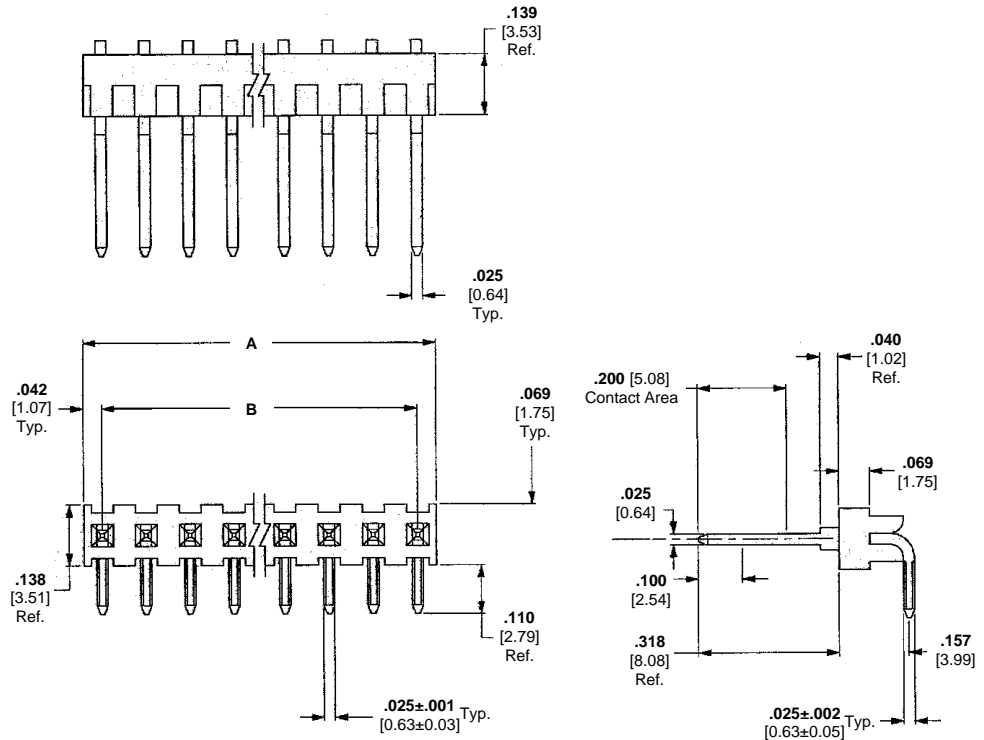

Related Product Data:

Mateable Connectors—Refer to the Mating Post Selection Guide (page 89)

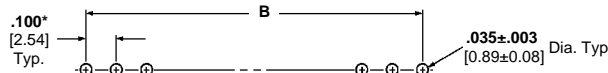

Recommended PC Board Hole Layout
(for .055 [1.40] min. thick PC board)

*±.003 [±0.08] tolerances not to accumulate within one connector pattern.

Technical Documents (page 294):

See mating connector for applicable product and application specifications.

No. of Pos.	Dimensions		Post Plating/Part Nos.	
	A	B	Plating A	Plating B
1	.084 [2.13]	—	87232-1	87233-1
2	.184 [4.67]	.100 [2.54]	87232-2	87233-2
3	.284 [7.21]	.200 [5.08]	87232-3	87233-3
4	.384 [9.75]	.300 [7.62]	87232-4	87233-4
5	.484 [12.29]	.400 [10.16]	87232-5	87233-5
6	.584 [14.83]	.500 [12.70]	87232-6	87233-6
7	.684 [17.37]	.600 [15.24]	87232-7	87233-7
8	.784 [19.91]	.700 [17.78]	87232-8	87233-8
9	.884 [22.45]	.800 [20.32]	87232-9	87233-9
10	.984 [24.99]	.900 [22.86]	1-87232-0	1-87233-0
11	1.084 [27.53]	1.000 [25.40]	1-87232-1	1-87233-1
12	1.184 [30.07]	1.100 [27.94]	1-87232-2	1-87233-2
13	1.284 [32.61]	1.200 [30.48]	1-87232-3	1-87233-3
14	1.384 [35.15]	1.300 [33.02]	1-87232-4	1-87233-4
15	1.484 [37.69]	1.400 [35.56]	1-87232-5	1-87233-5
16	1.584 [40.23]	1.500 [38.10]	1-87232-6	1-87233-6
17	1.684 [42.77]	1.600 [40.64]	1-87232-7	1-87233-7
18	1.784 [45.31]	1.700 [43.18]	1-87232-8	1-87233-8
19	1.884 [47.85]	1.800 [45.72]	1-87232-9	1-87233-9
20	1.984 [50.39]	1.900 [48.26]	2-87232-0	2-87233-0

**Standard Headers—Unshrouded, Single Row, .100 [2.54]
Centerline (Continued)**

No. of Pos.	Dimensions		Post Plating/Part Nos.	
	A	B	Plating A	Plating B
21	2.084 [52.93]	2.000 [50.80]	2-87232-1	2-87233-1
22	2.184 [55.47]	2.100 [53.34]	2-87232-2	2-87233-2
23	2.284 [58.01]	2.200 [55.88]	2-87232-3	2-87233-3
24	2.384 [60.55]	2.300 [58.42]	2-87232-4	2-87233-4
25	2.484 [63.09]	2.400 [60.96]	2-87232-5	2-87233-5
26	2.584 [65.63]	2.500 [63.50]	2-87232-6	2-87233-6
27	2.684 [68.17]	2.600 [66.04]	2-87232-7	2-87233-7
28	2.784 [70.71]	2.700 [68.58]	2-87232-8	2-87233-8
29	2.884 [73.25]	2.800 [71.12]	2-87232-9	2-87233-9
30	2.984 [75.79]	2.900 [73.66]	3-87232-0	3-87233-0
31	3.084 [78.33]	3.000 [76.20]	3-87232-1	3-87233-1
32	3.184 [80.87]	3.100 [78.74]	3-87232-2	3-87233-2
33	3.284 [83.41]	3.200 [81.28]	3-87232-3	3-87233-3
34	3.385 [85.95]	3.300 [83.82]	3-87232-4	3-87233-4
35	3.484 [88.49]	3.400 [86.36]	3-87232-5	3-87233-5
36	3.584 [91.03]	3.500 [88.90]	3-87232-6	3-87233-6
37	3.684 [93.57]	3.600 [91.44]	3-87232-7	3-87233-7
38	3.784 [96.11]	3.700 [93.98]	3-87232-8	3-87233-8
39	3.884 [98.65]	3.800 [96.52]	3-87232-9	3-87233-9
40	3.984 [101.19]	3.900 [99.06]	4-87232-0	4-87233-0

**Standard Headers—Unshrouded, Double-Row,
.100 x .100 [2.54 x 2.54] Centerline**

**.025 [0.64] Square
Straight Post**



Material and Finish:

Housing—Black thermoplastic, 94V-0 rated

Posts—Copper alloy, plated as follows:

Plating A—Selectively plated .000030 [0.00076] gold on contact area, with gold flash over .000050 [0.00127] nickel on entire post

Plating B—Selectively plated .000015 [0.00038] gold on contact area, with gold flash over .000050 [0.00127] nickel on entire post

Tin-Lead/Nickel—Plating option available; minimum order quantities may apply. Consult Tyco Electronics.

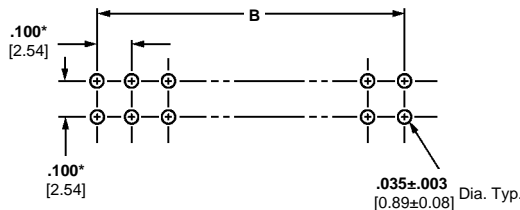
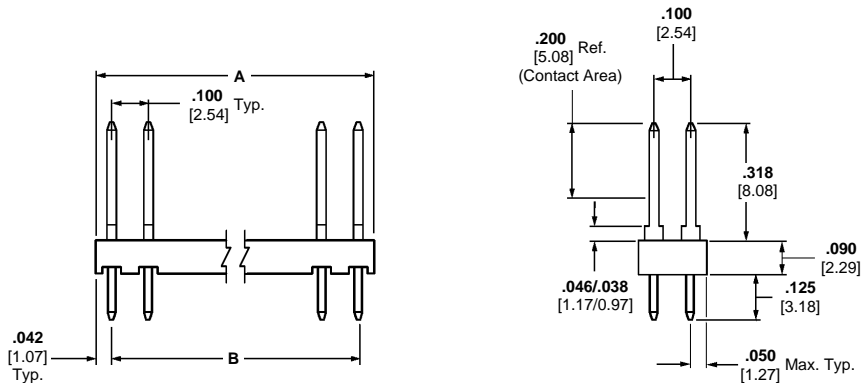

**Recommended PC Board Hole Layout
(for .055 [1.40] min. thick PC board)**

*±.003 [±0.08] tolerances not to accumulate within one connector pattern.

Related Product Data:

Mateable Connectors—Refer to the Mating Post Selection Guide (page 89)

Accessories:

Barrier Insert—page 221

Technical Documents (page 294):

See mating connector for applicable product and application specifications.

No. of Pos.	Dimensions		Post Plating/Part Nos.	
	A	B	Plating A	Plating B
2	.084 [2.13]	—	1-87215-0	87227-1
4	.184 [4.67]	.100 [2.54]	1-87215-1	87227-2
6	.284 [7.21]	.200 [5.08]	1-87215-2	87227-3
8	.384 [9.75]	.300 [7.62]	87215-1	87227-4
10	.484 [12.29]	.400 [10.16]	87215-2	87227-5
12	.584 [14.83]	.500 [12.70]	87215-3	87227-6
14	.684 [17.37]	.600 [15.24]	87215-4	87227-7
16	.784 [19.91]	.700 [17.78]	87215-5	87227-8
18	.884 [22.45]	.800 [20.32]	87215-6	87227-9
20	.984 [24.99]	.900 [22.86]	87215-7	1-87227-0
22	1.084 [27.53]	1.000 [25.40]	1-87215-3	1-87227-1
24	1.184 [30.07]	1.100 [27.94]	87215-8	1-87227-2
26	1.284 [32.61]	1.200 [30.48]	87215-9	1-87227-3
28	1.384 [35.15]	1.300 [33.02]	1-87215-4	1-87227-4
30	1.484 [37.69]	1.400 [35.56]	1-87215-5	1-87227-5
32	1.584 [40.23]	1.500 [38.10]	1-87215-6	1-87227-6
34	1.684 [42.77]	1.600 [40.64]	1-87215-7	1-87227-7
36	1.784 [45.31]	1.700 [43.18]	1-87215-8	1-87227-8
38	1.884 [47.85]	1.800 [45.72]	1-87215-9	1-87227-9
40	1.984 [50.39]	1.900 [48.26]	2-87215-0	2-87227-0

**Standard Headers—Unshrouded, Double-Row,
.100 x .100 [2.54 x 2.54] Centerline** (Continued)

No. of Pos.	Dimensions		Post Plating/Part Nos.	
	A	B	Plating A	Plating B
42	2.084 [52.93]	2.000 [50.80]	2-87215-1	2-87227-1
44	2.184 [55.47]	2.100 [53.34]	2-87215-2	2-87227-2
46	2.284 [58.01]	2.200 [55.88]	2-87215-3	2-87227-3
48	2.384 [60.55]	2.300 [58.42]	2-87215-4	2-87227-4
50	2.484 [63.09]	2.400 [60.96]	2-87215-5	2-87227-5
52	2.584 [65.63]	2.500 [63.50]	2-87215-6	2-87227-6
54	2.684 [68.17]	2.600 [66.04]	2-87215-7	2-87227-7
56	2.784 [70.71]	2.700 [68.58]	2-87215-8	2-87227-8
58	2.884 [73.25]	2.800 [71.12]	2-87215-9	2-87227-9
60	2.984 [75.79]	2.900 [73.66]	3-87215-0	3-87227-0
62	3.084 [78.33]	3.000 [76.20]	3-87215-1	3-87227-1
64	3.184 [80.87]	3.100 [78.74]	3-87215-2	3-87227-2
66	3.284 [83.41]	3.200 [81.28]	3-87215-3	3-87227-3
68	3.384 [85.95]	3.300 [83.82]	3-87215-4	3-87227-4
70	3.484 [88.49]	3.400 [86.36]	3-87215-5	3-87227-5
72	3.584 [91.03]	3.500 [88.90]	3-87215-6	3-87227-6
74	3.684 [93.57]	3.600 [91.44]	3-87215-7	3-87227-7
76	3.784 [96.11]	3.700 [93.98]	3-87215-8	3-87227-8
78	3.884 [98.65]	3.800 [96.52]	3-87215-9	3-87227-9
80	3.984 [101.19]	3.900 [99.06]	4-87215-0	4-87227-0

Standard Headers—Unshrouded, Double-Row, .100 x .100 [2.54 x 2.54] Centerline (Continued)

.025 [0.64] Square Right-Angle Post



Material and Finish:

Housing—Black thermoplastic, 94V-0 rated

Posts—Copper alloy, plated as follows:

Plating A—Selectively plated .000030 [0.00076] gold on contact area, with gold flash over .000050 [0.00127] nickel on entire post

Plating B—Selectively plated .000015 [0.00038] gold on contact area, with gold flash over .000050 [0.00127] nickel on entire post

Tin-Lead/Nickel—Plating option available; minimum order quantities may apply. Consult Tyco Electronics.

Related Product Data:

Mateable Connectors—Refer to the Mating Post Selection Guide (page 89)

Technical Documents (page 294):

See mating connector for applicable product and application specifications.

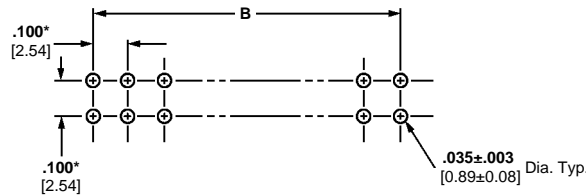
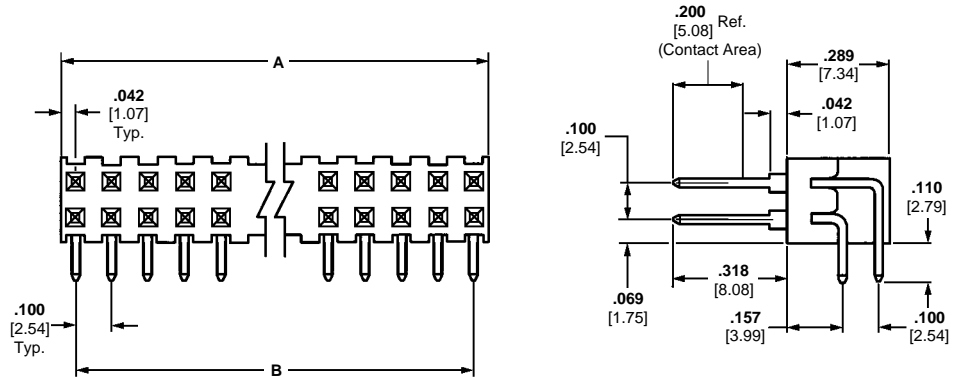

Recommended PC Board Hole Layout (for .055 [1.40] min. thick PC board)

*±.003 [±0.08] tolerances not to accumulate within one connector pattern.

No. of Pos.	Dimensions		Post Plating/Part Nos.	
	A	B	Plating A	Plating B
2	.084 [2.13]	—	1-86479-3	87230-1
4	.184 [4.67]	.100 [2.54]	1-86479-4	87230-2
6	.284 [7.21]	.200 [5.08]	1-86479-5	87230-3
8	.384 [9.75]	.300 [7.62]	1-86479-6	87230-4
10	.484 [12.29]	.400 [10.16]	86479-3	87230-5
12	.584 [14.83]	.500 [12.70]	86479-4	87230-6
14	.684 [17.37]	.600 [15.24]	86479-5	87230-7
16	.784 [19.91]	.700 [17.78]	86479-2	87230-8
18	.884 [22.45]	.800 [20.32]	86479-6	87230-9
20	.984 [24.99]	.900 [22.86]	86479-1	1-87230-0
22	1.084 [27.53]	1.000 [25.40]	1-86479-7	1-87230-1
24	1.184 [30.07]	1.100 [27.94]	86479-7	1-87230-2
26	1.284 [32.61]	1.200 [30.48]	1-86479-0	1-87230-3
28	1.384 [35.15]	1.300 [33.02]	1-86479-8	1-87230-4
30	1.484 [37.69]	1.400 [35.56]	1-86479-9	1-87230-5
32	1.584 [40.23]	1.500 [38.10]	2-86479-0	1-87230-6
34	1.684 [42.77]	1.600 [40.64]	2-86479-1	1-87230-7
36	1.784 [45.31]	1.700 [43.18]	2-86479-2	1-87230-8
38	1.884 [47.85]	1.800 [45.72]	2-86479-3	1-87230-9
40	1.984 [50.39]	1.900 [48.26]	2-86479-4	2-87230-0

**Standard Headers—Unshrouded, Double-Row,
.100 x .100 [2.54 x 2.54] Centerline** (Continued)

No. of Pos.	Dimensions		Post Plating/Part Nos.	
	A	B	Plating A	Plating B
42	2.084 [52.93]	2.000 [50.80]	2-86479-5	2-87230-1
44	2.184 [55.47]	2.100 [53.34]	2-86479-6	2-87230-2
46	2.284 [58.01]	2.200 [55.88]	2-86479-7	2-87230-3
48	2.384 [60.55]	2.300 [58.42]	2-86479-8	2-87230-4
50	2.484 [63.09]	2.400 [60.96]	2-86479-9	2-87230-5
52	2.584 [65.63]	2.500 [63.50]	3-86479-0	2-87230-6
54	2.684 [68.17]	2.600 [66.04]	3-86479-1	2-87230-7
56	2.784 [70.71]	2.700 [68.58]	3-86479-2	2-87230-8
58	2.884 [73.25]	2.800 [71.12]	3-86479-3	2-87230-9
60	2.984 [75.79]	2.900 [73.66]	3-86479-4	3-87230-0
62	3.084 [78.33]	3.000 [76.20]	3-86479-5	3-87230-1
64	3.184 [80.87]	3.100 [78.74]	3-86479-6	3-87230-2
66	3.284 [83.41]	3.200 [81.28]	3-86479-7	3-87230-3
68	3.384 [85.95]	3.300 [83.82]	3-86479-8	3-87230-4
70	3.484 [88.49]	3.400 [86.36]	3-86479-9	3-87230-5
72	3.584 [91.03]	3.500 [88.90]	4-86479-0	3-87230-6
74	3.684 [93.57]	3.600 [91.44]	4-86479-1	3-87230-7
76	3.784 [96.11]	3.700 [93.98]	4-86479-2	3-87230-8
78	3.884 [98.65]	3.800 [96.52]	4-86479-3	3-87230-9
80	3.984 [101.19]	3.900 [99.06]	4-86479-4	4-87230-0

Standard Headers—Unshrouded, Triple-Row, .100 [2.54] Centerline

.025 [0.64] Square Straight Post

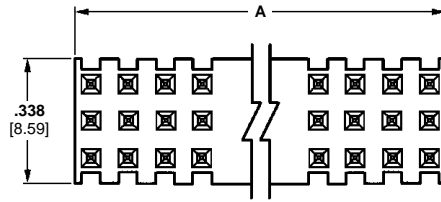

Material and Finish:

Housing—Black thermoplastic, 94V-0 rated

Posts—Copper alloy, duplex plated 000030 [0.00076] gold on contact area, .000100-.000200 [0.00254-0.00508] bright tin-lead on solder area, with entire post underplated .000050 [0.00127] nickel

Technical Documents (page 294):

See mating connector for applicable product and application specifications.

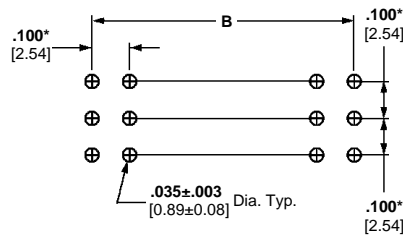
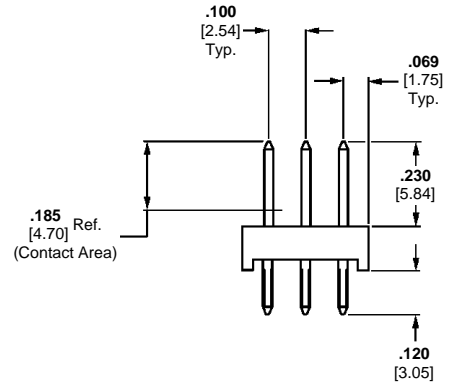
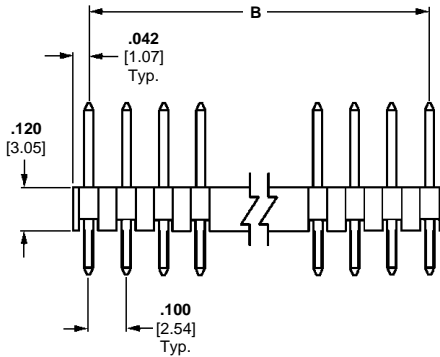

Recommended PC Board Hole Layout (for .055 [1.40] min. thick PC board)

*±.003 [±0.08] tolerances not to accumulate within one connector pattern.

No. of Pos.	Dimensions		Part Nos.
	A	B	
9	.284 [7.21]	.200 [5.08]	103817-1
12	.384 [9.75]	.300 [7.62]	103817-2
15	.484 [12.29]	.400 [10.16]	103817-3
18	.584 [14.83]	.500 [12.70]	103817-4
21	.684 [17.37]	.600 [15.24]	103817-5
24	.784 [19.91]	.700 [17.78]	103817-6
27	.884 [22.45]	.800 [20.32]	103817-7
30	.984 [24.99]	.900 [22.86]	103817-8
33	1.084 [27.53]	1.000 [25.40]	103817-9
42	1.384 [35.15]	1.300 [33.02]	1-103817-2
45	1.484 [37.69]	1.400 [35.56]	1-103817-3
60	1.984 [50.39]	1.900 [48.26]	1-103817-8
69	2.284 [58.01]	2.200 [55.88]	2-103817-1
72	2.384 [60.55]	2.300 [58.42]	2-103817-2
96	3.184 [80.87]	3.100 [78.74]	3-103817-0
120	3.984 [101.19]	3.900 [99.06]	3-103817-8

Breakaway and Retention Headers—Unshrouded

Product Facts

- Design and inventory versatility—headers can be broken into any size needed
- Variety of popular sizes available
- Substantial time/labor savings—install all posts at one time
- Vertical and right-angle versions available in single- and double-row configurations
- Phosphor bronze posts
- Choice of gold duplex or tin-lead plated posts
- Post lengths include .230 [5.84] and .318 [8.08] for connector mating
- Board retention feature available
- Flame retardant, black thermoplastic housings; 94V-0 rated
- Recognized under the Component Program of Underwriters Laboratories Inc., File No. E28476
- Certified by Canadian Standards Association, File No. LR 7189

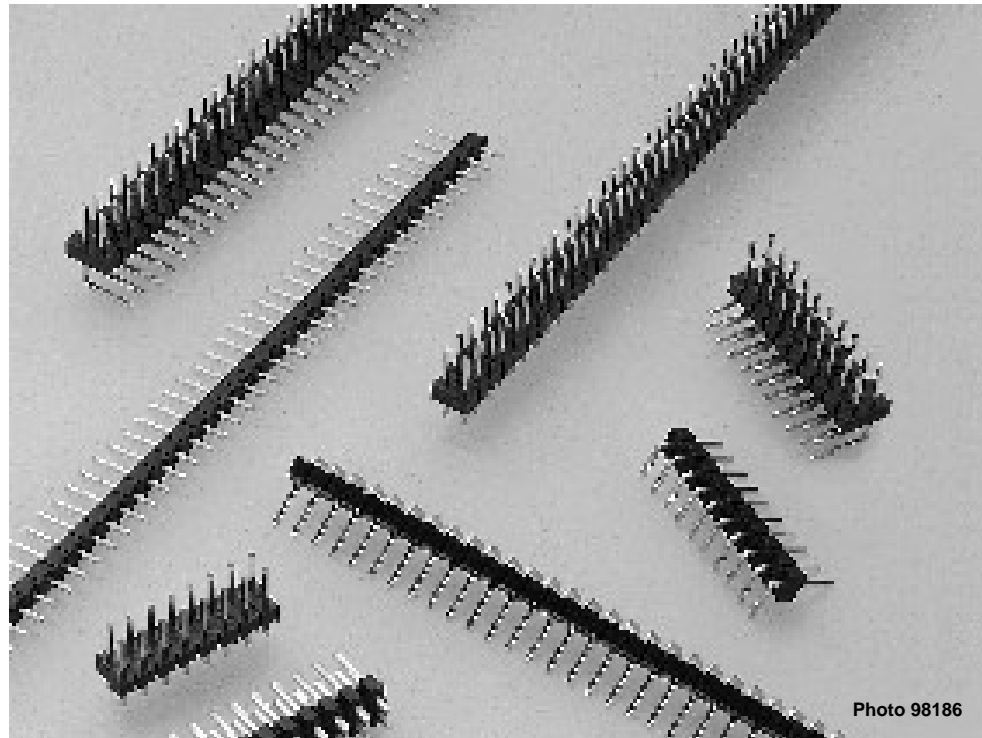

Photo 98186

Performance Characteristics

Electrical:

Insulation Resistance—5,000 megohms minimum initial

Dielectric Withstanding Voltage—750 V rms at sea level

Environmental:

Operating Temperature—-65°C to +105°C (black thermoplastic housings)

Current—3 amperes maximum per contact (dependent upon mating receptacle)

Breakaway Headers—Unshrouded, Single-Row, .100 [2.54] Centerline

.025 [0.64] Square Straight Post

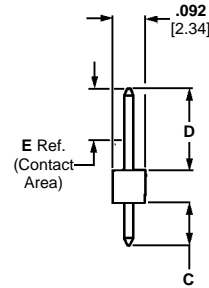
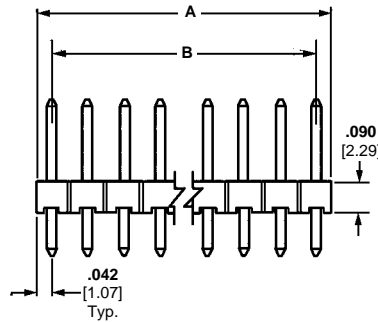

Material and Finish:

Housing—Black thermoplastic, 94V-0 rated

Posts—Phosphor bronze, plated as follows:

Plating A—Duplex plated .000030 [0.00076] gold on contact area, .000100-.000200 [0.00254-0.00508] tin-lead on solder area, with entire post underplated .000050 [0.00127] nickel

Plating B—Duplex plated .000015 [0.00038] gold on contact area, .000100-.000200 [0.00254-0.00508] tin-lead on solder area, with entire post underplated .000050 [0.00127] nickel

Plating C—.000100-.000200 [0.00254-0.00508] tin-lead over .000050 [0.00127] nickel on entire post

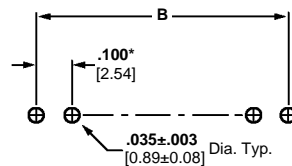

Recommended PC Board Hole Layout (for .055 [1.40] min. thick PC board)

*±.003 [±0.08] tolerances not to accumulate within one connector pattern.

Related Product Data:

Mateable Connectors—Refer to the Mating Post Selection Guide (page 89)

Technical Documents (page 294):

See mating connector for applicable product and application specifications.

No. of Pos.	Dimensions		C = .090 [2.29] D = .230 [5.84] E = .185 [4.70]			C = .120 [3.05] D = .230 [5.84] E = .185 [4.70]			C = .125 [3.18] D = .318 [8.08] E = .200 [5.08]		
	A	B	Post Plating/Part Nos.		Post Plating/Part Nos.			Post Plating/Part Nos.			
			Plating A	Plating C	Plating A	Plating B	Plating C	Plating A	Plating B	Plating C	
1	.084 [2.13]	—	103747-1	103741-1	103239-1	103185-1	103327-1	102976-1	102972-1	103321-1	
2	.184 [4.67]	.100 [2.54]	103747-2	103741-2	103239-2	103185-2	103327-2	102976-2	102972-2	103321-2	
3	.284 [7.21]	.200 [5.08]	103747-3	103741-3	103239-3	103185-3	103327-3	102976-3	102972-3	103321-3	
4	.384 [9.75]	.300 [7.62]	103747-4	103741-4	103239-4	103185-4	103327-4	102976-4	102972-4	103321-4	
5	.484 [12.29]	.400 [10.16]	103747-5	103741-5	103239-5	103185-5	103327-5	102976-5	102972-5	103321-5	
6	.584 [14.83]	.500 [12.70]	103747-6	103741-6	103239-6	103185-6	103327-6	102976-6	102972-6	103321-6	
7	.684 [17.37]	.600 [15.24]	103747-7	103741-7	103239-7	103185-7	103327-7	102976-7	102972-7	103321-7	
8	.784 [19.91]	.700 [17.78]	103747-8	103741-8	103239-8	103185-8	103327-8	102976-8	102972-8	103321-8	
9	.884 [22.45]	.800 [20.32]	103747-9	103741-9	103239-9	103185-9	103327-9	102976-9	102972-9	103321-9	
10	.984 [24.99]	.900 [22.86]	1-103747-0	1-103741-0	1-103239-0	1-103185-0	1-103327-0	1-102976-0	1-102972-0	1-103321-0	

Notes: 1. Headers may be broken to desired number of positions using **Tool Kit No. 314818-1** (not shown).
2. Other tail lengths are available, consult Tyco Electronics.

**Breakaway Headers—Unshrouded, Single Row, .100 [2.54]
Centerline (Continued)**

No. of Pos.	Dimensions		C = .090 [2.29] D = .230 [5.84] E = .185 [4.70]		C = .120 [3.05] D = .230 [5.84] E = .185 [4.70]			C = .125 [3.18] D = .318 [8.08] E = .200 [5.08]		
	A	B	Post Plating/Part Nos.		Post Plating/Part Nos.			Post Plating/Part Nos.		
			Plating A	Plating C	Plating A	Plating B	Plating C	Plating A	Plating B	Plating C
11	1.084 [27.53]	1.000 [25.40]	1-103747-1	1-103741-1	1-103239-1	1-103185-1	1-103327-1	1-102976-1	1-102972-1	1-103321-1
12	1.184 [30.07]	1.100 [27.94]	1-103747-2	1-103741-2	1-103239-2	1-103185-2	1-103327-2	1-102976-2	1-102972-2	1-103321-2
13	1.284 [32.61]	1.200 [30.48]	1-103747-3	1-103741-3	1-103239-3	1-103185-3	1-103327-3	1-102976-3	1-102972-3	1-103321-3
14	1.384 [35.15]	1.300 [33.02]	1-103747-4	1-103741-4	1-103239-4	1-103185-4	1-103327-4	1-102976-4	1-102972-4	1-103321-4
15	1.484 [37.69]	1.400 [35.56]	1-103747-5	1-103741-5	1-103239-5	1-103185-5	1-103327-5	1-102976-5	1-102972-5	1-103321-5
16	1.584 [40.23]	1.500 [38.10]	1-103747-6	1-103741-6	1-103239-6	1-103185-6	1-103327-6	1-102976-6	1-102972-6	1-103321-6
17	1.684 [42.77]	1.600 [40.64]	1-103747-7	1-103741-7	1-103239-7	1-103185-7	1-103327-7	1-102976-7	1-102972-7	1-103321-7
18	1.784 [45.31]	1.700 [43.18]	1-103747-8	1-103741-8	1-103239-8	1-103185-8	1-103327-8	1-102976-8	1-102972-8	1-103321-8
19	1.884 [47.85]	1.800 [45.72]	1-103747-9	1-103741-9	1-103239-9	1-103185-9	1-103327-9	1-102976-9	1-102972-9	1-103321-9
20	1.984 [50.39]	1.900 [48.26]	2-103747-0	2-103741-0	2-103239-0	2-103185-0	2-103327-0	2-102976-0	2-102972-0	2-103321-0
21	2.084 [52.93]	2.000 [50.80]	2-103747-1	2-103741-1	2-103239-1	2-103185-1	2-103327-1	2-102976-1	2-102972-1	2-103321-1
22	2.184 [55.47]	2.100 [53.34]	2-103747-2	2-103741-2	2-103239-2	2-103185-2	2-103327-2	2-102976-2	2-102972-2	2-103321-2
23	2.284 [58.01]	2.200 [55.88]	2-103747-3	2-103741-3	2-103239-3	2-103185-3	2-103327-3	2-102976-3	2-102972-3	2-103321-3
24	2.384 [60.55]	2.300 [58.42]	2-103747-4	2-103741-4	2-103239-4	2-103185-4	2-103327-4	2-102976-4	2-102972-4	2-103321-4
25	2.484 [63.09]	2.400 [60.96]	2-103747-5	2-103741-5	2-103239-5	2-103185-5	2-103327-5	2-102976-5	2-102972-5	2-103321-5
26	2.584 [65.63]	2.500 [63.50]	2-103747-6	2-103741-6	2-103239-6	2-103185-6	2-103327-6	2-102976-6	2-102972-6	2-103321-6
27	2.684 [68.17]	2.600 [66.04]	2-103747-7	2-103741-7	2-103239-7	2-103185-7	2-103327-7	2-102976-7	2-102972-7	2-103321-7
28	2.784 [70.71]	2.700 [68.58]	2-103747-8	2-103741-8	2-103239-8	2-103185-8	2-103327-8	2-102976-8	2-102972-8	2-103321-8
29	2.884 [73.25]	2.800 [71.12]	2-103747-9	2-103741-9	2-103239-9	2-103185-9	2-103327-9	2-102976-9	2-102972-9	2-103321-9
30	2.984 [75.79]	2.900 [73.66]	3-103747-0	3-103741-0	3-103239-0	3-103185-0	3-103327-0	3-102976-0	3-102972-0	3-103321-0
31	3.084 [78.33]	3.000 [76.20]	3-103747-1	3-103741-1	3-103239-1	3-103185-1	3-103327-1	3-102976-1	3-102972-1	3-103321-1
32	3.184 [80.87]	3.100 [78.74]	3-103747-2	3-103741-2	3-103239-2	3-103185-2	3-103327-2	3-102976-2	3-102972-2	3-103321-2
33	3.284 [83.41]	3.200 [81.28]	3-103747-3	3-103741-3	3-103239-3	3-103185-3	3-103327-3	3-102976-3	3-102972-3	3-103321-3
34	3.384 [85.95]	3.300 [83.82]	3-103747-4	3-103741-4	3-103239-4	3-103185-4	3-103327-4	3-102976-4	3-102972-4	3-103321-4
35	3.484 [88.49]	3.400 [86.36]	3-103747-5	3-103741-5	3-103239-5	3-103185-5	3-103327-5	3-102976-5	3-102972-5	3-103321-5
36	3.584 [91.03]	3.500 [88.90]	3-103747-6	3-103741-6	3-103239-6	3-103185-6	3-103327-6	3-102976-6	3-102972-6	3-103321-6
37	3.684 [93.57]	3.600 [91.44]	3-103747-7	3-103741-7	3-103239-7	3-103185-7	3-103327-7	3-102976-7	3-102972-7	3-103321-7
38	3.784 [96.11]	3.700 [93.98]	3-103747-8	3-103741-8	3-103239-8	3-103185-8	3-103327-8	3-102976-8	3-102972-8	3-103321-8
39	3.884 [98.65]	3.800 [96.52]	3-103747-9	3-103741-9	3-103239-9	3-103185-9	3-103327-9	3-102976-9	3-102972-9	3-103321-9
40	3.984 [101.19]	3.900 [99.06]	4-103747-0	4-103741-0	4-103239-0	4-103185-0	4-103327-0	4-102976-0	4-102972-0	4-103321-0

Notes: 1. Headers may be broken to desired number of positions using **Tool Kit No. 314818-1** (not shown).
2. Other tail lengths are available, consult Tyco Electronics.

Breakaway and Retention Headers-Unshrouded

5

Breakaway Headers—Unshrouded, Single Row, .100 [2.54] Centerline (Continued)

.025 [0.64] Square Right-Angle Post

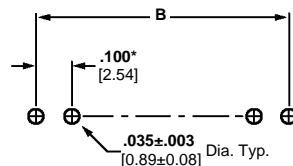
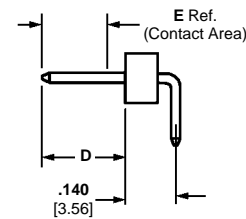
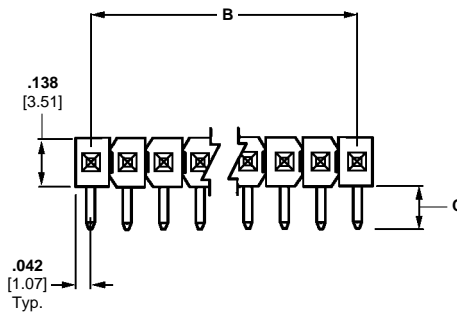
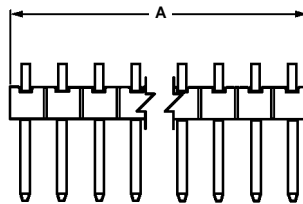

Material and Finish:

Housing—Black thermoplastic, 94V-0 rated

Posts—Phosphor bronze, plated as follows:

Plating A—Duplex plated .000030 [0.00076] gold on contact area, .000100-.000200 [0.00254-0.00508] tin-lead on solder area, with entire post underplated .000050 [0.00127] nickel

Plating B—Duplex plated .000015 [0.00038] gold on contact area, .000100-.000200 [0.00254-0.00508] tin-lead on solder area, with entire post underplated .000050 [0.00127] nickel

Plating C—.000100-.000200 [0.00254-0.00508] tin-lead over .000050 [0.00127] nickel on entire post

Related Product Data:

Mateable Connectors—Refer to the Mating Post Selection Guide (page 89)

Technical Documents (page 294):

See mating connector for applicable product and application specifications.

Recommended PC Board Hole Layout (for .055 [1.40] min. thick PC board)

*±.003 [±0.08] tolerances not to accumulate within one connector pattern.

No. of Pos.	Dimensions		C = .090 [2.29] D = .230 [5.84] E = .185 [4.70]			C = .120 [3.05] D = .230 [5.84] E = .185 [4.70]			C = .110 [2.79] D = .318 [8.08] E = .200 [5.08]		
	A	B	Post Plating/Part Nos.		Post Plating/Part Nos.			Post Plating/Part Nos.			
			Plating A	Plating C	Plating A	Plating B	Plating C	Plating A	Plating B	Plating C	
1	.084 [2.13]	—	103765-1	103759-1	103148-1	103325-1	103329-1	102978-1	102974-1	103323-1	
2	.184 [4.67]	.100 [2.54]	103765-2	103759-2	103148-2	103325-2	103329-2	102978-2	102974-2	103323-2	
3	.284 [7.21]	.200 [5.08]	103765-3	103759-3	103148-3	103325-3	103329-3	102978-3	102974-3	103323-3	
4	.384 [9.75]	.300 [7.62]	103765-4	103759-4	103148-4	103325-4	103329-4	102978-4	102974-4	103323-4	
5	.484 [12.29]	.400 [10.16]	103765-5	103759-5	103148-5	103325-5	103329-5	102978-5	102974-5	103323-5	
6	.584 [14.83]	.500 [12.70]	103765-6	103759-6	103148-6	103325-6	103329-6	102978-6	102974-6	103323-6	
7	.684 [17.37]	.600 [15.24]	103765-7	103759-7	103148-7	103325-7	103329-7	102978-7	102974-7	103323-7	
8	.784 [19.91]	.700 [17.78]	103765-8	103759-8	103148-8	103325-8	103329-8	102978-8	102974-8	103323-8	
9	.884 [22.45]	.800 [20.32]	103765-9	103759-9	103148-9	103325-9	103329-9	102978-9	102974-9	103323-9	
10	.984 [24.99]	.900 [22.86]	1-103765-0	1-103759-0	1-103148-0	1-103325-0	1-103329-0	1-102978-0	1-102974-0	1-103323-0	

Notes: 1. Headers may be broken to desired number of positions using **Tool Kit No. 314818-1** (not shown).
2. Other tail lengths are available, consult Tyco Electronics.

**Breakaway Headers—Unshrouded, Single Row, .100 [2.54]
Centerline (Continued)**

No. of Pos.	Dimensions		C = .090 [2.29] D = .230 [5.84] E = .185 [4.70]		C = .120 [3.05] D = .230 [5.84] E = .185 [4.70]			C = .110 [2.79] D = .318 [8.08] E = .200 [5.08]		
	A	B	Post Plating/Part Nos.		Post Plating/Part Nos.			Post Plating/Part Nos.		
			Plating A	Plating C	Plating A	Plating B	Plating C	Plating A	Plating B	Plating C
11	1.084 [27.53]	1.000 [25.40]	1-103765-1	1-103759-1	1-103148-1	1-103325-1	1-103329-1	1-102978-1	1-102974-1	1-103323-1
12	1.184 [30.07]	1.100 [27.94]	1-103765-2	1-103759-2	1-103148-2	1-103325-2	1-103329-2	1-102978-2	1-102974-2	1-103323-2
13	1.284 [32.61]	1.200 [30.48]	1-103765-3	1-103759-3	1-103148-3	1-103325-3	1-103329-3	1-102978-3	1-102974-3	1-103323-3
14	1.384 [35.15]	1.300 [33.02]	1-103765-4	1-103759-4	1-103148-4	1-103325-4	1-103329-4	1-102978-4	1-102974-4	1-103323-4
15	1.484 [37.69]	1.400 [35.56]	1-103765-5	1-103759-5	1-103148-5	1-103325-5	1-103329-5	1-102978-5	1-102974-5	1-103323-5
16	1.584 [40.23]	1.500 [38.10]	1-103765-6	1-103759-6	1-103148-6	1-103325-6	1-103329-6	1-102978-6	1-102974-6	1-103323-6
17	1.684 [42.77]	1.600 [40.64]	1-103765-7	1-103759-7	1-103148-7	1-103325-7	1-103329-7	1-102978-7	1-102974-7	1-103323-7
18	1.784 [45.31]	1.700 [43.18]	1-103765-8	1-103759-8	1-103148-8	1-103325-8	1-103329-8	1-102978-8	1-102974-8	1-103323-8
19	1.884 [47.85]	1.800 [45.72]	1-103765-9	1-103759-9	1-103148-9	1-103325-9	1-103329-9	1-102978-9	1-102974-9	1-103323-9
20	1.984 [50.39]	1.900 [48.26]	2-103765-0	2-103759-0	2-103148-0	2-103325-0	2-103329-0	2-102978-0	2-102974-0	2-103323-0
21	2.084 [52.93]	2.000 [50.80]	2-103765-1	2-103759-1	2-103148-1	2-103325-1	2-103329-1	2-102978-1	2-102974-1	2-103323-1
22	2.184 [55.47]	2.100 [53.34]	2-103765-2	2-103759-2	2-103148-2	2-103325-2	2-103329-2	2-102978-2	2-102974-2	2-103323-2
23	2.284 [58.01]	2.200 [55.88]	2-103765-3	2-103759-3	2-103148-3	2-103325-3	2-103329-3	2-102978-3	2-102974-3	2-103323-3
24	2.384 [60.55]	2.300 [58.42]	2-103765-4	2-103759-4	2-103148-4	2-103325-4	2-103329-4	2-102978-4	2-102974-4	2-103323-4
25	2.484 [63.09]	2.400 [60.96]	2-103765-5	2-103759-5	2-103148-5	2-103325-5	2-103329-5	2-102978-5	2-102974-5	2-103323-5
26	2.584 [65.63]	2.500 [63.50]	2-103765-6	2-103759-6	2-103148-6	2-103325-6	2-103329-6	2-102978-6	2-102974-6	2-103323-6
27	2.684 [68.17]	2.600 [66.04]	2-103765-7	2-103759-7	2-103148-7	2-103325-7	2-103329-7	2-102978-7	2-102974-7	2-103323-7
28	2.784 [70.71]	2.700 [68.58]	2-103765-8	2-103759-8	2-103148-8	2-103325-8	2-103329-8	2-102978-8	2-102974-8	2-103323-8
29	2.884 [73.25]	2.800 [71.12]	2-103765-9	2-103759-9	2-103148-9	2-103325-9	2-103329-9	2-102978-9	2-102974-9	2-103323-9
30	2.984 [75.79]	2.900 [73.66]	3-103765-0	3-103759-0	3-103148-0	3-103325-0	3-103329-0	3-102978-0	3-102974-0	3-103323-0
31	3.084 [78.33]	3.000 [76.20]	3-103765-1	3-103759-1	3-103148-1	3-103325-1	3-103329-1	3-102978-1	3-102974-1	3-103323-1
32	3.184 [80.87]	3.100 [78.74]	3-103765-2	3-103759-2	3-103148-2	3-103325-2	3-103329-2	3-102978-2	3-102974-2	3-103323-2
33	3.284 [83.41]	3.200 [81.28]	3-103765-3	3-103759-3	3-103148-3	3-103325-3	3-103329-3	3-102978-3	3-102974-3	3-103323-3
34	3.384 [85.95]	3.300 [83.82]	3-103765-4	3-103759-4	3-103148-4	3-103325-4	3-103329-4	3-102978-4	3-102974-4	3-103323-4
35	3.484 [88.49]	3.400 [86.36]	3-103765-5	3-103759-5	3-103148-5	3-103325-5	3-103329-5	3-102978-5	3-102974-5	3-103323-5
36	3.584 [91.03]	3.500 [88.90]	3-103765-6	3-103759-6	3-103148-6	3-103325-6	3-103329-6	3-102978-6	3-102974-6	3-103323-6
37	3.684 [93.57]	3.600 [91.44]	3-103765-7	3-103759-7	3-103148-7	3-103325-7	3-103329-7	3-102978-7	3-102974-7	3-103323-7
38	3.784 [96.11]	3.700 [93.98]	3-103765-8	3-103759-8	3-103148-8	3-103325-8	3-103329-8	3-102978-8	3-102974-8	3-103323-8
39	3.884 [98.65]	3.800 [96.52]	3-103765-9	3-103759-9	3-103148-9	3-103325-9	3-103329-9	3-102978-9	3-102974-9	3-103323-9
40	3.984 [101.19]	3.900 [99.06]	4-103765-0	4-103759-0	4-103148-0	4-103325-0	4-103329-0	4-102978-0	4-102974-0	4-103323-0

Notes: 1. Headers may be broken to desired number of positions using Tool Kit No. 314818-1 (not shown).
2. Other tail lengths are available, consult Tyco Electronics.

Breakaway Headers—Unshrouded, Double-Row, .100 x .100 [2.54 x 2.54] Centerline

.025 [0.64] Square Straight-Angle Post



Material and Finish:

Housing—Black thermoplastic, 94V-0 rated

Posts—Phosphor bronze, plated as follows:

Plating A—Duplex plated .000030 [0.00076] gold on contact area, .000100-.000200 [0.00254-0.00508] tin-lead on solder area, with entire post underplated .000050 [0.00127] nickel

Plating B—Duplex plated .000015 [0.00038] gold on contact area, .000100-.000200 [0.00254-0.00508] tin-lead on solder area, with entire post underplated .000050 [0.00127] nickel

Plating C—.000100-.000200 [0.00254-0.00508] tin-lead over .000050 [0.00127] nickel on entire post

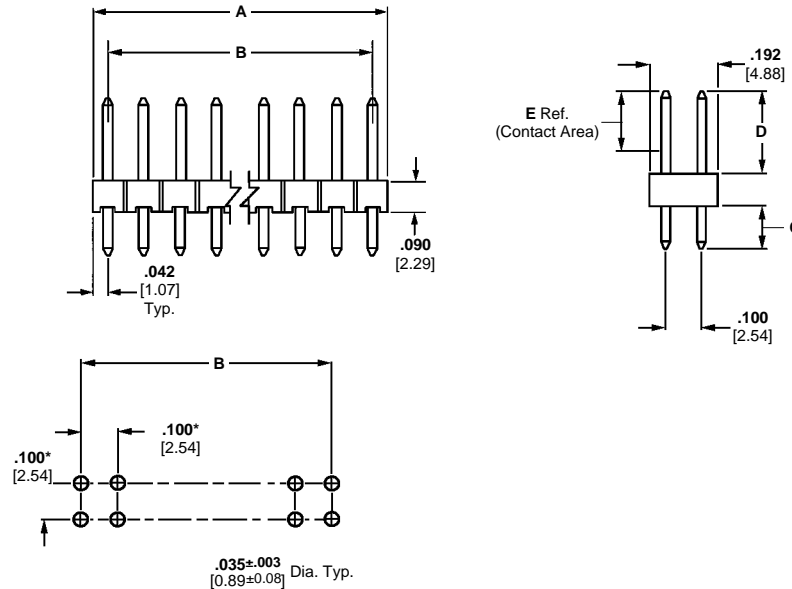

Recommended PC Board Hole Layout (for .055 [1.40] min. thick PC board)

*±.003 [±0.08] tolerances not to accumulate within one connector pattern.

Related Product Data:

Mateable Connectors—Refer to the Mating Post Selection Guide (page 89)

Accessories:

Barrier Insert—page 221

Technical Documents (page 294):

See mating connector for applicable product and application specifications.

No. of Pos.	Dimensions		C = .090 [2.29] D = .230 [5.84] E = .185 [4.70]		C = .120 [3.05] D = .230 [5.84] E = .185 [4.70]			C = .125 [3.18] D = .318 [8.08] E = .200 [5.08]		
	A	B	Post Plating/Part Nos.		Post Plating/Part Nos.			Post Plating/Part Nos.		
			Plating A	Plating C	Plating A	Plating B	Plating C	Plating A	Plating B	Plating C
2	.084 [2.13]	—	103783-1	103777-1	103240-1	103186-1	103328-1	102977-1	102973-1	103322-1
4	.184 [4.67]	.100 [2.54]	103783-2	103777-2	103240-2	103186-2	103328-2	102977-2	102973-2	103322-2
6	.284 [7.21]	.200 [5.08]	103783-3	103777-3	103240-3	103186-3	103328-3	102977-3	102973-3	103322-3
8	.384 [9.75]	.300 [7.62]	103783-4	103777-4	103240-4	103186-4	103328-4	102977-4	102973-4	103322-4
10	.484 [12.29]	.400 [10.16]	103783-5	103777-5	103240-5	103186-5	103328-5	102977-5	102973-5	103322-5
12	.584 [14.83]	.500 [12.70]	103783-6	103777-6	103240-6	103186-6	103328-6	102977-6	102973-6	103322-6
14	.684 [17.37]	.600 [15.24]	103783-7	103777-7	103240-7	103186-7	103328-7	102977-7	102973-7	103322-7
16	.784 [19.91]	.700 [17.78]	103783-8	103777-8	103240-8	103186-8	103328-8	102977-8	102973-8	103322-8
18	.884 [22.45]	.800 [20.32]	103783-9	103777-9	103240-9	103186-9	103328-9	102977-9	102973-9	103322-9
20	.984 [24.99]	.900 [22.86]	1-103783-0	1-103777-0	1-103240-0	1-103186-0	1-103328-0	1-102977-0	1-102973-0	1-103322-0

Notes: 1. Headers may be broken to desired number of positions using **Tool Kit No. 314818-1** (not shown).
2. Other tail lengths are available, consult Tyco Electronics.

**Breakaway Headers—Unshrouded, Double-Row,
.100 x .100 [2.54 x 2.54] Centerline (Continued)**

No. of Pos.	Dimensions		C = .090 [2.29] D = .230 [5.84] E = .185 [4.70]		C = .120 [3.05] D = .230 [5.84] E = .185 [4.70]			C = .125 [3.18] D = .318 [8.08] E = .200 [5.08]		
	A	B	Post Plating/Part Nos.		Post Plating/Part Nos.			Post Plating/Part Nos.		
			Plating A	Plating C	Plating A	Plating B	Plating C	Plating A	Plating B	Plating C
22	1.084 [27.53]	1.000 [25.40]	1-103783-1	1-103777-1	1-103240-1	1-103186-1	1-103328-1	1-102977-1	1-102973-1	1-103322-1
24	1.184 [30.07]	1.100 [27.94]	1-103783-2	1-103777-2	1-103240-2	1-103186-2	1-103328-2	1-102977-2	1-102973-2	1-103322-2
26	1.284 [32.61]	1.200 [30.48]	1-103783-3	1-103777-3	1-103240-3	1-103186-3	1-103328-3	1-102977-3	1-102973-3	1-103322-3
28	1.384 [35.15]	1.300 [33.02]	1-103783-4	1-103777-4	1-103240-4	1-103186-4	1-103328-4	1-102977-4	1-102973-4	1-103322-4
30	1.484 [37.69]	1.400 [35.56]	1-103783-5	1-103777-5	1-103240-5	1-103186-5	1-103328-5	1-102977-5	1-102973-5	1-103322-5
32	1.584 [40.23]	1.500 [38.10]	1-103783-6	1-103777-6	1-103240-6	1-103186-6	1-103328-6	1-102977-6	1-102973-6	1-103322-6
34	1.684 [42.77]	1.600 [40.64]	1-103783-7	1-103777-7	1-103240-7	1-103186-7	1-103328-7	1-102977-7	1-102973-7	1-103322-7
36	1.784 [45.31]	1.700 [43.18]	1-103783-8	1-103777-8	1-103240-8	1-103186-8	1-103328-8	1-102977-8	1-102973-8	1-103322-8
38	1.884 [47.85]	1.800 [45.72]	1-103783-9	1-103777-9	1-103240-9	1-103186-9	1-103328-9	1-102977-9	1-102973-9	1-103322-9
40	1.984 [50.39]	1.900 [48.26]	2-103783-0	2-103777-0	2-103240-0	2-103186-0	2-103328-0	2-102977-0	2-102973-0	2-103322-0
42	2.084 [52.93]	2.000 [50.80]	2-103783-1	2-103777-1	2-103240-1	2-103186-1	2-103328-1	2-102977-1	2-102973-1	2-103322-1
44	2.184 [55.47]	2.100 [53.34]	2-103783-2	2-103777-2	2-103240-2	2-103186-2	2-103328-2	2-102977-2	2-102973-2	2-103322-2
46	2.284 [58.01]	2.200 [55.88]	2-103783-3	2-103777-3	2-103240-3	2-103186-3	2-103328-3	2-102977-3	2-102973-3	2-103322-3
48	2.384 [60.55]	2.300 [58.42]	2-103783-4	2-103777-4	2-103240-4	2-103186-4	2-103328-4	2-102977-4	2-102973-4	2-103322-4
50	2.484 [63.09]	2.400 [60.96]	2-103783-5	2-103777-5	2-103240-5	2-103186-5	2-103328-5	2-102977-5	2-102973-5	2-103322-5
52	2.584 [65.63]	2.500 [63.50]	2-103783-6	2-103777-6	2-103240-6	2-103186-6	2-103328-6	2-102977-6	2-102973-6	2-103322-6
54	2.684 [68.17]	2.600 [66.04]	2-103783-7	2-103777-7	2-103240-7	2-103186-7	2-103328-7	2-102977-7	2-102973-7	2-103322-7
56	2.784 [70.71]	2.700 [68.58]	2-103783-8	2-103777-8	2-103240-8	2-103186-8	2-103328-8	2-102977-8	2-102973-8	2-103322-8
58	2.884 [73.25]	2.800 [71.12]	2-103783-9	2-103777-9	2-103240-9	2-103186-9	2-103328-9	2-102977-9	2-102973-9	2-103322-9
60	2.984 [75.79]	2.900 [73.66]	3-103783-0	3-103777-0	3-103240-0	3-103186-0	3-103328-0	3-102977-0	3-102973-0	3-103322-0
62	3.084 [78.33]	3.000 [76.20]	3-103783-1	3-103777-1	3-103240-1	3-103186-1	3-103328-1	3-102977-1	3-102973-1	3-103322-1
64	3.184 [80.87]	3.100 [78.74]	3-103783-2	3-103777-2	3-103240-2	3-103186-2	3-103328-2	3-102977-2	3-102973-2	3-103322-2
66	3.284 [83.41]	3.200 [81.28]	3-103783-3	3-103777-3	3-103240-3	3-103186-3	3-103328-3	3-102977-3	3-102973-3	3-103322-3
68	3.384 [85.95]	3.300 [83.82]	3-103783-4	3-103777-4	3-103240-4	3-103186-4	3-103328-4	3-102977-4	3-102973-4	3-103322-4
70	3.484 [88.49]	3.400 [86.36]	3-103783-5	3-103777-5	3-103240-5	3-103186-5	3-103328-5	3-102977-5	3-102973-5	3-103322-5
72	3.584 [91.03]	3.500 [88.90]	3-103783-6	3-103777-6	3-103240-6	3-103186-6	3-103328-6	3-102977-6	3-102973-6	3-103322-6
74	3.684 [93.57]	3.600 [91.44]	3-103783-7	3-103777-7	3-103240-7	3-103186-7	3-103328-7	3-102977-7	3-102973-7	3-103322-7
76	3.784 [96.11]	3.700 [93.98]	3-103783-8	3-103777-8	3-103240-8	3-103186-8	3-103328-8	3-102977-8	3-102973-8	3-103322-8
78	3.884 [98.65]	3.800 [96.52]	3-103783-9	3-103777-9	3-103240-9	3-103186-9	3-103328-9	3-102977-9	3-102973-9	3-103322-9
80	3.984 [101.19]	3.900 [99.06]	4-103783-0	4-103777-0	4-103240-0	4-103186-0	4-103328-0	4-102977-0	4-102973-0	4-103322-0

Notes: 1. Headers may be broken to desired number of positions using **Tool Kit No. 314818-1** (not shown).
2. Other tail lengths are available, consult Tyco Electronics.

Breakaway and Retention Headers-Unshrouded

5

Breakaway Headers—Unshrouded, Double-Row, .100 x .100 [2.54 x 2.54] Centerline

.025 [0.64] Square Right-Angle Post

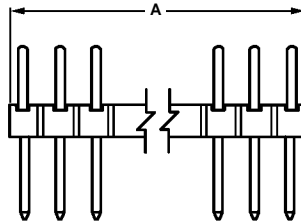

Material and Finish:

Housing—Black thermoplastic, 94V-0 rated

Posts—Phosphor bronze, plated as follows:

Plating A—Duplex plated .000030 [0.00076] gold on contact area, .000100-.000200 [0.00254-0.00508] tin-lead on solder area, with entire post underplated .000050 [0.00127] nickel

Plating B—Duplex plated .000015 [0.00038] gold on contact area, .000100-.000200 [0.00254-0.00508] tin-lead on solder area, with entire post underplated .000050 [0.00127] nickel

Plating C—.000100-.000200 [0.00254-0.00508] tin-lead over .000050 [0.00127] nickel on entire post

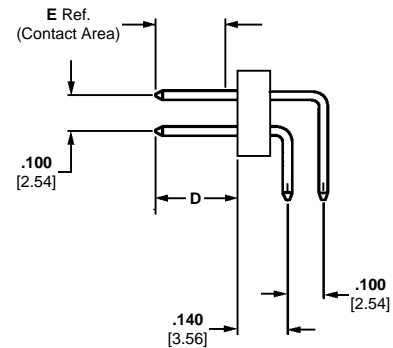
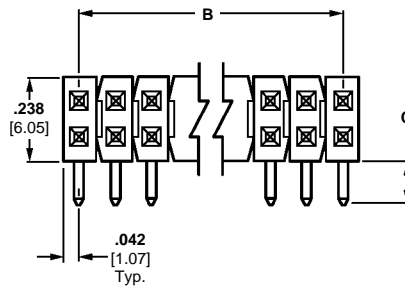

Related Product Data:

Mateable Connectors—Refer to the Mating Post Selection Guide (page 89)

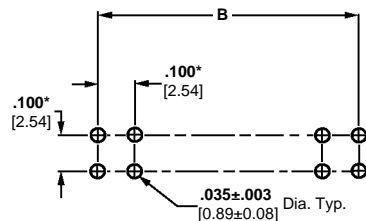

Recommended PC Board Hole Layout (for .055 [1.40] min. thick PC board)

Technical Documents (page 294):

See mating connector for applicable product and application specifications.

*±.003 [±0.08] tolerances not to accumulate within one connector pattern.

No. of Pos.	Dimensions		C = .090 [2.29] D = .230 [5.84] E = .185 [4.70]		C = .120 [3.05] D = .230 [5.84] E = .185 [4.70]			C = .110 [2.79] D = .318 [8.08] E = .200 [5.08]		
	A	B	Post Plating/Part Nos.		Plating A	Plating B	Plating C	Post Plating/Part Nos.		
			Plating A	Plating C				Plating A	Plating B	Plating C
2	.084 [2.13]	—	103801-1	103795-1	103149-1	103326-1	103330-1	102979-1	102975-1	103324-1
4	.184 [4.67]	.100 [2.54]	103801-2	103795-2	103149-2	103326-2	103330-2	102979-2	102975-2	103324-2
6	.284 [7.21]	.200 [5.08]	103801-3	103795-3	103149-3	103326-3	103330-3	102979-3	102975-3	103324-3
8	.384 [9.75]	.300 [7.62]	103801-4	103795-4	103149-4	103326-4	103330-4	102979-4	102975-4	103324-4
10	.484 [12.29]	.400 [10.16]	103801-5	103795-5	103149-5	103326-5	103330-5	102979-5	102975-5	103324-5
12	.584 [14.83]	.500 [12.70]	103801-6	103795-6	103149-6	103326-6	103330-6	102979-6	102975-6	103324-6
14	.684 [17.37]	.600 [15.24]	103801-7	103795-7	103149-7	103326-7	103330-7	102979-7	102975-7	103324-7
16	.784 [19.91]	.700 [17.78]	103801-8	103795-8	103149-8	103326-8	103330-8	102979-8	102975-8	103324-8
18	.884 [22.45]	.800 [20.32]	103801-9	103795-9	103149-9	103326-9	103330-9	102979-9	102975-9	103324-9
20	.984 [24.99]	.900 [22.86]	1-103801-0	1-103795-0	1-103149-0	1-103326-0	1-103330-0	1-102979-0	1-102975-0	1-103324-0

Notes: 1. Headers may be broken to desired number of positions using **Tool Kit No. 314818-1** (not shown).
2. Other tail lengths are available, consult Tyco Electronics.

**Breakaway Headers—Unshrouded, Double-Row,
.100 x .100 [2.54 x 2.54] Centerline (Continued)**

No. of Pos.	Dimensions		C = .090 [2.29] D = .230 [5.84] E = .185 [4.70]		C = .120 [3.05] D = .230 [5.84] E = .185 [4.70]			C = .110 [2.79] D = .318 [8.08] E = .200 [5.08]		
	A	B	Post Plating/Part Nos.		Post Plating/Part Nos.			Post Plating/Part Nos.		
			Plating A	Plating C	Plating A	Plating B	Plating C	Plating A	Plating B	Plating C
22	1.084 [27.53]	1.000 [25.40]	1-103801-1	1-103795-1	1-103149-1	1-103326-1	1-103330-1	1-102979-1	1-102975-1	1-103324-1
24	1.184 [30.07]	1.100 [27.94]	1-103801-2	1-103795-2	1-103149-2	1-103326-2	1-103330-2	1-102979-2	1-102975-2	1-103324-2
26	1.284 [32.61]	1.200 [30.48]	1-103801-3	1-103795-3	1-103149-3	1-103326-3	1-103330-3	1-102979-3	1-102975-3	1-103324-3
28	1.384 [35.15]	1.300 [33.02]	1-103801-4	1-103795-4	1-103149-4	1-103326-4	1-103330-4	1-102979-4	1-102975-4	1-103324-4
30	1.484 [37.69]	1.400 [35.56]	1-103801-5	1-103795-5	1-103149-5	1-103326-5	1-103330-5	1-102979-5	1-102975-5	1-103324-5
32	1.584 [40.23]	1.500 [38.10]	1-103801-6	1-103795-6	1-103149-6	1-103326-6	1-103330-6	1-102979-6	1-102975-6	1-103324-6
34	1.684 [42.77]	1.600 [40.64]	1-103801-7	1-103795-7	1-103149-7	1-103326-7	1-103330-7	1-102979-7	1-102975-7	1-103324-7
36	1.784 [45.31]	1.700 [43.18]	1-103801-8	1-103795-8	1-103149-8	1-103326-8	1-103330-8	1-102979-8	1-102975-8	1-103324-8
38	1.884 [47.85]	1.800 [45.72]	1-103801-9	1-103795-9	1-103149-9	1-103326-9	1-103330-9	1-102979-9	1-102975-9	1-103324-9
40	1.984 [50.39]	1.900 [48.26]	2-103801-0	2-103795-0	2-103149-0	2-103326-0	2-103330-0	2-102979-0	2-102975-0	2-103324-0
42	2.084 [52.93]	2.000 [50.80]	2-103801-1	2-103795-1	2-103149-1	2-103326-1	2-103330-1	2-102979-1	2-102975-1	2-103324-1
44	2.184 [55.47]	2.100 [53.34]	2-103801-2	2-103795-2	2-103149-2	2-103326-2	2-103330-2	2-102979-2	2-102975-2	2-103324-2
46	2.284 [58.01]	2.200 [55.88]	2-103801-3	2-103795-3	2-103149-3	2-103326-3	2-103330-3	2-102979-3	2-102975-3	2-103324-3
48	2.384 [60.55]	2.300 [58.42]	2-103801-4	2-103795-4	2-103149-4	2-103326-4	2-103330-4	2-102979-4	2-102975-4	2-103324-4
50	2.484 [63.09]	2.400 [60.96]	2-103801-5	2-103795-5	2-103149-5	2-103326-5	2-103330-5	2-102979-5	2-102975-5	2-103324-5
52	2.584 [65.63]	2.500 [63.50]	2-103801-6	2-103795-6	2-103149-6	2-103326-6	2-103330-6	2-102979-6	2-102975-6	2-103324-6
54	2.684 [68.17]	2.600 [66.04]	2-103801-7	2-103795-7	2-103149-7	2-103326-7	2-103330-7	2-102979-7	2-102975-7	2-103324-7
56	2.784 [70.71]	2.700 [68.58]	2-103801-8	2-103795-8	2-103149-8	2-103326-8	2-103330-8	2-102979-8	2-102975-8	2-103324-8
58	2.884 [73.25]	2.800 [71.12]	2-103801-9	2-103795-9	2-103149-9	2-103326-9	2-103330-9	2-102979-9	2-102975-9	2-103324-9
60	2.984 [75.79]	2.900 [73.66]	3-103801-0	3-103795-0	3-103149-0	3-103326-0	3-103330-0	3-102979-0	3-102975-0	3-103324-0
62	3.084 [78.33]	3.000 [76.20]	3-103801-1	3-103795-1	3-103149-1	3-103326-1	3-103330-1	3-102979-1	3-102975-1	3-103324-1
64	3.184 [80.87]	3.100 [78.74]	3-103801-2	3-103795-2	3-103149-2	3-103326-2	3-103330-2	3-102979-2	3-102975-2	3-103324-2
66	3.284 [83.41]	3.200 [81.28]	3-103801-3	3-103795-3	3-103149-3	3-103326-3	3-103330-3	3-102979-3	3-102975-3	3-103324-3
68	3.384 [85.95]	3.300 [83.82]	3-103801-4	3-103795-4	3-103149-4	3-103326-4	3-103330-4	3-102979-4	3-102975-4	3-103324-4
70	3.484 [88.49]	3.400 [86.36]	3-103801-5	3-103795-5	3-103149-5	3-103326-5	3-103330-5	3-102979-5	3-102975-5	3-103324-5
72	3.584 [91.03]	3.500 [88.90]	3-103801-6	3-103795-6	3-103149-6	3-103326-6	3-103330-6	3-102979-6	3-102975-6	3-103324-6
74	3.684 [93.57]	3.600 [91.44]	3-103801-7	3-103795-7	3-103149-7	3-103326-7	3-103330-7	3-102979-7	3-102975-7	3-103324-7
76	3.784 [96.11]	3.700 [93.98]	3-103801-8	3-103795-8	3-103149-8	3-103326-8	3-103330-8	3-102979-8	3-102975-8	3-103324-8
78	3.884 [98.65]	3.800 [96.52]	3-103801-9	3-103795-9	3-103149-9	3-103326-9	3-103330-9	3-102979-9	3-102975-9	3-103324-9
80	3.984 [101.19]	3.900 [99.06]	4-103801-0	4-103795-0	4-103149-0	4-103326-0	4-103330-0	4-102979-0	4-102975-0	4-103324-0

Notes: 1. Headers may be broken to desired number of positions using **Tool Kit No. 314818-1** (not shown).
2. Other tail lengths are available, consult Tyco Electronics.

.025 [0.64] Square Straight Post (with Board Retention Feature)



Photo 98184-8

Material and Finish:

Housing—Black thermoplastic, 94V-0 rated

Posts—Phosphor bronze, plated as follows:

Plating A—Duplex plated .000030 [0.00076] gold on contact area, .000100-.000200 [0.00254-0.00508] tin-lead on solder area, with entire post underplated .000050 [0.00127] nickel

Plating B—Duplex plated .000015 [0.00038] gold on contact area, .000100-.000200 [0.00254-0.00508] tin-lead on solder area, with entire post underplated .000050 [0.00127] nickel

Plating C—.000100-.000200 [0.00254-0.00508] tin-lead over .000050 [0.00127] nickel on entire post

Performance Characteristics:

Insertion Force—12 lb. [53.4N] maximum

Retention Force—.25 lb. [1.11N] minimum

Related Product Data:

Mateable Connectors—Refer to the Mating Post Selection Guide (page 89)

Technical Documents (page 294):

See mating connector for applicable product and application specifications.

Breakaway Retention Headers—Unshrouded, Single Row, .100 [2.54] Centerline

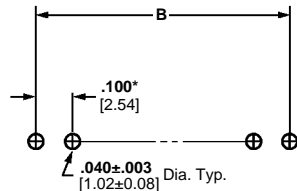
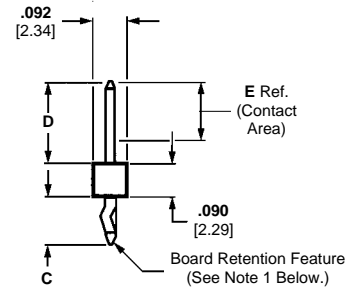
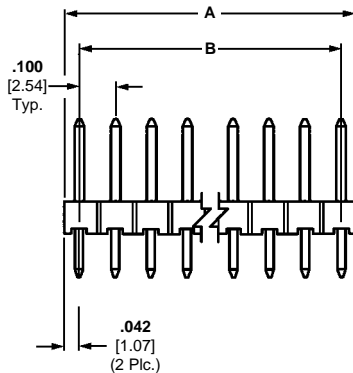

Recommended PC Board Hole Layout (for .055 [1.40] min. thick PC board)

*±.003 [±0.08] tolerances not to accumulate within one connector pattern.

No. of Pos.	Dimensions		C = .120 [3.05] D = .230 [5.84] E = .185 [4.70]			C = .125 [3.18] D = .318 [8.08] E = .200 [5.08]		
	A	B	Post Plating/Part Nos.			Post Plating/Part Nos.		
			Plating A	Plating B	Plating C	Plating A	Plating B	Plating C
3	.284 [7.21]	.200 [5.08]	104344-1	104345-1	104346-1	104426-1	104427-1	104428-1
4	.384 [9.75]	.300 [7.62]	104344-2	104345-2	104346-2	104426-2	104427-2	104428-2
5	.484 [12.29]	.400 [10.16]	104344-3	104345-3	104346-3	104426-3	104427-3	104428-3
6	.584 [14.82]	.500 [12.70]	104344-4	104345-4	104346-4	104426-4	104427-4	104428-4
7	.684 [17.37]	.600 [15.24]	104344-5	104345-5	104346-5	104426-5	104427-5	104428-5
8	.784 [19.91]	.700 [17.78]	104344-6	104345-6	104346-6	104426-6	104427-6	104428-6
9	.884 [22.45]	.800 [20.32]	104344-7	104345-7	104346-7	104426-7	104427-7	104428-7
10	.984 [24.99]	.900 [22.86]	104344-8	104345-8	104346-8	104426-8	104427-8	104428-8
11	1.084 [27.53]	1.000 [25.40]	104344-9	104345-9	104346-9	104426-9	104427-9	104428-9
12	1.184 [30.07]	1.100 [27.94]	1-104344-0	1-104345-0	1-104346-0	1-104426-0	1-104427-0	1-104428-0

Notes: 1. Refer to the product drawing to determine the number and location of the board retention tails.
2. Other tail lengths are available, consult Tyco Electronics.

**Breakaway Retention Headers—Unshrouded, Single Row,
.100 [2.54] Centerline** (Continued)

No. of Pos.	Dimensions		C = .120 [3.05] D = .230 [5.84] E = .185 [4.70]			C = .125 [3.18] D = .318 [8.08] E = .200 [5.08]		
	A	B	Post Plating/Part Nos.			Post Plating/Part Nos.		
			Plating A	Plating B	Plating C	Plating A	Plating B	Plating C
13	1.284 [32.61]	1.200 [30.48]	1-104344-1	1-104345-1	1-104346-1	1-104426-1	1-104427-1	1-104428-1
14	1.384 [35.15]	1.300 [33.02]	1-104344-2	1-104345-2	1-104346-2	1-104426-2	1-104427-2	1-104428-2
15	1.484 [37.69]	1.400 [35.56]	1-104344-3	1-104345-3	1-104346-3	1-104426-3	1-104427-3	1-104428-3
16	1.584 [40.23]	1.500 [38.10]	1-104344-4	1-104345-4	1-104346-4	1-104426-4	1-104427-4	1-104428-4
17	1.684 [42.77]	1.600 [40.64]	1-104344-5	1-104345-5	1-104346-5	1-104426-5	1-104427-5	1-104428-5
18	1.784 [45.31]	1.700 [43.18]	1-104344-6	1-104345-6	1-104346-6	1-104426-6	1-104427-6	1-104428-6
19	1.884 [47.85]	1.800 [45.72]	1-104344-7	1-104345-7	1-104346-7	1-104426-7	1-104427-7	1-104428-7
20	1.984 [50.39]	1.900 [48.26]	1-104344-8	1-104345-8	1-104346-8	1-104426-8	1-104427-8	1-104428-8
21	2.084 [52.93]	2.000 [50.80]	1-104344-9	1-104345-9	1-104346-9	1-104426-9	1-104427-9	1-104428-9
22	2.184 [55.47]	2.100 [53.34]	2-104344-0	2-104345-0	2-104346-0	2-104426-0	2-104427-0	2-104428-0
23	2.284 [58.01]	2.200 [55.88]	2-104344-1	2-104345-1	2-104346-1	2-104426-1	2-104427-1	2-104428-1
24	2.384 [60.55]	2.300 [58.42]	2-104344-2	2-104345-2	2-104346-2	2-104426-2	2-104427-2	2-104428-2
25	2.484 [63.09]	2.400 [60.96]	2-104344-3	2-104345-3	2-104346-3	2-104426-3	2-104427-3	2-104428-3
26	2.584 [65.63]	2.500 [63.50]	2-104344-4	2-104345-4	2-104346-4	2-104426-4	2-104427-4	2-104428-4
30	2.984 [75.79]	2.900 [73.66]	2-104344-5	2-104345-5	2-104346-5	2-104426-5	2-104427-5	2-104428-5
35	3.484 [88.49]	3.400 [86.36]	2-104344-6	2-104345-6	2-104346-6	2-104426-6	2-104427-6	2-104428-6
40	3.984 [101.19]	3.900 [99.06]	2-104344-7	2-104345-7	2-104346-7	2-104426-7	2-104427-7	2-104428-7

Notes: 1. Refer to the product drawing to determine the number and location of the board retention tails.
2. Other tail lengths are available, consult Tyco Electronics.

Breakaway Retention Headers—Unshrouded, Single Row, .100 [2.54] Centerline (Continued)

.025 [0.64] Square Right-Angle Post (with Board Retention Feature)



Photo 98184-1

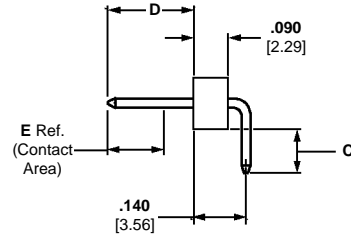
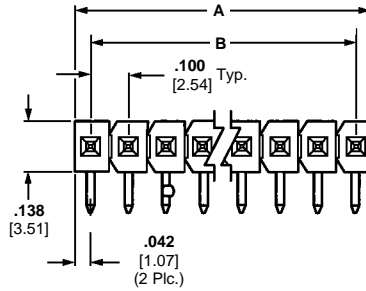

Material and Finish:

Housing—Black thermoplastic, 94V-0 rated

Posts—Phosphor bronze, plated as follows:

Plating A—Duplex plated .000030 [0.00076] gold on contact area, .000100-.000200 [0.00254-0.00508] tin-lead on solder area, with entire post underplated .000050 [0.00127] nickel

Plating B—Duplex plated .000015 [0.00038] gold on contact area, .000100-.000200 [0.00254-0.00508] tin-lead on solder area, with entire post underplated .000050 [0.00127] nickel

Plating C—.000100-.000200 [0.00254-0.00508] tin-lead over .000050 [0.00127] nickel on entire post

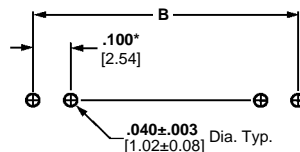

Recommended PC Board Hole Layout (for .055 [1.40] min. thick PC board)

*±.003 [±0.08] tolerances not to accumulate within one connector pattern.

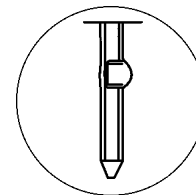

Board Retention using Swaged Tails (All Header Sizes)

Performance Characteristics:

Insertion Force—12 lb. [53.4N] maximum

Retention Force—.25 lb. [1.11N] minimum

Related Product Data:

Mateable Connectors—Refer to the Mating Post Selection Guide (page 89)

Technical Documents (page 294):

See mating connector for applicable product and application specifications.

No. of Pos.	Dimensions		C = .120 [3.05] D = .230 [5.84] E = .185 [4.70]			C = .110 [2.79] D = .318 [8.08] E = .200 [5.08]		
	A	B	Post Plating/Part Nos.			Post Plating/Part Nos.		
			Plating A	Plating B	Plating C	Plating A	Plating B	Plating C
3	.284 [7.21]	.200 [5.08]	104347-1	104348-1	104349-1	104429-1	104430-1	104431-1
4	.384 [9.75]	.300 [7.62]	104347-2	104348-2	104349-2	104429-2	104430-2	104431-2
5	.484 [12.29]	.400 [10.16]	104347-3	104348-3	104349-3	104429-3	104430-3	104431-3
6	.584 [14.83]	.500 [12.70]	104347-4	104348-4	104349-4	104429-4	104430-4	104431-4
7	.684 [17.37]	.600 [15.24]	104347-5	104348-5	104349-5	104429-5	104430-5	104431-5
8	.784 [19.91]	.700 [17.78]	104347-6	104348-6	104349-6	104429-6	104430-6	104431-6
9	.884 [22.45]	.800 [20.32]	104347-7	104348-7	104349-7	104429-7	104430-7	104431-7
10	.984 [24.99]	.900 [22.86]	104347-8	104348-8	104349-8	104429-8	104430-8	104431-8
11	1.084 [27.53]	1.000 [25.40]	104347-9	104348-9	104349-9	104429-9	104430-9	104431-9
12	1.184 [30.07]	1.100 [27.94]	1-104347-0	1-104348-0	1-104349-0	1-104429-0	1-104430-0	1-104431-0

Notes: 1. Refer to the product drawing to determine the number and location of the board retention tails.
2. Other tail lengths are available, consult Tyco Electronics.

**Breakaway Retention Headers—Unshrouded, Single Row,
.100 [2.54] Centerline** (Continued)

No. of Pos.	Dimensions		C = .120 [3.05] D = .230 [5.84] E = .185 [4.70]			C = .110 [2.79] D = .318 [8.08] E = .200 [5.08]		
	A	B	Post Plating/Part Nos.			Post Plating/Part Nos.		
			Plating A	Plating B	Plating C	Plating A	Plating B	Plating C
13	1.284 [32.61]	1.200 [30.48]	1-104347-1	1-104348-1	1-104349-1	1-104429-1	1-104430-1	1-104431-1
14	1.384 [35.15]	1.300 [33.02]	1-104347-2	1-104348-2	1-104349-2	1-104429-2	1-104430-2	1-104431-2
15	1.484 [37.69]	1.400 [35.56]	1-104347-3	1-104348-3	1-104349-3	1-104429-3	1-104430-3	1-104431-3
16	1.584 [40.23]	1.500 [38.10]	1-104347-4	1-104348-4	1-104349-4	1-104429-4	1-104430-4	1-104431-4
17	1.684 [42.77]	1.600 [40.64]	1-104347-5	1-104348-5	1-104349-5	1-104429-5	1-104430-5	1-104431-5
18	1.784 [45.31]	1.700 [43.18]	1-104347-6	1-104348-6	1-104349-6	1-104429-6	1-104430-6	1-104431-6
19	1.884 [47.85]	1.800 [45.72]	1-104347-7	1-104348-7	1-104349-7	1-104429-7	1-104430-7	1-104431-7
20	1.984 [50.39]	1.900 [48.26]	1-104347-8	1-104348-8	1-104349-8	1-104429-8	1-104430-8	1-104431-8
21	2.084 [52.93]	2.000 [50.80]	1-104347-9	1-104348-9	1-104349-9	1-104429-9	1-104430-9	1-104431-9
22	2.184 [55.47]	2.100 [53.34]	2-104347-0	2-104348-0	2-104349-0	2-104429-0	2-104430-0	2-104431-0
23	2.284 [58.01]	2.200 [55.88]	2-104347-1	2-104348-1	2-104349-1	2-104429-1	2-104430-1	2-104431-1
24	2.384 [60.55]	2.300 [58.42]	2-104347-2	2-104348-2	2-104349-2	2-104429-2	2-104430-2	2-104431-2
25	2.484 [63.09]	2.400 [60.96]	2-104347-3	2-104348-3	2-104349-3	2-104429-3	2-104430-3	2-104431-3
26	2.584 [65.63]	2.500 [63.50]	2-104347-4	2-104348-4	2-104349-4	2-104429-4	2-104430-4	2-104431-4
30	2.984 [75.79]	2.900 [73.66]	2-104347-5	2-104348-5	2-104349-5	2-104429-5	2-104430-5	2-104431-5
35	3.484 [88.49]	3.400 [86.36]	2-104347-6	2-104348-6	2-104349-6	2-104429-6	2-104430-6	2-104431-6
40	3.984 [101.19]	3.900 [99.06]	2-104347-7	2-104348-7	2-104349-7	2-104429-7	2-104430-7	2-104431-7

Notes: 1. Refer to the product drawing to determine the number and location of the board retention tails.
2. Other tail lengths are available, consult Tyco Electronics.

Breakaway Retention Headers—Unshrouded, Double Row, .100 x .100 [2.54 x 2.54] Centerline

.025 [0.64] Square Straight Post (with Board Retention Feature)



Photo 98185-7

Material and Finish:

Housing—Black thermoplastic, 94V-0 rated

Posts—Phosphor bronze, plated as follows:

Plating A—Duplex plated .000030 [0.00076] gold on contact area, .000100-.000200 [0.00254-0.00508] tin-lead on solder area, with entire post underplated .000050 [0.00127] nickel

Plating B—Duplex plated .000015 [0.00038] gold on contact area, .000100-.000200 [0.00254-0.00508] tin-lead on solder area, with entire post underplated .000050 [0.00127] nickel

Plating C—.000100-.000200 [0.00254-0.00508] tin-lead over .000050 [0.00127] nickel on entire post

Performance Characteristics:

Insertion Force—12 lb. [53.4N] maximum

Retention Force—.25 lb. [1.11N] minimum

Related Product Data:

Mateable Connectors—Refer to the Mating Post Selection Guide (page 89)

Accessories:

Barrier Insert—page 221

Technical Documents (page 294):

See mating connector for applicable product and application specifications.

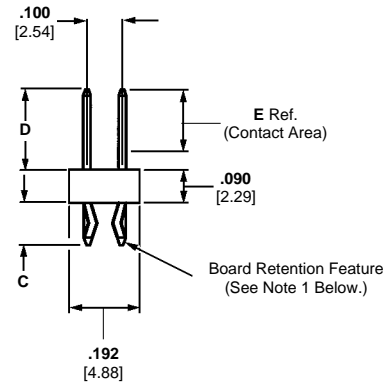
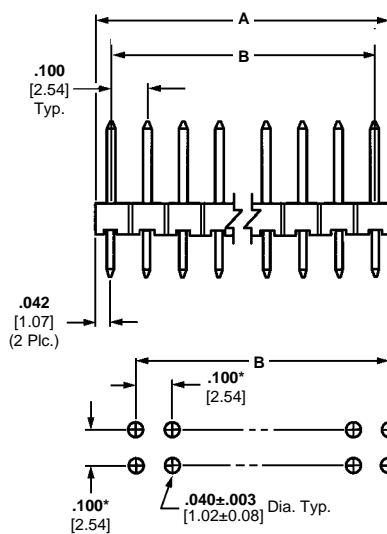

Recommended PC Board Hole Layout (for .055 [1.40] min. thick PC board)

*±.003 [±0.08] tolerances not to accumulate within one connector pattern.

No. of Pos.	Dimensions		C = .120 [3.05] D = .230 [5.84] E = .185 [4.70]			C = .125 [3.18] D = .318 [8.08] E = .200 [5.08]		
	A	B	Post Plating/Part Nos.			Post Plating/Part Nos.		
			Plating A	Plating B	Plating C	Plating A	Plating B	Plating C
2	.084 [2.13]	—	104350-1	104351-1	104352-1	104432-1	104433-1	104434-1
4	.184 [4.67]	.100 [2.54]	104350-2	104351-2	104352-2	104432-2	104433-2	104434-2
6	.284 [7.21]	.200 [5.08]	104350-3	104351-3	104352-3	104432-3	104433-3	104434-3
8	.384 [9.75]	.300 [7.62]	104350-4	104351-4	104352-4	104432-4	104433-4	104434-4
10	.484 [12.29]	.400 [10.16]	104350-5	104351-5	104352-5	104432-5	104433-5	104434-5
12	.584 [14.83]	.500 [12.70]	104350-6	104351-6	104352-6	104432-6	104433-6	104434-6
14	.684 [17.37]	.600 [15.24]	104350-7	104351-7	104352-7	104432-7	104433-7	104434-7
16	.784 [19.91]	.700 [17.78]	104350-8	104351-8	104352-8	104432-8	104433-8	104434-8
18	.884 [22.45]	.800 [20.32]	104350-9	104351-9	104352-9	104432-9	104433-9	104434-9
20	.984 [24.99]	.900 [22.86]	1-104350-0	1-104351-0	1-104352-0	1-104432-0	1-104433-0	1-104434-0
22	1.084 [27.53]	1.000 [25.40]	1-104350-1	1-104351-1	1-104352-1	1-104432-1	1-104433-1	1-104434-1
24	1.184 [30.07]	1.100 [27.94]	1-104350-2	1-104351-2	1-104352-2	1-104432-2	1-104433-2	1-104434-2
26	1.284 [32.61]	1.200 [30.48]	1-104350-3	1-104351-3	1-104352-3	1-104432-3	1-104433-3	1-104434-3
28	1.384 [35.15]	1.300 [33.02]	1-104350-4	1-104351-4	1-104352-4	1-104432-4	1-104433-4	1-104434-4
30	1.484 [37.69]	1.400 [35.56]	1-104350-5	1-104351-5	1-104352-5	1-104432-5	1-104433-5	1-104434-5
34	1.684 [42.77]	1.600 [40.64]	1-104350-6	1-104351-6	1-104352-6	1-104432-6	1-104433-6	1-104434-6
40	1.984 [50.39]	1.900 [48.26]	1-104350-7	1-104351-7	1-104352-7	1-104432-7	1-104433-7	1-104434-7
50	2.484 [63.09]	2.400 [60.96]	1-104350-8	1-104351-8	1-104352-8	1-104432-8	1-104433-8	1-104434-8
60	2.984 [75.79]	2.900 [73.66]	1-104350-9	1-104351-9	1-104352-9	1-104432-9	1-104433-9	1-104434-9
80	3.984 [101.19]	3.900 [99.06]	2-104350-0	2-104351-0	2-104352-0	2-104432-0	2-104433-0	2-104434-0

Notes: 1. Refer to the product drawing to determine the number and location of the board retention tails.
2. Other tail lengths are available, consult Tyco Electronics.

Breakaway Retention Headers—Unshrouded, Double Row, .100 x .100 [2.54 x 2.54] Centerline (Continued)

.025 [0.64] Square Right-Angle Post (with Board Retention Feature)



Photo 98184-4

Material and Finish:

Housing—Black thermoplastic, 94V-0 rated

Posts—Phosphor bronze, plated as follows:

Plating A—Duplex plated .000030 [0.00076] gold on contact area, .000100-.000200 [0.00254-0.00508] tin-lead on solder area, with entire post unplated. .000050 [0.00127] nickel

Plating B—Duplex plated .000015 [0.00038] gold on contact area, .000100-.000200 [0.00254-0.00508] tin-lead on solder area, with entire post unplated. .000050 [0.00127] nickel

Plating C—.000100-.000200 [0.00254-0.00508] tin-lead over .000050 [0.00127] nickel on entire post

Performance Characteristics:

Insertion Force—12 lb. [53.4N] maximum

Retention Force—.25 lb. [1.11N] minimum

Related Product Data:

Mateable Connectors—Refer to the Mating Post Selection Guide (page 89)

Technical Documents (page 294):

See mating connector for applicable product and application specifications.

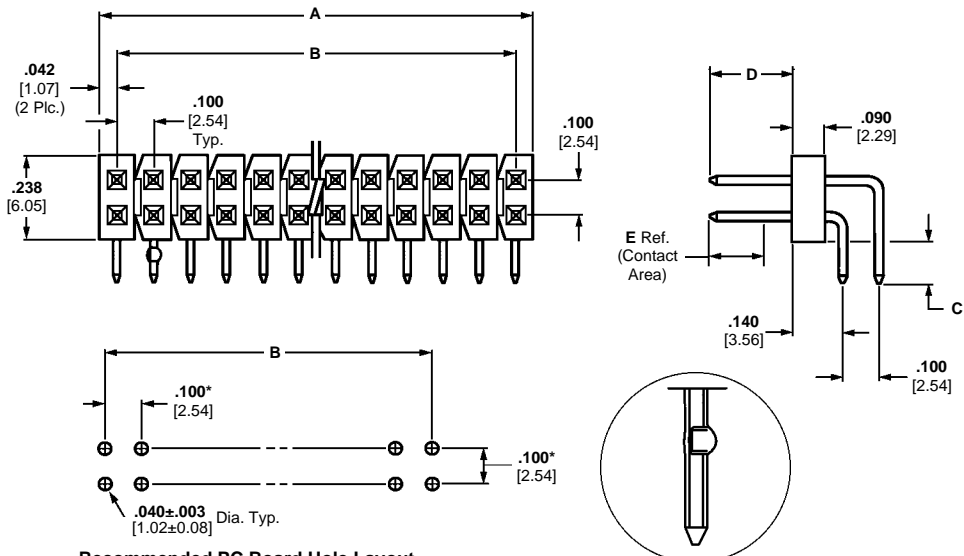

Recommended PC Board Hole Layout (for .055 [1.40] min. thick PC board)

*±.003 [±0.08] tolerances not to accumulate within one connector pattern.

Board Retention using Swaged Tails (All Header Sizes)

No. of Pos.	Dimensions		C = .120 [3.05] D = .230 [5.84] E = .185 [4.70]			C = .110 [2.79] D = .318 [8.08] E = .200 [5.08]		
	A	B	Post Plating/Part Nos.			Post Plating/Part Nos.		
			Plating A	Plating B	Plating C	Plating A	Plating B	Plating C
2	.084 [2.13]	—	104353-1	104354-1	104355-1	104435-1	104436-1	104437-1
4	.184 [4.67]	.100 [2.54]	104353-2	104354-2	104355-2	104435-2	104436-2	104437-2
6	.284 [7.21]	.200 [5.08]	104353-3	104354-3	104355-3	104435-3	104436-3	104437-3
8	.384 [9.75]	.300 [7.62]	104353-4	104354-4	104355-4	104435-4	104436-4	104437-4
10	.484 [12.29]	.400 [10.16]	104353-5	104354-5	104355-5	104435-5	104436-5	104437-5
12	.584 [14.83]	.500 [12.70]	104353-6	104354-6	104355-6	104435-6	104436-6	104437-6
14	.684 [17.37]	.600 [15.24]	104353-7	104354-7	104355-7	104435-7	104436-7	104437-7
16	.784 [19.91]	.700 [17.78]	104353-8	104354-8	104355-8	104435-8	104436-8	104437-8
18	.884 [22.45]	.800 [20.32]	104353-9	104354-9	104355-9	104435-9	104436-9	104437-9
20	.984 [24.99]	.900 [22.86]	1-104353-0	1-104354-0	1-104355-0	1-104435-0	1-104436-0	1-104437-0
22	1.084 [27.53]	1.000 [25.40]	1-104353-1	1-104354-1	1-104355-1	1-104435-1	1-104436-1	1-104437-1
24	1.184 [30.07]	1.100 [27.94]	1-104353-2	1-104354-2	1-104355-2	1-104435-2	1-104436-2	1-104437-2
26	1.284 [32.61]	1.200 [30.48]	1-104353-3	1-104354-3	1-104355-3	1-104435-3	1-104436-3	1-104437-3
28	1.384 [35.15]	1.300 [33.02]	1-104353-4	1-104354-4	1-104355-4	1-104435-4	1-104436-4	1-104437-4
30	1.484 [37.69]	1.400 [35.56]	1-104353-5	1-104354-5	1-104355-5	1-104435-5	1-104436-5	1-104437-5
34	1.684 [42.77]	1.600 [40.64]	1-104353-6	1-104354-6	1-104355-6	1-104435-6	1-104436-6	1-104437-6
40	1.984 [50.39]	1.900 [48.26]	1-104353-7	1-104354-7	1-104355-7	1-104435-7	1-104436-7	1-104437-7
50	2.484 [63.09]	2.400 [60.96]	1-104353-8	1-104354-8	1-104355-8	1-104435-8	1-104436-8	1-104437-8
60	2.984 [75.79]	2.900 [73.66]	1-104353-9	1-104354-9	1-104355-9	1-104435-9	1-104436-9	1-104437-9
80	3.984 [101.19]	3.900 [99.06]	2-104353-0	2-104354-0	2-104355-0	2-104435-0	2-104436-0	2-104437-0

- Notes:** 1. Refer to the product drawing to determine the number and location of the board retention tails.
2. Other tail lengths are available, consult Tyco Electronics.

Breakaway and Retention Headers-Unshrouded

5

AMPMODU Reeled Breakaway Headers

Features of Breakaway Headers

- Design and inventory versatility - headers can easily be made into any size
- High Temperature Compatible
- Reduced part number base
- Reduced inventory burden

Applications

- Desktops & workstations
- Set-top boxes
- Televisions
- Automotive instrument panels & radios
- Medical and test equipment

Benefits

- Off the shelf availability
- Various header length capability using the same reel
- Reduction of inventory costs
- Economy version of the standard breakaway headers

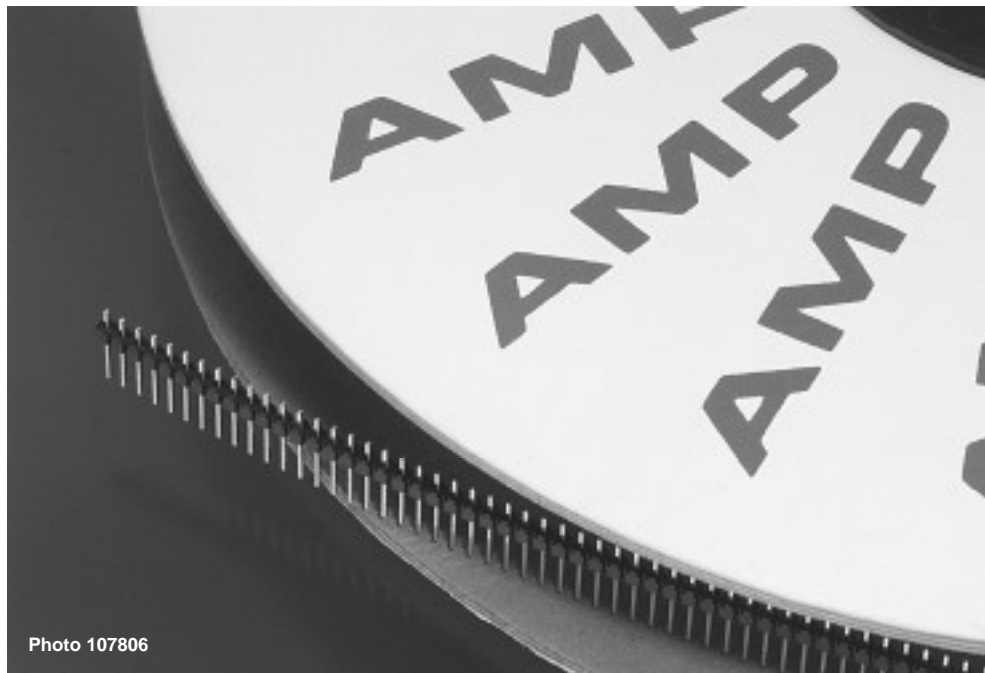

Photo 107806

Tyco Electronics now offers AMPMODU reeled breakaway headers, which are used for board-to-board interconnections, on a continuous reel. The reeled breakaway headers are an economy version of the standard breakaway headers, and continue to provide the same high quality standards that Tyco Electronics is known for in the connector industry.

Reeled breakaway headers provide the flexibility to be able to cut the headers to many different lengths, while only having to stock one part number. As a result, the amount of part numbers that need to be purchased and stored can be greatly reduced.

Reeled breakaway headers can be purchased in single and double rows with tin-lead, 5 Au, 15 Au, and 30 Au duplex plating. The lower applied cost also offers .230" and .318" mating lengths. (See standard breakaway-to-reeled header conversion chart for vertical headers on the reverse side of this sheet)

Potential industries include: computer peripherals, telecommunications equipment, consumer, automotive, medical and test equipment.

Tooling available from: Robo-Pak, Inc. 814 Lakeshore Drive East Bethel, MN 55902

A pin retention and pin removal tooling option is also available in addition to cutting.

AMPMODU Reeled Breakaway Headers (Continued)

Single Row

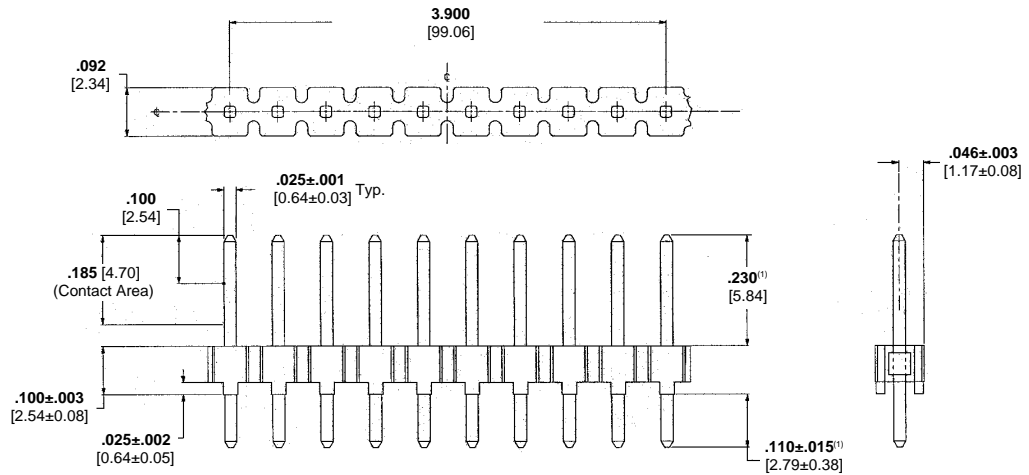

Double Row

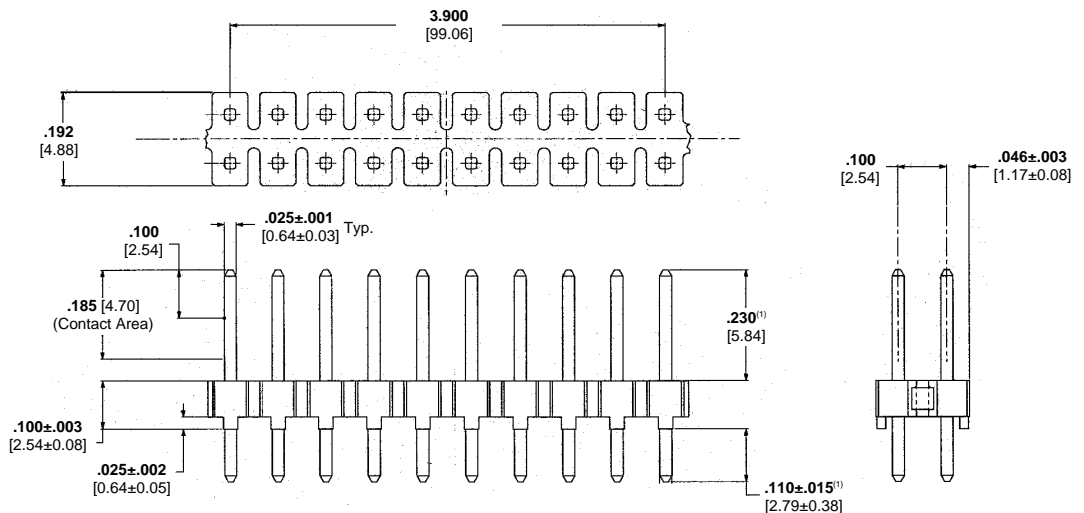

(1) See table for other mate and tail lengths.

Standard Breakaway-to-Reeled Header Conversion Chart (Vertical)

Plating Options	Double Row Headers				Single Row Headers			
	Existing Tyco Electronics P/N	Make From Reeled P/N	Existing Tyco Electronics P/N	Make From Reeled P/N	Existing Tyco Electronics P/N	Make From Reeled P/N	Existing Tyco Electronics P/N	Make From Reeled P/N
	Mate: .318 Tail: .125	Mate: .318 Tail: .115	Mate: .230 Tail: .120	Mate: .230 Tail: .110	Mate: .318 Tail: .125	Mate: .318 Tail: .115	Mate: .230 Tail: .120	Mate: .230 Tail: .110
Tin-Lead	103322	146853-1	103328	146851-1	103321	146852-1	103327	146850-1
15 Au Duplex	146250	146853-1	146254	146851-1	146274	146852-1	146278	146850-1
	102973	146861-1	103186	146859-1	102972	146860-1	103185	146858-1
30 Au Duplex	146252	146861-1	146256	146859-1	146276	146860-1	146280	146858-1
	102977	146871-1	103240	146869-1	102976	146870-1	103239	146868-1
	146253	146871-1	146257	146869-1	146277	146870-1	146281	146868-1

* Note: Reeled Headers are a functional substitute for standard breakaways, however there are visual differences (i.e. housing appearance and bow due to reeling requirement).

Reeled Breakaway Headers

5

Breakaway Surface-Mount Compatible, High Temperature Headers—Unshrouded

Product Facts

- Variety of popular sizes available
- Substantial time/labor savings—install all posts at one time
- Vertical and right-angle versions available in single- and double-row configurations
- Phosphor bronze posts
- Gold duplex and tin plated posts
- Post lengths include .230 [5.84] and .318 [8.08] for connector mating
- Black, glass-filled thermoplastic housings, high temperature compatible
- Recognized under the Component Program of Underwriters Laboratories Inc., File No. E28476
- Certified by Canadian Standards Association, File No. LR 7189

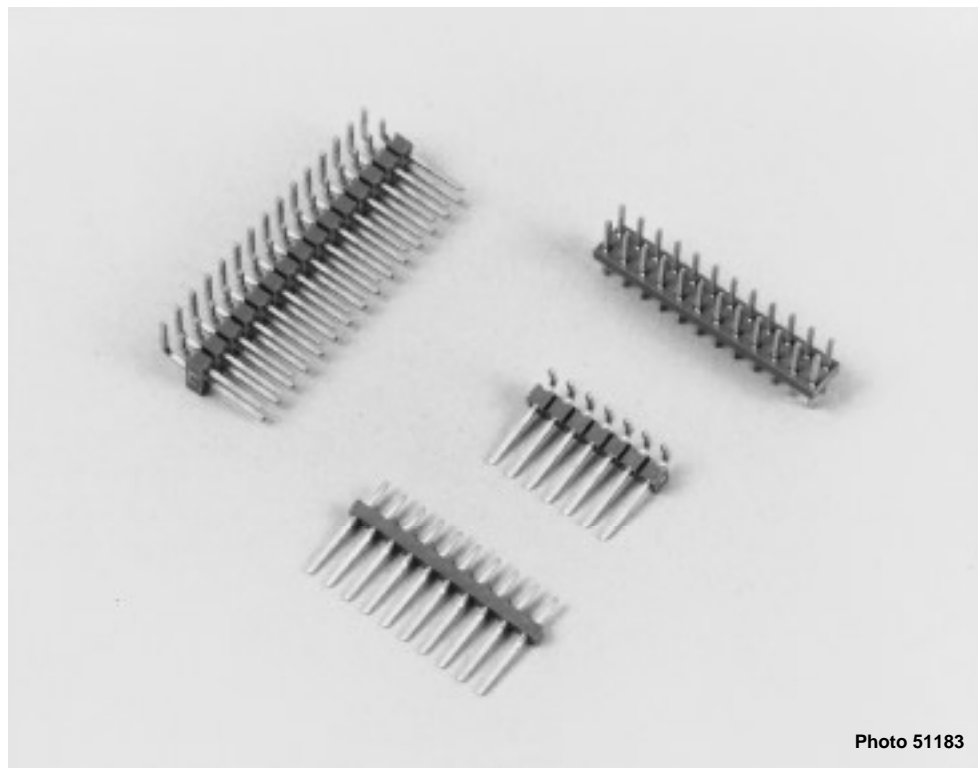

Photo 51183

The AMPMODU interconnection system provides interconnections with a unique modular concept.

AMPMODU mating posts are supplied typically as header assemblies. They are available in various populations to meet the interconnection and packaging requirements of your system.

Performance Characteristics

Electrical:

- Insulation Resistance**—5,000 megohms minimum initial
- Dielectric Withstanding Voltage**—750 V rms at sea level
- Current**—3 amperes maximum per single contact (dependent upon mating receptacle)

Environmental:

- Operating Temperature**—-65°C to +105°C

Breakaway Surface-Mount Compatible, High Temperature Headers—Unshrouded, Single-Row, .100 [2.54] Centerline with Special Stand-offs

.025 [0.64] Square Straight Posts



Material and Finish:

Housing—Black thermoplastic, 94V-0 rated, high temperature compatible

Posts—Phosphor bronze, plated as follows:

Plating A—Duplex plated .000030 [0.00076] gold on contact area, .000100-.000200 [0.00254-0.00508] tin-lead on solder tail, with entire post underplated .000050 [0.00127] nickel

Plating B—Duplex plated .000015 [0.00038] gold on contact area, .000100-.000200 [0.00254-0.00508] tin-lead on solder tail, with entire post underplated .000050 [0.00127] nickel

Plating C—.000100-.000200 [0.00254-0.00508] tin-lead over .000050 [0.00127] nickel

Performance Characteristics (Board Retention Tails):

Insertion Force—12 lb [53.4N] Max.

Retention Force—25 lb [1.11N] Min.

Related Product Data:

Mateable Connectors—Refer to the Mating Post Selection Guide (page 89)

Technical Documents (page 294):

See mating connector for applicable product and application specifications.

Headers with Solder Tails

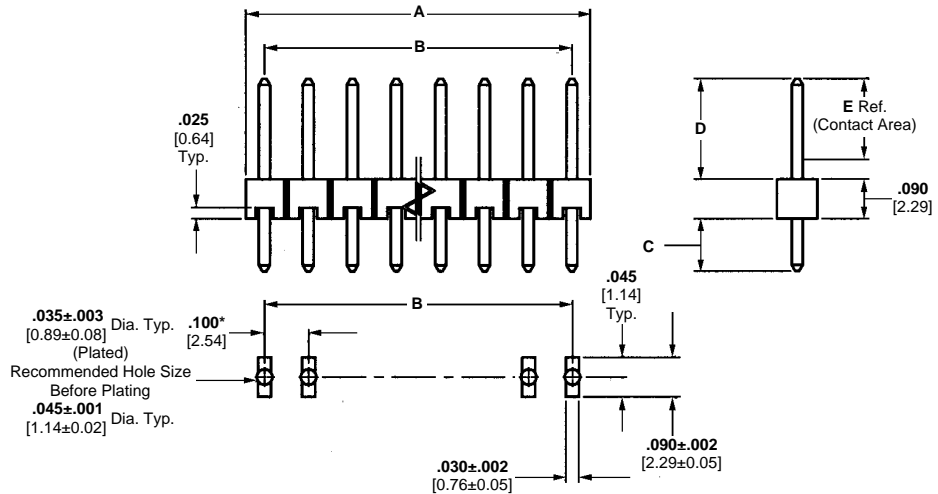

Recommended PC Board Mounting Pattern (for .062 [1.57] thick PC board; .008 [.203] thick stencil)
*±.003 [±0.08] tolerances not to accumulate within one connector pattern.

Headers with Board Retention Tails

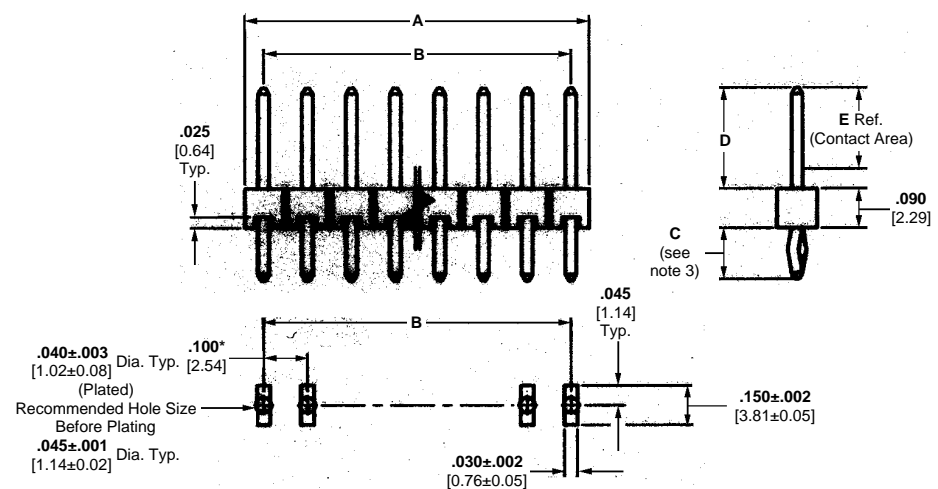

Recommended PC Board Mounting Pattern (for .062 [1.57] thick PC board; .008 [.203] thick stencil)
*±.003 [±0.08] tolerances not to accumulate within one connector pattern.

Header Style	No. of Pos.	Dimensions		C = .090 [2.29] D = .230 [5.84] E = .185 [4.70]			C = .120 [3.05] D = .230 [5.84] E = .185 [4.70]			C = .125 [3.18] D = .318 [8.08] E = .200 [5.08]		
		A	B	Post Plating/Part Nos.			Post Plating/Part Nos.			Post Plating/Part Nos.		
				Plating A	Plating B	Plating C	Plating A	Plating B	Plating C	Plating A	Plating B	Plating C
With Solder Tails (See Notes 1 and 2.)	1	.084 [2.13]	—	146285-1	146284-1	146282-1	146281-1	146280-1	146278-1	146277-1	146276-1	146274-1
	40	3.984 [101.19]	3.900 [99.06]	4-146285-0	4-146284-0	4-146282-0	4-146281-0	4-146280-0	4-146278-0	4-146277-0	4-146276-0	4-146274-0
With Board Retention Tails (See Notes 2 and 3.)	3	.284 [7.21]	.200 [5.08]	146297-3	146296-3	146294-3	146293-3	146292-3	146290-3	146289-3	146288-3	146286-3
	40	3.984 [101.19]	3.900 [99.06]	4-146297-0	4-146296-0	4-146294-0	4-146293-0	4-146292-0	4-146290-0	4-146289-0	4-146288-0	4-146286-0

- Notes:**
1. Headers without retention tails may be broken to the desired number of positions using **Tool Kit No. 314818-1** (not shown).
 2. Headers are also available in sizes 2 thru 39 positions (with Solder Tails) and 4 thru 39 positions (with Board Retention Tails). When ordering, add the prefix and/or suffix (dash) numbers to the base part number that corresponds with the desired size. For example, the complete part number for an 8-position header with solder tails (C dimension .090 [2.29], post plating A) would be 146285-8. The complete part number for a 26-position header with board retention tails (C dimension .120 [3.05], post plating B) would be 2-146292-6. This part numbering system applies only to this page.
 3. For C dimensions .120 [3.05] and .125 [3.18], board retention using kinked tails are for headers 6 positions and smaller; headers 7 positions and larger use swaged tails. Headers with a C dimension of .090 [2.29] have swaged tails for all sizes.

**Breakaway Surface-Mount Compatible, High Temperature Headers—
Unshrouded, Single-Row, .100 [2.54] Centerline**

**.025 [0.64] Square
Right-Angle Posts**



Material and Finish:

Housing—Black thermoplastic, 94V-0 rated, high temperature compatible

Posts—Phosphor bronze, duplex plated .000030 [0.00076] gold on contact area, .000100-.000200 [0.00254-0.00508] matte tin-lead on solder tail, with entire post underplated .000050 [0.00127] nickel

**Performance Characteristics
(Board Retention Tails):**

Insertion Force—12 lb [53.4N] Max.

Retention Force—25 lb [1.11N] Min.

Related Product Data:

Mateable Connectors—Refer to the Mating Post Selection Guide (page 89)

Technical Documents (page 294):

See mating connector for applicable product and application specifications.

Headers with Solder Tails

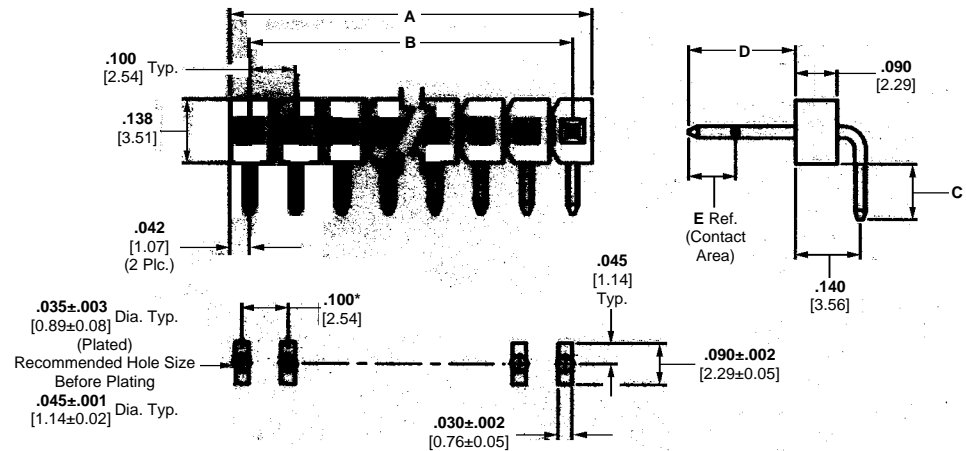

**Recommended PC Board Mounting Pattern
(for .062 [1.57] thick PC board; .008 [.203] thick stencil)**

*±.003 [±0.08] tolerances not to accumulate within one connector pattern.

Headers with Board Retention Tails

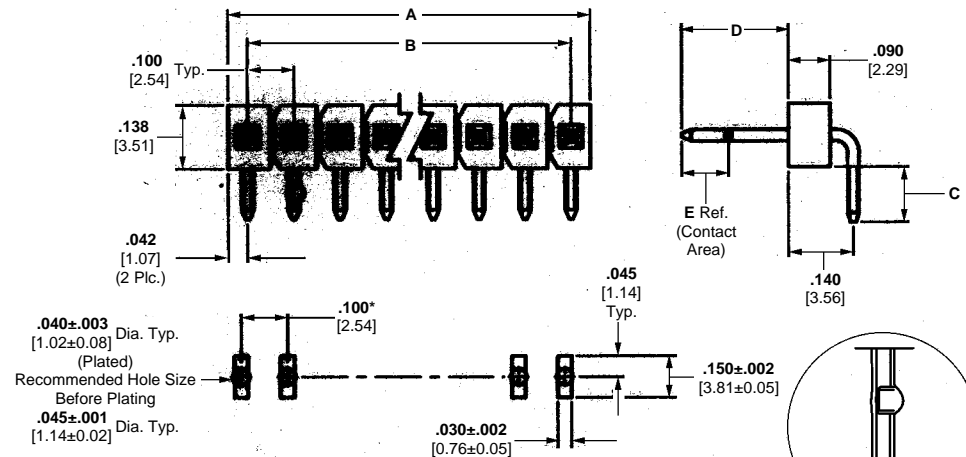

**Recommended PC Board Mounting Pattern
(for .062 [1.57] thick PC board; .008 [.203] thick stencil)**

*±.003 [±0.08] tolerances not to accumulate within one connector pattern.

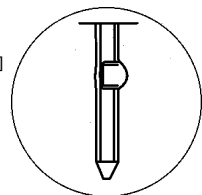

**Board Retention
using Swaged Tails
(All Header Sizes)**

Header Style	No. of Pos.	Dimensions		Part Nos.	
		A	B	C = .120 [3.05] D = .230 [5.84] E = .185 [4.70]	C = .110 [2.79] D = .318 [8.08] E = .200 [5.08]
With Solder Tails (See Notes 1 and 2.)	1	.084 [2.13]	—	146304-1	146305-1
	40	3.984 [101.19]	3.900 [99.06]	4-146304-0	4-146305-0
With Board Retention Tails (See Note 2.)	1	.084 [2.13]	—	146306-1	146307-1
	40	3.984 [101.19]	3.900 [99.06]	4-146306-0	4-146307-0

Notes: 1. Headers without retention tails may be broken to the desired number of positions using **Tool Kit No. 314818-1 (not shown)**.
2. Headers are also available in sizes 2 thru 39 positions (with Solder Tails) and 4 thru 39 positions (with Board Retention Tails).
When ordering, add the prefix and/or suffix (dash) numbers to the base part number that corresponds with the number of positions. For example, the complete part number for an 8-position header with solder tails (C dimension .120 [3.05]) would be 146304-8. The complete part number for a 26-position header with board retention tails (C dimension .120 [3.05]) would be 2-146306-6. This part numbering system applies only to this page.

Breakaway Surface-Mount Compatible, High Temperature Headers— Unshrouded, Double-Row, .100 [2.54] Centerline with Special Stand-offs

.025 [0.64] Square Straight Posts



Material and Finish:

Housing—Black thermoplastic, 94V-0 rated, high temperature compatible

Posts—Phosphor bronze, plated as follows:

Plating A—Duplex plated .000030 [0.00076] gold on contact area, .000100-.000200 [0.00254-0.00508] tin-lead on solder tail, with entire post underplated .000050 [0.00127] nickel

Plating B—Duplex plated .000015 [0.00038] gold on contact area, .000100-.000200 [0.00254-0.00508] tin-lead on solder tail, with entire post underplated .000050 [0.00127] nickel

Plating C—.000100-.000200 [0.00254-0.00508] tin-lead over .000050 [0.00127] nickel

Performance Characteristics (Board Retention Tails):

Insertion Force—12 lb [53.4N] Max.

Retention Force—25 lb [1.11N] Min.

Related Product Data:

Mateable Connectors—Refer to the Mating Post Selection Guide (page 89)

Technical Documents (page 294):

See mating connector for applicable product and application specifications.

Headers with Solder Tails

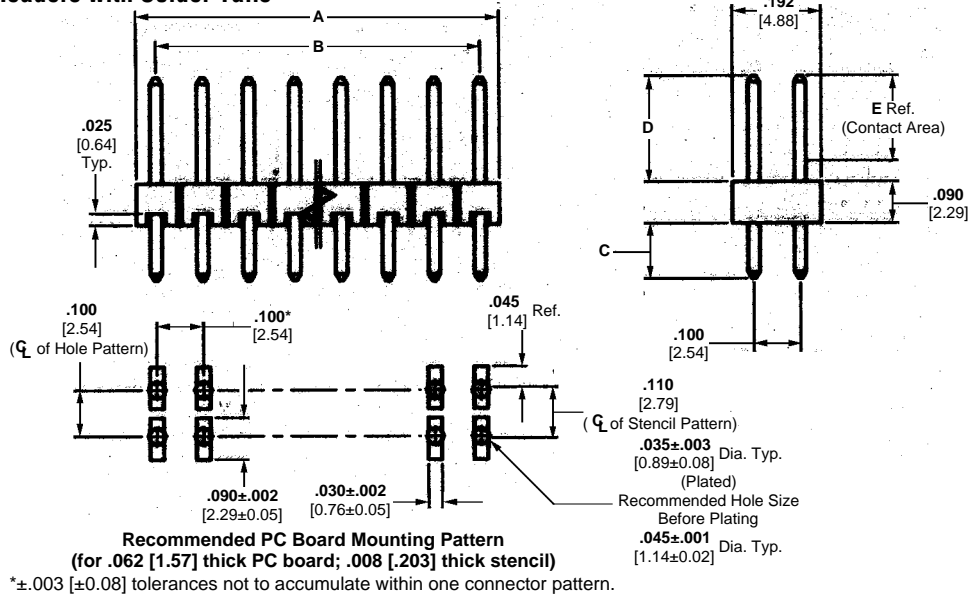

Headers with Board Retention Tails

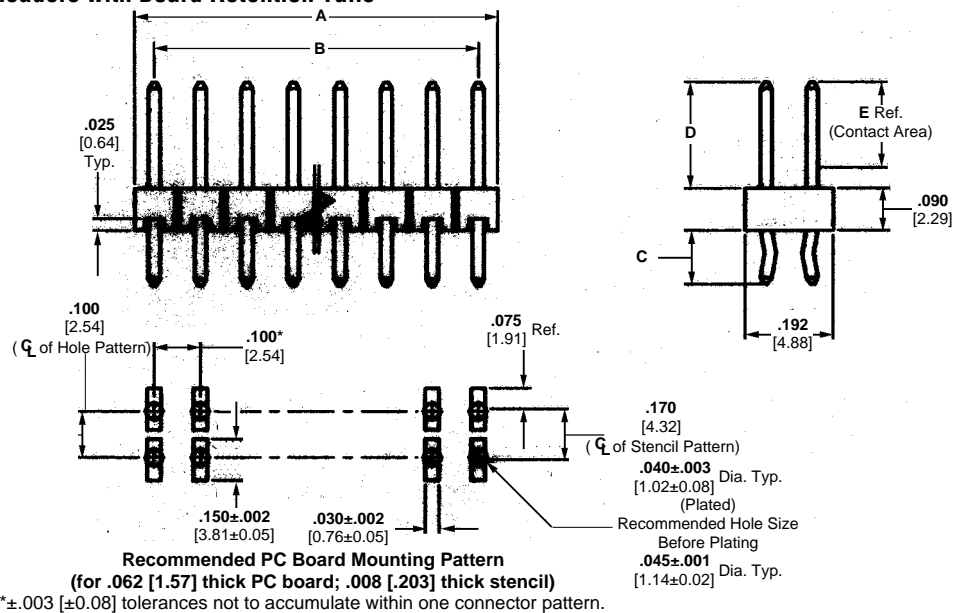

Header Style	No. of Pos.	Dimensions		C = .090 [2.29] D = .230 [5.84] E = .185 [4.70]			C = .120 [3.05] D = .230 [5.84] E = .185 [4.70]			C = .125 [3.18] D = .318 [8.08] E = .200 [5.08]		
		A	B	Post Plating/Part Nos.			Post Plating/Part Nos.			Post Plating/Part Nos.		
				Plating A	Plating B	Plating C	Plating A	Plating B	Plating C	Plating A	Plating B	Plating C
With Solder Tails (See Notes 1 and 2.)	2	.084 [2.13]	—	146261-1	146260-1	146258-1	146257-1	146256-1	146254-1	146253-1	146252-1	146250-1
	80	3.984 [101.19]	3.900 [99.06]	4-146261-0	4-146260-0	4-146258-0	4-146257-0	4-146256-0	4-146254-0	4-146253-0	4-146252-0	4-146250-0
With Board Retention Tails (See Note 2.)	2	.084 [2.13]	—	146273-1	146272-1	146270-1	146269-1	146268-1	146266-1	146265-1	146264-1	146262-1
	80	3.984 [101.19]	3.900 [99.06]	4-146273-0	4-146272-0	4-146270-0	4-146269-0	4-146268-0	4-146266-0	4-146265-0	4-146264-0	4-146262-0

Notes: 1. Headers without retention tails may be broken to the desired number of positions using **Tool Kit No. 314818-1** (not shown).
2. Headers are also available in sizes 4 thru 78 positions. When ordering, add the prefix and/or suffix (dash) numbers to the base part number that corresponds with the number of positions per row. For example, the complete part number for a 16-position header with solder tails (C dimension .090 [2.29], post plating A) would be 146261-8. The complete part number for a 40-position header with board retention tails (C dimension .120 [3.05], post plating B) would be 2-146268-0. This part numbering system applies only to this page.

**Breakaway Surface-Mount Compatible, High Temperature Headers—
Unshrouded, Double-Row, .100 [2.54] Centerline**

**.025 [0.64] Square
Right-Angle Posts**



Material and Finish:

Housing—Black thermoplastic, 94V-0 rated, high temperature compatible

Posts—Phosphor bronze, duplex plated .000030 [0.00076] gold on contact area, .000100-.000200 [0.00254-0.00508] matte tin-lead on solder tail, with entire post underplated .000050 [0.00127] nickel

**Performance Characteristics
(Board Retention Tails):**

Insertion Force—12 lb [53.4N] Max.

Retention Force—.25 lb [1.11N] Min.

Related Product Data:

Mateable Connectors—Refer to the Mating Post Selection Guide (page 89)

Technical Documents (page 294):

See mating connector for applicable product and application specifications.

Headers with Solder Tails

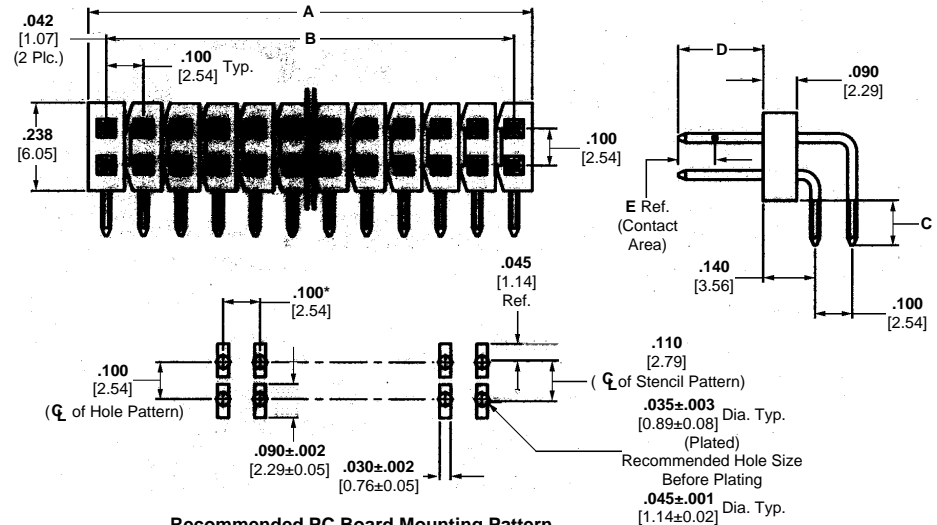

Recommended PC Board Mounting Pattern
(for .062 [1.57] thick PC board; .008 [.203] thick stencil)
*±.003 [±0.08] tolerances not to accumulate within one connector pattern.

Headers with Board Retention Tails

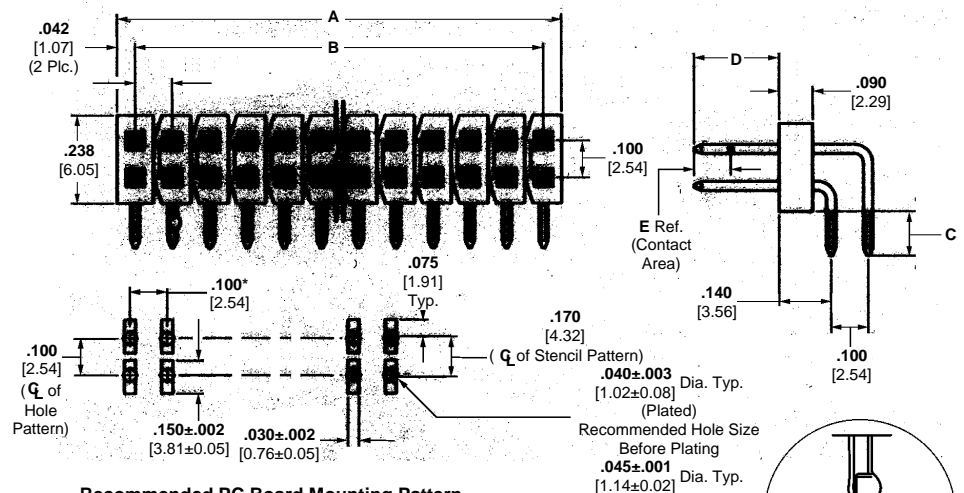

Recommended PC Board Mounting Pattern
(for .062 [1.57] thick PC board; .008 [.203] thick stencil)
*±.003 [±0.08] tolerances not to accumulate within one connector pattern.

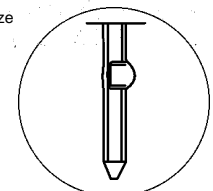

**Board Retention
using Swaged Tails
(All Header Sizes)**

Header Style	No. of Pos.	Dimensions		Part Nos.	
		A	B	C = .120 [3.05] D = .230 [5.84] E = .185 [4.70]	C = .110 [2.79] D = .318 [8.08] E = .200 [5.08]
With Solder Tails (See Notes 1 and 2.)	2	.084 [2.13]	—	146308-1	146309-1
	80	3.984 [101.19]	3.900 [99.06]	4-146308-0	4-146309-0
With Board Retention Tails (See Note 2.)	2	.084 [2.13]	—	146310-1	146311-1
	80	3.984 [101.19]	3.900 [99.06]	4-146310-0	4-146311-0

Notes: 1. Headers without retention tails may be broken to the desired number of positions using **Tool Kit No. 314818-1** (not shown).
2. Headers are also available in sizes 4 thru 78 positions. When ordering, add the prefix and/or suffix (dash) numbers to the base part number that corresponds with the number of positions per row. For example, the complete part number for a 16-position header with solder tails (C dimension .120 [3.05]) would be 146308-8. The complete part number for a 40-position header with board retention tails (C dimension .120 [3.05]) would be 2-146310-0. This part numbering system applies only to this page.

Breakaway Surface Mount Headers, .100 x .100 [2.54 x 2.54] Centerline

Product Facts

- Surface Mount Leads
- Contact Material: phosphor bronze
- High temperature, black thermoplastic housings, 94V-0 rated, capable of withstanding IR or vapor-phase reflow
- Recognized under the Component Program of Underwriters Laboratories Inc. File No. E28476 
- Certified by Canadian Standards Association, File No. LR 7189 
- Choice of gold duplex or tin lead plated posts
- Posts coplanar within .006 [0.15]
- Tape and reel packaging available in addition to single tube packaging. Contact Tyco Electronics.
- Pick-and-place cap available for vacuum placement. Contact Tyco Electronics.

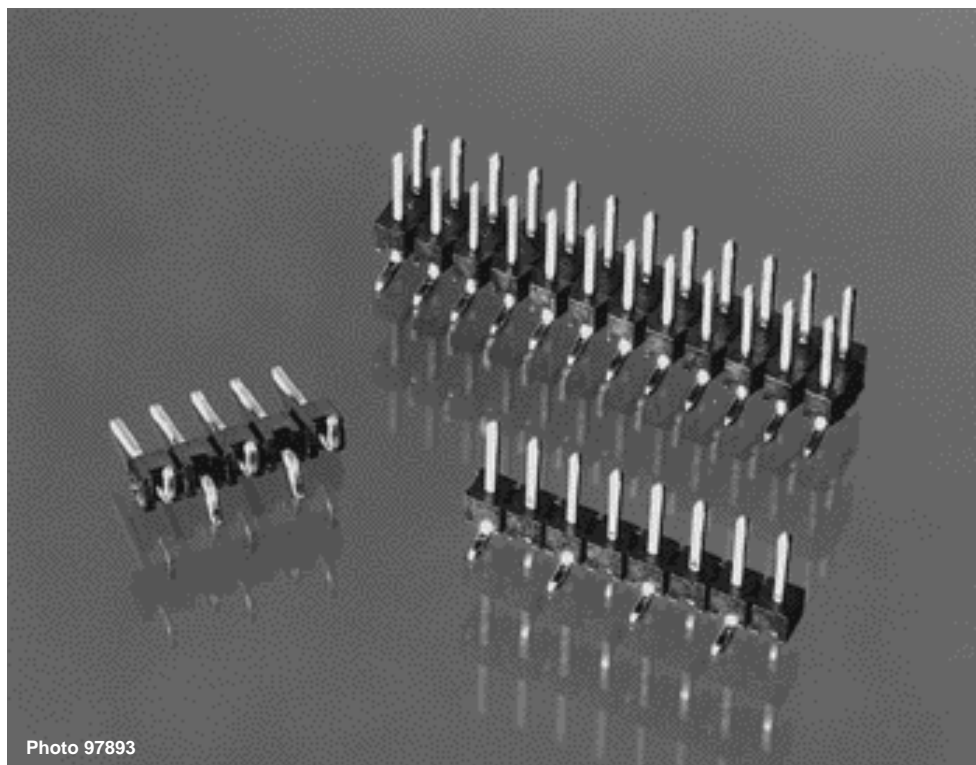

Photo 97893

An extension of the AMPMODU Breakaway Header product family is the surface mount, vertical breakaway headers. The AMPMODU surface-mount breakaway headers (Unshrouded) are available

in single- and double-row vertical configurations with mating lengths of .230 [5.84] and .320 [8.13]. Posts are offered with a choice of either .000030 [.0007] gold duplex or tin lead plating.

Current packaging is in a single tube but tape and reel is available for automatic pick-and-place. We also can provide a pick-and-place cap for vacuum placement if required.

**Breakaway Surface-Mount Headers—Unshrouded
Single-Row, .100 [2.54] Centerline**

**.025 [0.64] Square
Straight Post**

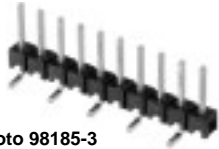

Photo 98185-3

Material and Finish:

Housing—Black thermoplastic, 94V-0 rated, high temperature compatible

Posts—Phosphor bronze, plated as follows:

Plating A—Duplex plated .000030 [0.00076] gold on contact area, .000100-.000200 [0.00254-0.00508] tin-lead on solder area, with entire post underplated .000050 [0.00127] nickel

Plating B—.000100-.000200 [0.00254-0.00508] tin-lead over .000050 [0.00127] nickel entire post

Related Product Data:

Mateable Receptacle—Refer to Mating Post Selection Guide (page 89)

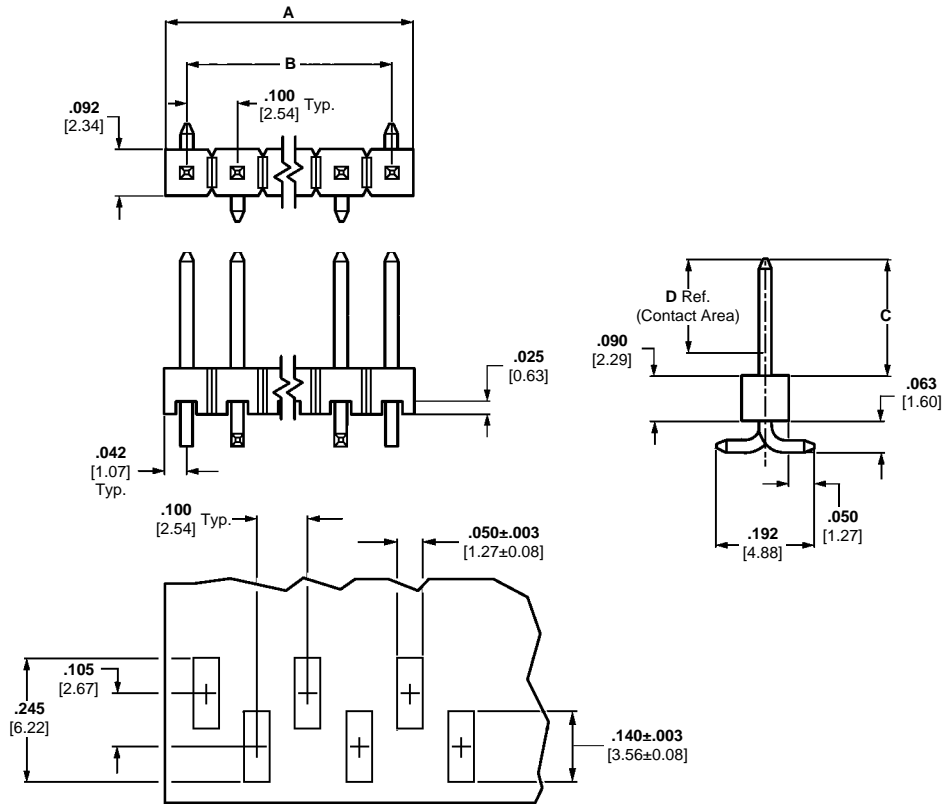

**Recommended Etched Circuit Layout
(Using .008 [0.20] thick stencil)**

Technical Documents (page 294):

See mating connector for applicable product and application specifications.

No. of Pos.	Dimensions		C = .230 [5.84] D = .185 [4.70]		C = .320 [8.13] D = .200 [5.08]	
	A	B	Post Plating/Part Nos.		Post Plating/Part Nos.	
			Plating A	Plating B	Plating A	Plating B
3	.284 [7.21]	.200 [5.08]	146128-1	146132-1	146129-1	146133-1
4	.384 [9.75]	.300 [7.62]	146128-2	146132-2	146129-2	146133-2
5	.484 [12.29]	.400 [10.16]	146128-3	146132-3	146129-3	146133-3
6	.584 [14.83]	.500 [12.70]	146128-4	146132-4	146129-4	146133-4
7	.684 [17.37]	.600 [15.24]	146128-5	146132-5	146129-5	146133-5
8	.784 [19.91]	.700 [17.78]	146128-6	146132-6	146129-6	146133-6
9	.884 [22.45]	.800 [20.32]	146128-7	146132-7	146129-7	146133-7
10	.984 [24.99]	.900 [22.86]	146128-8	146132-8	146129-8	146133-8
11	1.084 [27.53]	1.000 [25.40]	146128-9	146132-9	146129-9	146133-9
12	1.184 [30.07]	1.100 [27.94]	1-146128-0	1-146132-0	1-146129-0	1-146133-0
13	1.284 [32.61]	1.200 [30.48]	1-146128-1	1-146132-1	1-146129-1	1-146133-1
14	1.384 [35.15]	1.300 [33.02]	1-146128-2	1-146132-2	1-146129-2	1-146133-2
15	1.484 [37.69]	1.400 [35.56]	1-146128-3	1-146132-3	1-146129-3	1-146133-3

**Breakaway Surface-Mount Headers—Unshrouded
Double-Row, .100 x .100 [2.54 x 2.54] Centerline**

**.025 [0.64] Square
Straight Post**

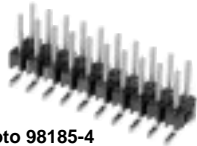

Photo 98185-4

Material and Finish:

Housing—Black thermoplastic, 94V-0 rated, high temperature compatible

Posts—Phosphor bronze, plated as follows:

Plating A—Duplex plated .000030 [0.00076] gold on contact area, .000100-.000200 [0.00254-0.00508] tin-lead on solder area, with entire post underplated .000050 [0.00127] nickel

Plating B— .000100-.000200 [0.00254-0.00508] tin-lead over .000050 [0.00127] nickel entire post

Related Product Data:

Mateable Receptacles—Refer to Mating Post Selection Guide (page 89)

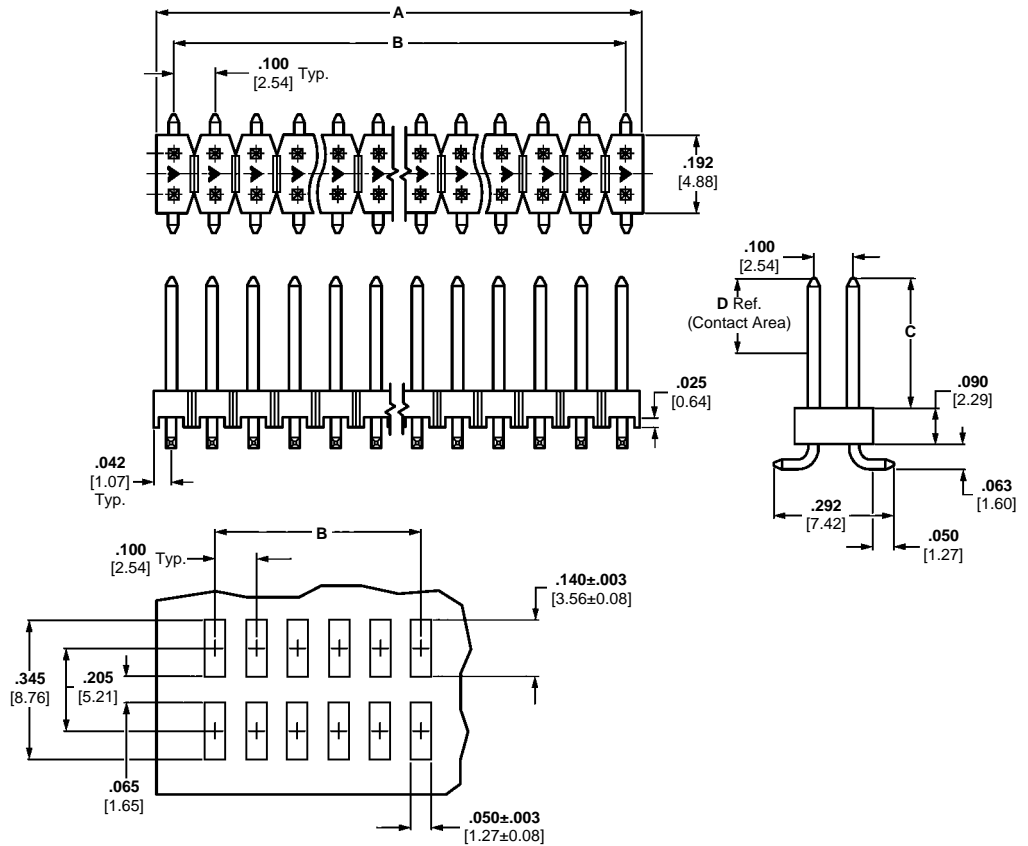

**Recommended Etched Circuit Layout
(Using .008 [0.20] thick stensil)**

No. of Pos.	Dimensions		C = .230 [5.84] D = .185 [4.70]		C = .320 [8.13] D = .200 [5.08]	
	A	B	Post Plating/Part Nos.		Post Plating/Part Nos.	
			Plating A	Plating B	Plating A	Plating B
4	.184 [4.67]	.100 [2.54]	146130-1	146134-1	146131-1	146135-1
6	.284 [7.21]	.200 [5.08]	146130-2	146134-2	146131-2	146135-2
8	.384 [9.75]	.300 [7.62]	146130-3	146134-3	146131-3	146135-3
10	.484 [12.29]	.400 [10.16]	146130-4	146134-4	146131-4	146135-4
12	.584 [14.83]	.500 [12.70]	146130-5	146134-5	146131-5	146135-5
14	.684 [17.37]	.600 [15.24]	146130-6	146134-6	146131-6	146135-6
16	.784 [19.91]	.700 [17.78]	146130-7	146134-7	146131-7	146135-7
18	.884 [22.45]	.800 [20.32]	146130-8	146134-8	146131-8	146135-8
20	.984 [24.99]	.900 [22.86]	146130-9	146134-9	146131-9	146135-9
22	1.084 [27.53]	1.000 [25.40]	1-146130-0	1-146134-0	1-146131-0	1-146135-0
24	1.184 [30.07]	1.100 [27.94]	1-146130-1	1-146134-1	1-146131-1	1-146135-1
26	1.284 [32.61]	1.200 [30.48]	1-146130-2	1-146134-2	1-146131-2	1-146135-2
28	1.384 [35.15]	1.300 [33.02]	1-146130-3	1-146134-3	1-146131-3	1-146135-3
30	1.484 [37.69]	1.400 [35.56]	1-146130-4	1-146134-4	1-146131-4	1-146135-4

Surface-Mount
Breakaway Headers

5

**Unshrouded Stacking Headers—Breakaway
.100 x .100 [2.54 x 2.54] Centerline****Product Facts**

- Available in single and double row
- Parallel PC board stacking with numerous stack heights available
- Drawn wire posts allow 4 side mateability
- May eliminate the need for additional board spacers
- Can be used in conjunction with bottom entry receptacles
- Gold or tin plated
- Up to 1.430 [36.32] overall post length
- Access sample request form Instruction Sheet Number 408-4236 on the Tyco Electronics FAX Information System
- Retention and surface mount features available upon request
- Other header sizes can be made upon request
- Tape and reel packaging available. Contact Tyco Electronics.
- Pick-and-place cap available for vacuum placement. Contact Tyco Electronics.

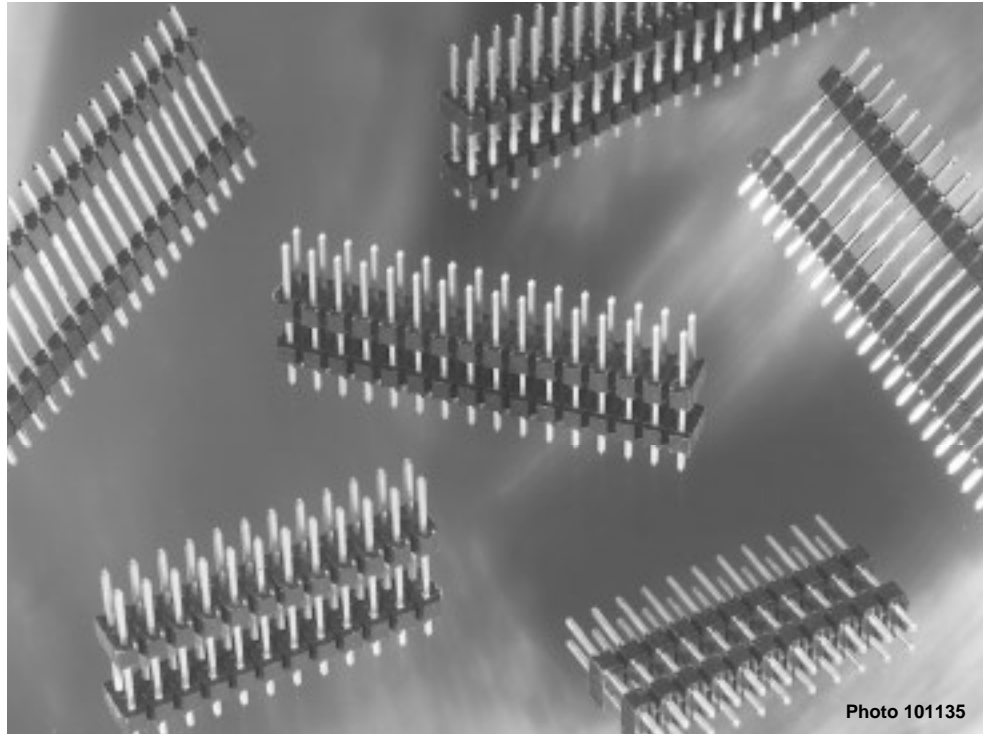

Photo 101135

**Breakaway Unshrouded Stacking Headers,
Single-Row, .100 [2.54] Centerline**

**.025 [0.64] Square
Straight Posts**

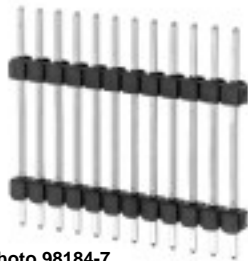

Photo 98184-7

Material and Finish:

Housing—Black thermoplastic, 94V-0 rated

Posts—Copper alloy, plated as follows:

Plating—As noted in chart

Tin—.000100-.000200 [0.03-.005] inch tin-lead over .000050 [0.012] inch nickel entire post

15Au—.000015 [0.003] inch gold over .000050 [0.012] inch nickel entire post

Related Product Data:

Mateable Receptacles—Refer to the Mating Post Selection Guide (page 89)

Technical Documents (page 294):

See mating connector for applicable product and application specifications.

Retention and surface mount features available upon request. Other header sizes can be made upon request.

***Note:** Headers are available in sizes 1 thru 40. When ordering, add the prefix and/or suffix (dash) numbers to the base part number that corresponds with the number of positions per row. For example, the complete part number for an 8-position header is 146455-8. The complete part number for a 16-position of the same series would be 1-146455-6.

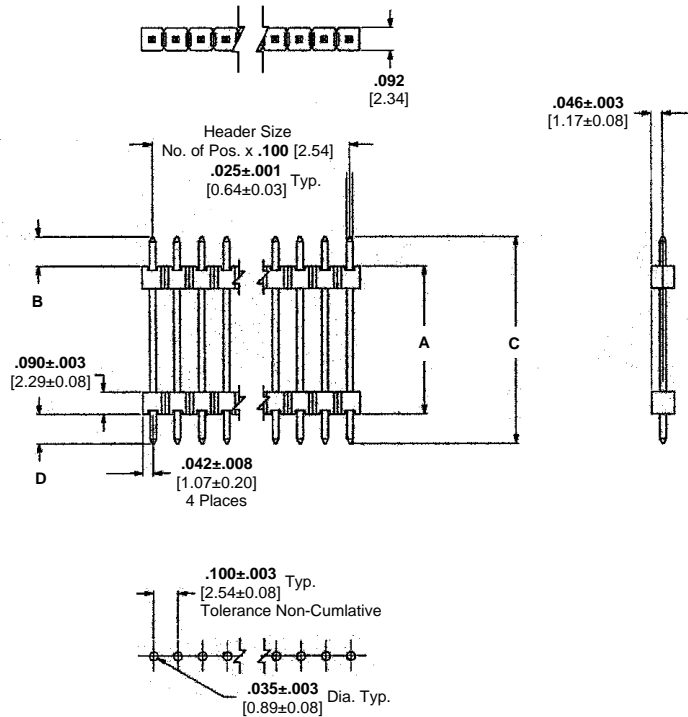

Recommended PC Board Hole Layout

Base Number (see note)	A Stack Height	B Tail Length	C Post Length	D Mating Length	B End Plating	D End Plating
146455	.200 [5.08]	.130 [3.30]	.440 [11.17]	.110 [2.79]	TIN	TIN
146456	.250 [6.35]	.080 [2.03]	.440 [11.17]	.110 [2.79]	TIN	TIN
146457	.250 [6.35]	.114 [2.89]	.474 [12.03]	.110 [2.79]	TIN	TIN
146758	.300 [7.62]	.123 [3.12]	.533 [13.53]	.110 [2.79]	TIN	TIN
146459	.400 [10.16]	.107 [2.71]	.617 [15.67]	.110 [2.79]	TIN	TIN
146460	.450 [11.43]	.057 [1.45]	.617 [15.67]	.110 [2.79]	TIN	TIN
146461	.500 [12.70]	.129 [3.27]	.739 [18.77]	.110 [2.79]	TIN	TIN
146462	.300 [7.62]	.109 [2.77]	.739 [18.77]	.330 [8.38]	TIN	15 AU
146463	.600 [15.24]	.107 [2.71]	.817 [20.75]	.110 [2.79]	TIN	TIN
146464	.400 [10.16]	.087 [2.20]	.817 [20.75]	.330 [8.38]	TIN	15 AU
146465	.700 [17.78]	.120 [3.05]	.930 [23.62]	.110 [2.79]	TIN	TIN
146466	.500 [12.70]	.100 [2.54]	.930 [23.62]	.330 [8.38]	TIN	15 AU
146467	.270 [6.86]	.330 [8.38]	.930 [23.62]	.330 [8.38]	15 AU	15 AU
146468	.800 [20.32]	.120 [3.05]	1.030 [26.16]	.110 [2.79]	TIN	TIN
146469	.600 [15.24]	.100 [2.54]	1.030 [26.16]	.330 [8.38]	TIN	15 AU
146470	.370 [9.39]	.330 [8.38]	1.030 [26.16]	.330 [8.38]	15 AU	15 AU
146471	.900 [22.86]	.120 [3.05]	1.130 [28.70]	.110 [2.79]	TIN	TIN
146472	.700 [17.78]	.100 [2.54]	1.130 [28.70]	.330 [8.38]	TIN	15 AU
146473	.470 [11.39]	.330 [8.38]	1.130 [28.70]	.330 [8.38]	15 AU	15 AU
146474	1.000 [25.40]	.120 [3.05]	1.230 [31.24]	.110 [2.79]	TIN	TIN
146475	.800 [20.32]	.100 [2.54]	1.230 [31.24]	.330 [8.38]	TIN	15 AU
146476	.570 [14.47]	.330 [8.38]	1.230 [31.24]	.330 [8.38]	15 AU	15 AU
146477	1.100 [27.94]	.120 [3.05]	1.330 [33.78]	.110 [2.79]	TIN	TIN
146478	.900 [22.68]	.100 [2.54]	1.330 [33.78]	.330 [8.38]	TIN	15 AU
146479	.670 [17.01]	.330 [8.38]	1.330 [33.78]	.330 [8.38]	15 AU	15 AU
146480	1.200 [30.48]	.120 [3.05]	1.430 [36.32]	.110 [2.79]	TIN	TIN
146481	1.000 [25.40]	.100 [2.54]	1.430 [36.32]	.330 [8.38]	TIN	15 AU
146482	.770 [19.55]	.330 [8.38]	1.430 [36.32]	.330 [8.38]	15 AU	15 AU

Unshrouded Stacking Headers-
Breakaway

5

**Breakaway Unshrouded Stacking Headers,
Double-Row, .100 x .100 [2.54 x 2.54] Centerline**

**.025 [0.64] Square
Straight Posts**



Photo 98184-6

Material and Finish:

Housing—Black thermoplastic, 94V-0 rated

Posts—Copper alloy, plated as follows:

Plating—As noted in chart

Tin—.000100-.000200 [.003-.005] inch tin-lead over .000050 [.0012] inch nickel entire post

15Au—.000015 [.0003] inch gold over .000050 [.0012] inch nickel entire post

Related Product Data:

Mateable Connectors—Refer to the Mating Post Selection Guide (page 89)

Technical Documents (page 294):

See mating connector for applicable product and application specifications.

Retention and surface mount features available upon request. Other header sizes can be made upon request.

***Note:** Headers are available in sizes 2 thru 80. When ordering, add the prefix and/or suffix (dash) numbers to the base part number that corresponds with the number of positions per row. For example, the complete part number for a 16-position header is 146283-8. The complete part number for a 32-position of the same series would be 1-146283-6.

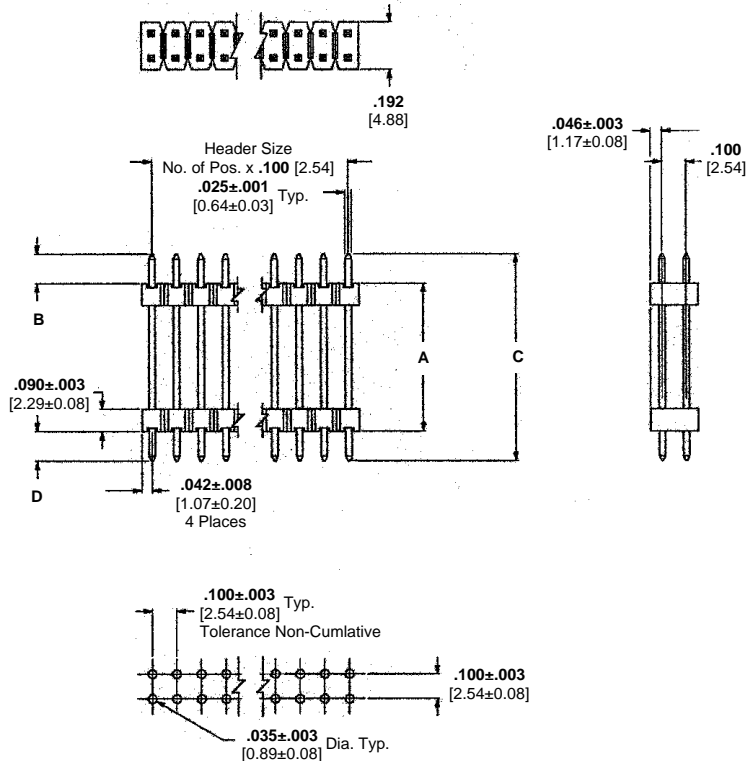

Recommended PC Board Hole Layout

Base Number (see note)	A Stack Height	B Tail Length	C Post Length	D Mating Length	B End Plating	D End Plating
146483	.200 [5.08]	.130 [3.30]	.440 [11.17]	.110 [2.79]	TIN	TIN
146484	.250 [6.35]	.080 [2.03]	.440 [11.17]	.110 [2.79]	TIN	TIN
146485	.250 [6.35]	.114 [2.89]	.474 [12.03]	.110 [2.79]	TIN	TIN
146486	.300 [7.62]	.123 [3.12]	.533 [13.53]	.110 [2.79]	TIN	TIN
146487	.400 [10.16]	.107 [2.71]	.617 [15.67]	.110 [2.79]	TIN	TIN
146488	.450 [11.43]	.057 [1.45]	.617 [15.67]	.110 [2.79]	TIN	TIN
146489	.500 [12.70]	.129 [3.27]	.739 [18.77]	.110 [2.79]	TIN	TIN
146490	.300 [7.62]	.109 [2.77]	.739 [18.77]	.330 [8.38]	TIN	15 AU
146491	.600 [15.24]	.107 [2.71]	.817 [20.75]	.110 [2.79]	TIN	TIN
146492	.400 [10.16]	.087 [2.20]	.817 [20.75]	.330 [8.38]	TIN	15 AU
146493	.700 [17.78]	.120 [3.05]	.930 [23.62]	.110 [2.79]	TIN	TIN
146494	.500 [12.70]	.100 [2.54]	.930 [23.62]	.330 [8.38]	TIN	15 AU
146495	.270 [6.86]	.330 [8.38]	.930 [23.62]	.330 [8.38]	15 AU	15 AU
146496	.800 [20.32]	.120 [3.05]	1.030 [26.16]	.110 [2.79]	TIN	TIN
146497	.600 [15.24]	.100 [2.54]	1.030 [26.16]	.330 [8.38]	TIN	15 AU
146498	.370 [9.39]	.330 [8.38]	1.030 [26.16]	.330 [8.38]	15 AU	15 AU
146499	.900 [22.86]	.120 [3.05]	1.130 [28.70]	.110 [2.79]	TIN	TIN
146500	.700 [17.78]	.100 [2.54]	1.130 [28.70]	.330 [8.38]	TIN	15 AU
146501	.470 [11.93]	.330 [8.38]	1.130 [28.70]	.330 [8.38]	15 AU	15 AU
146502	1.000 [25.40]	.120 [3.05]	1.230 [31.24]	.110 [2.79]	TIN	TIN
146503	.800 [20.32]	.100 [2.54]	1.230 [31.24]	.330 [8.38]	TIN	15 AU
146504	.570 [14.74]	.330 [8.38]	1.230 [31.24]	.330 [8.38]	15 AU	15 AU
146505	1.100 [27.94]	.120 [3.05]	1.330 [33.78]	.110 [2.79]	TIN	TIN
146506	.900 [22.68]	.100 [2.54]	1.330 [33.78]	.330 [8.38]	TIN	15 AU
146507	.670 [17.01]	.330 [8.38]	1.330 [33.78]	.330 [8.38]	15 AU	15 AU
146508	1.200 [30.48]	.120 [3.05]	1.430 [36.32]	.110 [2.79]	TIN	TIN
146509	1.000 [25.40]	.100 [2.54]	1.430 [36.32]	.330 [8.38]	TIN	15 AU
146510	.770 [19.55]	.330 [8.38]	1.430 [36.32]	.330 [8.38]	15 AU	15 AU

Standard Profile Headers—Shrouded

Product Facts

- Available in several styles—right-angle with three- and four-sided pin protection, and straight post with pin protection and mounting ears
- Post retention feature available
- Can be used for feed-to and feed-thru applications
- Housings are black thermoplastic, flame retardant 94V-0 rated
- Contacts are copper alloy
- Available in gold duplex, gold over nickel and tin-lead over nickel platings
- Headers with .066 [1.68] and .150 [3.81] end dimensions are available in select sizes up to 60 positions
- Can be select loaded, consult Tyco Electronics.
- Recognized under the Component Program of Underwriters Laboratories Inc. File No. E28476
- Certified by Canadian Standards Association, File No. LR 7189

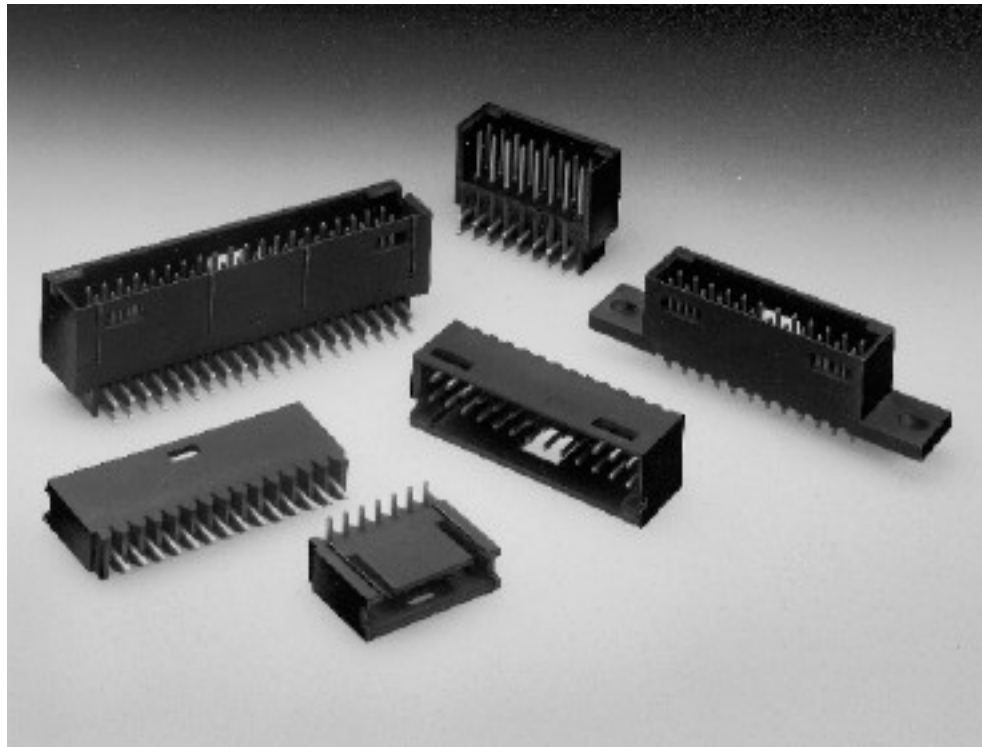

Performance Characteristics

Electrical:

Insulation Resistance—5,000 megohms minimum initial
Dielectric Withstanding Voltage—750 RMS at sea level

Environmental:

Operating Temperature—-65°C to +105°C (black thermoplastic housings)
Current—3 amperes maximum per contact

Standard Profile Headers,
Shrouded

5

Standard Profile Headers—Shrouded, Single-Row, .100 [2.54] Centerline

.025 [0.64] Square Straight Post (with Standoffs)

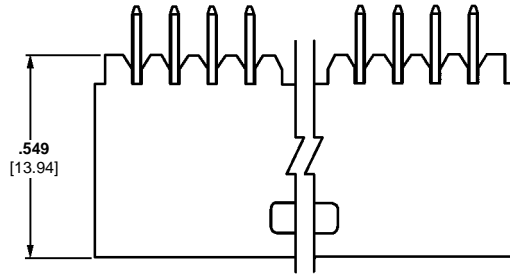

Material and Finish:

Housing—Black thermoplastic, 94V-0 rated

Posts—Copper alloy, plated as follows:

Plating A—Duplex plated .000030 [0.00076] gold on contact area, .000100-.000200 [0.00254-0.00508] tin-lead on solder area, with entire post underplated .000050 [0.00127] nickel

Plating B—Duplex plated .000015 [0.00038] gold on contact area, .000100-.000200 [0.00254-0.00508] tin-lead on solder area, with entire post underplated .000050 [0.00127] nickel

Plating C—.000100-.000200 [0.00254-0.00508] tin-lead over .000050 [0.00127] nickel on entire post

Related Product Data:

Mateable Connectors:
AMPMODU Wire-Applied Receptacles—page 232

AMPMODU MTE Receptacles—pages 245, 246, 251

Technical Documents (page 294):

See mating connector for applicable product and application specifications.

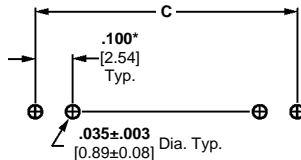
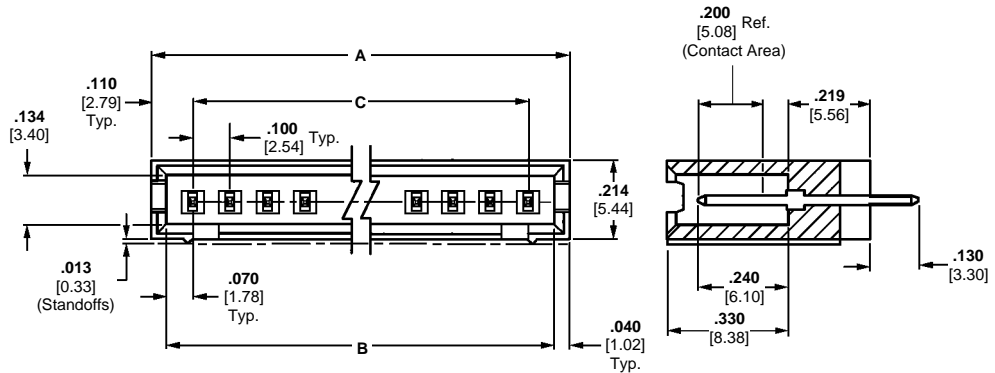

Recommended PC Board Hole Layout (for .055 [1.40] min. thick PC board)

*±.003 [±0.08] tolerances not to accumulate within one connector pattern.

No. of Pos.	Dimensions			Post Plating/Part Nos.		
	A	B	C	Plating A	Plating B	Plating C
3	.420 [10.67]	.340 [8.64]	.200 [5.08]	103414-1	3-102202-4	103080-1
4	.520 [13.21]	.440 [11.18]	.300 [7.62]	103414-2	102202-1	103080-2
5	.620 [15.75]	.540 [13.72]	.400 [10.16]	103414-3	102202-2	103080-3
6	.720 [18.29]	.640 [16.26]	.500 [12.70]	103414-4	102202-3	103080-4
7	.820 [20.83]	.740 [18.80]	.600 [15.24]	103414-5	102202-4	103080-5
8	.920 [23.37]	.840 [21.34]	.700 [17.78]	103414-6	102202-5	103080-6
9	1.020 [25.91]	.940 [23.88]	.800 [20.32]	103414-7	102202-6	103080-7
10	1.120 [28.45]	1.040 [26.42]	.900 [22.86]	103414-8	102202-7	103080-8

**Standard Profile Headers—Shrouded, Single-Row,
.100 [2.54] Centerline** (Continued)

No. of Pos.	Dimensions			Post Plating/Part Nos.		
	A	B	C	Plating A	Plating B	Plating C
11	1.220 [30.99]	1.140 [28.96]	1.000 [25.40]	103414-9	102202-8	103080-9
12	1.320 [33.53]	1.240 [31.50]	1.100 [27.94]	1-103414-0	102202-9	1-103080-0
13	1.420 [36.07]	1.340 [34.04]	1.200 [30.48]	1-103414-1	1-102202-0	1-103080-1
14	1.520 [38.61]	1.440 [36.58]	1.300 [33.02]	1-103414-2	1-102202-1	1-103080-2
15	1.620 [41.15]	1.540 [39.12]	1.400 [35.56]	1-103414-3	1-102202-2	1-103080-3
16	1.720 [43.69]	1.640 [41.66]	1.500 [38.10]	1-103414-4	1-102202-3	1-103080-4
17	1.820 [46.23]	1.740 [44.20]	1.600 [40.64]	1-103414-5	1-102202-4	1-103080-5
18	1.920 [48.77]	1.840 [46.74]	1.700 [43.18]	1-103414-6	1-102202-5	1-103080-6
19	2.020 [51.31]	1.940 [49.28]	1.800 [45.72]	1-103414-7	1-102202-6	1-103080-7
20	2.120 [53.85]	2.040 [51.82]	1.900 [48.26]	1-103414-8	1-102202-7	1-103080-8
21	2.220 [56.39]	2.140 [54.36]	2.000 [50.80]	1-103414-9	1-102202-8	1-103080-9
22	2.320 [58.93]	2.240 [56.90]	2.100 [53.34]	2-103414-0	1-102202-9	2-103080-0
23	2.420 [61.47]	2.340 [59.44]	2.200 [55.88]	2-103414-1	2-102202-0	2-103080-1
24	2.520 [64.01]	2.440 [61.98]	2.300 [58.42]	2-103414-2	2-102202-1	2-103080-2
25	2.620 [66.55]	2.540 [64.52]	2.400 [60.96]	2-103414-3	2-102202-2	2-103080-3

**Standard Profile Headers—Shrouded,
Single-Row, .100 [2.54] Centers** (Continued)

**.025 [0.64] Square
Right-Angle Post
(with Standoffs)**

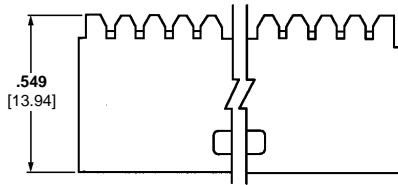

Material and Finish:

Housing—Black thermoplastic, 94V-0 rated

Posts—Copper alloy, plated as follows:

Plating A—Duplex plated .000030 [0.00076] gold on contact area, .000100-.000200 [0.00254-0.00508] tin-lead on solder area, with entire post underplated .000050 [0.00127] nickel

Plating B—Duplex plated .000015 [0.00038] gold on contact area, .000100-.000200 [0.00254-0.00508] tin-lead on solder area, with entire post underplated .000050 [0.00127] nickel

Plating C— .000100-.000200 [0.00254-0.00508] tin-lead over .000050 [0.00127] nickel on entire post

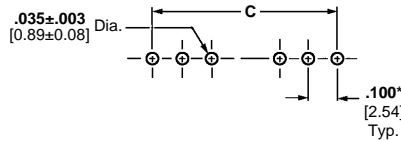
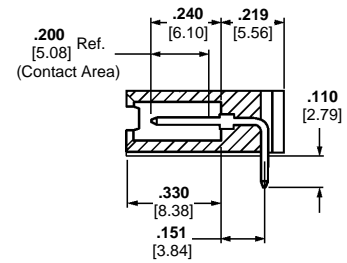
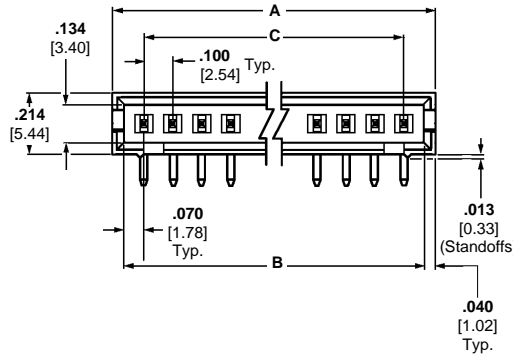

**Recommended PC Board Hole Layout
(for .055 [1.40] min. thick PC board)**

*±.003 [±0.08] tolerances not to accumulate within one connector pattern.

Related Product Data:

Mateable Connectors:

AMPMODU Wire-Applied

Receptacles—page 232

AMPMODU MTE Receptacles—
pages 245, 246, 251

Technical Documents (page 294):

See mating connector for applicable product and application specifications.

No. of Pos.	Dimensions			Post Plating/Part Nos.		
	A	B	C	Plating A	Plating B	Plating C
3	.420 [10.67]	.340 [8.64]	.200 [5.08]	103361-1	3-102203-4	102523-1
4	.520 [13.21]	.440 [11.18]	.300 [7.62]	103361-2	102203-1	102523-2
5	.620 [15.75]	.540 [13.72]	.400 [10.16]	103361-3	102203-2	102523-3
6	.720 [18.29]	.640 [16.26]	.500 [12.70]	103361-4	102203-3	102523-4
7	.820 [20.83]	.740 [18.80]	.600 [15.24]	103361-5	102203-4	102523-5
8	.920 [23.37]	.840 [21.34]	.700 [17.78]	103361-6	102203-5	102523-6
9	1.020 [25.91]	.940 [23.88]	.800 [20.32]	103361-7	102203-6	102523-7
10	1.120 [28.45]	1.040 [26.42]	.900 [22.86]	103361-8	102203-7	102523-8

**Standard Profile Headers—Shrouded,
Single-Row, .100 [2.54] Centers** (Continued)

No. of Pos.	Dimensions			Post Plating/Part Nos.		
	A	B	C	Plating A	Plating B	Plating C
11	1.220 [30.99]	1.140 [28.96]	1.000 [25.40]	103361-9	102203-8	102523-9
12	1.320 [33.53]	1.240 [31.50]	1.100 [27.94]	1-103361-0	102203-9	1-102523-0
13	1.420 [36.07]	1.340 [34.04]	1.200 [30.48]	1-103361-1	1-102203-0	1-102523-1
14	1.520 [38.61]	1.440 [36.58]	1.300 [33.02]	1-103361-2	1-102203-1	1-102523-2
15	1.620 [41.15]	1.540 [39.12]	1.400 [35.56]	1-103361-3	1-102203-2	1-102523-3
16	1.720 [43.69]	1.640 [41.66]	1.500 [38.10]	1-103361-4	1-102203-3	1-102523-4
17	1.820 [46.23]	1.740 [44.20]	1.600 [40.64]	1-103361-5	1-102203-4	1-102523-5
18	1.920 [48.77]	1.840 [46.74]	1.700 [43.18]	1-103361-6	1-102203-5	1-102523-6
19	2.020 [51.31]	1.940 [49.28]	1.800 [45.72]	1-103361-7	1-102203-6	1-102523-7
20	2.120 [53.85]	2.040 [51.82]	1.900 [48.26]	1-103361-8	1-102203-7	1-102523-8
21	2.220 [56.39]	2.140 [54.36]	2.000 [50.80]	1-103361-9	1-102203-8	1-102523-9
22	2.320 [58.93]	2.240 [56.90]	2.100 [53.34]	2-103361-0	1-102203-9	2-102523-0
23	2.420 [61.47]	2.340 [59.44]	2.200 [55.88]	2-103361-1	2-102203-0	2-102523-1
24	2.520 [64.01]	2.440 [61.98]	2.300 [58.42]	2-103361-2	2-102203-1	2-102523-2
25	2.620 [66.55]	2.540 [64.52]	2.400 [60.96]	2-103361-3	2-102203-2	2-102523-3

Standard Profile Headers—Shrouded, with .066 [1.68] End Dimension, Double-Row, .100 x .100 [2.54 x 2.54] Centerline

.025 [0.64] Square Straight Post (with Detent Windows)



Material and Finish:

- Housing**—Black thermoplastic, 94V-0 rated
- Posts**—Copper alloy, plated as follows:
- Plating A**—Duplex plated .000030 [0.00076] gold on contact area, .000100-.000200 [0.00254-0.00508] tin-lead on solder area, with entire post underplated .000050 [0.00127] nickel
- Plating B**—Duplex plated .000015 [0.00038] gold on contact area, .000100-.000200 [0.00254-0.00508] tin-lead on solder area, with entire post underplated .000050 [0.00127] nickel
- Plating C**—.000100-.000200 [0.00254-0.00508] tin-lead over .000050 [0.00127] nickel on entire post

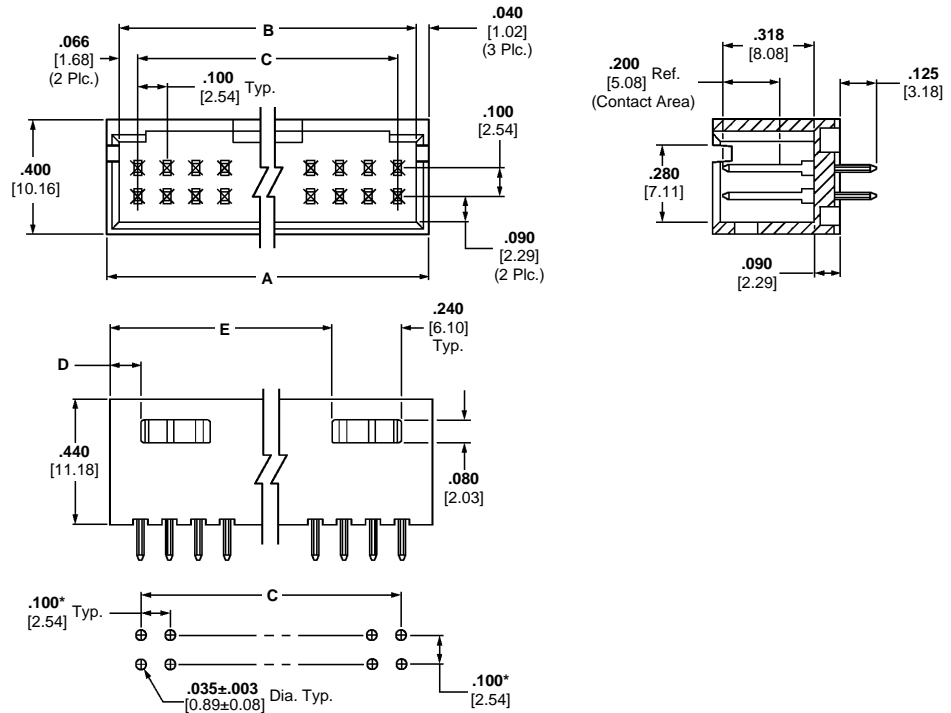

Recommended PC Board Hole Layout (for .055 [1.40] min. thick PC board)

*±.003 [±0.08] tolerances not to accumulate within one connector pattern.

Related Product Data:

- Mateable Connectors:**
- AMPMODU Board Mount Receptacles**—pages 193, 196, 197
- AMPMODU Wire-Applied Receptacles**—pages 233-236
- AMPMODU MTE Receptacles**—pages 245, 246, 251
- AMPMODU MT Receptacles**—pages 275, 276

Accessories:

Barrier Insert—page 221

Technical Documents (page 294):

See mating connector for applicable product and application specifications.

No. of Pos.	Dimensions					Post Plating/Part Nos.		
	A	B	C	D	E	Plating A	Plating B	Plating C
6	.412 [10.46]	.332 [8.43]	.200 [5.08]	.106 [2.69]	—	103168-1	102618-1	3-87589-6
8	.512 [13.00]	.432 [10.97]	.300 [7.62]	.106 [2.69]	—	103168-2	102618-2	3-87589-5
10	.612 [15.54]	.532 [13.51]	.400 [10.16]	.206 [5.23]	—	103168-3	102618-3	87589-1
12	.712 [18.08]	.632 [16.05]	.500 [12.70]	.206 [5.23]	—	103168-4	102618-4	87589-2
14	.812 [20.62]	.732 [18.59]	.600 [15.24]	.306 [7.77]	—	103168-5	102618-5	87589-3
16	.912 [23.16]	.832 [21.13]	.700 [17.78]	.306 [7.77]	—	103168-6	102618-6	87589-4
18	1.012 [25.70]	.932 [23.67]	.800 [20.32]	.406 [10.31]	—	103168-7	102618-7	87589-5
20	1.112 [28.24]	1.032 [26.21]	.900 [22.86]	.106 [2.69]	.806 [20.47]	103168-8	102618-8	87589-6
22	1.212 [30.78]	1.132 [28.75]	1.000 [25.40]	.106 [2.69]	.906 [23.01]	103168-9	102618-9	87589-7
24	1.312 [33.32]	1.232 [31.29]	1.100 [27.94]	.106 [2.69]	1.006 [25.55]	1-103168-0	1-102618-0	87589-8
26	1.412 [35.86]	1.332 [33.83]	1.200 [30.48]	.106 [2.69]	1.106 [28.09]	1-103168-1	1-102618-1	87589-9
28	1.512 [38.40]	1.432 [36.37]	1.300 [33.02]	.106 [2.69]	1.206 [30.63]	1-103168-2	1-102618-2	1-87589-0
30	1.612 [40.94]	1.532 [38.91]	1.400 [35.56]	.106 [2.69]	1.306 [33.17]	1-103168-3	1-102618-3	1-87589-1

Standard Profile Headers, Shrouded

5

Standard Profile Headers—Shrouded, with .066 [1.68] End Dimension, Double-Row, .100 x .100 [2.54 x 2.54] Centerline (Continued)

No. of Positions	Dimensions					Post Plating/Part Nos.		
	A	B	C	D	E	Plating A	Plating B	Plating C
32	1.712 [43.48]	1.632 [41.45]	1.500 [38.10]	.106 [2.69]	1.406 [35.71]	1-103168-4	1-102618-4	1-87589-2
34	1.812 [46.02]	1.732 [43.99]	1.600 [40.64]	.106 [2.69]	1.506 [38.25]	1-103168-5	1-102618-5	1-87589-3
36	1.912 [48.56]	1.832 [46.53]	1.700 [43.18]	.106 [2.69]	1.606 [40.79]	1-103168-6	1-102618-6	1-87589-4
38	2.012 [51.10]	1.932 [49.07]	1.800 [45.72]	.106 [2.69]	1.706 [43.33]	1-103168-7	1-102618-7	1-87589-5
40	2.112 [53.64]	2.032 [51.61]	1.900 [48.26]	.106 [2.69]	1.806 [45.87]	1-103168-8	1-102618-8	1-87589-6
42	2.212 [56.18]	2.132 [54.15]	2.000 [50.80]	.106 [2.69]	1.906 [48.41]	1-103168-9	1-102618-9	1-87589-7
44	2.312 [58.72]	2.232 [56.69]	2.100 [53.34]	.106 [2.69]	2.006 [50.95]	2-103168-0	2-102618-0	1-87589-8
46	2.412 [61.26]	2.332 [59.23]	2.200 [55.88]	.106 [2.69]	2.106 [53.49]	2-103168-1	2-102618-1	1-87589-9
48	2.512 [63.80]	2.432 [61.77]	2.300 [58.42]	.106 [2.69]	2.206 [56.03]	2-103168-2	2-102618-2	2-87589-0
50	2.612 [66.34]	2.532 [64.31]	2.400 [60.96]	.106 [2.69]	2.306 [58.57]	2-103168-3	2-102618-3	2-87589-1
52	2.712 [68.88]	2.632 [66.85]	2.500 [63.50]	.106 [2.69]	2.406 [61.11]	2-103168-4	2-102618-4	2-87589-2
54	2.812 [71.42]	2.732 [69.39]	2.600 [66.04]	.106 [2.69]	2.506 [63.65]	2-103168-5	2-102618-5	2-87589-3
56	2.912 [73.96]	2.832 [71.93]	2.700 [68.58]	.106 [2.69]	2.606 [66.19]	2-103168-6	2-102618-6	2-87589-4
58	3.012 [76.50]	2.932 [74.47]	2.800 [71.12]	.106 [2.69]	2.706 [68.73]	2-103168-7	2-102618-7	2-87589-5
60	3.112 [79.04]	3.032 [77.01]	2.900 [73.66]	.106 [2.69]	2.806 [71.27]	2-103168-8	2-102618-8	2-87589-6
62	3.212 [81.58]	3.132 [79.55]	3.000 [76.20]	.106 [2.69]	2.906 [73.81]	2-103168-9	2-102618-9	2-87589-7
64	3.312 [84.12]	3.232 [82.09]	3.100 [78.74]	.106 [2.69]	3.006 [76.35]	3-103168-0	3-102618-0	2-87589-8
66	3.412 [86.66]	3.332 [84.63]	3.200 [81.28]	.106 [2.69]	3.106 [78.89]	3-103168-1	3-102618-1	2-87589-9
68	3.512 [89.20]	3.432 [87.17]	3.300 [83.82]	.106 [2.69]	3.206 [81.43]	3-103168-2	3-102618-2	3-87589-0
70	3.612 [91.74]	3.532 [89.71]	3.400 [86.36]	.106 [2.69]	3.306 [83.97]	3-103168-3	3-102618-3	3-87589-1
72	3.712 [94.28]	3.632 [92.25]	3.500 [88.90]	.106 [2.69]	3.406 [86.51]	3-103168-4	3-102618-4	3-87589-2
74	3.812 [96.82]	3.732 [94.79]	3.600 [91.44]	.106 [2.69]	3.506 [89.05]	3-103168-5	3-102618-5	3-87589-3

Standard Profile Headers—Shrouded, with .150 [3.81] End Dimension, Double-Row, .100 x .100 [2.54 x 2.54] Centerline

.025 [0.64] Square Straight Post (with Detent Windows)

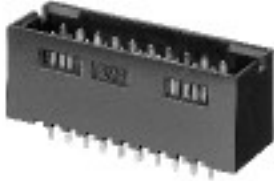

Material and Finish:

Housing—Black thermoplastic, 94V-0 rated

Posts—Copper alloy, plated as follows:

Plating A—Duplex plated .000030 [0.00076] gold on contact area, .000100-.000200 [0.00254-0.00508] tin-lead on solder area, with entire post underplated .000050 [0.00127] nickel

Plating B—Duplex plated .000015 [0.00038] gold on contact area, .000100-.000200 [0.00254-0.00508] tin-lead on solder area, with entire post underplated .000050 [0.00127] nickel

Plating C—.000100-.000200 [0.00254-0.00508] tin-lead over .000050 [0.00127] nickel on entire post

Related Product Data:

Mateable Connectors:

AMP/AMPMODU MTE Receptacles—pages 249, 250, 252 (used with coupling shroud on page 258)

AMP/AMPMODU Wire-Applied Receptacles—pages 233-236

Accessories:

Barrier Insert—page 221

Technical Documents (page 294):

See mating connector for applicable product and application specifications.

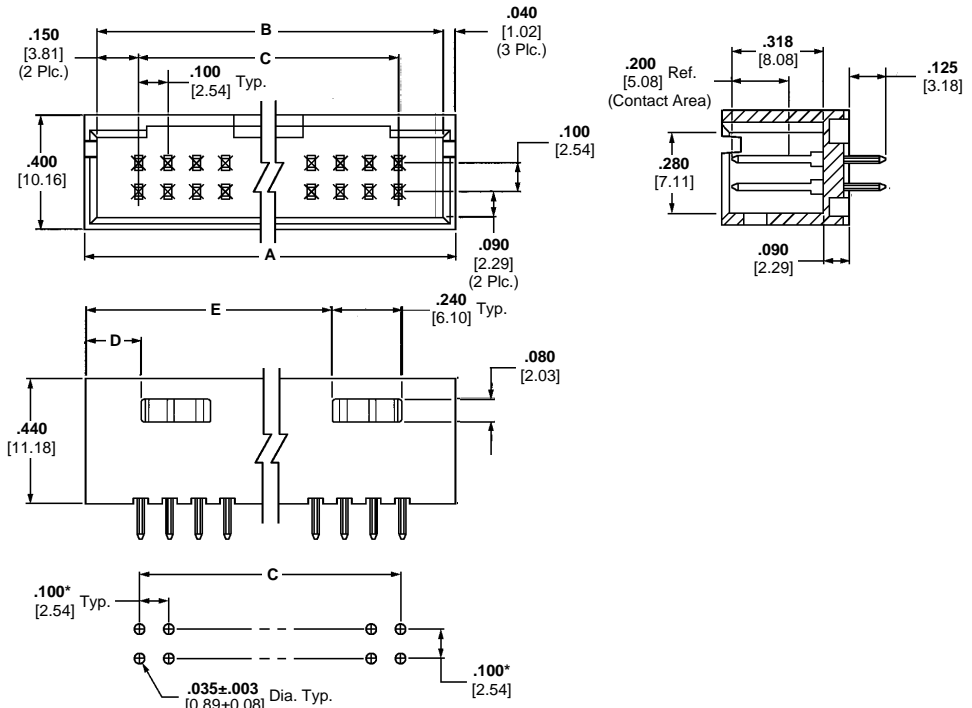

Recommended PC Board Hole Layout (for .055 [1.40] min. thick PC board)

*±.003 [±0.08] tolerances not to accumulate within one connector pattern.

No. of Pos.	Dimensions					Post Plating/Part Nos.		
	A	B	C	D	E	Plating A	Plating B	Plating C
6	.580 [14.73]	.500 [12.70]	.200 [5.08]	.190 [4.83]	—	103169-1	102619-1	3-87587-4
8	.680 [17.27]	.600 [15.24]	.300 [7.62]	.190 [4.83]	—	103169-2	102619-2	3-87587-3
10	.780 [19.81]	.700 [17.78]	.400 [10.16]	.290 [7.37]	—	103169-3	102619-3	87587-1
12	.880 [22.35]	.800 [20.32]	.500 [12.70]	.290 [7.37]	—	103169-4	102619-4	87587-2
14	.980 [24.89]	.900 [22.86]	.600 [15.24]	.390 [9.91]	—	103169-5	102619-5	87587-3
16	1.080 [27.43]	1.000 [25.40]	.700 [17.78]	.390 [9.91]	—	103169-6	102619-6	87587-4
18	1.180 [29.97]	1.100 [27.94]	.800 [20.32]	.490 [12.45]	—	103169-7	102619-7	87587-5
20	1.280 [32.51]	1.200 [30.48]	.900 [22.86]	.190 [4.83]	.890 [22.61]	103169-8	102619-8	87587-6
22	1.380 [35.05]	1.300 [33.02]	1.000 [25.40]	.190 [4.83]	.990 [25.15]	103169-9	102619-9	87587-7
24	1.480 [37.59]	1.400 [35.56]	1.100 [27.94]	.190 [4.83]	1.090 [27.69]	1-103169-0	1-102619-0	87587-8
26	1.580 [40.13]	1.500 [38.10]	1.200 [30.48]	.190 [4.83]	1.190 [30.23]	1-103169-1	1-102619-1	87587-9
28	1.680 [42.67]	1.600 [40.64]	1.300 [33.02]	.190 [4.83]	1.290 [32.77]	1-103169-2	1-102619-2	1-87587-0
30	1.780 [45.21]	1.700 [43.18]	1.400 [35.56]	.190 [4.83]	1.390 [35.31]	1-103169-3	1-102619-3	1-87587-1

Standard Profile Headers—Shrouded, with .150 [3.81] End Dimension, Double-Row, .100 x .100 [2.54 x 2.54] Centerline (Continued)

No. of Pos.	Dimensions					Post Plating/Part Nos.		
	A	B	C	D	E	Plating A	Plating B	Plating C
32	1.880 [47.75]	1.800 [45.72]	1.500 [38.10]	.190 [4.83]	1.490 [37.85]	1-103169-4	1-102619-4	1-87587-2
34	1.980 [50.29]	1.900 [48.26]	1.600 [40.64]	.190 [4.83]	1.590 [40.39]	1-103169-5	1-102619-5	1-87587-3
36	2.080 [52.83]	2.000 [50.80]	1.700 [43.18]	.190 [4.83]	1.690 [42.93]	1-103169-6	1-102619-6	1-87587-4
38	2.180 [55.37]	2.100 [53.34]	1.800 [45.72]	.190 [4.83]	1.790 [45.47]	1-103169-7	1-102619-7	1-87587-5
40	2.280 [57.91]	2.200 [55.88]	1.900 [48.26]	.190 [4.83]	1.890 [48.01]	1-103169-8	1-102619-8	1-87587-6
42	2.380 [60.45]	2.300 [58.42]	2.000 [50.80]	.190 [4.83]	1.990 [50.55]	1-103169-9	1-102619-9	1-87587-7
44	2.480 [62.99]	2.400 [60.96]	2.100 [53.34]	.190 [4.83]	2.090 [53.09]	2-103169-0	2-102619-0	1-87587-8
46	2.580 [65.53]	2.500 [63.50]	2.200 [55.88]	.190 [4.83]	2.190 [55.63]	2-103169-1	2-102619-1	1-87587-9
48	2.680 [68.07]	2.600 [66.04]	2.300 [58.42]	.190 [4.83]	2.290 [58.17]	2-103169-2	2-102619-2	2-87587-0
50	2.780 [70.61]	2.700 [68.58]	2.400 [60.96]	.190 [4.83]	2.390 [60.71]	2-103169-3	2-102619-3	2-87587-1
52	2.880 [73.15]	2.800 [71.12]	2.500 [63.50]	.190 [4.83]	2.490 [63.25]	2-103169-4	2-102619-4	2-87587-2
54	2.980 [75.69]	2.900 [73.66]	2.600 [66.04]	.190 [4.83]	2.590 [65.79]	2-103169-5	2-102619-5	2-87587-3
56	3.080 [78.23]	3.000 [76.20]	2.700 [68.58]	.190 [4.83]	2.690 [68.33]	2-103169-6	2-102619-6	2-87587-4
58	3.180 [80.77]	3.100 [78.74]	2.800 [71.12]	.190 [4.83]	2.790 [70.87]	2-103169-7	2-102619-7	2-87587-5
60	3.280 [83.31]	3.200 [81.28]	2.900 [73.66]	.190 [4.83]	2.890 [73.41]	2-103169-8	2-102619-8	2-87587-6
62	3.380 [85.85]	3.300 [83.82]	3.000 [76.20]	.190 [4.83]	2.990 [75.95]	2-103169-9	2-102619-9	2-87587-7
64	3.480 [88.39]	3.400 [86.36]	3.100 [78.74]	.190 [4.83]	3.090 [78.49]	3-103169-0	3-102619-0	2-87587-8
66	3.580 [90.93]	3.500 [88.90]	3.200 [81.28]	.190 [4.83]	3.190 [81.03]	3-103169-1	3-102619-1	2-87587-9
68	3.680 [93.47]	3.600 [91.44]	3.300 [83.82]	.190 [4.83]	3.290 [83.57]	3-103169-2	3-102619-2	3-87587-0
70	3.780 [96.01]	3.700 [93.98]	3.400 [86.36]	.190 [4.83]	3.390 [86.11]	3-103169-3	3-102619-3	3-87587-1
72	3.880 [98.55]	3.800 [96.52]	3.500 [88.90]	.190 [4.83]	3.490 [88.65]	3-103169-4	3-102619-4	3-87587-2

Standard Profile Headers—Shrouded, with .150 [3.81] End Dimension, Double-Row, .100 x .100 [2.54 x 2.54] Centerline (Continued)

.025 [0.64] Square Straight Post (with Plastic Holddowns)



Photo 98185-8

Material and Finish:

Housing—Black thermoplastic, 94V-0 rated

Posts—Copper alloy, duplex plated .000015 [0.00038] gold on contact area, .000100-.000200 [0.00254-0.00508] tin-lead on solder area, with entire post underplated .000050 [0.00127] nickel

Related Product Data:

Mateable Connectors:

AMPMODU MTE Receptacles—pages 249, 250, 252 (used with coupling shroud on page 258)

AMPMODU Wire-Applied Receptacles—pages 233-236

Accessories:

Barrier Insert—page 221

Technical Documents (page 294):

See mating connector for applicable product and application specifications.

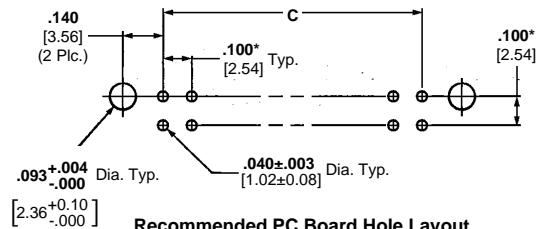
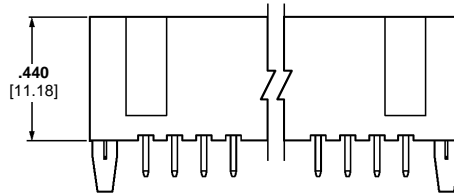
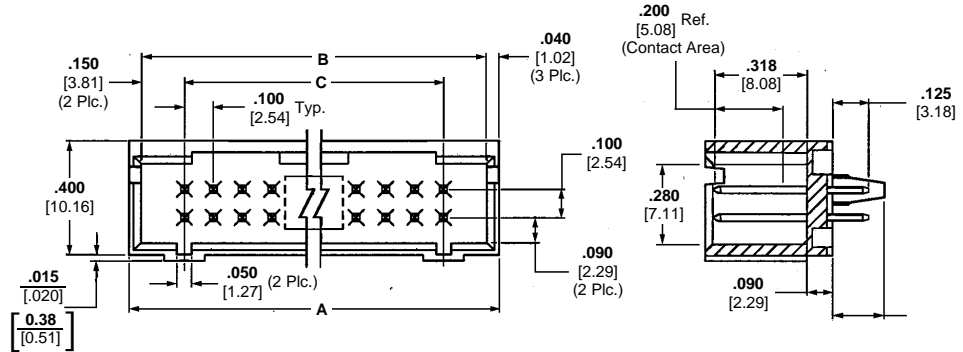

Recommended PC Board Hole Layout (for .055 [1.40] min. thick PC board)

*±.003 [±0.08] tolerances not to accumulate within one connector pattern.

No. of Pos.	Dimensions			Part Nos. Plating A
	A	B	C	
6	.580 [14.73]	.500 [12.70]	.200 [5.08]	104317-1
10	.780 [19.81]	.700 [17.78]	.400 [10.16]	104317-2
12	.880 [22.35]	.800 [20.32]	.500 [12.70]	104317-3
14	.980 [24.89]	.900 [22.86]	.600 [15.24]	104317-4
16	1.080 [27.43]	1.000 [25.40]	.700 [17.78]	1-104317-6
18	1.180 [29.97]	1.100 [27.94]	.800 [20.32]	104317-5

**Standard Profile Headers—Shrouded, with .150 [3.81] End Dimension,
Double-Row, .100 x .100 [2.54 x 2.54] Centerline (Continued)**

No. of Pos.	Dimensions			Part Nos. Plating A
	A	B	C	
20	1.280 [32.51]	1.200 [30.48]	.900 [22.86]	104317-6
22	1.380 [35.05]	1.300 [33.02]	1.000 [25.40]	104317-7
24	1.480 [37.59]	1.400 [35.56]	1.100 [27.94]	104317-8
26	1.580 [40.13]	1.500 [38.10]	1.200 [30.48]	104317-9
30	1.780 [45.21]	1.700 [43.18]	1.400 [35.56]	1-104317-0
32	1.880 [47.75]	1.800 [45.72]	1.500 [38.10]	1-104317-1
34	1.980 [50.29]	1.900 [48.26]	1.600 [40.64]	1-104317-8
36	2.080 [52.83]	2.000 [50.80]	1.700 [43.18]	1-104317-7
40	2.280 [57.91]	2.200 [55.88]	1.900 [48.26]	1-104317-2
42	2.380 [60.45]	2.300 [58.42]	2.000 [50.80]	1-104317-5
48	2.680 [68.07]	2.600 [66.04]	2.300 [58.42]	1-104317-3
50	2.780 [70.61]	2.700 [68.58]	2.400 [60.96]	1-104317-4

Standard Profile Headers—Shrouded, with .066 [1.68] End Dimension, Double-Row, .100 x .100 [2.54 x 2.54] Centerline

.025 [0.64] Square Right-Angle Post (with Detent Windows)

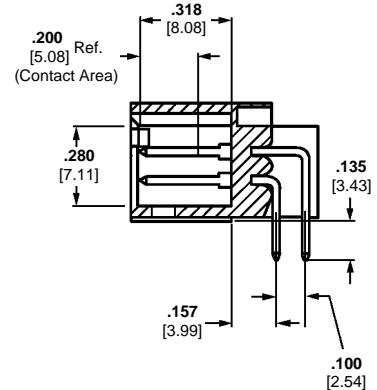
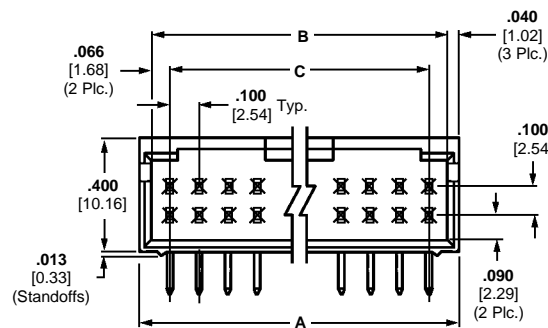

Material and Finish:

Housing—Black thermoplastic, 94V-0 rated

Posts—Copper alloy, plated as follows:

Plating A—Duplex plated .000030 [0.00076] gold on contact area, .000100-.000200 [0.00254-0.00508] tin-lead on solder area, with entire post underplated .000050 [0.00127] nickel

Plating B—Duplex plated .000015 [0.00038] gold on contact area, .000100-.000200 [0.00254-0.00508] tin-lead on solder area, with entire post underplated .000050 [0.00127] nickel

Plating C—.000100-.000200 [0.00254-0.00508] tin-lead over .000050 [0.00127] nickel on entire post

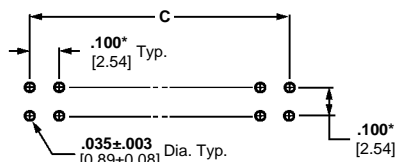
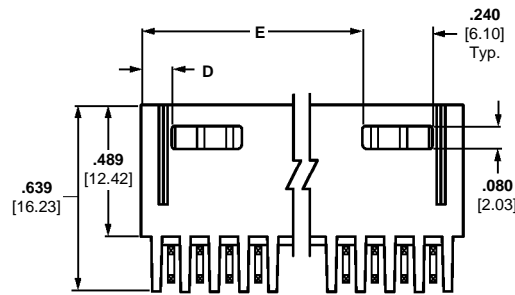

Recommended PC Board Hole Layout (for .055 [1.40] min. thick PC board)

*±.003 [±0.08] tolerances not to accumulate within one connector pattern.

Related Product Data:

Mateable Connectors:

AMPMODU Board Mount

Receptacles—pages 193, 196, 197

AMPMODU Wire-Applied

Receptacles—pages 233-236

AMPMODU MTE Receptacles—

pages 245, 246, 251

AMPMODU MT Receptacles—

pages 275, 276

Technical Documents (page 294):

See mating connector for applicable product and application specifications.

No. of Pos.	Dimensions					Post Plating/Part Nos.		
	A	B	C	D	E	Plating A	Plating B	Plating C
6	.412 [10.46]	.332 [8.43]	.200 [5.08]	.106 [2.69]	—	103166-1	102617-1	3-87579-5
8	.512 [13.00]	.432 [10.97]	.300 [7.62]	.106 [2.69]	—	103166-2	102617-2	87579-1
10	.612 [15.54]	.532 [13.51]	.400 [10.16]	.206 [5.23]	—	103166-3	102617-3	87579-2
12	.712 [18.08]	.632 [16.05]	.500 [12.70]	.206 [5.23]	—	103166-4	102617-4	87579-3
14	.812 [20.62]	.732 [18.59]	.600 [15.24]	.306 [7.77]	—	103166-5	102617-5	87579-4
16	.912 [23.16]	.832 [21.13]	.700 [17.78]	.306 [7.77]	—	103166-6	102617-6	87579-5
18	1.012 [25.70]	.932 [23.67]	.800 [20.32]	.406 [10.31]	—	103166-7	102617-7	87579-6
20	1.112 [28.24]	1.032 [26.21]	.900 [22.86]	.106 [2.69]	.806 [20.47]	103166-8	102617-8	87579-7
22	1.212 [30.78]	1.132 [28.75]	1.000 [25.40]	.106 [2.69]	.906 [23.01]	103166-9	102617-9	87579-8
24	1.312 [33.32]	1.232 [31.29]	1.100 [27.94]	.106 [2.69]	1.006 [25.55]	1-103166-0	1-102617-0	87579-9
26	1.412 [35.86]	1.332 [33.83]	1.200 [30.48]	.106 [2.69]	1.106 [28.09]	1-103166-1	1-102617-1	1-87579-0
28	1.512 [38.40]	1.432 [36.37]	1.300 [33.02]	.106 [2.69]	1.206 [30.63]	1-103166-2	1-102617-2	1-87579-1
30	1.612 [40.94]	1.532 [38.91]	1.400 [35.56]	.106 [2.69]	1.306 [33.17]	1-103166-3	1-102617-3	1-87579-2

Standard Profile Headers—Shrouded, with .066 [1.68] End Dimension, Double-Row, .100 x .100 [2.54 x 2.54] Centerline (Continued)

No. of Pos.	Dimensions					Post Plating/Part Nos.		
	A	B	C	D	E	Plating A	Plating B	Plating C
32	1.712 [43.48]	1.632 [41.45]	1.500 [38.10]	.106 [2.69]	1.406 [35.71]	1-103166-4	1-102617-4	1-87579-3
34	1.812 [46.02]	1.732 [43.99]	1.600 [40.64]	.106 [2.69]	1.506 [38.25]	1-103166-5	1-102617-5	1-87579-4
36	1.912 [48.56]	1.832 [46.53]	1.700 [43.18]	.106 [2.69]	1.606 [40.79]	1-103166-6	1-102617-6	1-87579-5
38	2.012 [51.10]	1.932 [49.07]	1.800 [45.72]	.106 [2.69]	1.706 [43.33]	1-103166-7	1-102617-7	1-87579-6
40	2.112 [53.64]	2.032 [51.61]	1.900 [48.26]	.106 [2.69]	1.806 [45.87]	1-103166-8	1-102617-8	1-87579-7
42	2.212 [56.18]	2.132 [54.15]	2.000 [50.80]	.106 [2.69]	1.906 [48.41]	1-103166-9	1-102617-9	1-87579-8
44	2.312 [58.72]	2.232 [56.69]	2.100 [53.34]	.106 [2.69]	2.006 [50.95]	2-103166-0	2-102617-0	1-87579-9
46	2.412 [61.26]	2.332 [59.23]	2.200 [55.88]	.106 [2.69]	2.106 [53.49]	2-103166-1	2-102617-1	2-87579-0
48	2.512 [63.80]	2.432 [61.77]	2.300 [58.42]	.106 [2.69]	2.206 [56.03]	2-103166-2	2-102617-2	2-87579-1
50	2.612 [66.34]	2.532 [64.31]	2.400 [60.96]	.106 [2.69]	2.306 [58.57]	2-103166-3	2-102617-3	2-87579-2
52	2.712 [68.88]	2.632 [66.85]	2.500 [63.50]	.106 [2.69]	2.406 [61.11]	2-103166-4	2-102617-4	2-87579-3
54	2.812 [71.42]	2.732 [69.39]	2.600 [66.04]	.106 [2.69]	2.506 [63.65]	2-103166-5	2-102617-5	2-87579-4
56	2.912 [73.96]	2.832 [71.93]	2.700 [68.58]	.106 [2.69]	2.606 [66.19]	2-103166-6	2-102617-6	2-87579-5
58	3.012 [76.50]	2.932 [74.47]	2.800 [71.12]	.106 [2.69]	2.706 [68.73]	2-103166-7	2-102617-7	2-87579-6
60	3.112 [79.04]	3.032 [77.01]	2.900 [73.66]	.106 [2.69]	2.806 [71.27]	2-103166-8	2-102617-8	2-87579-7
62	3.212 [81.58]	3.132 [79.55]	3.000 [76.20]	.106 [2.69]	2.906 [73.81]	2-103166-9	2-102617-9	2-87579-8
64	3.312 [84.12]	3.232 [82.09]	3.100 [78.74]	.106 [2.69]	3.006 [76.35]	3-103166-0	3-102617-0	2-87579-9
66	3.412 [86.66]	3.332 [84.63]	3.200 [81.28]	.106 [2.69]	3.106 [78.89]	3-103166-1	3-102617-1	3-87579-0
68	3.512 [89.20]	3.432 [87.17]	3.300 [83.82]	.106 [2.69]	3.206 [81.43]	3-103166-2	3-102617-2	3-87579-1
70	3.612 [91.74]	3.532 [89.71]	3.400 [86.36]	.106 [2.69]	3.306 [83.97]	3-103166-3	3-102617-3	3-87579-2
72	3.712 [94.28]	3.632 [92.25]	3.500 [88.90]	.106 [2.69]	3.406 [86.51]	3-103166-4	3-102617-4	3-87579-3
74	3.812 [96.82]	3.732 [94.79]	3.600 [91.44]	.106 [2.69]	3.506 [89.05]	3-103166-5	3-102617-5	3-87579-4

Standard Profile Headers—Shrouded, with .150 [3.81] End Dimension, Double-Row, .100 x .100 [2.54 x 2.54] Centerline

.025 [0.64] Square Right-Angle Post (with Detent Windows)



Material and Finish:

Housing—Black thermoplastic, 94V-0 rated

Posts—Copper alloy, plated as follows:

Plating A—Duplex plated .000030 [0.00076] gold on contact area, .000100-.000200 [0.00254-0.00508] tin-lead on solder area, with entire post underplated .000050 [0.00127] nickel

Plating B—Duplex plated .000015 [0.00038] gold on contact area, .000100-.000200 [0.00254-0.00508] tin-lead on solder area, with entire post underplated .000050 [0.00127] nickel

Plating C—.000100-.000200 [0.00254-0.00508] tin-lead over .000050 [0.00127] nickel on entire post

Related Product Data:

Mateable Connectors:

AMPMODU MTE Receptacles—pages 249, 250, 252 (used with coupling shroud on page 258)

AMPMODU Wire-Applied Receptacles—pages 233-236

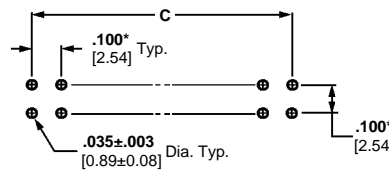
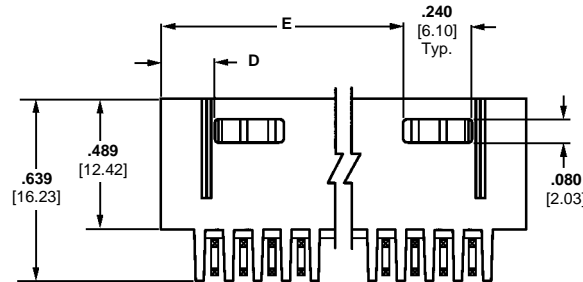
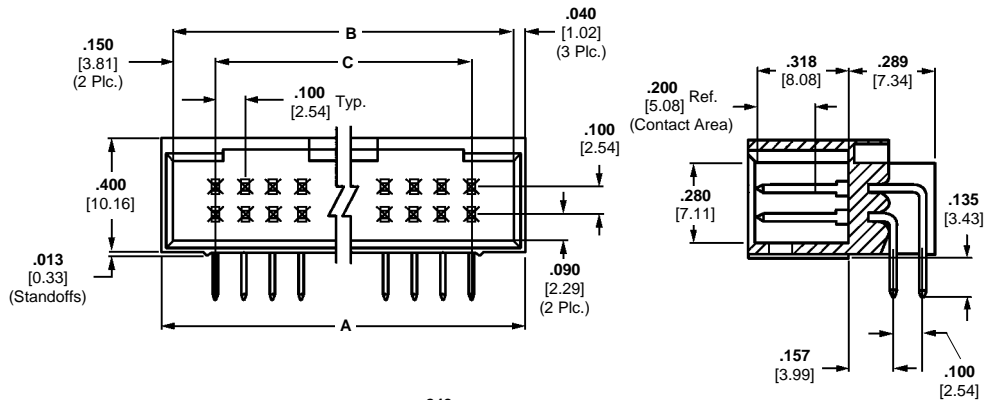

Recommended PC Board Hole Layout (for .055 [1.40] min. thick PC board)

*±.003 [±0.08] tolerances not to accumulate within one connector pattern.

Technical Documents (page 294):

See mating connector for applicable product and application specifications.

No. of Pos.	Dimensions					Post Plating/Part Nos.		
	A	B	C	D	E	Plating A	Plating B	Plating C
8	.680 [17.27]	.600 [15.24]	.300 [7.62]	.190 [4.83]	—	103167-1	102570-2	87577-1
10	.780 [19.81]	.700 [17.78]	.400 [10.16]	.290 [7.37]	—	103167-2	102570-3	87577-2
12	.880 [22.35]	.800 [20.32]	.500 [12.70]	.290 [7.37]	—	103167-3	102570-4	87577-3
14	.980 [24.89]	.900 [22.86]	.600 [15.24]	.390 [9.91]	—	103167-4	102570-5	87577-4
16	1.080 [27.43]	1.000 [25.40]	.700 [17.78]	.390 [9.91]	—	103167-5	102570-6	87577-5
18	1.180 [29.97]	1.100 [27.94]	.800 [20.32]	.490 [12.45]	—	103167-6	102570-7	87577-6
20	1.280 [32.51]	1.200 [30.48]	.900 [22.86]	.190 [4.83]	.890 [22.61]	103167-7	102570-8	87577-7
22	1.380 [35.05]	1.300 [33.02]	1.000 [25.40]	.190 [4.83]	.990 [25.15]	103167-8	102570-9	87577-8
24	1.480 [37.59]	1.400 [35.56]	1.100 [27.94]	.190 [4.83]	1.090 [27.69]	103167-9	1-102570-0	87577-9
26	1.580 [40.13]	1.500 [38.10]	1.200 [30.48]	.190 [4.83]	1.190 [30.23]	1-103167-0	1-102570-1	1-87577-0
28	1.680 [42.67]	1.600 [40.64]	1.300 [33.02]	.190 [4.83]	1.290 [32.77]	1-103167-1	1-102570-2	1-87577-1
30	1.780 [45.21]	1.700 [43.18]	1.400 [35.56]	.190 [4.83]	1.390 [35.31]	1-103167-2	1-102570-3	1-87577-2

Standard Profile Headers, Shrouded

5

Standard Profile Headers—Shrouded, with .150 [3.81] End Dimension, Double-Row, .100 x .100 [2.54 x 2.54] Centerline (Continued)

No. of Pos.	Dimensions					Post Plating/Part Nos.		
	A	B	C	D	E	Plating A	Plating B	Plating C
32	1.880 [47.75]	1.800 [45.72]	1.500 [38.10]	.190 [4.83]	1.490 [37.85]	1-103167-3	1-102570-4	1-87577-3
34	1.980 [50.29]	1.900 [48.26]	1.600 [40.64]	.190 [4.83]	1.590 [40.39]	1-103167-4	1-102570-5	1-87577-4
36	2.080 [52.83]	2.000 [50.80]	1.700 [43.18]	.190 [4.83]	1.690 [42.93]	1-103167-5	1-102570-6	1-87577-5
38	2.180 [55.37]	2.100 [53.34]	1.800 [45.72]	.190 [4.83]	1.790 [45.47]	1-103167-6	1-102570-7	1-87577-6
40	2.280 [57.91]	2.200 [55.88]	1.900 [48.26]	.190 [4.83]	1.890 [48.01]	1-103167-7	102570-1	1-87577-7
42	2.380 [60.45]	2.300 [58.42]	2.000 [50.80]	.190 [4.83]	1.990 [50.55]	1-103167-8	1-102570-8	1-87577-8
44	2.480 [62.99]	2.400 [60.96]	2.100 [53.34]	.190 [4.83]	2.090 [53.09]	1-103167-9	1-102570-9	1-87577-9
46	2.580 [65.53]	2.500 [63.50]	2.200 [55.88]	.190 [4.83]	2.190 [55.63]	2-103167-0	2-102570-0	2-87577-0
48	2.680 [68.07]	2.600 [66.04]	2.300 [58.42]	.190 [4.83]	2.290 [58.17]	2-103167-1	2-102570-1	2-87577-1
50	2.780 [70.61]	2.700 [68.58]	2.400 [60.96]	.190 [4.83]	2.390 [60.71]	2-103167-2	2-102570-2	2-87577-2
52	2.880 [73.15]	2.800 [71.12]	2.500 [63.50]	.190 [4.83]	2.490 [63.25]	2-103167-3	2-102570-3	2-87577-3
54	2.980 [75.69]	2.900 [73.66]	2.600 [66.04]	.190 [4.83]	2.590 [65.79]	2-103167-4	2-102570-4	2-87577-4
56	3.080 [78.23]	3.000 [76.20]	2.700 [68.58]	.190 [4.83]	2.690 [68.33]	2-103167-5	2-102570-5	2-87577-5
58	3.180 [80.77]	3.100 [78.74]	2.800 [71.12]	.190 [4.83]	2.790 [70.87]	2-103167-6	2-102570-6	2-87577-6
60	3.280 [83.31]	3.200 [81.28]	2.900 [73.66]	.190 [4.83]	2.890 [73.41]	2-103167-7	2-102570-7	2-87577-7
62	3.380 [85.85]	3.300 [83.82]	3.000 [76.20]	.190 [4.83]	2.990 [75.95]	2-103167-8	2-102570-8	2-87577-8
64	3.480 [88.39]	3.400 [86.36]	3.100 [78.74]	.190 [4.83]	3.090 [78.49]	2-103167-9	2-102570-9	2-87577-9
66	3.580 [90.93]	3.500 [88.90]	3.200 [81.28]	.190 [4.83]	3.190 [81.03]	3-103167-0	3-102570-0	3-87577-0
68	3.680 [93.47]	3.600 [91.44]	3.300 [83.82]	.190 [4.83]	3.290 [83.57]	3-103167-1	3-102570-1	3-87577-1
70	3.780 [96.01]	3.700 [93.98]	3.400 [86.36]	.190 [4.83]	3.390 [86.11]	3-103167-2	3-102570-2	3-87577-2
72	3.880 [98.55]	3.800 [96.52]	3.500 [88.90]	.190 [4.83]	3.490 [88.65]	3-103167-3	3-102570-3	3-87577-3

Standard Profile Headers—Shrouded, with .066 [1.68] End Dimension, Double-Row, .100 x .100 [2.54 x 2.54] Centerline

.025 [0.64] Square Right-Angle Post (with Pin Protection on 3 Sides)

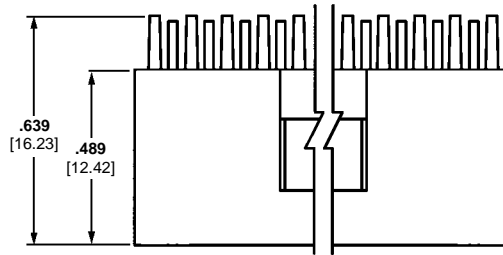
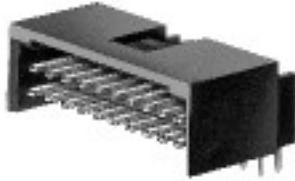

Material and Finish:

- Housing**—Black thermoplastic, 94V-0 rated
- Posts**—Copper alloy, plated as follows:
 - Plating A**—Duplex plated .000030 [0.00076] gold on contact area, .000100-.000200 [0.00254-0.00508] tin-lead on solder area, with entire post underplated .000050 [0.00127] nickel
 - Plating B**—Duplex plated .000015 [0.00038] gold on contact area, .000100-.000200 [0.00254-0.00508] tin-lead on solder area, with entire post underplated .000050 [0.00127] nickel
 - Plating C**—.000100-.000200 [0.00254-0.00508] tin-lead over .000050 [0.00127] nickel on entire post

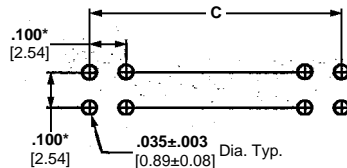
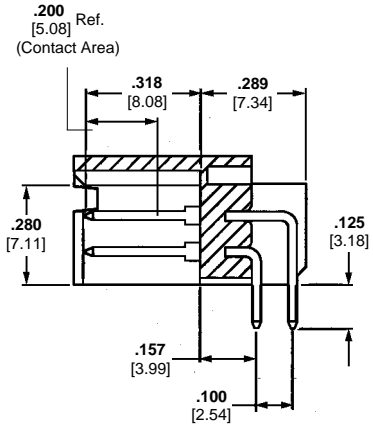
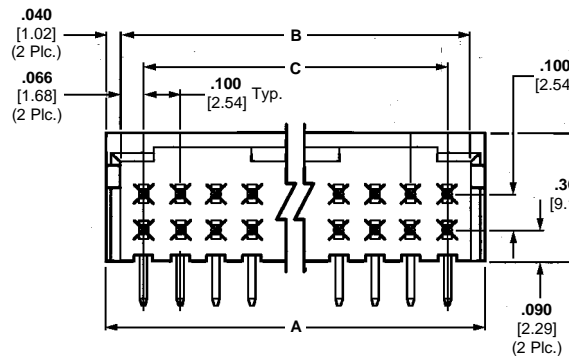

Recommended PC Board Hole Layout (for .055 [1.40] min. thick PC board)

*±.003 [±0.08] tolerances not to accumulate within one connector pattern.

Related Product Data:

- Mateable Connectors:**
 - AMPMODU Board Mount Receptacles**—pages 193, 196, 197
 - AMPMODU Wire-Applied Receptacles**—pages 233, 234
 - AMPMODU MTE Receptacles**—pages 245, 246, 251
 - AMPMODU MT Receptacles**—pages 275, 276

Technical Documents (page 294):

See mating connector for applicable product and application specifications.

No. of Pos.	Dimensions			Post Plating/Part Nos.		
	A	B	C	Plating A	Plating B	Plating C
6	.412 [10.46]	.332 [8.43]	.200 [5.08]	103164-1	102055-2	3-87572-5
8	.512 [13.00]	.432 [10.97]	.300 [7.62]	103164-2	102055-3	87572-1
10	.612 [15.54]	.532 [13.51]	.400 [10.16]	103164-3	102055-4	87572-2
12	.712 [18.08]	.632 [16.05]	.500 [12.70]	103164-4	102055-5	87572-3
14	.812 [20.62]	.732 [18.59]	.600 [15.24]	103164-5	102055-6	87572-4
16	.912 [23.16]	.832 [21.13]	.700 [17.78]	103164-6	102055-7	87572-5
18	1.012 [25.70]	.932 [23.67]	.800 [20.32]	103164-7	102055-8	87572-6
20	1.112 [28.24]	1.032 [26.21]	.900 [22.86]	103164-8	102055-1	87572-7
24	1.312 [33.32]	1.232 [31.29]	1.100 [27.94]	1-103164-0	1-102055-0	—
26	1.412 [35.86]	1.332 [33.83]	1.200 [30.48]	1-103164-1	—	1-87572-0
30	1.612 [40.94]	1.532 [38.91]	1.400 [35.56]	1-103164-3	1-102055-3	—
34	1.812 [46.02]	1.732 [43.99]	1.600 [40.64]	1-103164-5	1-102055-5	1-87572-4
40	2.112 [53.64]	2.032 [51.61]	1.900 [48.26]	1-103164-8	1-102055-8	1-87572-7
50	2.612 [66.34]	2.532 [64.31]	2.400 [60.96]	2-103164-3	2-102055-3	2-87572-2
52	2.712 [68.88]	2.632 [66.85]	2.500 [63.50]	2-103164-4	—	—
54	2.812 [71.42]	2.732 [69.36]	2.600 [66.04]	—	2-102055-5	—
60	3.112 [79.04]	3.032 [77.01]	2.900 [73.66]	2-103164-8	2-102055-8	2-87572-7

Standard Profile Headers—Shrouded, with .150 [3.81] End Dimension, Double-Row, .100 x .100 [2.54 x 2.54] Centerline

.025 [0.64] Square Right-Angle Post (with Pin Protection on 3 Sides)

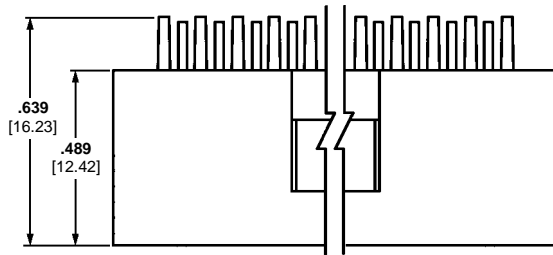
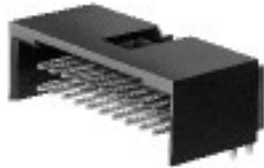

Material and Finish:

Housing—Black thermoplastic, 94V-0 rated

Posts—Copper alloy, plated as follows:

Plating A—Duplex plated .000030 [0.00076] gold on contact area, .000100-.000200 [0.00254-0.00508] tin-lead on solder area, with entire post underplated .000050 [0.00127] nickel

Plating B—Duplex plated .000015 [0.00038] gold on contact area, .000100-.000200 [0.00254-0.00508] tin-lead on solder area, with entire post underplated .000050 [0.00127] nickel

Plating C— .000100-.000200 [0.00254-0.00508] tin-lead over .000050 [0.00127] nickel on entire post

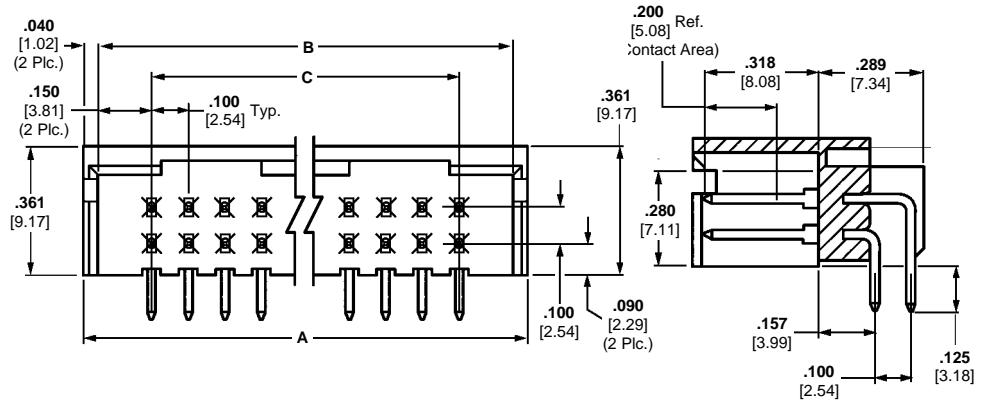

Related Product Data:

Mateable Connectors:

AMPMODU Wire-Applied

Receptacles—pages 233, 234

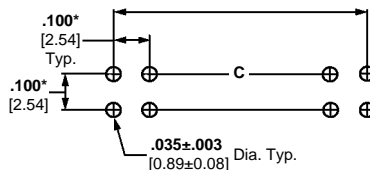

Recommended PC Board Hole Layout (for .055 [1.40] min. thick PC board)

*±.003 [±0.08] tolerances not to accumulate within one connector pattern.

Technical Documents (page 294):

See mating connector for applicable product and application specifications.

No. of Pos.	Dimensions			Post Plating/Part Nos.		
	A	B	C	Plating A	Plating B	Plating C
10	.780 [19.81]	.700 [17.78]	.400 [10.16]	103165-1	102620-1	87568-1
12	.880 [22.35]	.800 [20.32]	.500 [12.70]	103165-2	102620-2	87568-2
14	.980 [24.89]	.900 [22.86]	.600 [15.24]	103165-3	102620-3	87568-3
16	1.080 [27.43]	1.000 [25.40]	.700 [17.78]	103165-4	102620-4	87568-4
18	1.180 [29.97]	1.100 [27.94]	.800 [20.32]	103165-5	102620-5	87568-5
20	1.280 [32.51]	1.200 [30.48]	.900 [22.86]	103165-6	102620-6	87568-6
24	1.480 [37.59]	1.400 [35.56]	1.100 [27.94]	103165-8	102620-8	—
26	1.580 [40.13]	1.500 [38.10]	1.200 [30.48]	103165-9	102620-9	87568-9
30	1.780 [45.21]	1.700 [43.18]	1.400 [35.56]	1-103165-1	1-102620-1	—
34	1.980 [50.29]	1.900 [48.26]	1.600 [40.64]	1-103165-3	1-102620-3	1-87568-3
40	2.280 [57.91]	2.200 [55.88]	1.900 [48.26]	1-103165-6	1-102620-6	1-87568-6
50	2.780 [70.61]	2.700 [68.58]	2.400 [60.96]	2-103165-1	2-102620-1	2-87568-1
60	3.280 [83.31]	3.200 [81.28]	2.900 [73.66]	2-103165-6	2-102620-6	2-87568-6

Standard Profile Headers, Shrouded

5

Standard Profile Headers—Shrouded, with .150 [3.81] End Dimension, Double-Row, .100 x .100 [2.54 x 2.54] Centerline

.025 [0.64] Square Right-Angle Post (with Plastic Holddowns)



Photo 98185-9

Material and Finish:

Housing—Black thermoplastic, 94V-0 rated

Posts—Copper alloy, duplex plated .000015 [0.00038] gold on contact area, .000100-.000200 [0.00254-0.00508] tin-lead on solder area, with entire post underplated .000050 [0.00127] nickel

Related Product Data:

Mateable Connectors:

AMPMODU MTE Receptacles—pages 249, 250, 252 (used with coupling shroud on page 258)

AMPMODU Wire-Applied Receptacles—pages 233-236

Technical Documents (page 294):

See mating connector for applicable product and application specifications.

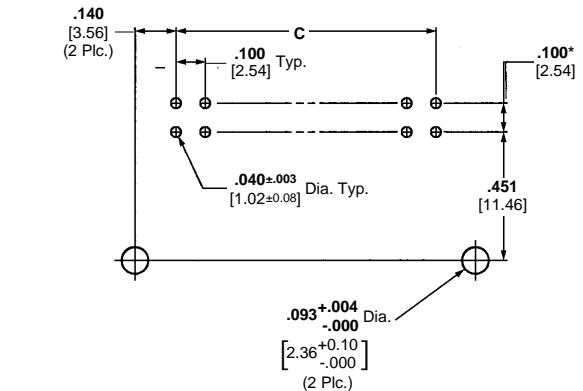
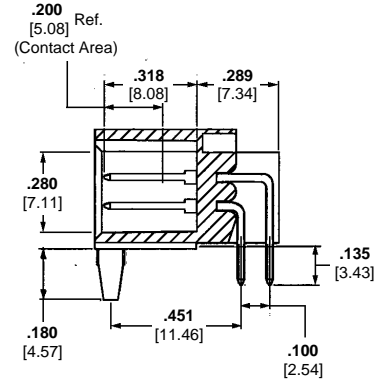
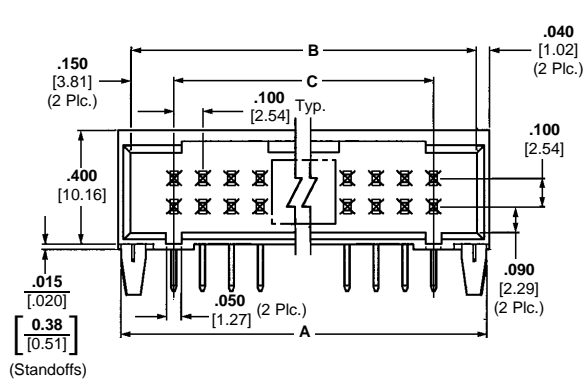
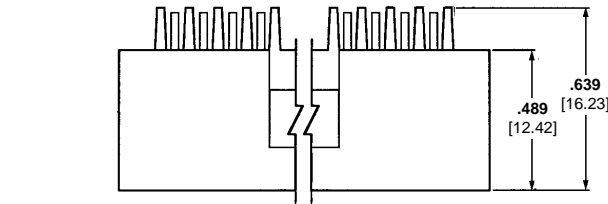

Recommended PC Board Hole Layout (for .055 [1.40] min. thick PC board)

*±.003 [±0.08] tolerances not to accumulate within one connector pattern.

No. of Pos.	Dimensions			Part Nos.
	A	B	C	
10	.780 [19.81]	.700 [17.78]	.400 [10.16]	104319-7
12	.880 [22.35]	.800 [20.32]	.500 [12.70]	104319-8
14	.980 [24.89]	.900 [22.86]	.600 [15.24]	104319-5
16	1.080 [27.43]	1.000 [25.40]	.700 [17.78]	104319-1
20	1.280 [32.51]	1.200 [30.48]	.900 [20.86]	104319-2
30	1.780 [45.21]	1.700 [43.18]	1.400 [35.56]	104319-3
34	1.980 [50.29]	1.900 [48.26]	1.600 [40.64]	104319-6
40	2.280 [57.91]	2.200 [55.88]	1.900 [48.26]	104319-4
48	2.680 [68.07]	2.600 [66.04]	2.300 [58.42]	104319-9

Standard Profile Headers, Shrouded

5

Standard Profile Headers—Shrouded, with .150 [3.81] End Dimension, Double-Row, .100 x .100 [2.54 x 2.54] Centerline (Continued)

.025 [0.64] Square Straight Post (with Detent Windows and Mounting Ears)



Material and Finish:

Housing—Black thermoplastic, 94V-0 rated

Posts—Copper alloy, plated .000030 [0.00076] gold over .000050 [0.00127] nickel on entire post

Related Product Data:

Mateable Connectors:

AMPMODU Wire-Applied Receptacles—pages 233-236

AMPMODU MTE Receptacles—pages 249, 250, 252 (used with coupling shroud on page 258)

Accessories:

Barrier Insert—page 221

Technical Documents (page 294):

See mating connector for applicable product and application specifications.

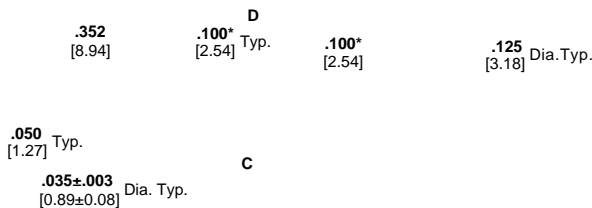
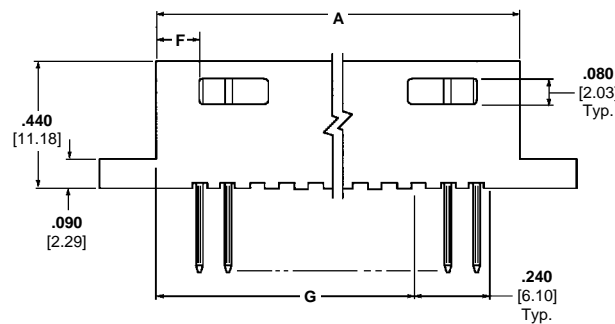
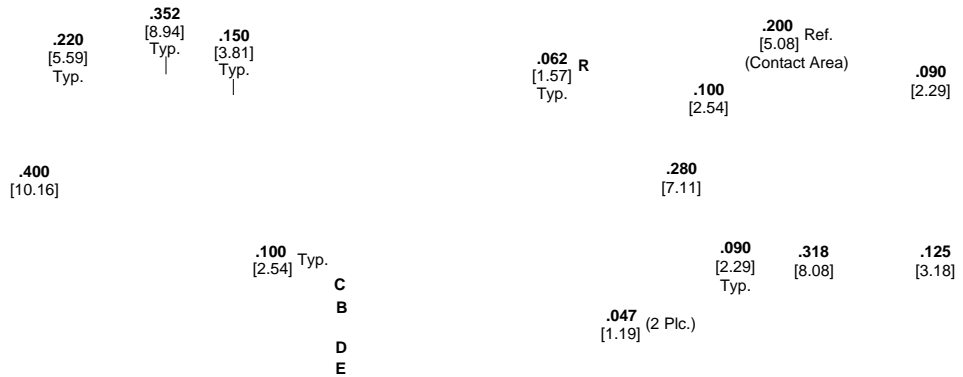

Recommended PC Board Hole Layout (for .055 [1.40] min. thick PC board)

*±.003 [±0.08] tolerances not to accumulate within one connector pattern.

No. of Pos.	Dimensions							Part Nos.
	A	B	C	D	E	F	G	
10	.780 [19.81]	.700 [17.78]	.400 [10.16]	1.104 [28.04]	1.304 [33.12]	.290 [7.37]	—	87474-1
14	.980 [24.89]	.900 [22.86]	.600 [15.24]	1.304 [33.12]	1.504 [38.20]	.190 [4.83]	—	87474-9
20	1.280 [32.51]	1.200 [30.48]	.900 [22.86]	1.604 [40.74]	1.804 [45.82]	.190 [4.83]	.890 [22.61]	87474-2
24	1.480 [37.59]	1.400 [35.56]	1.100 [27.94]	1.804 [45.82]	2.004 [50.90]	.190 [4.83]	1.090 [27.69]	1-87474-3
26	1.580 [40.13]	1.500 [38.10]	1.200 [30.48]	1.904 [48.36]	2.104 [53.44]	.190 [4.83]	1.190 [30.23]	87474-3
34	1.980 [50.29]	1.900 [48.26]	1.600 [40.64]	2.304 [58.52]	2.504 [63.60]	.190 [4.83]	1.590 [40.39]	87474-4
40	2.280 [57.91]	2.200 [55.88]	1.900 [48.26]	2.604 [66.14]	2.804 [71.22]	.190 [4.83]	1.890 [48.01]	87474-6
50	2.780 [70.61]	2.700 [68.58]	2.400 [60.96]	3.104 [78.84]	3.304 [83.92]	.190 [4.83]	2.390 [60.71]	87474-7
60	3.280 [83.31]	3.200 [81.28]	2.900 [73.66]	3.604 [91.54]	3.804 [96.62]	.190 [4.83]	2.890 [73.41]	2-87474-6

Standard Profile Headers, Shrouded

5

Standard Profile Headers—Shrouded Bulkhead Type; with .066 [1.68] End Dimension, Double-Row, .100 x .100 [2.54 x 2.45] Centerline

.025 [0.64] Square Straight Post (with Detent Windows and Mounting Ears)

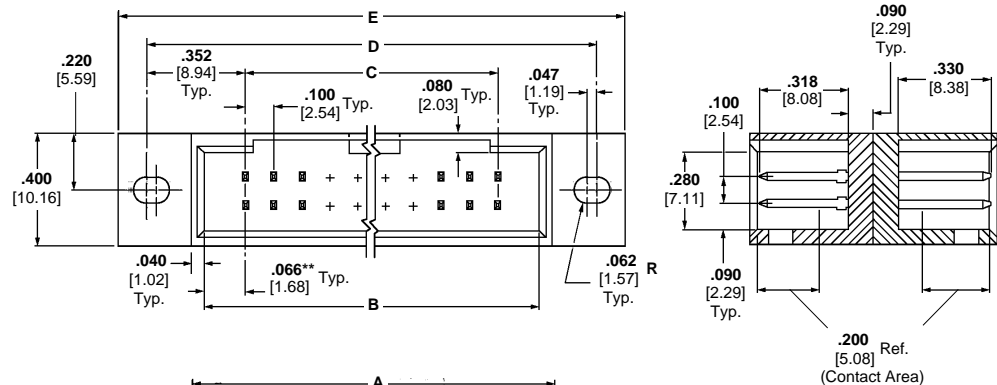

Material and Finish:

Housing—Black thermoplastic, 94V-0 rated

Posts—Copper alloy, plated .000030 [0.00076] gold over .000050 [0.00127] nickel on entire post

Related Product Data:

Mateable Connectors:
AMPMODU Board Mount Receptacles—pages 193, 196, 197

AMPMODU Wire-Applied Receptacles—pages 233-236

AMPMODU MTE Receptacles—pages 245, 246, 251

AMPMODU MT Receptacles—pages 275, 276

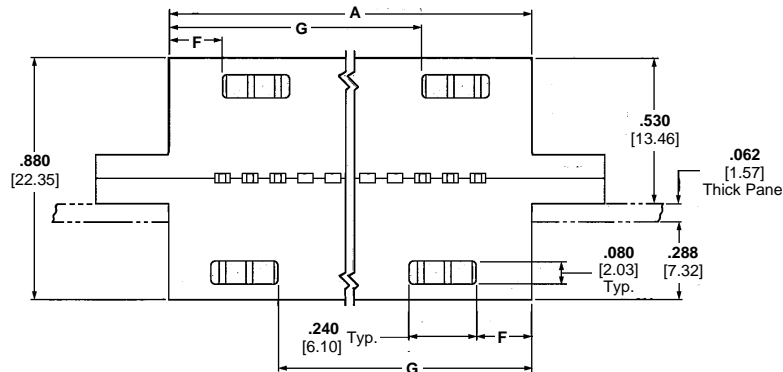

Accessories:

Barrier Insert—page 221

Technical Documents (page 294):

See mating connector for applicable product and application specifications.

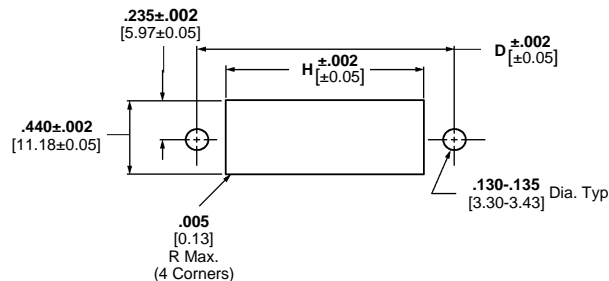

Recommended Panel Cutout

**Both mating faces have same end dimension.

No. of Pos.	Dimensions								Part Nos.
	A	B	C	D	E	F	G	H	
10	.612 [15.54]	.532 [13.51]	.400 [10.16]	1.104 [28.04]	1.304 [33.12]	.206 [5.23]	—	.632 [16.05]	87608-1
12	.712 [18.08]	.632 [16.05]	.500 [12.70]	1.204 [30.58]	1.404 [35.66]	.206 [5.23]	—	.732 [18.59]	87608-2
20	1.112 [28.24]	1.032 [26.21]	.900 [22.86]	1.604 [40.74]	1.804 [45.82]	.106 [2.69]	.806 [20.47]	1.132 [28.75]	87608-6
24	1.312 [33.32]	1.232 [31.29]	1.100 [27.94]	1.804 [45.82]	2.004 [50.90]	.106 [2.69]	1.006 [25.55]	1.332 [33.83]	87608-8
26	1.412 [35.86]	1.332 [33.83]	1.200 [30.48]	1.904 [48.36]	2.104 [53.44]	.106 [2.69]	1.106 [28.09]	1.432 [36.37]	87608-9
34	1.812 [46.02]	1.732 [43.99]	1.600 [40.64]	2.304 [58.52]	2.504 [63.60]	.106 [2.69]	1.506 [38.25]	1.832 [46.53]	1-87608-3
40	2.112 [53.64]	2.032 [51.61]	1.900 [48.26]	2.604 [66.14]	2.804 [71.22]	.106 [2.69]	1.806 [45.87]	2.132 [54.15]	1-87608-6
50	2.612 [66.34]	2.532 [64.31]	2.400 [60.96]	3.104 [78.84]	3.304 [83.92]	.106 [2.69]	2.306 [58.57]	2.632 [66.85]	2-87608-1
60	3.112 [79.04]	3.032 [77.01]	2.900 [73.66]	3.604 [91.54]	3.804 [96.62]	.106 [2.69]	2.806 [71.27]	3.132 [79.55]	2-87608-6

Standard Profile Headers—Shrouded Bulkhead Type; with .150 [3.81] End Dimension, Double-Row, .100 x .100 [2.54 x 2.45] Centerline

.025 [0.64] Square Straight Post (with Detent Windows and Mounting Ears)

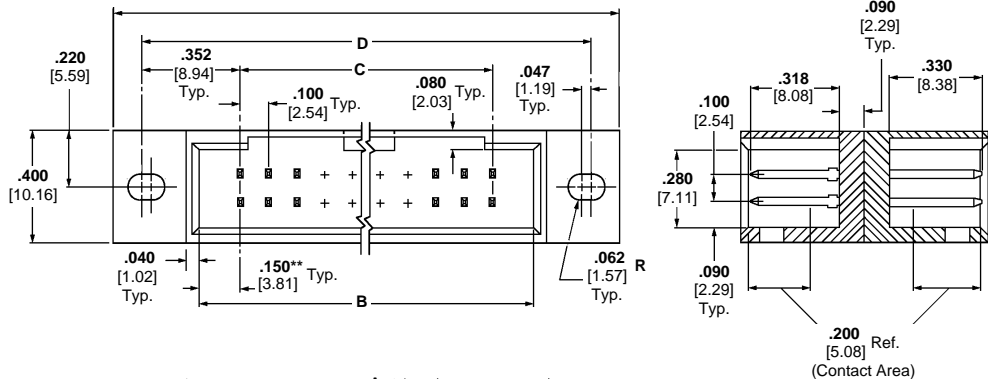

Material and Finish:

Housing—Black thermoplastic, 94V-0 rated

Posts—Copper alloy, plated .000030 [0.00076] gold over .000050 [0.00127] nickel on entire post

Related Product Data:

Mateable Connectors:

AMPMODU MTE Receptacles—pages 249, 250, 252 (used with coupling shroud on page 258)

AMPMODU Wire-Applied Receptacles—pages 233-236

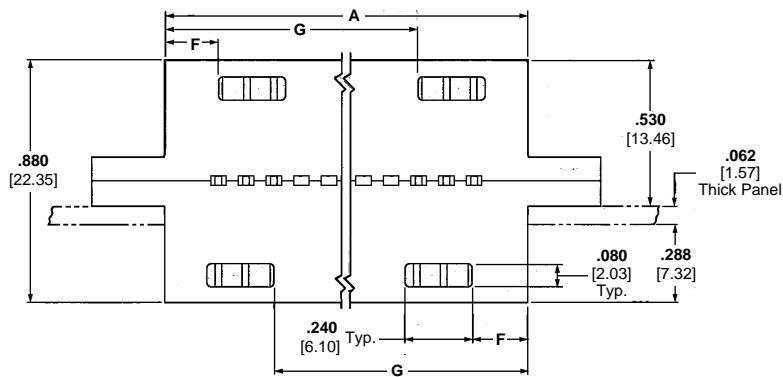

Accessories:

Barrier Insert—page 221

Technical Documents (page 294):

See mating connector for applicable product and application specifications.

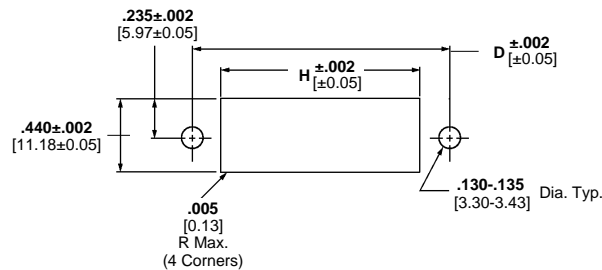

Recommended Panel Cutout

**Both mating faces have same end dimension.

No. of Pos.	Dimensions								Part Nos.
	A	B	C	D	E	F	G	H	
10	.780 [19.81]	.700 [17.78]	.400 [10.16]	1.104 [28.04]	1.304 [33.12]	.290 [7.37]	—	.800 [20.32]	87605-1
20	1.280 [32.51]	1.200 [30.48]	.900 [22.86]	1.604 [40.74]	1.804 [45.82]	.190 [4.83]	.890 [22.61]	1.300 [33.02]	87605-6
24	1.480 [37.59]	1.400 [35.56]	1.100 [27.94]	1.804 [45.82]	2.004 [50.90]	.190 [4.83]	1.090 [27.69]	1.500 [38.10]	87605-8
26	1.580 [40.13]	1.500 [38.10]	1.200 [30.48]	1.904 [48.36]	2.104 [53.44]	.190 [4.83]	1.190 [30.23]	1.600 [40.64]	87605-9
30	1.780 [45.21]	1.700 [43.18]	1.400 [35.56]	2.104 [53.44]	2.304 [58.52]	.190 [4.83]	1.390 [35.31]	1.800 [45.72]	1-87605-1
32	1.880 [47.75]	1.800 [45.72]	1.500 [38.10]	2.204 [55.98]	2.404 [61.06]	.190 [4.83]	1.490 [37.85]	1.900 [48.26]	1-87605-2
34	1.980 [50.29]	1.900 [48.26]	1.600 [40.64]	2.304 [58.52]	2.504 [63.60]	.190 [4.83]	1.590 [40.39]	2.000 [50.80]	1-87605-3
40	2.280 [57.91]	2.200 [55.88]	1.900 [48.26]	2.604 [66.14]	2.804 [71.22]	.190 [4.83]	1.890 [48.01]	2.300 [58.42]	1-87605-6
50	2.780 [70.61]	2.700 [68.58]	2.400 [60.96]	3.104 [78.84]	3.304 [83.92]	.190 [4.83]	2.390 [60.71]	2.800 [71.12]	2-87605-1
60	3.280 [83.31]	3.200 [81.28]	2.900 [73.66]	3.604 [91.54]	3.804 [96.62]	.190 [4.83]	2.890 [73.41]	3.300 [83.82]	2-87605-6

Standard Profile Headers, Shrouded

5

Standard Profile Headers—Shrouded Bulkhead Type; with .066/.150 [1.68/3.81] End Dimension, Double-Row, .100 x .100 [2.54 x 2.45] Centerline

.025 [0.64] Square Straight Post (with Detent Windows and Mounting Ears)

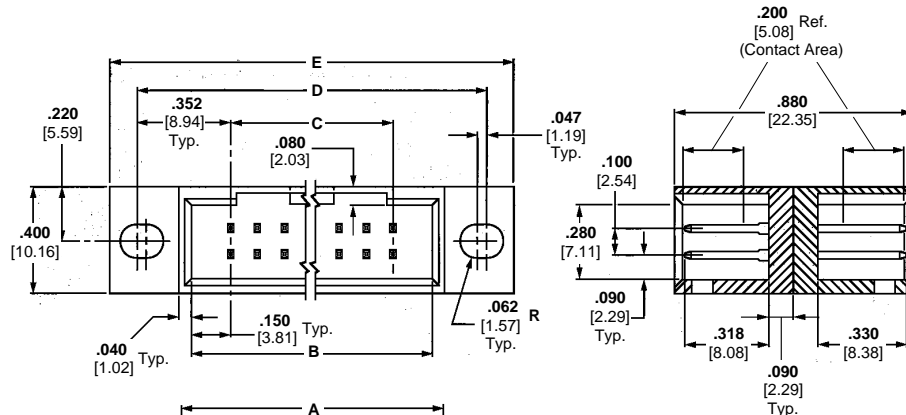

Material and Finish:

Housing—Black thermoplastic, 94V-0 rated

Posts—Copper alloy, plated .000030 [0.00076] gold over .000050 [0.00127] nickel on entire post

Related Product Data:

Mateable Connectors with .066 [1.68] End Dimension:

AMPMODU Board Mount Receptacles—pages 193, 196, 197

AMPMODU Wire-Applied Receptacles—pages 233-236

AMPMODU MTE Receptacles—pages 245, 246, 251

AMPMODU MT Receptacles—pages 275, 276

Mateable Connectors with .150 [3.81] End Dimension:

AMPMODU MTE Receptacles—pages 249, 250, 252 (used with coupling shroud on page 258)

Accessories:

Barrier Insert—page 221

Technical Documents (page 294):

See mating connector for applicable product and application specifications.

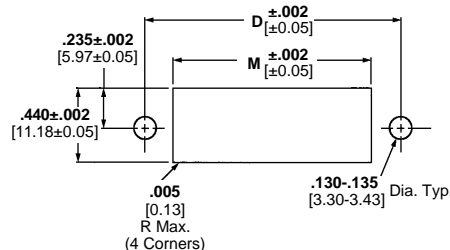
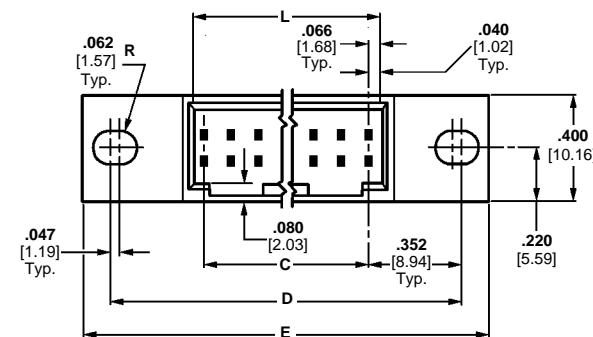
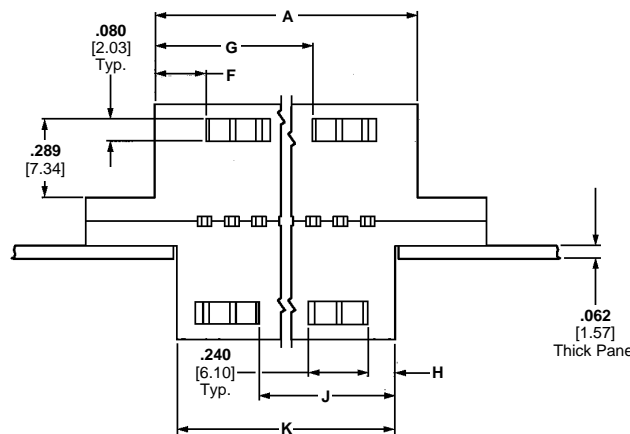

Recommended Panel Cutout

Standard Profile Headers, Shrouded

5

Standard Profile Headers—Shrouded Bulkhead Type; with .066/.150 [1.68/3.81] End Dimension, Double-Row, .100 x .100 [2.54 x 2.45] Centerline (Continued)

No. of Pos.	Dimensions						Part Nos.
	A	B	C	D	E	F	
10	.780 [19.81]	.700 [17.78]	.400 [10.16]	1.104 [28.04]	1.304 [33.12]	.290 [7.37]	87496-2
20	1.280 [32.51]	1.200 [30.48]	.900 [22.86]	1.604 [40.74]	1.804 [45.82]	.190 [4.83]	87496-7
24	1.480 [37.59]	1.400 [35.56]	1.100 [27.94]	1.804 [45.82]	2.004 [50.90]	.190 [4.83]	87496-9
26	1.580 [40.13]	1.500 [38.10]	1.200 [30.48]	1.904 [48.36]	2.104 [53.44]	.190 [4.83]	1-87496-0
30	1.780 [45.21]	1.700 [43.18]	1.400 [35.56]	2.104 [53.44]	2.304 [58.52]	.190 [4.83]	1-87496-2
34	1.980 [50.29]	1.900 [48.26]	1.600 [40.64]	2.304 [58.52]	2.504 [63.60]	.190 [4.83]	1-87496-4
40	2.280 [57.91]	2.200 [55.88]	1.900 [48.26]	2.604 [66.14]	2.804 [71.22]	.190 [4.83]	1-87496-7
50	2.780 [70.61]	2.700 [68.58]	2.400 [60.96]	3.304 [83.92]	3.304 [83.92]	.190 [4.83]	87496-1
60	3.280 [83.31]	3.200 [81.38]	2.900 [73.66]	3.604 [91.54]	3.804 [96.62]	.190 [4.83]	2-87496-6



No. of Pos.	Dimensions						Part Nos.
	G	H	J	K	L	M	
10	—	.206 [5.23]	—	.612 [15.54]	.532 [13.51]	.632 [16.05]	87496-2
20	.890 [22.61]	.106 [2.69]	.806 [20.47]	1.112 [28.24]	1.032 [26.21]	1.132 [28.75]	87496-7
24	1.090 [27.69]	.106 [2.69]	1.006 [25.55]	1.312 [33.32]	1.232 [31.29]	1.332 [33.83]	87496-9
26	1.190 [30.23]	.106 [2.69]	1.106 [28.09]	1.412 [35.86]	1.332 [33.83]	1.432 [36.37]	1-87496-0
30	1.390 [35.31]	.106 [2.69]	1.306 [33.17]	1.612 [40.94]	1.532 [38.91]	1.632 [41.45]	1-87496-2
34	1.590 [40.39]	.106 [2.69]	1.506 [38.25]	1.812 [46.02]	1.732 [43.99]	1.832 [46.53]	1-87496-4
40	1.890 [48.01]	.106 [2.69]	1.806 [45.87]	2.112 [53.64]	2.032 [51.61]	2.132 [54.15]	1-87496-7
50	2.390 [60.71]	.106 [2.69]	2.306 [58.57]	2.612 [66.34]	2.532 [64.31]	2.632 [66.85]	87496-1
60	2.890 [73.41]	.106 [2.69]	2.806 [71.27]	3.112 [79.04]	3.032 [77.01]	3.132 [79.55]	2-87496-6

Standard Profile Headers, Shrouded

5

AMP-LATCH Low Profile Headers—Shrouded

Product Facts

- Available in .000015 [0.00038] and .000030 [0.00076] gold duplex plated posts
- Available in selected positions 10 thru 60
- Flame retardant, thermoplastic housings, 94V-0 rated
- Vertical and right-angle versions available in double row configurations
- Available in .025 [0.64] square drawn wire posts
- Wash out clearance for flux removal
- Accepts center and double bar polarization housings
- Mates with AMP-LATCH Ribbon Cable Connectors
- Available with and without eject latches
- Available with and without high temperature compatible material
- Recognized under the Component Program of Underwriters Laboratories Inc.  File No. E28476
- Certified by Canadian Standards Association,  File No. LR 7189

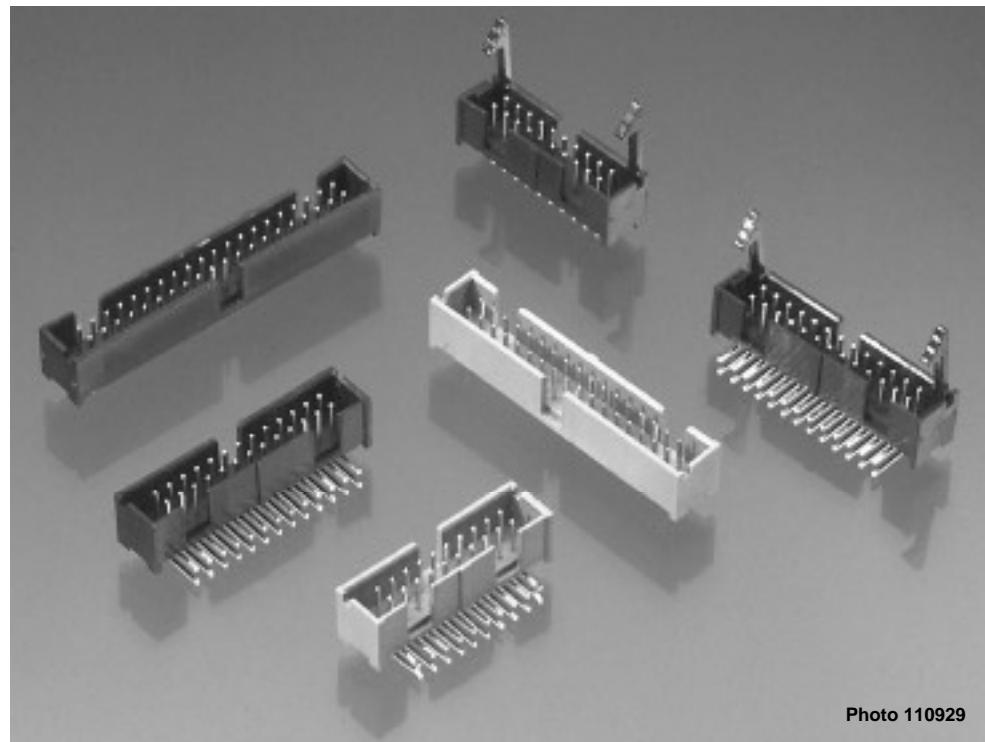

Photo 110929

Performance Characteristics

Electrical:

Insulation Resistance—5,000 megohms minimum initial
Dielectric Withstanding Voltage—750 V rms at sea level

Environmental:

Operating Temperature—-65°C to +105°C
Current—1 ampere maximum per contact

AMP-LATCH Low Profile Headers—Shrouded, with .150 [3.81] End Dimension, Double-Row, .100 x .100 [2.54 x 2.54] Centerline

.025 [0.64] Square Straight Post

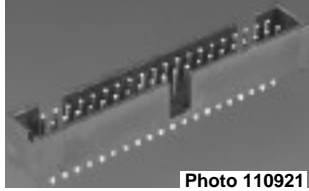

Photo 110921

Material and Finish:

Housing—Black thermoplastic, 94V-0 rated

Posts—Copper alloy, plated as follows:

Plating A—Duplex plated .000030 [0.00076] gold on contact area, .000100-.000200 [0.00254-0.00508] tin-lead on solder area, with entire post underplated .000050 [0.00127] nickel

Plating B—Duplex plated .000015 [0.00038] gold on contact area, .000100-.000200 [0.00254-0.00508] tin-lead on solder area, with entire post underplated .000050 [0.00127] nickel

Related Product Data:

Electrical Characteristics—page 151

Mateable Connectors:

AMPMODU Wire-Applied Receptacles—page 237

AMPMODU Board Mount Receptacles—pages 196, 197

Short Point Wire-Applied Connectors—page 241

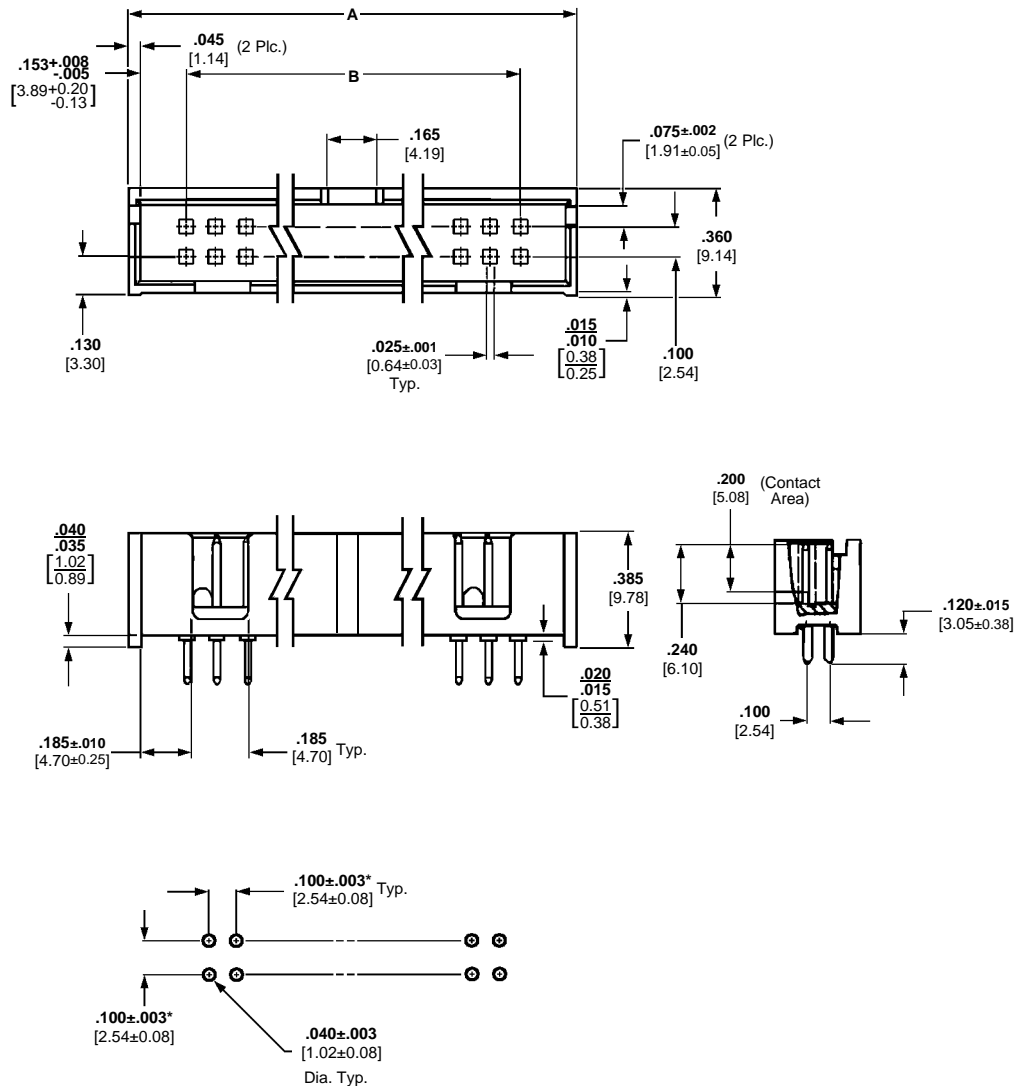

Recommended PCBoard Hole Layout For Manual Insertion

*±.003 [±0.08] tolerances not to accumulate within one connector pattern.

No. of Pos.	Dimensions		Post Plating/Part Nos.	
	A	B	Plating A	Plating B
10	.800 [20.32]	.400 [10.16]	103309-1	103308-1
14	1.000 [25.40]	.600 [15.24]	103309-2	103308-2
16	1.100 [27.94]	.700 [17.78]	103309-3	103308-3
20	1.300 [33.02]	.900 [22.86]	103309-5	103308-5
26	1.600 [40.64]	1.200 [30.48]	103309-6	103308-6
34	2.000 [50.80]	1.600 [40.64]	103309-7	103308-7
40	2.300 [58.42]	1.900 [48.26]	103309-8	103308-8
44	2.500 [63.50]	2.100 [53.34]	—	103308-9
50	2.800 [71.12]	2.400 [60.96]	1-103309-0	1-103308-0
60	3.300 [83.82]	2.900 [73.66]	1-103309-2	1-103308-2

Low Profile Headers, Shrouded

5

AMP-LATCH Low Profile Headers—Shrouded, with .150 [3.81] End Dimension, Double-Row, .100 x .100 [2.54 x 2.54] Centerline (Continued)

.025 [0.64] Square Right-Angle Post

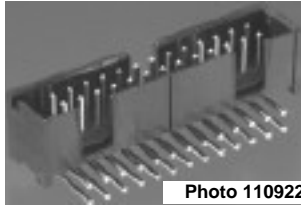
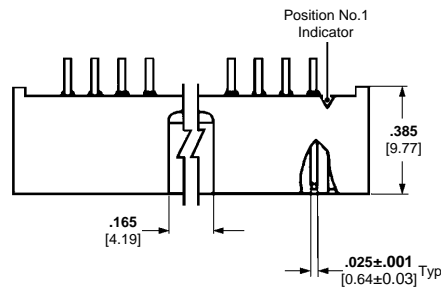

Photo 110922



Material and Finish:

Housing—Black thermoplastic, 94V-0 rated

Posts—Copper alloy, plated as follows:

Plating A—Duplex plated .000030 [0.00076] gold on contact area, .000100-.000200 [0.00254-0.00508] tin-lead on solder area, with entire post underplated .000050 [0.00127] nickel

Plating B—Duplex plated .000015 [0.00038] gold on contact area, .000100-.000200 [0.00254-0.00508] tin-lead on solder area, with entire post underplated .000050 [0.00127] nickel

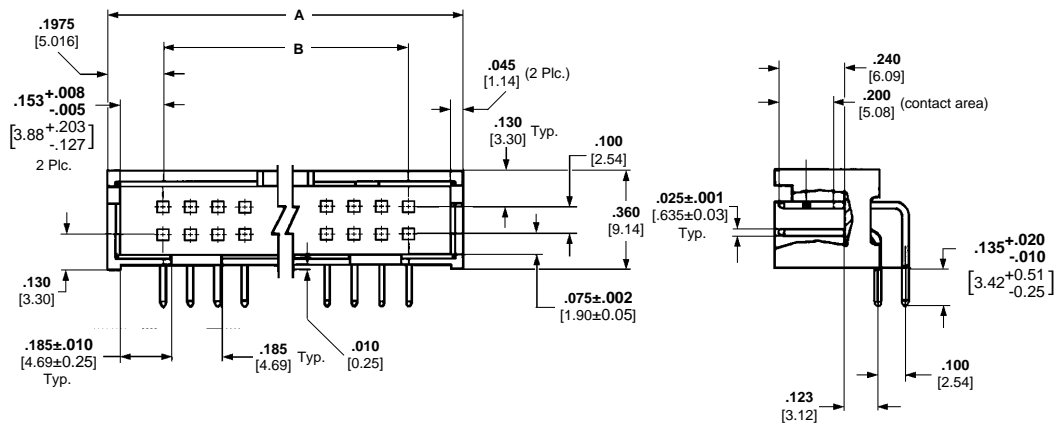

Related Product Data:

Electrical Characteristics—page 151

Mateable Connectors:
AMPMODU Wire-Applied Receptacles—page 237

Short Point Wire-Applied Connectors—page 241

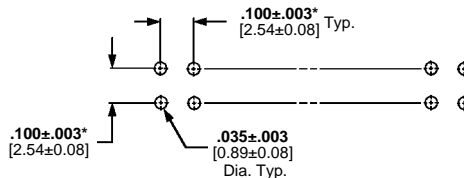

Recommended PC Board Hole Layout For Manual Insertion

*±.003 [±0.08] tolerances not to accumulate within one connector pattern.

No. of Pos.	Dimensions		Post Plating/Part Nos.	
	A	B	Plating A	Plating B
10	.800 [20.32]	.400 [10.16]	103311-1	103310-1
14	1.000 [25.40]	.600 [15.24]	103311-2	103310-2
16	1.100 [27.94]	.700 [17.78]	103311-3	103310-3
20	1.300 [33.02]	.900 [22.86]	103311-5	103310-5
26	1.600 [40.64]	1.200 [30.48]	103311-6	103310-6
34	2.000 [50.80]	1.600 [40.64]	103311-7	103310-7
40	2.300 [58.42]	1.900 [48.26]	103311-8	103310-8
44	2.500 [63.50]	2.100 [53.34]	103311-9	—
50	2.800 [71.12]	2.400 [60.96]	1-103311-0	1-103310-0
60	3.300 [83.82]	2.900 [73.66]	1-103311-2	1-103310-2

Low Profile Headers, Shrouded

5

AMP-LATCH Low Profile Headers—Shrouded High Temperature Housings*, with .150 [3.81] End Dimension, Double-Row, .100 x .100 [2.54 x 2.54] Centerline

.025 [0.64] Square Straight Post (with Board Retention Feature)

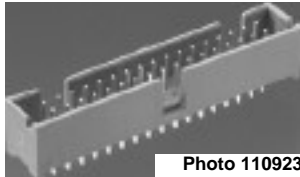

Photo 110923

Material and Finish:

Housing—Gray thermoplastic, 94V-0 rated

Posts—Copper alloy, plated as follows:

Plating—Duplex plated .000015 [0.00038] gold on contact area, .000100-.000200 [0.00254-0.00508] tin-lead on solder area, with entire post underplated .000050 [0.00127] nickel

Related Product Data:

Electrical Characteristics—page 151

Mateable Connectors:

AMPMODU Wire-Applied Receptacles—page 237

AMPMODU Board Mount Receptacles—pages 196, 197

Short Point Wire-Applied Connectors—page 241

*Reflow solder process compatible

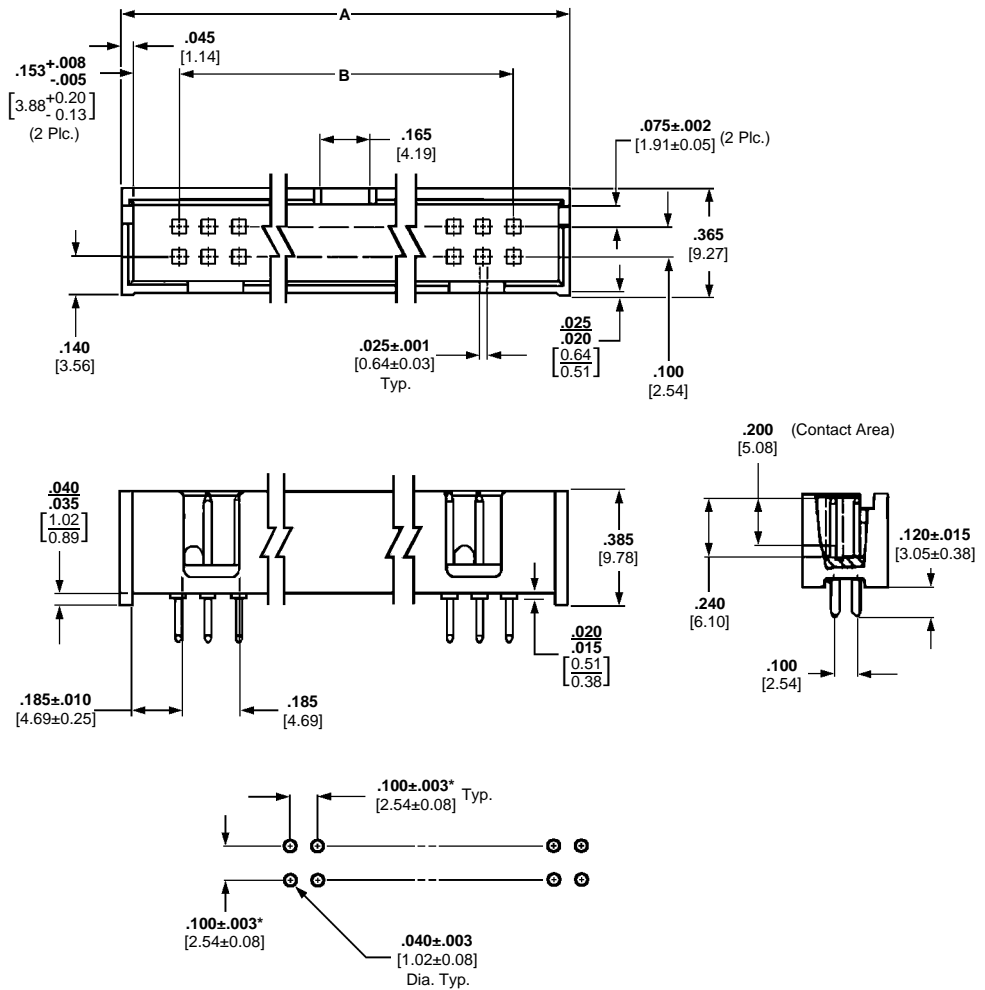

Recommended PC Board Hole Layout For Manual Insertion

*±.003 [±0.08] tolerances not to accumulate within one connector pattern.

No. of Pos.	Dimensions		Post Plating Part Nos.
	A	B	
10	.800 [20.32]	.400 [10.16]	104338-1
14	1.000 [25.40]	.600 [15.24]	104338-2
16	1.100 [27.94]	.700 [17.78]	104338-3
20	1.300 [33.02]	.900 [22.86]	104338-4
24	1.400 [35.56]	1.100 [27.94]	104338-5
34	2.000 [50.80]	1.600 [40.64]	104338-7
40	2.300 [58.42]	1.900 [48.26]	104338-8
50	2.800 [71.12]	2.400 [60.96]	104338-9
60	3.300 [83.82]	2.900 [73.66]	1-104338-0

Low Profile Headers, Shrouded

5

AMP-LATCH Low Profile Headers—Shrouded High Temperature Housings*, with .150 [3.81] End Dimension, Double-Row, .100 x .100 [2.54 x 2.54] Centerline (Continued)

.025 [0.64] Square Right-Angle Post (with Board Retention Feature)

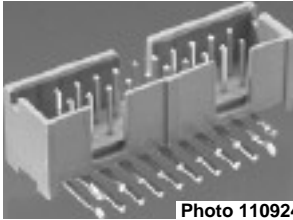

Photo 110924

Material and Finish:

Housing—Gray thermoplastic, 94V-0 rated

Posts—Copper alloy, plated as follows:

Plating—Duplex plated .000015 [0.00038] gold on contact area, .000100-.000200 [0.00254-0.00508] tin-lead on solder area, with entire post underplated .000050 [0.00127] nickel

Related Product Data:

Electrical Characteristics—page 151

Mateable Connectors:

AMPMODU Wire-Applied Receptacles—page 237

Short Point Wire-Applied Connectors—page 241

*Reflow solder process compatible

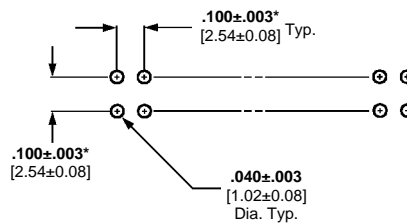
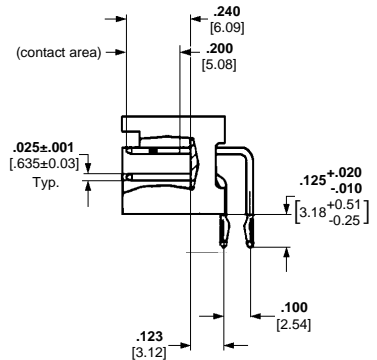
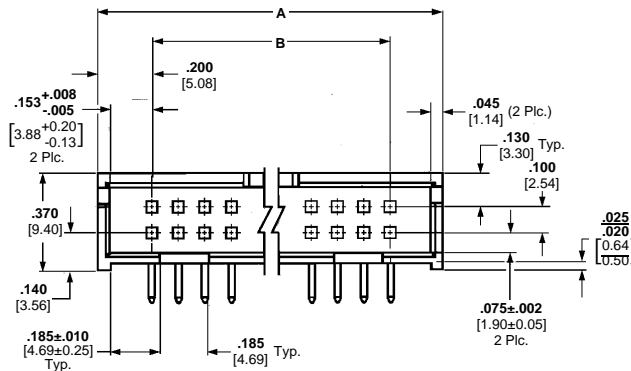
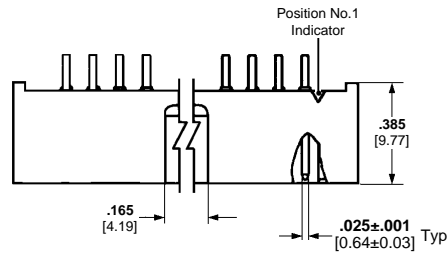

Recommended PC Board Hole Layout For Manual Insertion

*±.003 [±0.08] tolerances not to accumulate within one connector pattern.

No. of Pos.	Dimensions		Post Plating Part Nos.
	A	B	
10	.800 [20.32]	.400 [10.16]	104340-1
14	1.000 [25.40]	.600 [15.24]	104340-2
16	1.100 [27.94]	.700 [17.78]	104340-3
20	1.300 [33.02]	.900 [22.86]	104340-4
40	2.300 [58.42]	1.900 [48.26]	104340-8
50	2.800 [71.12]	2.400 [60.96]	104340-9

Low Profile Headers, Shrouded

5

AMP-LATCH Low Profile Headers—Shrouded with Ejection Latches and .150 [3.81] End Dimension, Double-Row, .100 x .100 [2.54 x 2.54] Centerline

.025 [0.64] Square Straight Post

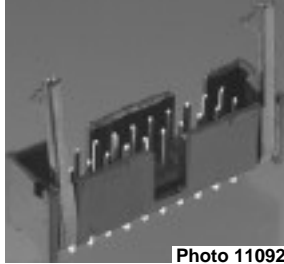

Photo 110926

Material and Finish:

Housing—Black thermoplastic, 94V-0 rated

Posts—Copper alloy, duplex plated .000030 [0.00076] gold on contact area, .000100-.000200 [0.00254-0.00508] tin-lead on solder area, with entire post underplated .000050 [0.00127] nickel

Related Product Data:

Electrical Characteristics—page 151

Mateable Connectors:
AMPMODU Wire-Applied Receptacles—page 237
 (For .585 [14.90] Latching Height)

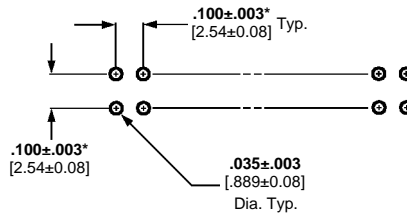
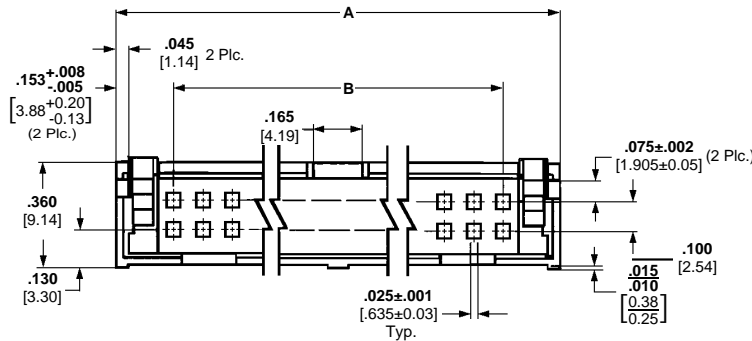
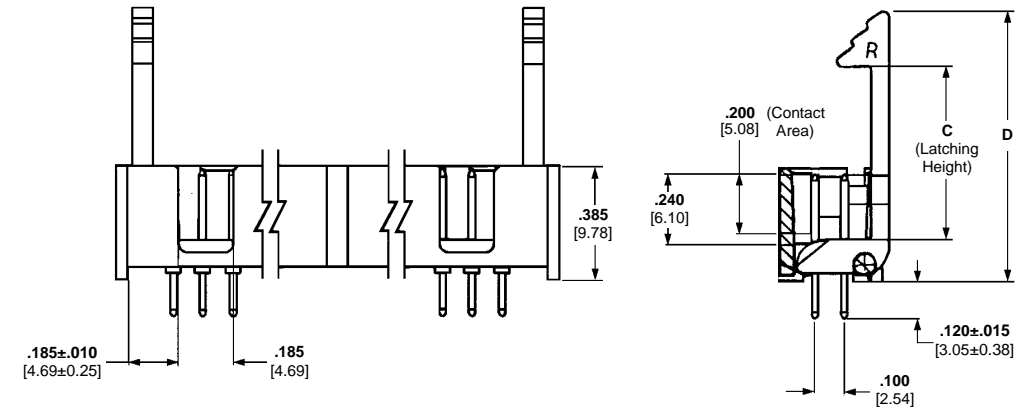

Recommended PC Board Hole Layout For Manual Insertion

*±.003 [±0.08] tolerances not to accumulate within one connector pattern.

No. of Pos.	Dimensions				Part Nos.
	A	B	C	D	
10	.800 [20.32]	.400 [10.16]	.585 [14.90]	.917 [23.29]	104128-1
			.437 [11.10]	.769 [19.53]	104313-1
14	1.000 [25.40]	.600 [15.24]	.585 [14.90]	.917 [23.29]	104128-2
			.437 [11.10]	.769 [19.53]	104313-2
16	1.100 [27.94]	.700 [17.78]	.585 [14.90]	.917 [23.29]	104128-3
			.437 [11.10]	.769 [19.53]	104313-3
20	1.300 [33.02]	.900 [22.86]	.585 [14.90]	.917 [23.29]	104128-4
			.437 [11.10]	.769 [19.53]	104313-4
26	1.600 [40.64]	1.200 [30.48]	.585 [14.90]	.917 [23.29]	104128-5
			.437 [11.10]	.769 [19.53]	104313-5
34	2.000 [50.80]	1.600 [40.64]	.585 [14.90]	.917 [23.29]	104128-6
			.437 [11.10]	.769 [19.53]	104313-6
40	2.300 [58.42]	1.900 [48.26]	.585 [14.90]	.917 [23.29]	104128-7
			.437 [11.10]	.769 [19.53]	104313-7
50	2.800 [71.12]	2.400 [60.96]	.585 [14.90]	.917 [23.29]	104128-9
			.437 [11.10]	.769 [19.53]	104313-9
60	3.300 [83.82]	2.900 [73.66]	.585 [14.90]	.917 [23.29]	1-104128-0
			.437 [11.10]	.769 [19.53]	1-104313-0

Low Profile Headers, Shrouded

5

AMP-LATCH Low Profile Headers—Shrouded with Ejection Latches and .150 [3.81] End Dimension, Double-Row, .100 x .100 [2.54 x 2.54] Centerline (Continued)

.025 [0.64] Square Right-Angle Post

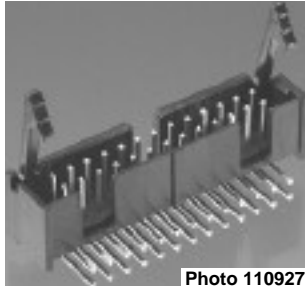

Photo 110927

Material and Finish:

Housing—Black thermoplastic, 94V-0 rated

Posts—Copper alloy, duplex plated .000030 [0.00076] gold on contact area, .000100-.000200 [0.00254-0.00508] tin-lead on solder area, with entire post underplated .000050 [0.00127] nickel

Related Product Data:

Electrical Characteristics—page 151

Mateable Connectors:

AMPMODU Wire-Applied Receptacles—page 237
(For .585 [14.90] Latching Height)

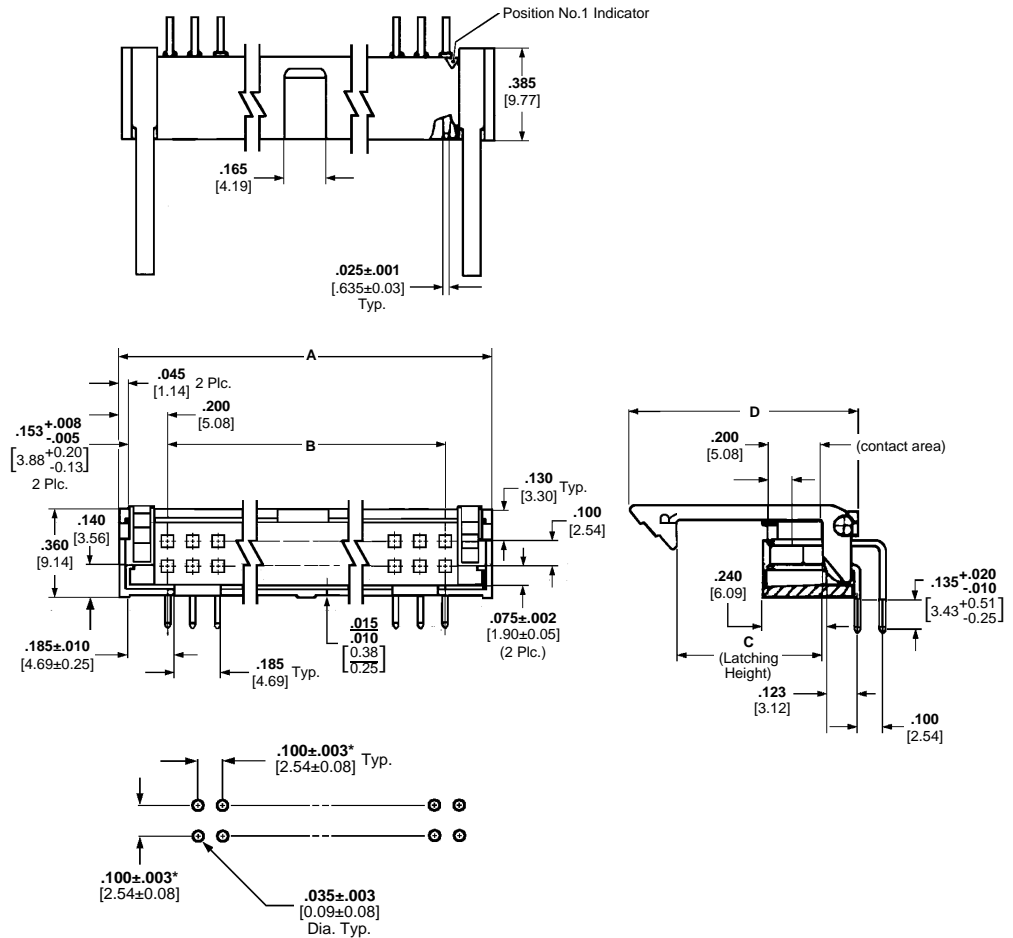

Recommended PC Board Hole Layout For Manual Insertion

*±.003 [±0.08] tolerances not to accumulate within one connector pattern.

No. of Pos.	Dimensions				Part Nos.
	A	B	C	D	
10	.800 [20.32]	.400 [10.16]	.585 [14.90] .437 [11.10]	.917 [23.29] .769 [19.53]	104130-1 104315-1
14	1.000 [25.40]	.600 [15.24]	.585 [14.90] .437 [11.10]	.917 [23.29] .769 [19.53]	104130-2 104315-2
16	1.100 [27.94]	.700 [17.78]	.585 [14.90] .437 [11.10]	.917 [23.29] .769 [19.53]	104130-3 104315-3
20	1.300 [33.02]	.900 [22.86]	.585 [14.90] .437 [11.10]	.917 [23.29] .769 [19.53]	104130-4 104315-4
26	1.600 [40.64]	1.200 [30.48]	.585 [14.90] .437 [11.10]	.917 [23.29] .769 [19.53]	104130-5 104315-5
34	2.000 [50.80]	1.600 [40.64]	.585 [14.90] .437 [11.10]	.917 [23.29] .769 [19.53]	104130-6 104315-6
40	2.300 [58.42]	1.900 [48.26]	.585 [14.90] .437 [11.10]	.917 [23.29] .769 [19.53]	104130-7 104315-7
50	2.800 [71.12]	2.400 [60.96]	.585 [14.90] .437 [11.10]	.917 [23.29] .769 [19.53]	104130-9 104315-9
60	3.300 [83.82]	2.900 [73.66]	.585 [14.90] .437 [11.10]	.917 [23.29] .769 [19.53]	1-104130-0 1-104315-0

Low Profile Headers, Shrouded

5

**AMPMODU Stacking Connectors—Shrouded,
.025 x .025 [0.64 x 0.64] Posts**

Product Facts

- Parallel PC board stacking without use of mother boards
- Provides space between boards for interference-free routing of wire-to-board connections
- Two header heights available: .785 [19.94] and 1.200 [30.48]
- Vertical mount headers are fully shrouded
- Receptacle contacts have dual cantilever beams with built-in overstress protection
- .025 [0.64] sq. posts and receptacle contacts on double-row, .100 x .100 [2.54 x 2.54] centers
- Header posts and receptacle contacts are phosphor bronze, duplex plated
- Housings are made of flame retardant, glass-filled

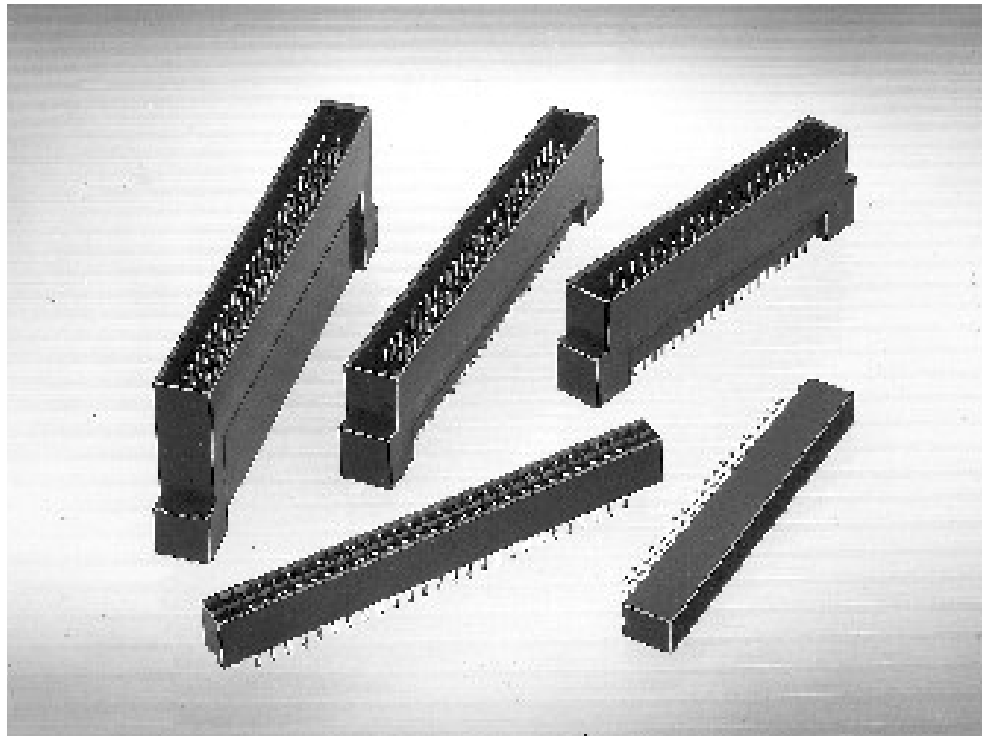

AMPMODU stacking connectors are a two-piece interconnection system designed for parallel stacking printed circuit boards, without the use of mother boards.

Vertical mount headers and receptacle assemblies feature duplex plated posts and receptacle contacts on a double-row, .100 x .100 [2.54 x 2.54] grid. The .025 [0.64] sq. header posts are more protected, and the top-entry receptacle contacts utilize the proven

AMPMODU receptacle contact design; dual cantilever beams with built-in overstress protection.

Headers are available in two heights: .785 [19.94] and 1.200 [30.48]. This allows the customer to use the height of the header to keep wire-to-board connections up and away from other board components, particularly if the components are densely packaged around the header.

Receptacle Assemblies, Double-Row Board Mounted

Vertical Mount, Top Entry, High Profile, Selectively Loaded (with Standoffs)



Material and Finish:

Housing—Brown thermoplastic, flame retardant

Contacts—Phosphor bronze, duplex plated .000015 [0.00038] gold on mating area, .000050-.000100 [0.00127-0.00254] bright tin-lead on solder area, with entire contact underplated .000050 [0.00127] nickel

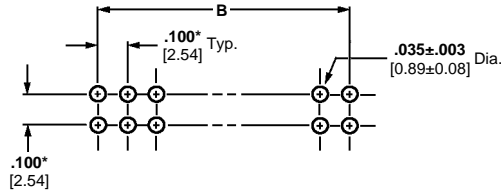
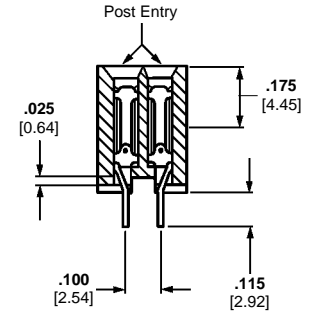
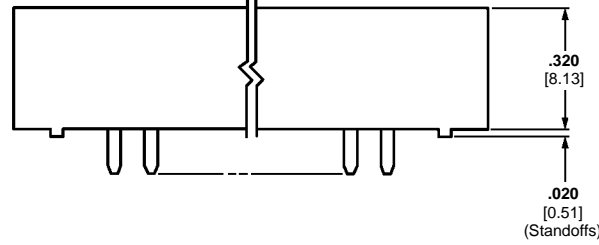
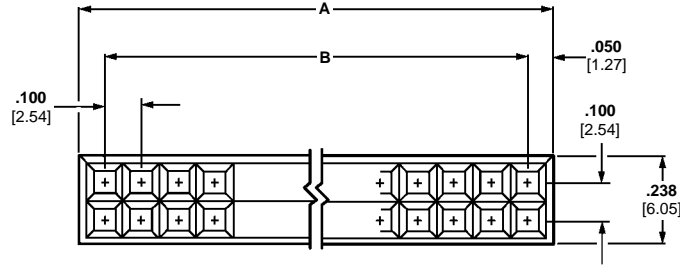

Recommended PC Board Hole Layout

*±.003 [±0.08] tolerances not to accumulate within one connector pattern.

No. of Pos.	Dimensions		Receptacle Assembly Part No.
	A	B	
48* (40 Active)	2.400 [60.96]	2.300 [58.42]	102766-1
60* (52 Active)	3.000 [76.2]	2.900 [73.66]	102766-4

*In addition to the *active* positions, each receptacle has four cavities on each end that are not loaded with contacts. These empty cavities aid in aligning the receptacle with header posts during mating.

- Notes:**
1. AMP, part no. and date code stamped on housing where size permits.
 2. These receptacle assemblies mate with headers of the same size as the *active* positions listed above. Refer to pages 160 and 161.

Headers, Double-Row, .785 [19.94] Height

**.025 x .025 [0.64 x 0.64]
Straight Post (with
Pin Protection)**

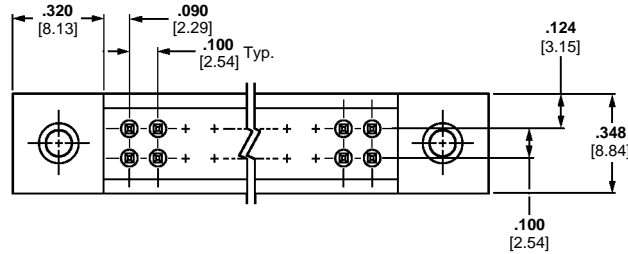

Material and Finish:

Housing—Brown glass-filled thermoplastic, flame retardant

Posts—Phosphor bronze, duplex plated .000015 [0.00038] gold on mating area, .000100-.000200 [0.00254-0.00508] tin-lead on solder area, with entire post underplated .000050 [0.00127] nickel

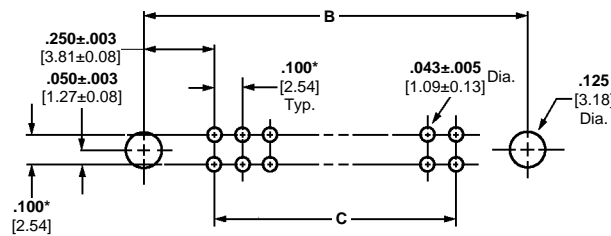
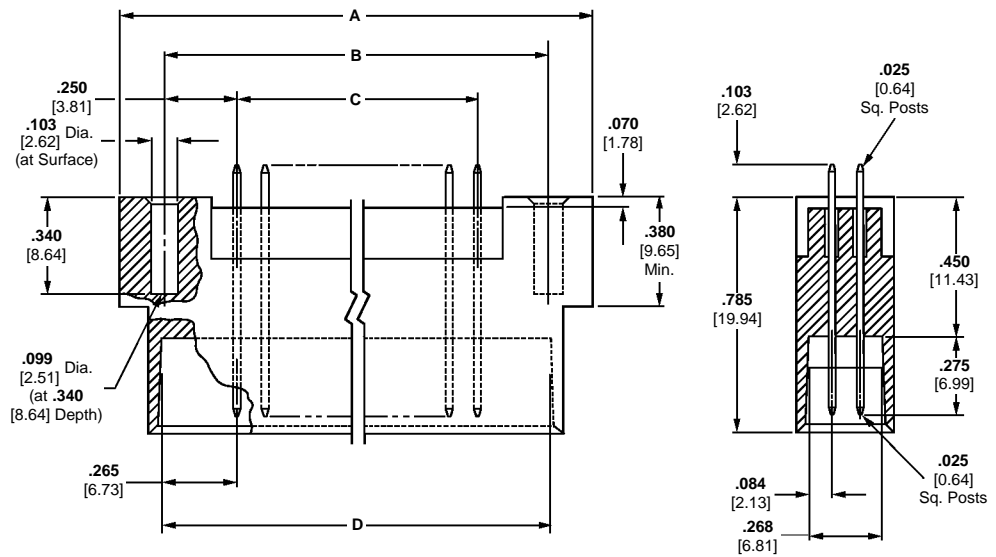

Recommended PC Board Hole Layout

*±.003 [±0.08] tolerances not to accumulate within one connector pattern.

No. of Pos.	Dimensions				Header Part No.
	A	B	C	D	
40	2.720 [69.09]	2.400 [60.96]	1.900 [48.26]	2.430 [61.27]	102871-2
52	3.320 [84.33]	3.000 [76.2]	2.500 [63.5]	3.030 [76.96]	102871-1

Note: These headers mate with receptacle assemblies having the same number of active positions. See page 159.

Headers, Double-Row, 1.200 [30.48] Height

**.025 x .025 [0.64 x 0.64]
Straight Post (with
Pin Protection)**

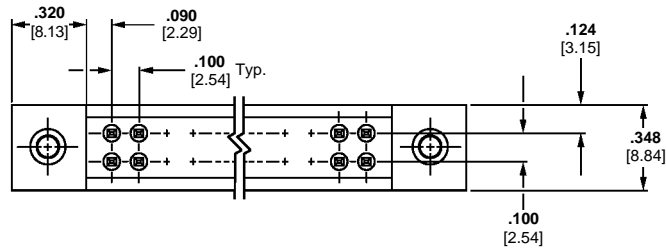

Material and Finish:

Housing—Brown glass-filled thermoplastic, flame retardant

Posts—Phosphor bronze, duplex plated .000015 [0.00038] gold on mating area, .000100-.000200 [0.00254-0.00508] tin-lead on solder area, with entire post underplated .000050 [0.00127] nickel

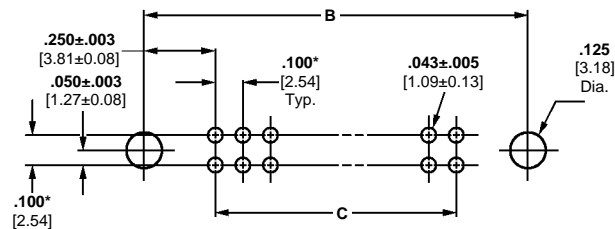
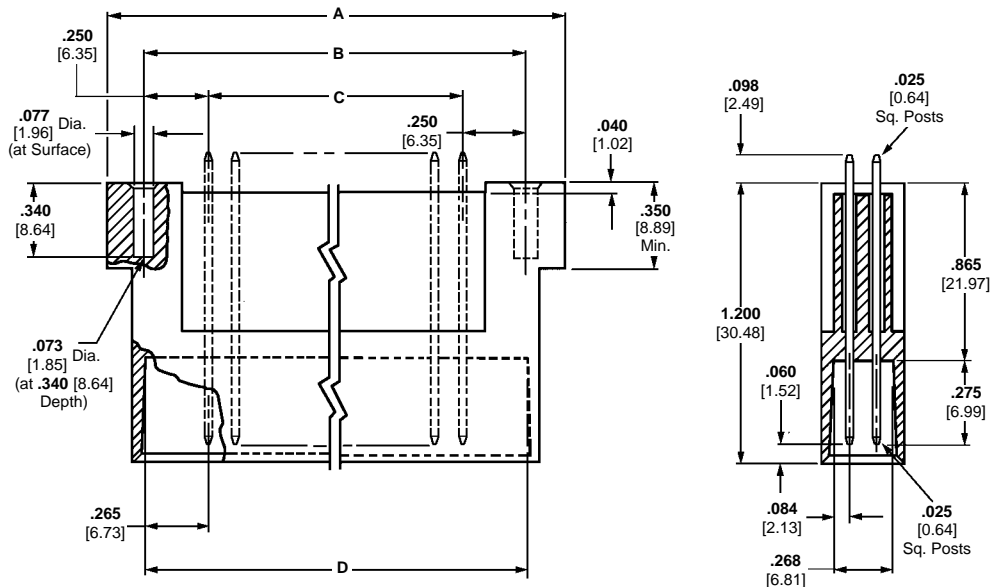

Recommended PC Board Hole Layout

*±.003 [±0.08] tolerances not to accumulate within one connector pattern.

No. of Pos.	Dimensions				Header Part No.
	A	B	C	D	
52	3.320 [84.33]	3.000 [76.2]	2.500 [63.5]	3.030 [76.96]	102826-1

Note: This header mates with receptacle assembly having the same number of active positions. See page 159.

Stranded Stacking Headers

5

ACTION PIN Headers—Shrouded and Unshrouded

Product Facts

- Straight posted unshrouded and shrouded versions
- .025 [0.64] square ACTION PIN posts
- ACTION PIN posts make a gas-tight, press-fit connection in plated-through holes
- Does not damage plated-through holes
- Unshrouded headers available in selected sizes 1 through 40 positions (single-row) and 4 through 80 positions (double-row)
- Shrouded headers (double-row) available in selected sizes of 6 through 60 positions
- Flame retardant, black thermoplastic housings, 94V-0 rated
- Available in .100 [2.54] Centerline spacing in an insulator header that is directly mounted on a printed circuit board
- Recognized under the Component Program of Underwriters Laboratories Inc., File No. E28476
- Certified by Canadian Standards Association, File No. LR 16455

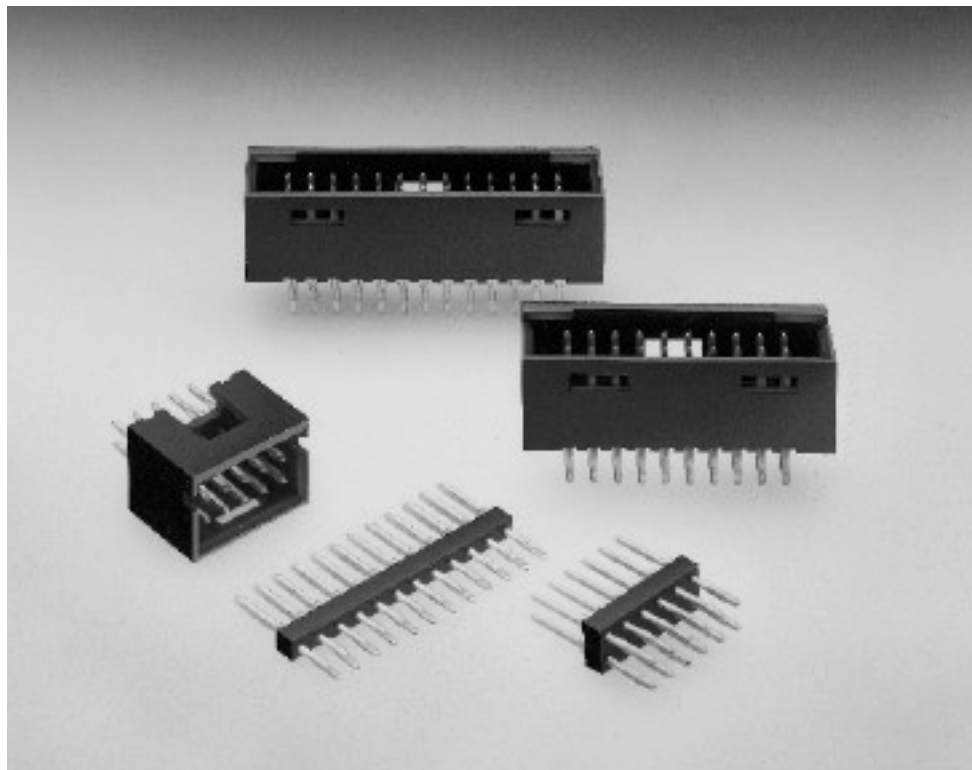

**ACTION PIN Headers—Unshrouded, Single-Row,
.100 [2.54] Centerline**

**.025 [0.64] Square
Straight Post**



Material and Finish:

Housing—Black thermoplastic, 94V-0 rated

Posts—Copper alloy, duplex plated .000030 [0.00076] gold on contact area, .000100-.000200 [0.00254-0.00508] matte tin-lead on termination end, with entire post underplated .000050 [0.00127] nickel

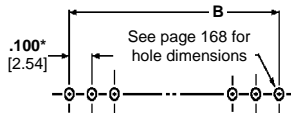
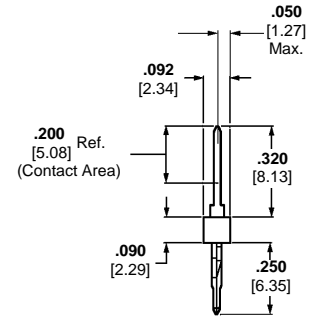
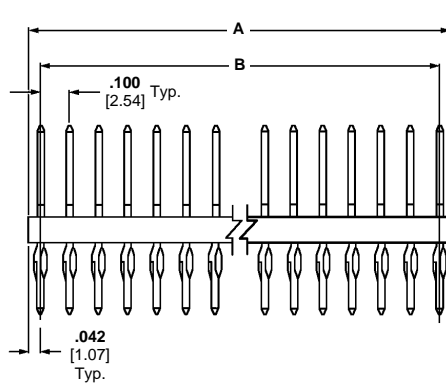

Recommended PC Board Hole Layout
*±.003 [±0.08] tolerances not to accumulate within one connector pattern.

Related Product Data:

Mateable Connectors—Refer to the Mating Post Selection Guide (page 89)

ACTION PIN Posts—pages 167, 168

Application Tooling—page 169

Technical Documents (page 294):

See mating connector for applicable product and application specifications

No. of Pos.	Dimensions		Part Nos.	
	A	B	For .062 [1.57] Thick PC Boards	For .093-.125 [2.36-3.18] Thick PC Boards
1	.084 [2.13]	—	3-103336-5	3-102898-5
2	.184 [4.67]	.100 [2.54]	3-103336-4	3-102898-4
3	.284 [7.21]	.200 [5.08]	4-103336-0	4-102898-0
4	.384 [9.75]	.300 [7.62]	3-103336-6	3-102898-6
5	.484 [12.29]	.400 [10.16]	3-103336-8	3-102898-8
6	.584 [14.83]	.500 [12.70]	3-103336-7	3-102898-7
7	.684 [17.37]	.600 [15.24]	3-103336-9	3-102898-9
8	.784 [19.91]	.700 [17.78]	103336-1	102898-1
9	.884 [22.45]	.800 [20.32]	103336-2	102898-2
10	.984 [24.99]	.900 [22.86]	103336-3	102898-3
11	1.084 [27.53]	1.000 [25.40]	103336-4	102898-4
12	1.184 [30.07]	1.100 [27.94]	103336-5	102898-5
13	1.284 [32.61]	1.200 [30.48]	103336-6	102898-6
14	1.384 [35.15]	1.300 [33.02]	103336-7	102898-7
15	1.484 [37.69]	1.400 [35.56]	103336-8	102898-8
16	1.584 [40.23]	1.500 [38.10]	103336-9	102898-9
17	1.684 [42.77]	1.600 [40.64]	1-103336-0	1-102898-0
18	1.784 [45.31]	1.700 [43.18]	1-103336-1	1-102898-1
19	1.884 [47.85]	1.800 [45.72]	1-103336-2	1-102898-2
20	1.984 [50.39]	1.900 [48.26]	1-103336-3	1-102898-3
21	2.084 [52.93]	2.000 [50.80]	—	1-102898-4
22	2.184 [55.47]	2.100 [53.34]	—	1-102898-5
23	2.284 [58.01]	2.200 [55.88]	—	1-102898-6
24	2.384 [60.55]	2.300 [58.42]	—	1-102898-7
25	2.484 [63.09]	2.400 [60.96]	1-103336-8	1-102898-8
26	2.584 [65.63]	2.500 [63.50]	—	1-102898-9
27	2.684 [68.17]	2.600 [66.04]	—	2-102898-0
28	2.784 [70.71]	2.700 [68.58]	—	2-102898-1
29	2.884 [73.25]	2.800 [71.12]	—	2-102898-2
30	2.984 [75.79]	2.900 [73.66]	2-103336-3	2-102898-3
32	3.184 [80.87]	3.100 [78.74]	2-103336-5	2-102898-5
36	3.584 [91.03]	3.500 [88.90]	2-103336-9	2-102898-9
40	3.984 [101.19]	3.900 [99.06]	3-103336-3	3-102898-3

Note: To insert header into PCboard, use seating tool with arbor tool or air powered machine—page 169.

ACTION PIN Headers—Unshrouded, Double-Row, .100 x .100 [2.54 x 2.54] Centerline

.025 [0.64] Square Straight Post



Material and Finish:

Housing—Black thermoplastic, 94V-0 rated

Posts—Copper alloy, duplex plated .000030 [0.00076] gold on contact area, .000100-.000200 [0.00254-0.00508] matte tin-lead on termination end, with entire post underplated .000050 [0.00127] nickel

Related Product Data:

Mateable Connectors—Refer to the Mating Post Selection Guide (page 89)

ACTION PIN Posts—pages 167, 168

Application Tooling—page 169

Accessories:

Barrier Insert—page 221

Technical Documents (page 294):

See mating connector for applicable product and application specifications

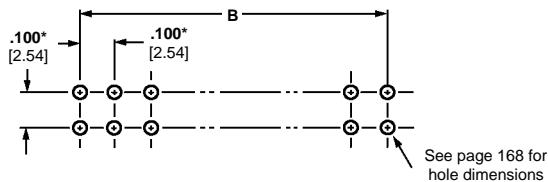
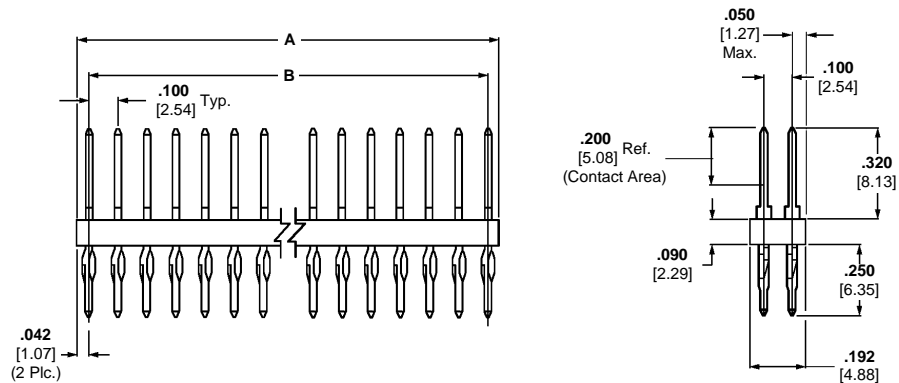

Recommended PC Board Hole Layout

*±.003 [±0.08] tolerances not to accumulate within one connector pattern.

No. of Pos.	Dimensions		Part Nos.	
	A	B	For .062 [1.57] Thick PC Boards	For .093-.125 [2.36-3.18] Thick PC Boards
4	.184 [4.67]	.100 [2.54]	103542-1	103233-1
6	.284 [7.21]	.200 [5.08]	103542-2	103233-2
8	.384 [9.75]	.300 [7.62]	103542-3	103233-3
10	.484 [12.29]	.400 [10.16]	103542-4	103233-4
12	.584 [14.83]	.500 [12.70]	103542-5	103233-5
14	.684 [17.37]	.600 [15.24]	103542-6	103233-6
16	.784 [19.91]	.700 [17.78]	103542-7	103233-7
18	.884 [22.45]	.800 [20.32]	103542-8	103233-8
20	.984 [24.99]	.900 [22.86]	103542-9	103233-9
22	1.084 [27.53]	1.000 [25.40]	1-103542-0	1-103233-0
24	1.184 [30.07]	1.100 [27.94]	1-103542-1	1-103233-1
26	1.284 [32.61]	1.200 [30.48]	1-103542-2	1-103233-2
28	1.384 [35.15]	1.300 [33.02]	1-103542-3	1-103233-3
30	1.484 [37.69]	1.400 [35.56]	1-103542-4	1-103233-4
32	1.584 [40.23]	1.500 [38.10]	1-103542-5	1-103233-5
34	1.684 [42.77]	1.600 [40.64]	1-103542-6	1-103233-6
36	1.784 [45.31]	1.700 [43.18]	1-103542-7	1-103233-7
38	1.884 [47.85]	1.800 [45.72]	1-103542-8	1-103233-8
40	1.984 [50.39]	1.900 [48.26]	1-103542-9	1-103233-9
42	2.084 [52.93]	2.000 [50.80]	2-103542-0	2-103233-0
46	2.284 [58.01]	2.200 [55.88]	2-103542-2	—
50	2.484 [63.09]	2.400 [60.96]	2-103542-4	2-103233-4
60	2.984 [75.79]	2.900 [73.66]	2-103542-9	2-103233-9
66	3.284 [83.41]	3.200 [81.28]	3-103542-2	—
80	3.984 [101.19]	3.900 [99.06]	3-103542-9	3-103233-9

ACTION PIN Headers, Unshrouded

5

ACTION PIN Headers—Shrouded with .066 [1.68] End Dimension, Double-Row, .100 x .100 [2.54 x 2.54] Centerline

.025 [0.64] Square Straight Post (with Detent Windows, for .093-.125 [.236-3.18] Thick PC Board)



Material and Finish:

Housing—Black thermoplastic, 94V-0 rated

Posts—Copper alloy, duplex plated .000030 [0.00076] gold on contact area, .000100-.000200 [0.00254-0.00508] matte tin-lead on termination end, with entire post underplated .000050 [0.00127] nickel

Related Product Data:

Mateable Connectors:

AMPMODU Board Mount Receptacles—pages 193, 196, 197

AMPMODU Wire-Applied Receptacles—pages 234-236

AMPMODU MT Receptacles—pages 275, 276

ACTION PIN Posts—pages 167, 168

Application Tooling—page 169

Accessories:

Barrier Insert—page 221

Technical Documents (page 294):

See mating connector for applicable product and application specifications

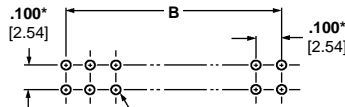
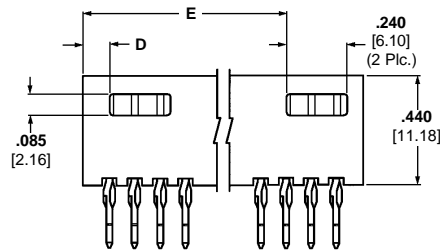
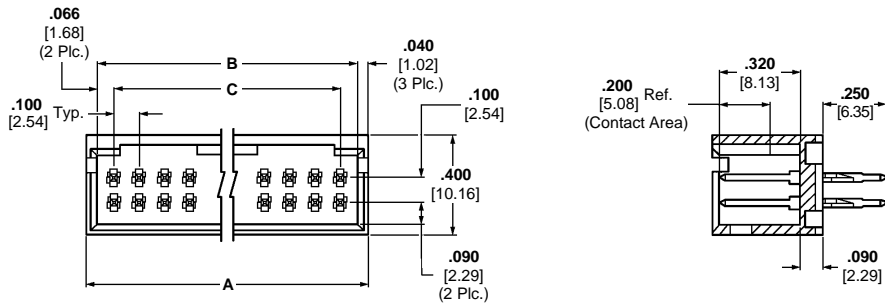

See page 168 for hole dimensions

Recommended PC Board Hole Layout

*±.003 [±0.08] tolerances not to accumulate within one connector pattern.

No. of Pos.	Dimensions					Header Part Nos.
	A	B	C	D	E	
6	.412 [10.46]	.332 [8.43]	.200 [5.08]	.106 [2.69]	—	102699-2
8	.512 [13.00]	.432 [10.97]	.300 [7.62]	.106 [2.69]	—	102699-3
10	.612 [15.54]	.532 [13.51]	.400 [10.16]	.206 [5.23]	—	102699-4
12	.712 [18.08]	.632 [16.05]	.500 [12.70]	.206 [5.23]	—	102699-5
14	.812 [20.62]	.732 [18.59]	.600 [15.24]	.306 [7.77]	—	102699-6
16	.912 [23.16]	.832 [21.13]	.700 [17.78]	.306 [7.77]	—	102699-7
18	1.012 [25.70]	.932 [23.67]	.800 [20.32]	.406 [10.31]	—	102699-8
20	1.112 [28.24]	1.032 [26.21]	.900 [22.86]	.106 [2.69]	.806 [20.47]	102699-9
26	1.412 [35.86]	1.332 [33.83]	1.200 [30.48]	.106 [2.69]	1.106 [28.09]	1-102699-2
30	1.612 [40.94]	1.532 [38.91]	1.400 [35.56]	.106 [2.69]	1.306 [33.17]	1-102699-4
34	1.812 [46.02]	1.732 [43.99]	1.600 [40.64]	.106 [2.69]	1.506 [38.25]	1-102699-6
40	2.112 [53.64]	2.032 [51.61]	1.900 [48.26]	.106 [2.69]	1.806 [45.87]	1-102699-9
50	2.612 [66.34]	2.532 [64.31]	2.400 [60.96]	.106 [2.69]	2.306 [58.57]	2-102699-3
60	3.112 [79.04]	3.032 [77.01]	2.900 [73.66]	.106 [2.69]	2.806 [71.27]	2-102699-8

ACTION PIN Headers, Shrouded

5

ACTION PIN Headers—Shrouded with .150 [3.81] End Dimension, Double-Row, .100 x .100 [2.54 x 2.54] Centerline

.025 [0.64] Square Straight Post (with Detent Windows, for .093-.125 [.236-3.18] Thick PC Board)



Material and Finish:

Housing—Black thermoplastic, 94V-0 rated

Posts—Copper alloy, duplex plated .000030 [0.00076] gold on contact area, .000100-.000200 [0.00254-0.00508] matte tin-lead on termination end, with entire post underplated .000050 [0.00127] nickel

Related Product Data:

Mateable Connectors:

AMPMODU MTE Receptacles—pages 249,250

Flexible Film Connectors—Catalog 82007

ACTION PIN Posts—pages 167, 168

Application Tooling—page 169

Accessories:

Barrier Insert—Page 221

Technical Documents (page 294):

See mating connector for applicable product and application specifications

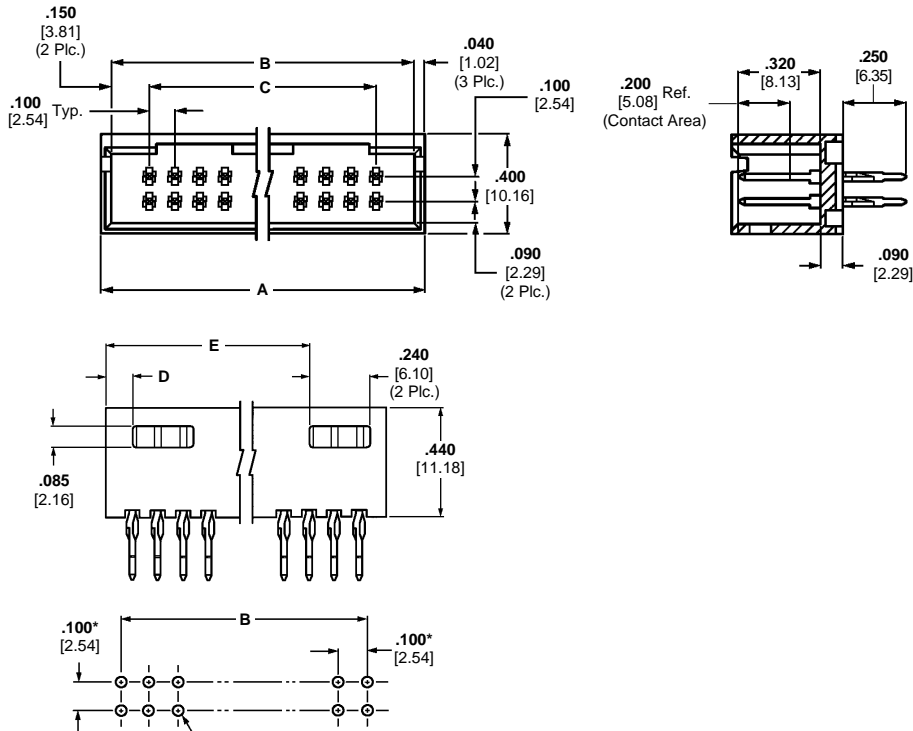

Recommended PC Board Hole Layout

*±.003 [±0.08] tolerances not to accumulate within one connector pattern.

No. of Pos.	Dimensions					Header Part Nos.
	A	B	C	D	E	
6	.580 [14.73]	.500 [8.43]	.200 [5.08]	.190 [4.83]	—	1-102557-0
8	.680 [17.27]	.600 [10.97]	.300 [7.62]	.190 [4.83]	—	1-102557-1
10	.780 [19.81]	.700 [17.78]	.400 [10.16]	.290 [7.37]	—	102557-9
12	.880 [22.35]	.800 [20.32]	.500 [12.70]	.290 [7.37]	—	1-102557-2
14	.980 [24.89]	.900 [22.86]	.600 [15.24]	.390 [9.91]	—	1-102557-3
16	1.080 [27.43]	1.000 [25.40]	.700 [17.78]	.390 [9.91]	—	1-102557-4
18	1.180 [29.97]	1.100 [27.94]	.800 [20.32]	.490 [10.31]	—	1-102557-5
20	1.280 [32.51]	1.200 [30.48]	.900 [22.86]	.190 [4.83]	.890 [22.61]	102557-2
24	1.480 [37.59]	1.400 [35.56]	1.100 [27.94]	.190 [4.83]	1.090 [27.69]	1-102557-7
26	1.580 [40.13]	1.500 [38.10]	1.200 [30.48]	.190 [4.83]	1.190 [30.23]	102557-3
30	1.780 [45.21]	1.700 [43.18]	1.400 [35.56]	.190 [4.83]	1.390 [35.31]	102557-4
34	1.980 [50.29]	1.900 [48.26]	1.600 [40.64]	.190 [4.83]	1.590 [40.39]	102557-5
40	2.280 [57.91]	2.200 [55.88]	1.900 [48.26]	.190 [4.83]	1.890 [48.01]	102557-1
50	2.780 [70.61]	2.700 [68.58]	2.400 [60.96]	.190 [4.83]	2.390 [60.71]	102557-6
60	3.280 [83.31]	3.200 [81.28]	2.900 [73.66]	.190 [4.83]	2.890 [73.41]	102557-7

ACTION PIN Headers, Shrouded

5

AMP ACTION PIN Press-Fit Posts

The Reliable Plated-Through Hole Interconnect

Solderless interconnections have been popular in electrical and electronic applications with world-wide success for decades. They provide reliable electrical and mechanical stability and offer applied-cost savings across the board. For PC board applications, AMP compliant ACTION PIN posts provide these features:

- Large gas-tight contact zone
- High reliability due to stored energy
- More resistant to damage to plated-through holes during installation
- Especially suited for multilayer PC boards
- Less costly board manufacturing due to larger hole tolerances compared to use of solid pins
- Application can be made by end-user
- Repairability—contact can be replaced in the same pin location (two repairs)
- Installation with no heat cycling of board
- Permits mass insertion by minimizing forces needed to insert pins as compared to solid pin press-fit application
- Significant applied-cost savings in many applications

Since AMP compliant ACTION PIN posts do not have to be soldered, problems associated with solder are eliminated, such as:

- Faulty solder joints
- Solder fumes; contaminants are deposited on the contacts
- Solder spots; short circuits between printed circuits
- Flux residuals
- Thermal strain on printed circuit boards and components
- Degasing of plated-through holes

Solderless press-fit interconnections using AMP compliant pins are primarily integrated in, but not limited to, backplanes.

Solderless press-fit interconnections are used in racks, especially where connectors must be fixed on the solder side of the PC board and/or component side. In these applications, the holes for AMP ACTION PIN post connectors are covered during the soldering process and press-fitting is performed after soldering.

Other applications for AMP ACTION PIN post interconnections include PC boards that incorporate components using surface mount technology (SMT). Here, too, press-fit interconnections can be applied after soldering, thus eliminating complications associated with connectors suitable for surface mounting.

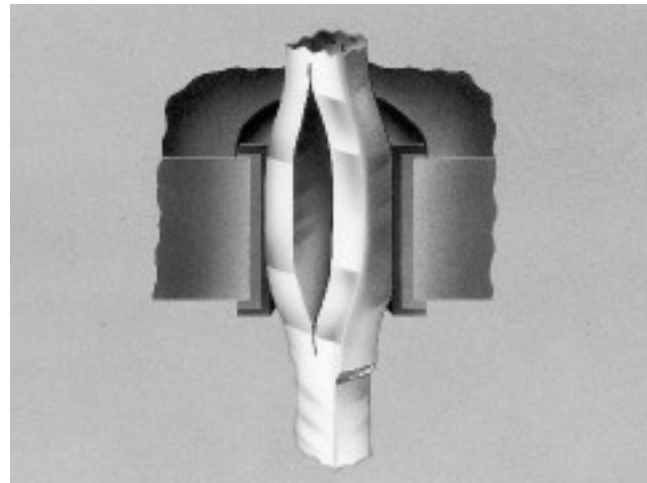

Principle of the AMP Compliant ACTION PIN Post

When an AMP compliant ACTION PIN post is inserted into a plated-through hole, two spring members are compressed, exerting force against the hole for a gas-tight connection. The diameter of the hole is smaller than the diagonal size of the pin (see cross-section illustration below).

The beam characteristics of the pin are designed so that a plastic, as well as an elastic, deformation takes place during insertion. The two spring members compress to different degrees to accommodate hole tolerances. The compliant pin also reduces strain on the board. With a rigid pin, the elastic strain energy is stored entirely in the board, leading to damage of the plated-through holes. With the AMP compliant ACTION PIN post, the residual force of the elastic deformation maintains stored energy to produce a tight contact zone between the pin and the plated-through hole. This maintains long-term electrical and mechanical reliability of the interconnection.

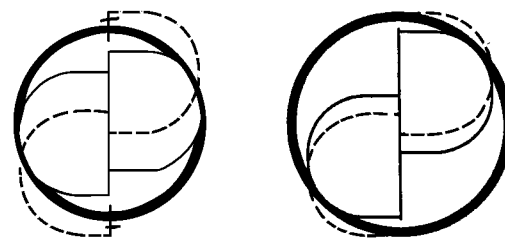

Minimum Hole Dia. .037 [0.94]

Maximum Hole Dia. .043 [1.09]

Cross-Section Area of AMP ACTION PIN Press-Fit Post in Printed Circuit Board Holes

AMP ACTION PIN Press-Fit Posts (Continued)



ACTION PIN posts provide a more reliable press-fit connection. Localized pressure in the interface area for oxide break-through and prevents corrosion better in many of the harshest environments to provide a reliable connection virtually every time. Also, radial and axial distortion are controlled to meet today's standards for multilayer board applications.

PC Board Thickness

ACTION PIN posts designed for use in a variety of PC board thicknesses. However, certain ACTION PIN posts are to be used in specific ranges of board thicknesses. To promote optimum performance, the recommended board thicknesses provided with the connector being used must be followed.

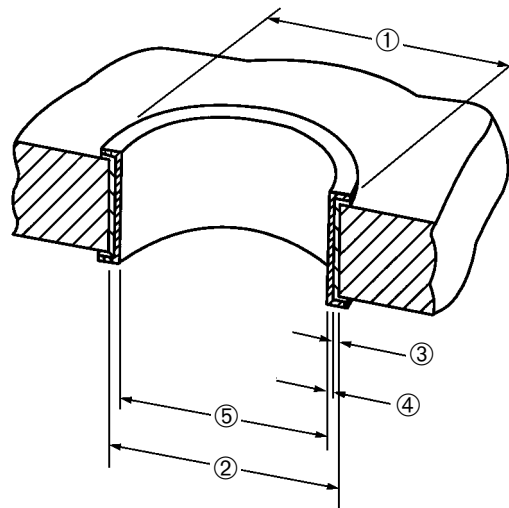

- ① Annular Ring (See Note)
- ② Drilled Hole
- ③ Copper Thickness
- ④ Tin-Lead Thickness
- ⑤ Plated-Through Hole

ACTION PIN Post/PC Board Applications

ACTION PIN Contact Material Thickness	Drilled Hole Diameter ^②	Plating Thicknesses		Plated-Through Hole Diameter ^⑤	Distortion Specification*	
		Copper ^{③*}	Tin-Lead ^④		Average	Maximum
.025 [0.64]	.0453 ^{±.001} [1.151 ^{±0.03}]	.001-.003 [0.03-0.08]	.0003 [0.008]Min.	.037-.043 [0.94-1.09]	.0015 [0.038]	.002 [0.05]

*Maximum hardness of copper layer is 150 Knoop.

**Radial hole distortion.

Note: Recommended annular ring diameter is hole diameter plus .020 [0.51].

Application Tooling for AMPMODU Headers with ACTION PIN Posts

ACTION PIN Post Replacement Tooling



Rear Insertion/Extraction Tool
 No. 265871-7 (Ref. 408-2636)
Includes:
 Impact Tool No. 380392-8
 Removal Tool No. 265964-1
 Replacement Tip No. 308554-1

Single-Row Connector Seating Tools

Tooling Assembly No. 91171-1 is used to install single-row AMPMODU headers with ACTION PIN posts into PC boards.

Pin headers with ACTION PIN posts allow high speed, solderless back-plane construction through reliable press-fit application. Press fitting connectors to printed circuit boards requires special seating tools which transfer application force directly to the contacts.

Force applied to the tool to seat the connectors can be provided by the AMP seating machines shown on this page.

Double-Row Connector Seating Tools

Header Size (No. of Pos.)	Tool Assembly No.
4	91170-1
6	91170-1
8	91170-2
12	91170-5
14	91170-6
16	91170-7
20	91170-9
24	1-91170-1
30	1-91170-4
36	1-91170-7
40	1-91170-9
50	2-91170-4
60	2-91170-9
80	3-91170-2
96	3-91170-5
100	3-91170-6
120	3-91170-8
140	4-91170-0
200	4-91170-2

Triple-Row Connector Seating Tools

Header Size (No. of Pos.)	Tool Assembly No.
96	91169-8
105	91169-6
120	91169-7
150	91169-3
195	91169-2
204	91169-1
210	91169-5
300	91169-9

For tooling information, call the Tyco Electronics Automation Group 1-215-657-6202.

ASG Servo Electric Presses

Tyco Electronics offers a wide range of servo-electric presses for the application of press-fit connectors. Systems are available with varying force capacity, board size capacity and process capability. Each system features real-time force feedback and PC control to allow the highest level of control and traceability. Every

connector pressed is monitored to assure that maximum force is not exceeded and minimum force is met. Each system controls force, height and speed to allow termination of the pressing cycle by force or height parameters. Complete SPC data is available as each connector press cycle is monitored and stored. ASG presses

are available in both semi-automatic and fully automatic inline systems.

Please see the matrix below and contact Tyco Electronics Automation Group at 1-215-657-6202 for assistance in understanding which system will best meet your needs.



BMEP-5T



AP3

Press Model	Description	Tyco Electronics Part Number	Max Pressing Force tons [kN]	Max Board Size (L x W) in [mm]
BMEP 3T	Semi-automatic, benchtop servo-electric press	1585697-1	3 [26.7]	18 x 24 [460 x 610]
BMEP 5T	Semi-automatic, benchtop servo-electric press	1585696-1	5 [44.5]	18 x 24 [460 x 610]
MEP 6T	Semi-automatic, stand-alone servo-electric press	1585699-1	6 [53.4]	24 x 36 [610 x 914]
MEP 12T	Semi-automatic, stand-alone servo-electric press	1585698-1	12 [106.8]	30 x 36 [762 x 914]
AEP 12T	Automatic servo-electric press	1-1399600-7	12 [106.8]	36 x 48 [914 x 1219]
AP3	Fully automatic pick, place and press	1585280-1	8 [71.2]	18 x 30 [457 x 762]

Application Tooling for Post Insertion

Comp-U-Sertor II Insertion Machine No. 122300-1

This machine has a compact, microprocessor-controlled X-Y positioning table for inserting a variety of AMP posts, sockets and receptacles at rates up to 14,000 contacts per hour. It is programmed and operated with an easy-to-use, menu-driven touchscreen. Programs are stored in a battery-backed Random Access Memory. A 3.5" floppy disk drive is provided for off-line programming and storage. Insertion heads are interchangeable. The insertable area is 12 x 18 [305 x 457]. The power requirement is 120 VAC, 50-60 Hz, 7 A; the air requirement is 90 psi [6.21 bar] at 2-15 scfm [0.00094-0.00708 m³/s], depending upon application.

For further information, request Tyco Electronics Customer Manual 409-5863.



Photo 96187-1

Modular Insertion System Bench Machine No. 217600-1

This machine uses AMP insertion heads to install a variety of printed circuit board products at rates of 2,000 per hour. The printed circuit board is placed in a Board Holding Fixture which is attached to a two-hand controlled mechanism. The operator moves the board over the machine anvil; a switch in the anvil actuates the machine when the printed circuit board is placed on the anvil. A spotlight illuminates the insertion area.

Consult Tyco Electronics for further information on this machine and the insertion heads.



Photo 98731



P300 Automatic Insertion Machine

The P300 is a fully automatic insertion machine for processing reeled press-fit and thru-hole components into PCBs. It is available as either a stand-alone unit or as an inline system. Boards up to 15.5" x 23.5" [400 x 600] can be processed and are positioned by an X/Y table. Each contact is seated in the PCB via a product specific insertion head. An optional automatic tool changer system allows up to 3 different insertion heads to be used. A multi-tasking control unit controls and monitors the entire system. Optional insertion force monitoring allows the verification of every component applied for quality assurance. A wide range of optional equipment is available for further performance and flexibility enhancement.

Please consult Tyco Electronics for further information on this machine.

**AMP ACTION PIN Stacking Connector System
(Non-Intermateable with AMPMODU Connectors)**

Product Facts

- Can stack multiple printed circuit boards without the need of a mother board
- Connect bus lines in the shortest possible distance
- Receptacle assembly has ACTION PIN posts for solderless board mounting
- Can be mounted onto the board simply by press fitting with Mini-Press
- Receptacle assembly is easy to service and replace (up to 2 times)
- Receptacle contacts are of fork design to mate with posts at two points. No danger of scooping at mating/ unmating
- Stacking dimensions are 13.4 [.528] or 19.0 [.748] when using receptacle assemblies together, and 13.9 [.547] or 19.5 [.768] when using a combination of receptacle and post header assemblies
- Accepts 1.6 [.062] thick boards
- Housing provided with polarization to help prevent mismatching
- Housing made of chemical-resistant glass-filled PBT, black in color
- Contacts are of copper alloy material with high spring characteristics, gold-over-nickel plated
- Post hood available to protect the post portion of receptacle contacts. Can be selected depending on stacking dimensions
- Connectors available in sizes of 26, 30, 34, 40, 50 and 60 positions
- Product specification: 108-5197

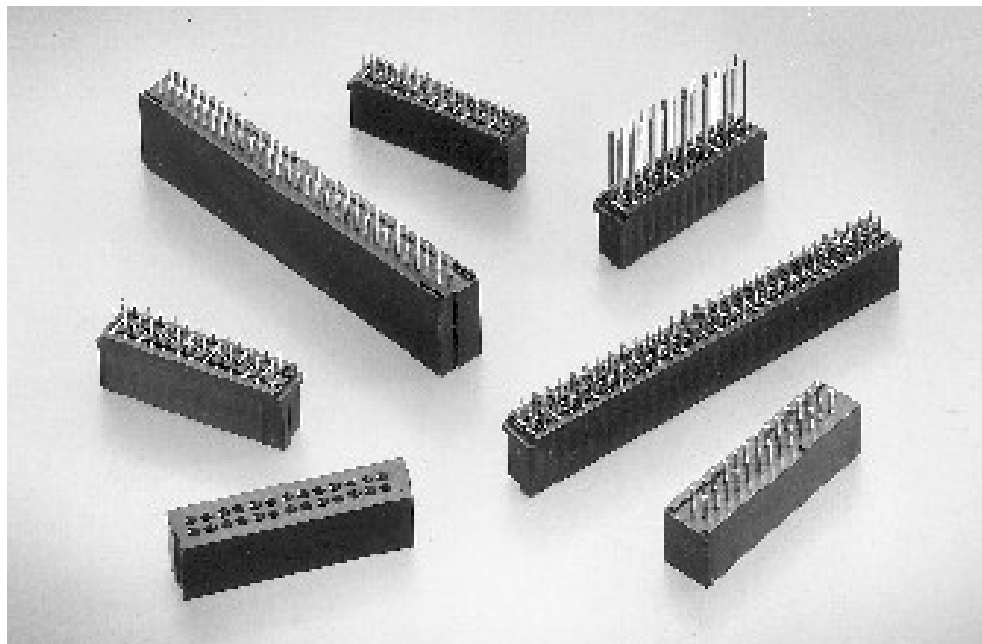

AMP ACTION PIN Stacking Connectors are a family of two-piece connectors used to stack multiple printed circuit boards in parallel. They have been developed to provide a more reliable and economical means of compact wiring and high-density packaging inside a variety of electronic equipment.

The connectors have many advanced features: they can be used to connect

bus lines in the shortest possible distance without the need of a mother board, thus permitting effective utilization of space above the board; compared with other methods of jumper connection using cable connectors, they make the overall board layout more clean and straight for compact packaging.

Contacts are on 2.54 x 2.54 [.100 x .100] grid. The connectors are available in

sizes of 26, 30, 34, 40, 50 and 60 positions. AMP ACTION PIN Stacking Connectors consist of a receptacle assembly, a mating post header and a post hood to protect the post portion of the receptacle assembly.

A complete description of the AMP ACTION PIN Stacking Connectors is presented on the following page (172).

**AMP ACTION PIN Stacking Connector System
(Non-Intermateable with AMPMODU Connectors)** (Continued)

Receptacle Assembly

The receptacle assembly features reliability and economy characteristic of this product line.

The mating portion of its built-in receptacle contacts is of a fork design, highly resilient and help prevents damage to contacts by scooping at mating/unmating.

On the board mount side of the assembly are 0.55 [.022] square ACTION PIN posts.

No soldering is required to mount the assembly on the board, the posts being simply, press fit into the board's 0.825 [.032] diameter holes.

Two types of receptacle assembly are available; one is used with an outermost

board and the other with intermediary boards. A solder version is also available for the outer board mount assembly.

Post Hood

When using the intermediary board mount receptacle assembly, this post hood is used to protect the post portion of the assembly. The post hood is available in two types: one with the housing height of 10.0 [.394] and the other with the housing height of 15.7 [.618]. They can be selected, depending on stacking dimensions.

Post Header

The post header is mounted onto the outer board on the other side of the board to

which an outer board mount receptacle assembly is applied. The post header is preloaded with 0.50 [.022] square soldering posts. These posts are protected by the side walls of the housing.

Stacking dimensions provided by this connector line are as follows:

When the outer board receptacle and intermediary board receptacle assemblies are used 13.4 [.528] or 19.0 [.748].

When the intermediary board receptacle assembly and the post header assembly are used 13.9 [.547] or 19.5 [.768].

Typical Application

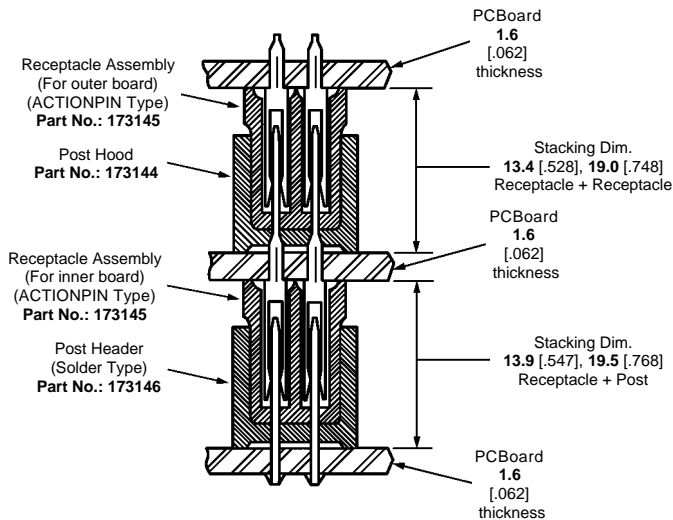



The post hood, mounted onto the post of the intermediary receptacle assembly, protects the post and serves as a header assembly when stacking several boards.

Material:

Black glass-filled PBT, 94V-0 rated

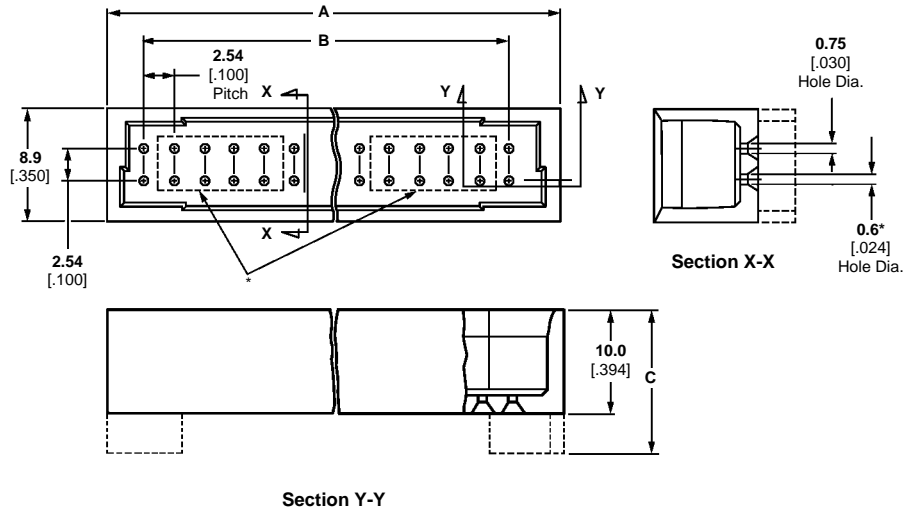

Acceptable Post Length	No. of Pos.	Dimensions (See Note.)			Post Hood Part Nos.
		A	B	C	
For 8.9 [.350] or 10.9 [.429] (For Stacking Dimension) 13.4 [.528]	26	38.1 [1.500]	30.48 [1.200]	10.0 [.394]	1-173144-1
	30	43.2 [1.700]	33.56 [1.321]	10.0 [.394]	173144-2
	34	48.3 [1.900]	40.64 [1.600]	10.0 [.394]	1-173144-2
	40	55.9 [2.200]	48.26 [1.900]	10.0 [.394]	173144-3
	50	68.6 [2.700]	65.96 [2.597]	10.0 [.394]	173144-4
For 14.5 [.571] or 16.5 [.650] (For Stacking Dimension) 19.0 [.748]	60	81.3 [3.200]	73.66 [2.900]	10.0 [.394]	173144-5
	26	38.1 [1.500]	30.48 [1.200]	15.6 [.614]	1-173144-3
	30	43.2 [1.700]	33.56 [1.321]	15.6 [.614]	173144-7
	34	48.3 [1.900]	40.64 [1.600]	15.6 [.614]	1-173144-4
	40	55.9 [2.200]	48.26 [1.900]	15.6 [.614]	173144-8
	50	68.6 [2.700]	65.96 [2.597]	15.6 [.614]	3-173144-8*
60	81.3 [3.200]	73.66 [2.900]	15.6 [.614]	173144-9	
60	81.3 [3.200]	73.66 [2.900]	15.6 [.614]	1-173144-0	

*0.60 [.024] dia. applies to 16 holes on both sides, except Part No. 3-173144-8.

Stacking Connectors, Post Hood

5

**Receptacle Assemblies with ACTION PIN Posts and Solder Posts
(Non-Intermateable with AMPMODU Connectors)**

**Receptacle Assembly for
Outer Board (With 0.55
[.022] Square Post)**



Material and Finish:

Housing—Black glass-filled PBT, 94V-0 rated

Contacts—Copper alloy, plated 0.00020 [0.00008] gold on contact area and post mating area, gold flash on ACTION PIN tail or 0.00100-0.00254 [0.00040-.000100] tin-lead on solder tail, with entire contact underplated 0.00130 [0.000050] nickel

Application Tooling shown on page 179.

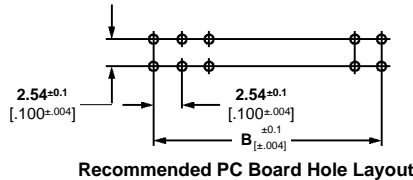
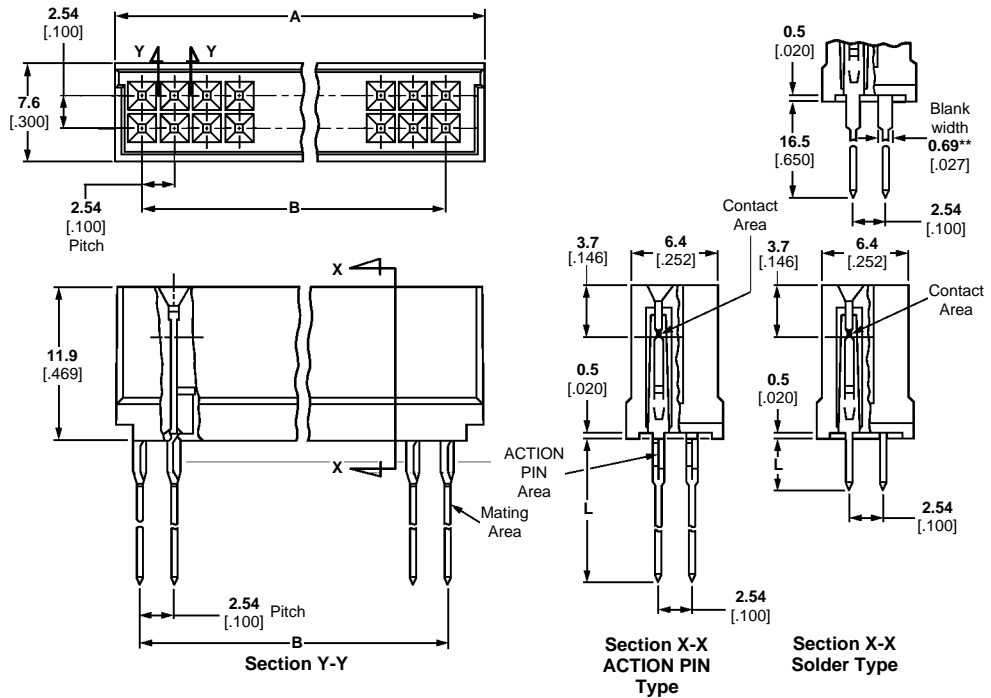

PC Board Mounting Dimensions

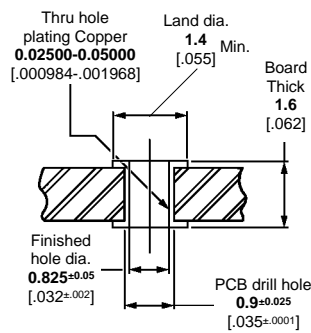

ACTION PIN Post

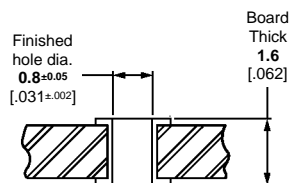

Solder Post

For Outer Board

Type	Post Length L	No. of Pos.	Dimensions (See Note.)		Receptacle Assembly Part Nos.
			A	B	
ACTIONPIN Post	4.2*	26	35.6 [1.402]	30.48 [1.200]	1-173145-7
		30	40.6 [1.598]	35.56 [1.400]	173145-2
		34	45.7 [1.799]	40.64 [1.600]	1-173145-8
		40	53.3 [2.098]	48.26 [1.900]	173145-3
		50	66.0 [2.598]	60.96 [2.400]	173145-4
		60	78.7 [3.098]	73.66 [2.900]	173145-5
Solder Post	4.2*	26	35.6 [1.402]	30.48 [1.200]	2-173145-8
		30	40.6 [1.598]	35.56 [1.400]	2-173145-4
		34	45.7 [1.799]	40.64 [1.600]	2-173145-9
		40	53.3 [2.098]	48.26 [1.900]	2-173145-5
		50	66.0 [2.598]	60.96 [2.400]	2-173145-6
		60	78.7 [3.098]	73.66 [2.900]	2-173145-7 3-173145-0**

*After mounted receptacle assembly is on board, dimension of extrude length from board is 2.6 [0.102].
**Post Length = 17.0 [0.669], Blank Width = 0.69 [0.027] (see above figure) (finished hole dia. = 1.0 [0.039]).

**Receptacle Assemblies with ACTION PIN Posts
(Non-Intermateable with AMPMODU Connectors)**

Receptacle Assembly for Inner Board (With 0.55 [.022] Square Post)

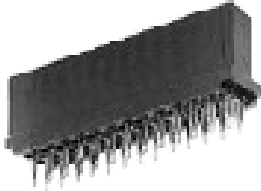

Material and Finish:

Housing—Black glass-filled PBT, 94V-0 rated
Contacts—Copper alloy, plated 0.00020 [.000008] gold on contact area and post mating area, gold flash on ACTION PIN tail or 0.00100-0.00254 [.000040-0.000100] tin-lead on solder tail, with entire contact underplated 0.00130 [.000050] nickel

Application Tooling shown on page 179.

PC Board Mounting Dimensions

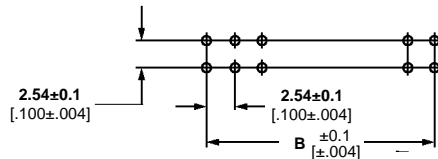
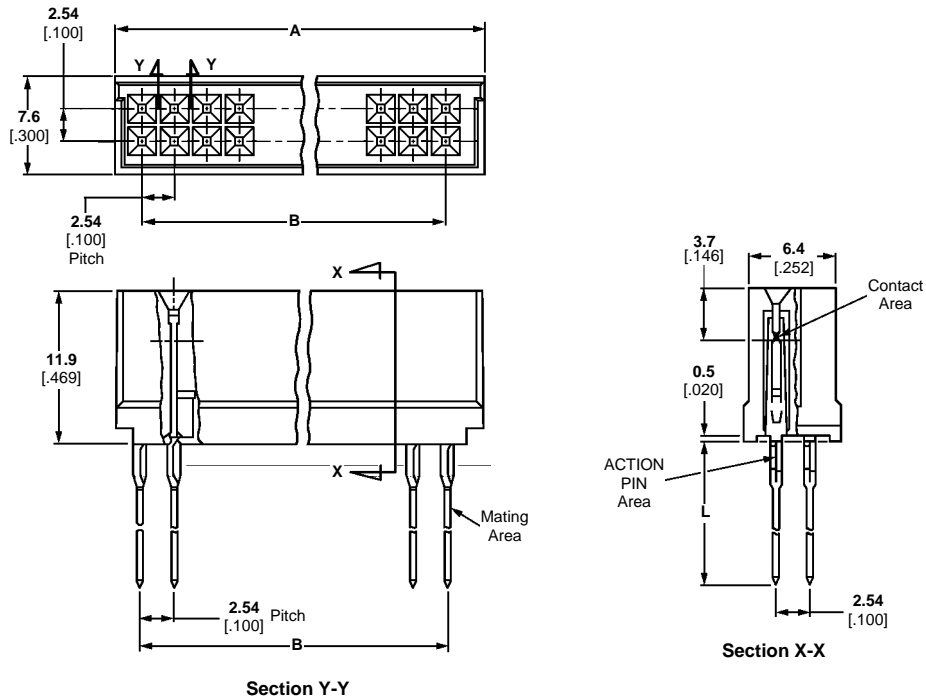
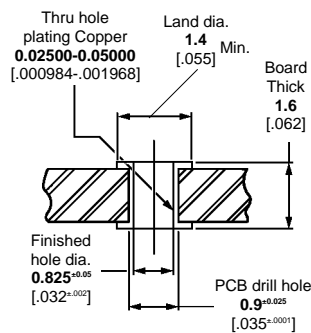

For Inner Board

Stacking Dimensions	Post Length L	No. of Pos.	Dimensions (See Note.)		Receptacle Assembly Part Nos.
			A	B	
13.4 [.528]	8.9 .350	26	35.6 [1.402]	30.48 [1.200]	3-173145-6
		30	40.6 [1.598]	35.56 [1.400]	3-173145-2
		34	45.7 [1.799]	40.64 [1.600]	3-173145-7
		40	53.3 [2.098]	48.26 [1.900]	3-173145-3 3-173145-1**
		50	66.0 [2.598]	60.96 [2.400]	3-173145-4
		60	78.7 [3.098]	73.66 [2.900]	3-173145-5
	10.9 .429	26	35.6 [1.402]	30.48 [1.200]	1-173145-9
		30	40.6 [1.598]	35.56 [1.400]	173145-7
		34	45.7 [1.799]	40.64 [1.600]	2-173145-0
		40	53.3 [2.098]	48.26 [1.900]	173145-8
		50	66.0 [2.598]	60.96 [2.400]	173145-9
		60	78.7 [3.098]	73.66 [2.900]	1-173145-0

**Contact area and post mating area: 0.00050 [.000020] min. gold over 0.00130 [.000050] min. nickel plated.

**Receptacle Assemblies with ACTION PIN Posts
(Non-Intermateable with AMPMODU Connectors)** (Continued)

For Inner Board

Stacking Dimensions	Post Length L	No. of Pos.	Dimensions (See Note.)		Receptacle Assembly Part Nos.
			A	B	
19.0 [.748]	14.5 [.571]	26	35.6 [1.402]	30.48 [1.200]	4-173145-2
		30	40.6 [1.598]	35.56 [1.400]	3-173145-8
		34	45.7 [1.799]	40.64 [1.600]	4-173145-3
		40	53.3 [2.098]	48.26 [1.900]	3-173145-9
		50	66.0 [2.598]	60.96 [2.400]	4-173145-0
		60	78.7 [3.098]	73.66 [2.900]	4-173145-1
	16.5 [.650]	26	35.6 [1.402]	30.48 [1.200]	2-173145-1
		30	40.6 [1.598]	35.56 [1.400]	1-173145-2
		34	45.7 [1.799]	40.64 [1.600]	2-173145-2
		40	53.3 [2.098]	48.26 [1.900]	1-173145-3
		50	66.0 [2.598]	60.96 [2.400]	1-173145-4
		60	78.7 [3.098]	73.66 [2.900]	1-173145-5

**Contact area and post mating area: 0.00050 [.000020] min. gold over 0.00130 [.000050] min. nickel plated.

**Post Headers with Solder Posts
(Non-Intermateable with AMPMODU Connectors)**

**Post Header
(With 0.55 [.022] Square Post)**

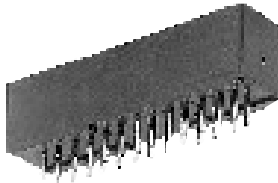

Material and Finish:

Housing—Black glass-filled PBT, 94V-0 rated
Posts—Copper alloy, plated 0.00020 [.000008] gold on contact area, 0.00100-0.00150 [.000040-.000060] tin-lead on solder tail, with entire post underplated 0.00130 [.000050] nickel

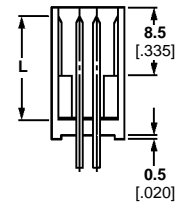
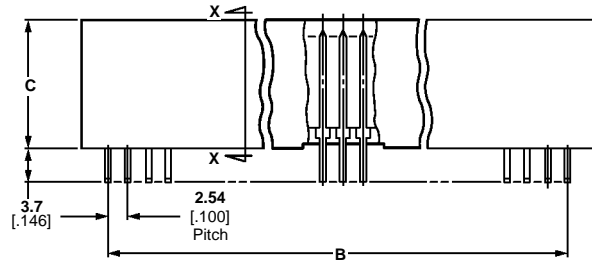
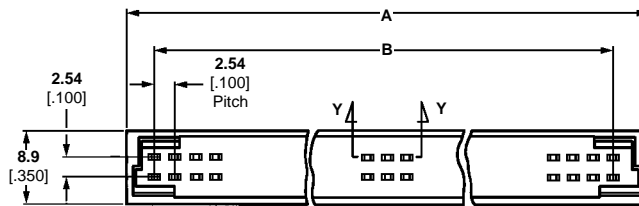

Section Y-Y

Section X-X

PC Board Mounting Dimensions

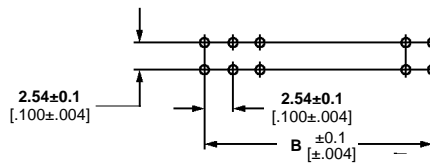
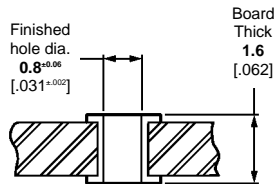

Recommended PC Board Hole Layout

Stacking Dimensions	Post Length L	No. of Pos.	Dimensions (See Note.)			Part Nos. of Post Header Assembly
			A	B	C	
13.9 [.547]	5.8 [.228]	26	38.1 [1.500]	30.48 [1.200]	10.5 [.413]	3-173146-5
		30	43.2 [1.700]	35.56 [1.400]	10.5 [.413]	3-173146-1
		34	48.3 [1.900]	40.64 [1.600]	10.5 [.413]	3-173146-6
		40	55.9 [2.200]	48.26 [1.900]	10.5 [.413]	3-173146-2 3-173146-0*
		50	68.6 [2.700]	60.96 [2.400]	10.5 [.413]	3-173146-3
		60	81.3 [3.200]	73.66 [2.900]	10.5 [.413]	3-173146-4
	7.8 [.307]	26	38.1 [1.500]	30.48 [1.200]	10.5 [.413]	2-173146-1
		30	43.2 [1.700]	35.56 [1.400]	10.5 [.413]	1-173146-7
		34	48.3 [1.900]	40.64 [1.600]	10.5 [.413]	2-173146-2
		40	55.9 [2.200]	48.26 [1.900]	10.5 [.413]	1-173146-8 4-173146-3*
		50	68.6 [2.700]	60.96 [2.400]	10.5 [.413]	1-173146-9
		60	81.3 [3.200]	73.66 [2.900]	10.5 [.413]	2-173146-0

*Contact mating area: 0.00050 [.000020] min. gold over 0.00130 [.000050] min. nickel plated.

**Post Headers with Solder Posts
(Non-Intermateable with AMPMODU Connectors)** (Continued)

Stacking Dimensions	Post Length L	No. of Pos.	Dimensions (See Note.)			Part Nos. of Post Header Assembly
			A	B	C	
19.5 [.768]	11.4 [.449]	26	38.1 [1.500]	30.48 [1.200]	16.1 [.634]	4-173146-1
		30	43.2 [1.700]	35.56 [1.400]	16.1 [.634]	3-173146-7
		34	48.3 [1.900]	40.64 [1.600]	16.1 [.634]	4-173146-2
		40	55.9 [2.200]	48.26 [1.900]	16.1 [.634]	3-173146-8
		50	68.6 [2.700]	60.96 [2.400]	16.1 [.634]	3-173146-9
		60	81.3 [3.200]	73.66 [2.900]	16.1 [.634]	4-173146-0
	13.4 [.528]	26	38.1 [1.500]	30.48 [1.200]	16.1 [.634]	2-173146-8
		30	43.2 [1.700]	35.56 [1.400]	16.1 [.634]	2-173146-4
		34	48.3 [1.900]	40.64 [1.600]	16.1 [.634]	2-173146-9
		40	55.9 [2.200]	48.26 [1.900]	16.1 [.634]	2-173146-5
		50	68.6 [2.700]	60.96 [2.400]	16.1 [.634]	2-173146-6
		60	81.3 [3.200]	73.66 [2.900]	16.1 [.634]	2-173146-7

*Contact mating area: 0.00050 [.000020] min. gold over 0.00130 [.000050] min. nickel plated.

Note: Dimensions are expressed in millimeters; values in brackets are inch equivalents. Chart dimensions are in millimeters over inches.

Application Tooling for AMP ACTION PIN Stacking Connectors

AMP Mini-Press



No. of Pos.	Part No.
40	1-758030-1
50	1-758030-2
60	1-758030-3

The part numbers above include the Mini-Press unit, insertion support plate and press-fit jig.

**Mini-Press Unit
Part No. 1-758030-3**

When ordering a press-fit jig only, consult the table below.

Press-fit Jig (separate order)

No. of Pos.	Part No.
26	907459-1
30	907459-2
34	907459-3
40	907459-4
50	907459-5
60	907459-6

Also, optional insertion support plates are obtainable by separate order to meet your specific requirements for improved board handling.

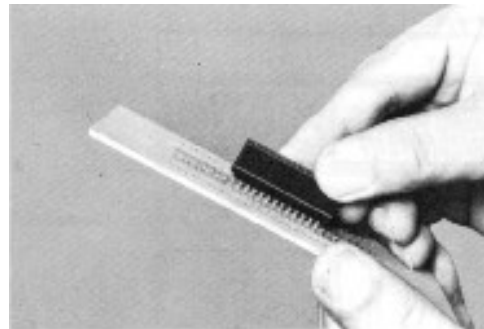

1. Insert connector into the board tentatively (Be sure that connector is in the right direction).

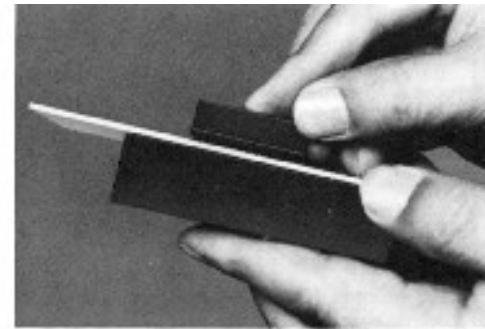

2. Attach insertion support plate to the leg portion of connector from below.



3. Set insertion support plate in place by butting it against Mini-Press platform.

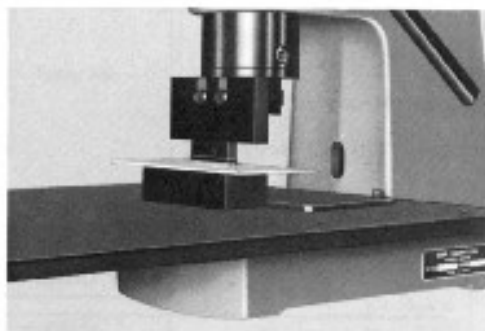

4. By pressing Mini-Press handle down, rest the press-fit jig against connector.

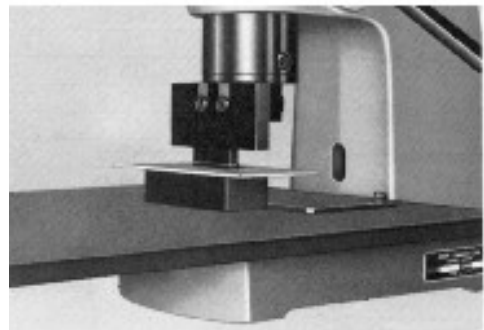

5. Press handle down gently and insert connector into the board.

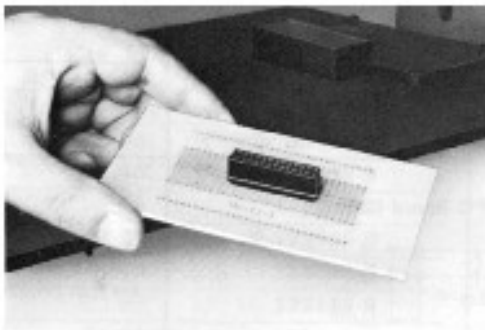

6. Now connector has been mounted to the board securely.

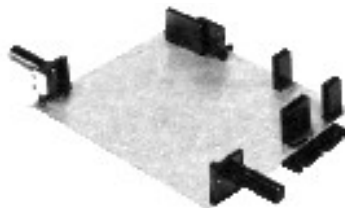

**Insertion Support Unit
(Option)**



Bandolier Posts (Uninsulated)



Material and Finish:

Bandolier—Brass
Posts—Phosphor bronze, plated as follows:
Plating A—Duplex plated .000030 [0.00076] gold on contact area, .000100-.000200 [0.00254-0.00508] tin-lead on solder area, with entire post underplated .000050 [0.00127] nickel
Plating B—Duplex plated .000015 [0.00038] gold on contact area, .000100-.000200 [0.00254-0.00508] tin-lead on solder area, with entire post underplated .000050 [0.00127] nickel
Plating C— .000100-.000200 [0.00254-0.00508] tin-lead over .000050 [0.00127] nickel on entire post

Related Product Data:

Mateable Connectors—Refer to the Mating Post Selection Guide (page 89)

Accessories:

End Shrouds—page 220
Application Tooling—page 170
Technical Documents (page 294):

See mating connector for applicable product and application specifications.

Strip Form Posts (Uninsulated)



Material and Finish:

Posts—Phosphor bronze, plated as follows:
Plating A—Duplex plated .000030 [0.00076] gold on contact area, .000100-.000200 [0.00254-0.00508] tin-lead on solder area, with entire post underplated .000050 [0.00127] nickel
Plating B—Duplex plated .000015 [0.00038] gold on contact area, .000100-.000200 [0.00254-0.00508] tin-lead on solder area, with entire post underplated .000050 [0.00127] nickel
Plating C— .000030 [0.00076] gold over .000050 [0.00127] nickel on entire post
Plating D— .000100-.000200 [0.00254-0.00508] tin-lead over .000050 [0.00127] nickel on entire post

.025 [0.64] Square Posts

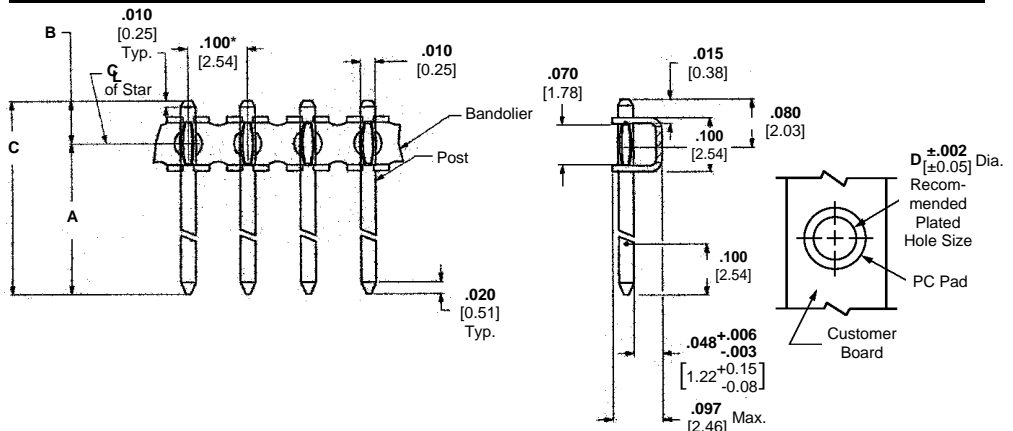

Dimensions				Post Plating/Part Nos.			Bandolier Insertion Head
A	B	C	D	Plating A	Plating B	Plating C	
.353 [8.97]	.071 [1.80]	.424 [10.77]	.034 [0.86]	103577-1	1-103577-3	103577-7	904592-1
.318 [8.08]	.071 [1.80]	.389 [9.88]	.034 [0.86]	103577-3	1-103577-5	103577-9	904591-1
.270 [6.86]	.071 [1.80]	.341 [8.66]	.034 [0.86]	103577-5	1-103577-7	1-103577-1	904590-1
.183 [4.65]	.097 [2.46]	.280 [7.11]	.031 [0.79]	146079-1	—	—	—
			.031 [0.79]	—	—	146079-3	—

- Notes:** 1. Posts can be applied using **Hand Tool 91419-1**. *Point of measurement for plating thickness.
 2. Approximate posts per reel—30,000.
 3. The Bandolier Insertion head can be used on the Comp-U-Sertor II machine or the Modular Insertion System Bench machine (see page 170).

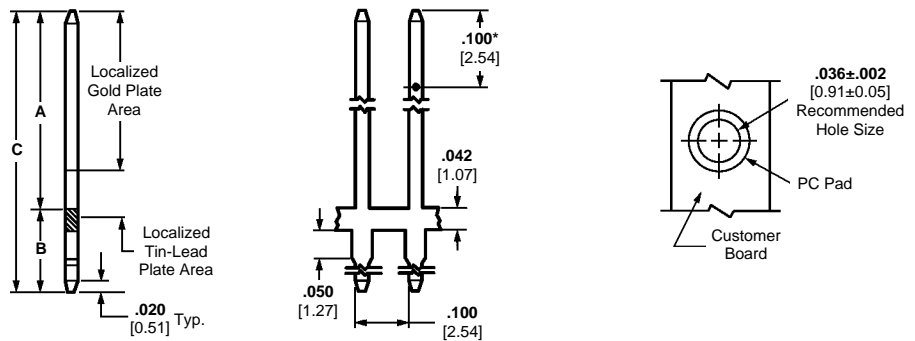

Dimensions			Post Plating/Part Nos.				Post/Tab Insertion Head
A	B	C	Plating A	Plating B	Plating C	Plating D	
.210 [5.33]	.227 [5.77]	.437 [11.10]	—	—	87878-6	1-87022-4	—
.278 [7.06]	.165 [4.19]	.443 [11.25]	87623-1	87623-4	87022-1	1-87022-0	904507-1
.278 [7.06]	.284 [7.21]	.562 [14.27]	—	—	1-87022-3	—	—
.278 [7.06]	.738 [18.75]	1.016 [25.81]	—	—	87022-2	87022-4	—
.318 [8.08]	.165 [4.19]	.483 [14.27]	—	—	4-87022-1	4-87022-3	—

- Notes:** 1. Approximate Posts per reel—20,000. *Point of measurement for plating thickness.
 2. Other post lengths are available, consult Tyco Electronics.
 3. The Post/Tab Insertion Head can be used on the Comp-U-Sertor II machine or the Modular Insertion System Bench machine (see page 170).

Square Posts Bandolier and Strip Form

5

AMPMODU .025 [0.64] Square Continuous Posts

Features of .025 [0.64] Square Continuous Posts

- Brass drawn wire for posts
- .400 to 1.000 [10.16 to 25.40] overall pin length (.010 [0.25] increments)
- Plating Options:
Tin-Lead
15µ in. gold
30µ in. gold
- Star feature also available

Benefits

- Less expensive than bandolier style posts
- Can be placed on printed circuit boards at any desired centerline
- Less scrap material (no carrier strip)

Technical Documents (page 294):
Application Specification
114-13011



Photo 110290



Photo 109148-1

Tyco Electronics now offers AMPMODU .025 [0.64] Square Continuous Posts. These posts can be used instead of the original posts that come on a bandolier style carrier strip. These posts are on a reel, but the posts are 'notched' at the desired length (no carrier strip is needed). This feature allows more versatility by providing posts lengths from .400 to 1.000 [10.16 to 25.40], available in increments of .010 [0.25].

The posts are brass drawn wire and are inserted into a printed circuit board via application tooling at any centerline configuration. They can be used for wire

wrap applications or mated to a receptacle.

The current rating is 3 amps. The posts are available plated with tin lead, 15µ in. gold, or 30µ in. gold. Other platings are available upon request.

The application tooling needed is a modular head (Part Number 904641-1) which is placed on the AMP Comp-U-Sertor machine (Part Number 122300-1.)

Pre-Plated Tin

Part Number		Description Post Length
Square	Square with Star	
147333-1	147433-1	0.400 [10.16]
147333-2	147433-2	0.410 [10.41]
147333-3	147433-3	0.420 [10.67]
147333-4	147433-4	0.430 [10.92]
147333-5	147433-5	0.440 [11.18]
147333-6	147433-6	0.450 [11.43]
147333-7	147433-7	0.460 [11.68]
147333-8	147433-8	0.470 [11.94]
147333-9	147433-9	0.480 [12.19]
1-147333-0	1-147433-0	0.490 [12.45]
1-147333-1	1-147433-1	0.500 [12.70]
1-147333-2	1-147433-2	0.510 [12.95]
1-147333-3	1-147433-3	0.520 [13.21]
1-147333-4	1-147433-4	0.530 [13.46]
1-147333-5	1-147433-5	0.540 [13.72]
1-147333-6	1-147433-6	0.550 [13.97]
1-147333-7	1-147433-7	0.560 [14.22]
1-147333-8	1-147433-8	0.570 [14.48]
1-147333-9	1-147433-9	0.580 [14.73]
2-147333-0	2-147433-0	0.590 [14.99]
2-147333-1	2-147433-1	0.600 [15.24]

Part Number		Description Post Length
Square	Square with Star	
2-147333-2	2-147433-2	0.610 [15.49]
2-147333-3	2-147433-3	0.620 [15.75]
2-147333-4	2-147433-4	0.630 [16.00]
2-147333-5	2-147433-5	0.640 [16.26]
2-147333-6	2-147433-6	0.650 [16.51]
2-147333-7	2-147433-7	0.660 [16.76]
2-147333-8	2-147433-8	0.670 [17.02]
2-147333-9	2-147433-9	0.680 [17.27]
3-147333-0	3-147433-0	0.690 [17.53]
3-147333-1	3-147433-1	0.700 [17.78]
3-147333-2	3-147433-2	0.710 [18.03]
3-147333-3	3-147433-3	0.720 [18.29]
3-147333-4	3-147433-4	0.730 [18.54]
3-147333-5	3-147433-5	0.740 [18.80]
3-147333-6	3-147433-6	0.750 [19.05]
3-147333-7	3-147433-7	0.760 [19.30]
3-147333-8	3-147433-8	0.770 [19.56]
3-147333-9	3-147433-9	0.780 [19.81]
4-147333-0	4-147433-0	0.790 [20.07]
4-147333-1	4-147433-1	0.800 [20.32]
4-147333-2	4-147433-2	0.810 [20.57]

Part Number		Description Post Length
Square	Square with Star	
4-147333-3	4-147433-3	0.820 [20.83]
4-147333-4	4-147433-4	0.830 [21.08]
4-147333-5	4-147433-5	0.840 [21.34]
4-147333-6	4-147433-6	0.850 [21.59]
4-147333-7	4-147433-7	0.860 [21.84]
4-147333-8	4-147433-8	0.870 [22.10]
4-147333-9	4-147433-9	0.880 [22.35]
5-147333-0	5-147433-0	0.890 [22.61]
5-147333-1	5-147433-1	0.900 [22.86]
5-147333-2	5-147433-2	0.910 [23.11]
5-147333-3	5-147433-3	0.920 [23.37]
5-147333-4	5-147433-4	0.930 [23.62]
5-147333-5	5-147433-5	0.940 [23.88]
5-147333-6	5-147433-6	0.950 [24.13]
5-147333-7	5-147433-7	0.960 [24.38]
5-147333-8	5-147433-8	0.970 [24.64]
5-147333-9	5-147433-9	0.980 [24.89]
6-147333-0	6-147433-0	0.990 [25.15]
6-147333-1	6-147433-1	1.000 [25.40]

Pre-Plated 15µ in. Gold

Part Number		Description Post Length
Square	Square with Star	
147334-1	147434-1	0.400 [10.16]
147334-2	147434-2	0.410 [10.41]
147334-3	147434-3	0.420 [10.67]
147334-4	147434-4	0.430 [10.92]
147334-5	147434-5	0.440 [11.18]
147334-6	147434-6	0.450 [11.43]
147334-7	147434-7	0.460 [11.68]
147334-8	147434-8	0.470 [11.94]
147334-9	147434-9	0.480 [12.19]
1-147334-0	1-147434-0	0.490 [12.45]
1-147334-1	1-147434-1	0.500 [12.70]
1-147334-2	1-147434-2	0.510 [12.95]
1-147334-3	1-147434-3	0.520 [13.21]
1-147334-4	1-147434-4	0.530 [13.46]
1-147334-5	1-147434-5	0.540 [13.72]
1-147334-6	1-147434-6	0.550 [13.97]
1-147334-7	1-147434-7	0.560 [14.22]
1-147334-8	1-147434-8	0.570 [14.48]
1-147334-9	1-147434-9	0.580 [14.73]
2-147334-0	2-147434-0	0.590 [14.99]
2-147334-1	2-147434-1	0.600 [15.24]

Part Number		Description Post Length
Square	Square with Star	
2-147334-2	2-147434-2	0.610 [15.49]
2-147334-3	2-147434-3	0.620 [15.75]
2-147334-4	2-147434-4	0.630 [16.00]
2-147334-5	2-147434-5	0.640 [16.26]
2-147334-6	2-147434-6	0.650 [16.51]
2-147334-7	2-147434-7	0.660 [16.76]
2-147334-8	2-147434-8	0.670 [17.02]
2-147334-9	2-147434-9	0.680 [17.27]
3-147334-0	3-147434-0	0.690 [17.53]
3-147334-1	3-147434-1	0.700 [17.78]
3-147334-2	3-147434-2	0.710 [18.03]
3-147334-3	3-147434-3	0.720 [18.29]
3-147334-4	3-147434-4	0.730 [18.54]
3-147334-5	3-147434-5	0.740 [18.80]
3-147334-6	3-147434-6	0.750 [19.05]
3-147334-7	3-147434-7	0.760 [19.30]
3-147334-8	3-147434-8	0.770 [19.56]
3-147334-9	3-147434-9	0.780 [19.81]
4-147334-0	4-147434-0	0.790 [20.07]
4-147334-1	4-147434-1	0.800 [20.32]
4-147334-2	4-147434-2	0.810 [20.57]

Part Number		Description Post Length
Square	Square with Star	
4-147334-3	4-147434-3	0.820 [20.83]
4-147334-4	4-147434-4	0.830 [21.08]
4-147334-5	4-147434-5	0.840 [21.34]
4-147334-6	4-147434-6	0.850 [21.59]
4-147334-7	4-147434-7	0.860 [21.84]
4-147334-8	4-147434-8	0.870 [22.10]
4-147334-9	4-147434-9	0.880 [22.35]
5-147334-0	5-147434-0	0.890 [22.61]
5-147334-1	5-147434-1	0.900 [22.86]
5-147334-2	5-147434-2	0.910 [23.11]
5-147334-3	5-147434-3	0.920 [23.37]
5-147334-4	5-147434-4	0.930 [23.62]
5-147334-5	5-147434-5	0.940 [23.88]
5-147334-6	5-147434-6	0.950 [24.13]
5-147334-7	5-147434-7	0.960 [24.38]
5-147334-8	5-147434-8	0.970 [24.64]
5-147334-9	5-147434-9	0.980 [24.89]
6-147334-0	6-147434-0	0.990 [25.15]
6-147334-1	6-147434-1	1.000 [25.40]

Pre-Plated 30µ in. Gold

Part Number		Description Post Length
Square	Square with Star	
147335-1	147435-1	0.400 [10.16]
147335-2	147435-2	0.410 [10.41]
147335-3	147435-3	0.420 [10.67]
147335-4	147435-4	0.430 [10.92]
147335-5	147435-5	0.440 [11.18]
147335-6	147435-6	0.450 [11.43]
147335-7	147435-7	0.460 [11.68]
147335-8	147435-8	0.470 [11.94]
147335-9	147435-9	0.480 [12.19]
1-147335-0	1-147435-0	0.490 [12.45]
1-147335-1	1-147435-1	0.500 [12.70]
1-147335-2	1-147435-2	0.510 [12.95]
1-147335-3	1-147435-3	0.520 [13.21]
1-147335-4	1-147435-4	0.530 [13.46]
1-147335-5	1-147435-5	0.540 [13.72]
1-147335-6	1-147435-6	0.550 [13.97]
1-147335-7	1-147435-7	0.560 [14.22]
1-147335-8	1-147435-8	0.570 [14.48]
1-147335-9	1-147435-9	0.580 [14.73]
2-147335-0	2-147435-0	0.590 [14.99]
2-147335-1	2-147435-1	0.600 [15.24]

Part Number		Description Post Length
Square	Square with Star	
2-147335-2	2-147435-2	0.610 [15.49]
2-147335-3	2-147435-3	0.620 [15.75]
2-147335-4	2-147435-4	0.630 [16.00]
2-147335-5	2-147435-5	0.640 [16.26]
2-147335-6	2-147435-6	0.650 [16.51]
2-147335-7	2-147435-7	0.660 [16.76]
2-147335-8	2-147435-8	0.670 [17.02]
2-147335-9	2-147435-9	0.680 [17.27]
3-147335-0	3-147435-0	0.690 [17.53]
3-147335-1	3-147435-1	0.700 [17.78]
3-147335-2	3-147435-2	0.710 [18.03]
3-147335-3	3-147435-3	0.720 [18.29]
3-147335-4	3-147435-4	0.730 [18.54]
3-147335-5	3-147435-5	0.740 [18.80]
3-147335-6	3-147435-6	0.750 [19.05]
3-147335-7	3-147435-7	0.760 [19.30]
3-147335-8	3-147435-8	0.770 [19.56]
3-147335-9	3-147435-9	0.780 [19.81]
4-147335-0	4-147435-0	0.790 [20.07]
4-147335-1	4-147435-1	0.800 [20.32]
4-147335-2	4-147435-2	0.810 [20.57]

Part Number		Description Post Length
Square	Square with Star	
4-147335-3	4-147435-3	0.820 [20.83]
4-147335-4	4-147435-4	0.830 [21.08]
4-147335-5	4-147435-5	0.840 [21.34]
4-147335-6	4-147435-6	0.850 [21.59]
4-147335-7	4-147435-7	0.860 [21.84]
4-147335-8	4-147435-8	0.870 [22.10]
4-147335-9	4-147435-9	0.880 [22.35]
5-147335-0	5-147435-0	0.890 [22.61]
5-147335-1	5-147435-1	0.900 [22.86]
5-147335-2	5-147435-2	0.910 [23.11]
5-147335-3	5-147435-3	0.920 [23.37]
5-147335-4	5-147435-4	0.930 [23.62]
5-147335-5	5-147435-5	0.940 [23.88]
5-147335-6	5-147435-6	0.950 [24.13]
5-147335-7	5-147435-7	0.960 [24.38]
5-147335-8	5-147435-8	0.970 [24.64]
5-147335-9	5-147435-9	0.980 [24.89]
6-147335-0	6-147435-0	0.990 [25.15]
6-147335-1	6-147435-1	1.000 [25.40]

5
 .025 Square
 Continuous Posts

AMPMODU .045 [1.14] Square Continuous Posts

Features of .045 [1.14] Square Continuous Posts

- Brass drawn wire for posts
- .400 to 1.000 [10.16 to 25.40] overall pin length (.010 [0.25] increments)
- Plating Options:
Tin-Lead
15µ in. gold
30µ in. gold
- Star feature also available

Benefits

- Less expensive than bandolier style posts
- Can be placed on printed circuit boards at any desired centerline
- Less scrap material (no carrier strip)

Technical Documents (page 294):

Application Specification
114-13011

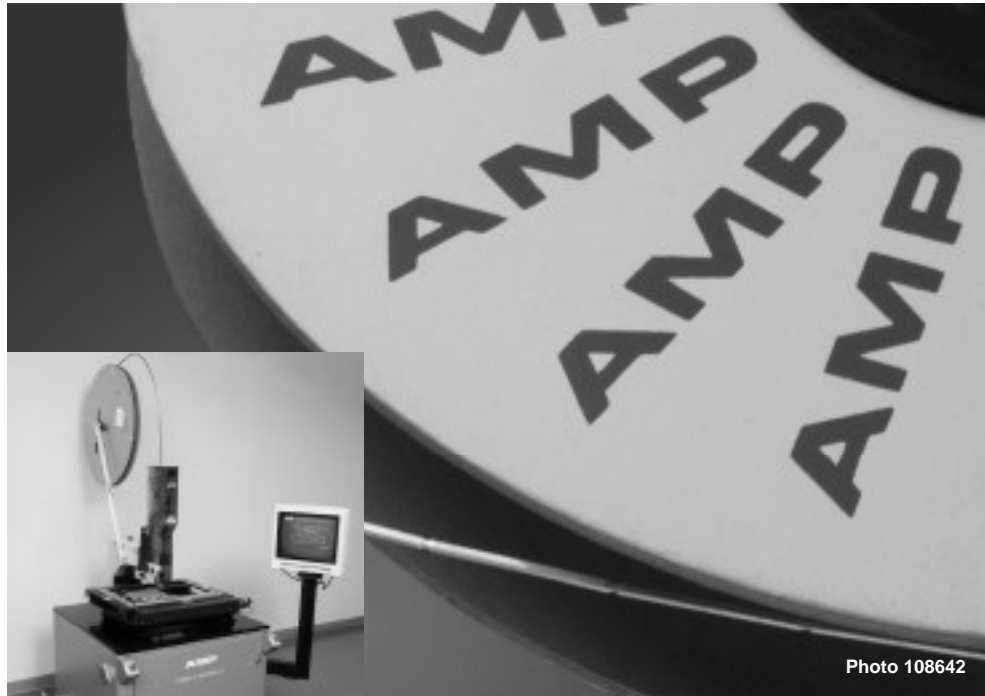

Photo 108642



Photo 109148-1

Tyco Electronics now offers AMPMODU .045 [1.14] Square Continuous Posts. These posts can be used instead of the original posts that come on a bandolier style carrier strip. These posts are on a reel, but the posts are 'notched' at the desired length (no carrier strip is needed). This feature allows more versatility by providing posts lengths from .400 to 1.000 [10.16 to 25.40], available in increments of .010 [0.25].

The posts are brass drawn wire and are inserted into a printed circuit board via application tooling at any centerline configuration. They can be used for wire

wrap applications or mated to a receptacle.

Potential industries include: building systems, commercial/home equipment, household appliances, home power tools and equipment.

The current rating is 7 amps. The posts are available plated with tin lead, 15µ in. gold, or 30µ in. gold. Other platings are available upon request.

The application tooling needed is a modular head (Part Number 904640-1) which is placed on the AMP Comp-U-Sertor machine (Part Number 122300-1.)

Pre-Plated Tin

Part Number		Description Post Length
Square	Square with Star	
147070-1	147436-1	0.400 [10.16]
147070-2	147436-2	0.410 [10.41]
147070-3	147436-3	0.420 [10.67]
147070-4	147436-4	0.430 [10.92]
147070-5	147436-5	0.440 [11.18]
147070-6	147436-6	0.450 [11.43]
147070-7	147436-7	0.460 [11.68]
147070-8	147436-8	0.470 [11.94]
147070-9	147436-9	0.480 [12.19]
1-147070-0	1-147436-0	0.490 [12.45]
1-147070-1	1-147436-1	0.500 [12.70]
1-147070-2	1-147436-2	0.510 [12.95]
1-147070-3	1-147436-3	0.520 [13.21]
1-147070-4	1-147436-4	0.530 [13.46]
1-147070-5	1-147436-5	0.540 [13.72]
1-147070-6	1-147436-6	0.550 [13.97]
1-147070-7	1-147436-7	0.560 [14.22]
1-147070-8	1-147436-8	0.570 [14.48]
1-147070-9	1-147436-9	0.580 [14.73]
2-147070-0	2-147436-0	0.590 [14.99]
2-147070-1	2-147436-1	0.600 [15.24]

Part Number		Description Post Length
Square	Square with Star	
2-147070-2	2-147436-2	0.610 [15.49]
2-147070-3	2-147436-3	0.620 [15.75]
2-147070-4	2-147436-4	0.630 [16.00]
2-147070-5	2-147436-5	0.640 [16.26]
2-147070-6	2-147436-6	0.650 [16.51]
2-147070-7	2-147436-7	0.660 [16.76]
2-147070-8	2-147436-8	0.670 [17.02]
2-147070-9	2-147436-9	0.680 [17.27]
3-147070-0	3-147436-0	0.690 [17.53]
3-147070-1	3-147436-1	0.700 [17.78]
3-147070-2	3-147436-2	0.710 [18.03]
3-147070-3	3-147436-3	0.720 [18.29]
3-147070-4	3-147436-4	0.730 [18.54]
3-147070-5	3-147436-5	0.740 [18.80]
3-147070-6	3-147436-6	0.750 [19.05]
3-147070-7	3-147436-7	0.760 [19.30]
3-147070-8	3-147436-8	0.770 [19.56]
3-147070-9	3-147436-9	0.780 [19.81]
4-147070-0	4-147436-0	0.790 [20.07]
4-147070-1	4-147436-1	0.800 [20.32]
4-147070-2	4-147436-2	0.810 [20.57]

Part Number		Description Post Length
Square	Square with Star	
4-147070-3	4-147436-3	0.820 [20.83]
4-147070-4	4-147436-4	0.830 [21.08]
4-147070-5	4-147436-5	0.840 [21.34]
4-147070-6	4-147436-6	0.850 [21.59]
4-147070-7	4-147436-7	0.860 [21.84]
4-147070-8	4-147436-8	0.870 [22.10]
4-147070-9	4-147436-9	0.880 [22.35]
5-147070-0	5-147436-0	0.890 [22.61]
5-147070-1	5-147436-1	0.900 [22.86]
5-147070-2	5-147436-2	0.910 [23.11]
5-147070-3	5-147436-3	0.920 [23.37]
5-147070-4	5-147436-4	0.930 [23.62]
5-147070-5	5-147436-5	0.940 [23.88]
5-147070-6	5-147436-6	0.950 [24.13]
5-147070-7	5-147436-7	0.960 [24.38]
5-147070-8	5-147436-8	0.970 [24.64]
5-147070-9	5-147436-9	0.980 [24.89]
6-147070-0	6-147436-0	0.990 [25.15]
6-147070-1	6-147436-1	1.000 [25.40]

Pre-Plated 15µ in. Gold

Part Number		Description Post Length
Square	Square with Star	
147071-1	147437-1	0.400 [10.16]
147071-2	147437-2	0.410 [10.41]
147071-3	147437-3	0.420 [10.67]
147071-4	147437-4	0.430 [10.92]
147071-5	147437-5	0.440 [11.18]
147071-6	147437-6	0.450 [11.43]
147071-7	147437-7	0.460 [11.68]
147071-8	147437-8	0.470 [11.94]
147071-9	147437-9	0.480 [12.19]
1-147071-0	1-147437-0	0.490 [12.45]
1-147071-1	1-147437-1	0.500 [12.70]
1-147071-2	1-147437-2	0.510 [12.95]
1-147071-3	1-147437-3	0.520 [13.21]
1-147071-4	1-147437-4	0.530 [13.46]
1-147071-5	1-147437-5	0.540 [13.72]
1-147071-6	1-147437-6	0.550 [13.97]
1-147071-7	1-147437-7	0.560 [14.22]
1-147071-8	1-147437-8	0.570 [14.48]
1-147071-9	1-147437-9	0.580 [14.73]
2-147071-0	2-147437-0	0.590 [14.99]
2-147071-1	2-147437-1	0.600 [15.24]

Part Number		Description Post Length
Square	Square with Star	
2-147071-2	2-147437-2	0.610 [15.49]
2-147071-3	2-147437-3	0.620 [15.75]
2-147071-4	2-147437-4	0.630 [16.00]
2-147071-5	2-147437-5	0.640 [16.26]
2-147071-6	2-147437-6	0.650 [16.51]
2-147071-7	2-147437-7	0.660 [16.76]
2-147071-8	2-147437-8	0.670 [17.02]
2-147071-9	2-147437-9	0.680 [17.27]
3-147071-0	3-147437-0	0.690 [17.53]
3-147071-1	3-147437-1	0.700 [17.78]
3-147071-2	3-147437-2	0.710 [18.03]
3-147071-3	3-147437-3	0.720 [18.29]
3-147071-4	3-147437-4	0.730 [18.54]
3-147071-5	3-147437-5	0.740 [18.80]
3-147071-6	3-147437-6	0.750 [19.05]
3-147071-7	3-147437-7	0.760 [19.30]
3-147071-8	3-147437-8	0.770 [19.56]
3-147071-9	3-147437-9	0.780 [19.81]
4-147071-0	4-147437-0	0.790 [20.07]
4-147071-1	4-147437-1	0.800 [20.32]
4-147071-2	4-147437-2	0.810 [20.57]

Part Number		Description Post Length
Square	Square with Star	
4-147071-3	4-147437-3	0.820 [20.83]
4-147071-4	4-147437-4	0.830 [21.08]
4-147071-5	4-147437-5	0.840 [21.34]
4-147071-6	4-147437-6	0.850 [21.59]
4-147071-7	4-147437-7	0.860 [21.84]
4-147071-8	4-147437-8	0.870 [22.10]
4-147071-9	4-147437-9	0.880 [22.35]
5-147071-0	5-147437-0	0.890 [22.61]
5-147071-1	5-147437-1	0.900 [22.86]
5-147071-2	5-147437-2	0.910 [23.11]
5-147071-3	5-147437-3	0.920 [23.37]
5-147071-4	5-147437-4	0.930 [23.62]
5-147071-5	5-147437-5	0.940 [23.88]
5-147071-6	5-147437-6	0.950 [24.13]
5-147071-7	5-147437-7	0.960 [24.38]
5-147071-8	5-147437-8	0.970 [24.64]
5-147071-9	5-147437-9	0.980 [24.89]
6-147071-0	6-147437-0	0.990 [25.15]
6-147071-1	6-147437-1	1.000 [25.40]

Pre-Plated 30µ in. Gold

Part Number		Description Post Length
Square	Square with Star	
147072-1	147438-1	0.400 [10.16]
147072-2	147438-2	0.410 [10.41]
147072-3	147438-3	0.420 [10.67]
147072-4	147438-4	0.430 [10.92]
147072-5	147438-5	0.440 [11.18]
147072-6	147438-6	0.450 [11.43]
147072-7	147438-7	0.460 [11.68]
147072-8	147438-8	0.470 [11.94]
147072-9	147438-9	0.480 [12.19]
1-147072-0	1-147438-0	0.490 [12.45]
1-147072-1	1-147438-1	0.500 [12.70]
1-147072-2	1-147438-2	0.510 [12.95]
1-147072-3	1-147438-3	0.520 [13.21]
1-147072-4	1-147438-4	0.530 [13.46]
1-147072-5	1-147438-5	0.540 [13.72]
1-147072-6	1-147438-6	0.550 [13.97]
1-147072-7	1-147438-7	0.560 [14.22]
1-147072-8	1-147438-8	0.570 [14.48]
1-147072-9	1-147438-9	0.580 [14.73]
2-147072-0	2-147438-0	0.590 [14.99]
2-147072-1	2-147438-1	0.600 [15.24]

Part Number		Description Post Length
Square	Square with Star	
2-147072-2	2-147438-2	0.610 [15.49]
2-147072-3	2-147438-3	0.620 [15.75]
2-147072-4	2-147438-4	0.630 [16.00]
2-147072-5	2-147438-5	0.640 [16.26]
2-147072-6	2-147438-6	0.650 [16.51]
2-147072-7	2-147438-7	0.660 [16.76]
2-147072-8	2-147438-8	0.670 [17.02]
2-147072-9	2-147438-9	0.680 [17.27]
3-147072-0	3-147438-0	0.690 [17.53]
3-147072-1	3-147438-1	0.700 [17.78]
3-147072-2	3-147438-2	0.710 [18.03]
3-147072-3	3-147438-3	0.720 [18.29]
3-147072-4	3-147438-4	0.730 [18.54]
3-147072-5	3-147438-5	0.740 [18.80]
3-147072-6	3-147438-6	0.750 [19.05]
3-147072-7	3-147438-7	0.760 [19.30]
3-147072-8	3-147438-8	0.770 [19.56]
3-147072-9	3-147438-9	0.780 [19.81]
4-147072-0	4-147438-0	0.790 [20.07]
4-147072-1	4-147438-1	0.800 [20.32]
4-147072-2	4-147438-2	0.810 [20.57]

Part Number		Description Post Length
Square	Square with Star	
4-147072-3	4-147438-3	0.820 [20.83]
4-147072-4	4-147438-4	0.830 [21.08]
4-147072-5	4-147438-5	0.840 [21.34]
4-147072-6	4-147438-6	0.850 [21.59]
4-147072-7	4-147438-7	0.860 [21.84]
4-147072-8	4-147438-8	0.870 [22.10]
4-147072-9	4-147438-9	0.880 [22.35]
5-147072-0	5-147438-0	0.890 [22.61]
5-147072-1	5-147438-1	0.900 [22.86]
5-147072-2	5-147438-2	0.910 [23.11]
5-147072-3	5-147438-3	0.920 [23.37]
5-147072-4	5-147438-4	0.930 [23.62]
5-147072-5	5-147438-5	0.940 [23.88]
5-147072-6	5-147438-6	0.950 [24.13]
5-147072-7	5-147438-7	0.960 [24.38]
5-147072-8	5-147438-8	0.970 [24.64]
5-147072-9	5-147438-9	0.980 [24.89]
6-147072-0	6-147438-0	0.990 [25.15]
6-147072-1	6-147438-1	1.000 [25.40]

5
 .045 Square
 Continuous Posts

Receptacle Assemblies, Horizontal Mount

Product Facts

- All receptacle assemblies are end stackable
- Contact design employs dual cantilever beams with built-in anti-overstress feature
- Closed entry housings help prevent post stubbing
- Wide range of sizes available
- Other versions available upon request
- Housings made of high temperature, surface mount compatible thermoplastic material, 94V-0 rated
- Duplex gold and bright tin-lead plated contacts have full nickel underplate
- Housings feature PC board standoffs
- Solder tails accommodate a PC board thickness of .062 [1.57]
- Recognized under the Component Program of Underwriters Laboratories Inc., File No. E28476
- Certified by Canadian Standards Association, File No. LR 7189

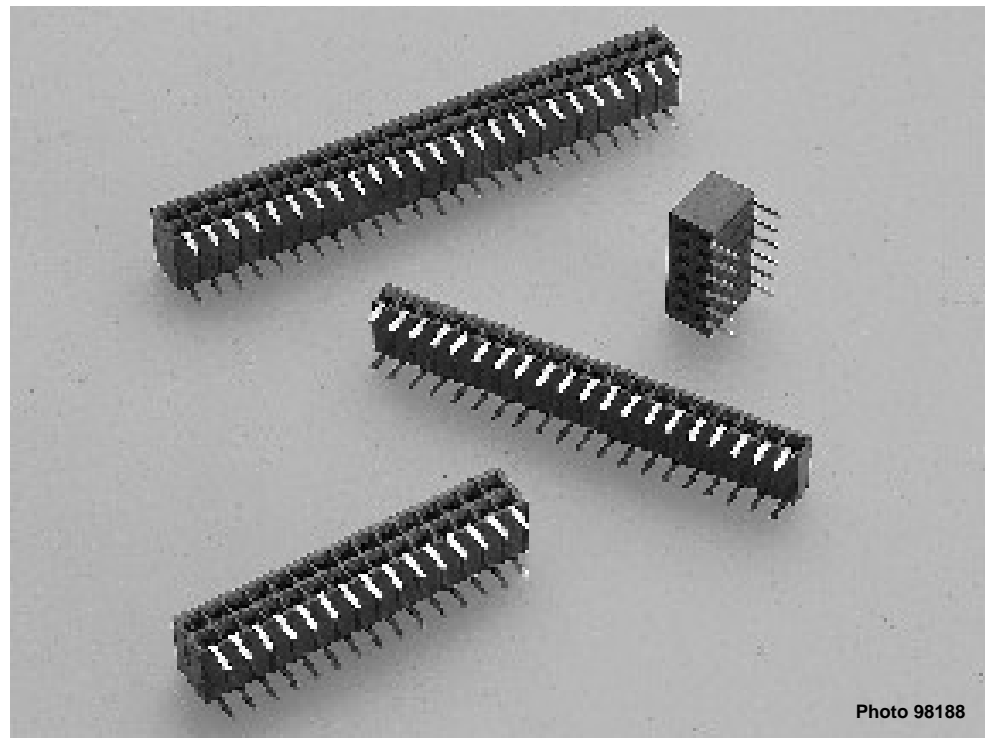

Photo 98188

Horizontal Mount receptacle assemblies are designed to reliably and economically meet the packaging and interconnection requirements of today's electronics industry, generally for applications using the mother/daughter board arrangement.

This product line is offered in both single and double row configurations. The .100 [2.54] centerline

assemblies are available in a wide range of position sizes. They have end stacking capability which give the added advantage of flexibility.

The housings are made of high temperature, surface mount compatible thermoplastic material that is 94V-0 rated. Contacts are phosphor bronze, fully underplated with nickel to help prevent corrosion and are available in three plating options.

The receptacle contact is an established proven design with a fully enclosed, one-piece "box" to protect the contact area. In addition, the receptacle contact has dual cantilever beams with a built-in anti-overstress feature. Standard solder tails accommodate a board thickness of .062 [1.57].

Performance Characteristics

Mechanical Characteristics:

- Mating Force**—6.0 oz. [1.67N] per contact (max.)
- Unmating Force**—.75 oz. [0.21N] per contact (min.) during third mating cycle
- Durability**—200 cycles

Environmental Characteristics:

- Operating Temperature**—
-55°C to +125°C

Electrical Characteristics:

- Current Rating**—3.0 amperes (max.) for single contact; 2.0 amperes (max.) per contact when connector is fully energized
- Contact Resistance**—12 milliohms (max.)
- Insulation Resistance**—5000 megohms (min.) between adjacent contacts
- Dielectric Withstanding Voltage (at sea level)**—750 V rms

Horizontal Mount, Receptacle Assemblies

5

**Mod II Receptacle Assemblies, Single-Row,
.100 [2.54] Centerline**

**Closed Entry, End Stackable,
Short Point-of-Contact,
with Standoffs**

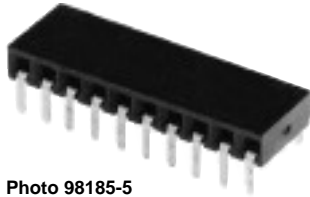

Photo 98185-5

Material and Finish:

Housing—Black thermoplastic, 94V-0 rated, high temperature, surface mount compatible

Contacts—Phosphor bronze, plated as follows:

Plating A—Duplex .000030 [0.00076] gold on contact area, .000150-.000300 [0.00381-0.00762] tin-lead on solder area all over .000050 [0.00127] nickel

Plating B—Duplex .000010 [0.000254] gold on contact area, .000150-.000300 [0.00381-0.00762] tin-lead on solder area all over .000050 [0.00127] nickel

Plating C—.000100-.000200 [0.00254-0.00508] tin-lead over .000050 [0.00127] nickel

Related Product Data:

Mateable Headers—Refer to the Mating Post Selection Guide (page 89)

Performance Characteristics—page 185

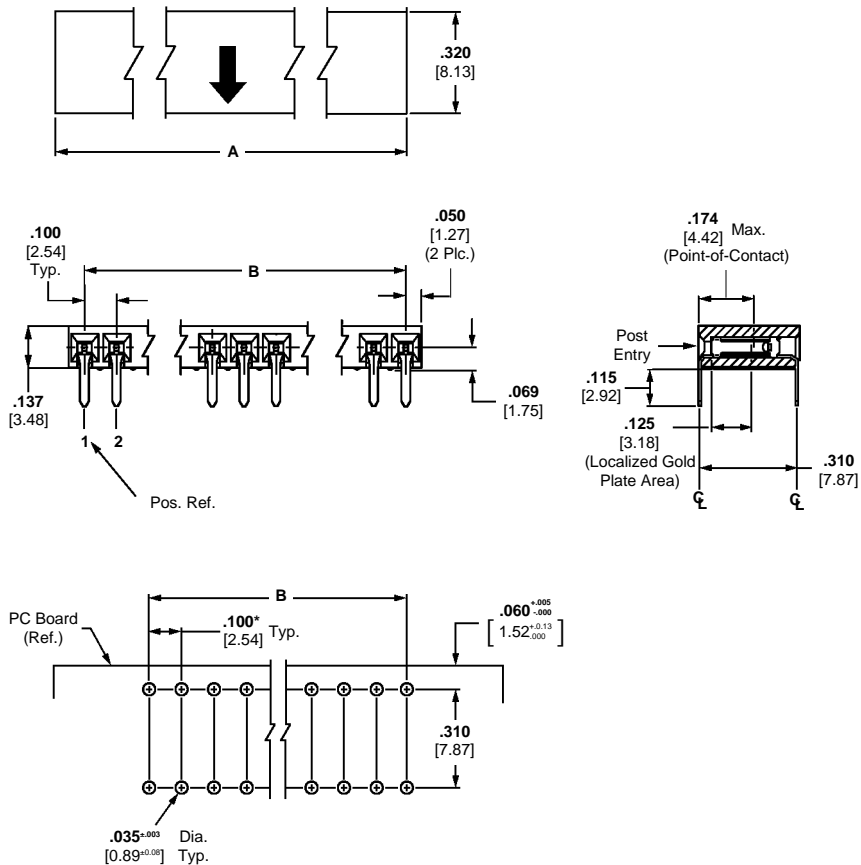

**Recommended PC Board Hole Layout
(for .062 [1.57] thick PC board)**

*±.003 [±0.08] tolerances not to accumulate within one connector pattern.

Technical Documents (page 294):

Product Specification 108-25026

Application Specification 114-25018

Additional receptacle assembly sizes are available; minimum order quantities may apply. Consult Tyco Electronics.

Keying Plug



Part No. 86286-1

(Plugs into receptacle contact)

Material—Natural color nylon

No. of Pos.	Dimensions		Contact Plating/Part Nos.		
	A	B	Plating A	Plating B	Plating C
2	.200 [5.08]	.100 [2.54]	535676-1	146139-1	535677-5
3	.300 [7.62]	.200 [5.08]	535676-2	146139-2	535677-6
4	.400 [10.16]	.300 [7.62]	535676-3	146139-3	535677-7
5	.500 [12.70]	.400 [10.16]	535676-4	146139-4	535677-8
6	.600 [15.24]	.500 [12.70]	535676-5	146139-5	535677-1
7	.700 [17.78]	.600 [15.24]	535676-6	146139-6	535677-2
8	.800 [20.32]	.700 [17.78]	535676-7	146139-7	535677-9
9	.900 [22.86]	.800 [20.32]	535676-8	146139-8	1-535677-0
10	1.000 [25.40]	.900 [22.86]	535676-9	146139-9	1-535677-1
11	1.100 [27.94]	1.000 [25.40]	1-535676-0	1-146139-0	1-535677-2
12	1.200 [30.48]	1.100 [27.94]	1-535676-1	1-146139-1	1-535677-3
13	1.300 [33.02]	1.200 [30.48]	1-535676-2	1-146139-2	535677-3
14	1.400 [35.56]	1.300 [33.02]	1-535676-3	1-146139-3	1-535677-4
15	1.500 [38.10]	1.400 [35.56]	1-535676-4	1-146139-4	1-535677-5
16	1.600 [40.64]	1.500 [38.10]	1-535676-5	1-146139-5	1-535677-6
17	1.700 [43.18]	1.600 [40.64]	1-535676-6	1-146139-6	1-535677-7
18	1.800 [45.72]	1.700 [43.18]	1-535676-7	1-146139-7	1-535677-8
19	1.900 [48.26]	1.800 [45.72]	1-535676-8	1-146139-8	1-535677-9
20	2.000 [50.80]	1.900 [48.26]	1-535676-9	1-146139-9	2-535677-0
30	3.000 [76.20]	2.900 [73.66]	2-535676-9	2-146139-9	2-535677-1
40	4.000 [101.60]	3.900 [99.06]	3-535676-9	3-146139-9	2-535677-2

Note: 1. Tyco Electronics recommends mating gold or duplex plated headers with duplex plated receptacle assemblies.

Horizontal Mount, Receptacle Assemblies

5

**Mod II Receptacle Assemblies, Double-Row,
.100 x .100 [2.54 x 2.54] Centerlines**

**Closed Entry, End Stackable,
Short Point-of-Contact,
with Standoffs**

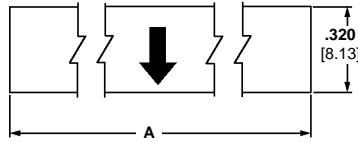
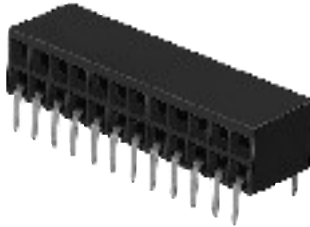

Material and Finish:

Housing—Black thermoplastic, 94V-0 rated, high temperature, surface mount compatible

Contacts—Phosphor bronze, plated as follows:

Plating A—Duplex .000030 [0.00076] gold on contact area, .000150-.000300 [0.00381-0.00762] tin-lead on solder area all over .000050 [0.00127] nickel

Plating B—Duplex .000010 [0.000254] gold on contact area, .000150-.000300 [0.00381-0.00762] tin-lead on solder area all over .000050 [0.00127] nickel

Plating C— .000100-.000200 [0.00254-0.00508] tin-lead over .000050 [0.00127]

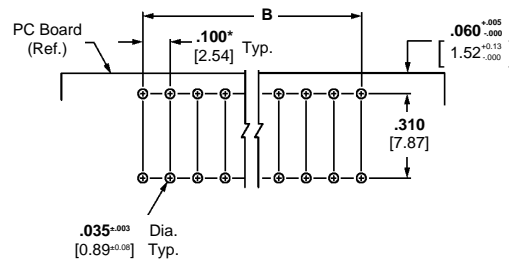
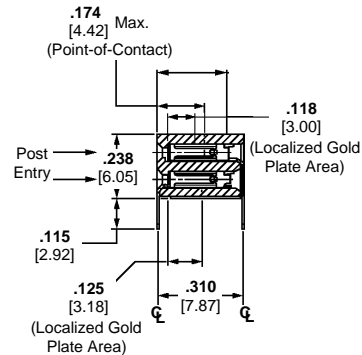
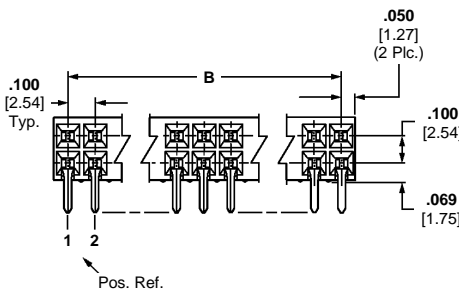

**Recommended PC Board Hole Layout
(for .062 [1.57] thick PC board)**

*±.003 [±0.08] tolerances not to accumulate within one connector pattern.

Related Product Data:

Mateable Headers—Refer to the Mating Post Selection Guide (page 89)

Performance Characteristics—page 185

Technical Documents (page 294):

Product Specification 108-25026

Application Specification 114-25018

Additional receptacle assembly sizes are available; minimum order quantities may apply. Consult Tyco Electronics.

No. of Pos.	Dimensions		Contact Plating/Part Nos.		
	A	B	Plating A	Plating B	Plating C
4	.200 [5.08]	.100 [2.54]	6-535512-1	146140-1	6-102084-4
6	.300 [7.62]	.200 [5.08]	6-535512-2	146140-2	6-102084-3
8	.400 [10.16]	.300 [7.62]	6-535512-3	146140-3	6-102084-2
10	.500 [12.70]	.400 [10.16]	6-535512-4	146140-4	6-102084-1
12	.600 [15.24]	.500 [12.70]	535512-1	146140-5	6-102084-0
14	.700 [17.78]	.600 [15.24]	1-535512-7	146140-6	5-102084-9
16	.800 [20.32]	.700 [17.78]	1-535512-8	146140-7	5-102084-8
18	.900 [22.86]	.800 [20.32]	1-535512-6	146140-8	5-102084-7
20	1.000 [25.40]	.900 [22.86]	535512-2	146140-9	5-102084-6
22	1.100 [27.94]	1.000 [25.40]	1-535512-9	1-146140-0	5-102084-5
24	1.200 [30.48]	1.100 [27.94]	535512-3	1-146140-1	5-102084-4
26	1.300 [33.02]	1.200 [30.48]	2-535512-0	1-146140-2	5-102084-3
28	1.400 [35.56]	1.300 [33.02]	2-535512-1	1-146140-3	5-102084-2
30	1.500 [38.10]	1.400 [35.56]	2-535512-2	1-146140-4	5-102084-1
32	1.600 [40.64]	1.500 [38.10]	2-535512-3	1-146140-5	5-102084-0
34	1.700 [43.18]	1.600 [40.64]	535512-4	1-146140-6	4-102084-9
36	1.800 [45.72]	1.700 [43.18]	535512-5	1-146140-7	4-102084-8
38	1.900 [48.26]	1.800 [45.72]	2-535512-4	1-146140-8	4-102084-7
40	2.000 [50.80]	1.900 [48.26]	2-535512-5	1-146140-9	4-102084-6
50	2.500 [63.50]	2.400 [60.96]	535512-7	2-146140-0	4-102084-1
60	3.000 [76.20]	2.900 [73.66]	3-535512-0	2-146140-1	3-102084-6

Notes: 1. Tyco Electronics recommends mating gold or duplex plated headers with duplex plated receptacle assemblies.
2. .256 [6.50] minimum positive pin stop to prevent shorting between row.

**Mod II Surface Mount Horizontal Receptacle Assemblies, .100 x .100
[2.54 x 2.54] Centerline**

Product Facts

- Surface mount leads
- All receptacle assemblies are end stackable
- Contact design employs dual cantilever beams with built-in anti-overstress feature
- Closed entry housings help prevent post stubbing
- Housings made of high temperature, surface mount compatible thermoplastic material, 94 V-0 rated
- Duplex gold and bright tin-lead plated contacts have full nickel underplate
- Housings feature PC board standoffs
- Recognized under the Component Program of Underwriters Laboratories Inc., File No. E28476
- Certified by Canadian Standards Association, File No. LR 7189

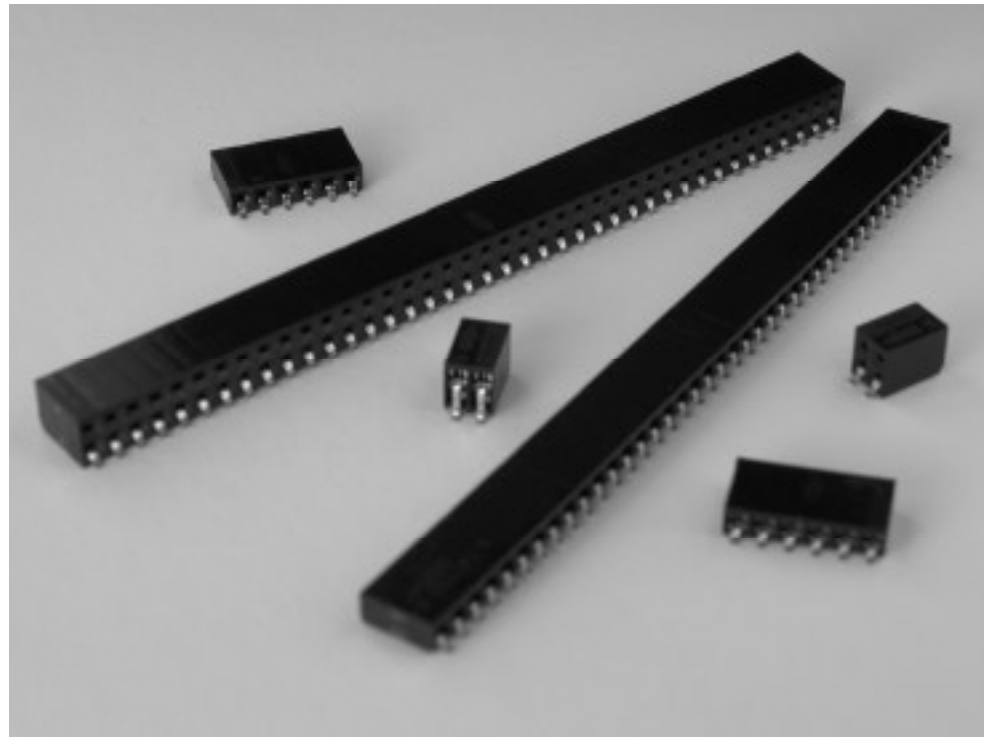

Horizontal surface mount receptacle assemblies are designed to reliably and economically meet the packaging and interconnection requirements of today's electronic industry as process technologies evolve from wave soldering to surface mount processing.

This broad product line is offered in both single and

double row configurations. The .100 [2.54] centerline assemblies are available in 2-40 (single row) positions and 4-80 (double row) positions. Housings are end stackable, which gives the advantage of added flexibility.

The housings are made of high temperature material that is 94 V-0 rated. Contacts are phosphor bronze, fully underplated

with nickel to help prevent corrosion and are available in three plating options.

The receptacle contact is an established proven design, with a fully enclosed one-piece "box" to protect the contact beams with built-in anti-overstress feature.

Performance Characteristics

Mechanical Characteristics:

Mating Force—6.0 oz. [1.67N] per contact (max.)

Unmating Force—.75 oz. [0.21N] per contact (min.) during third mating cycle

Durability—200 cycles

Environmental Characteristics:

Operating Temperature—
-55°C to +125°C

Electrical Characteristics:

Current Rating—3.0 amperes (max.) for single contact; 2.0 amperes (max.) per contact when connector is fully energized

Contact Resistance—12 milliohms (max.)

Insulation Resistance—5000 megohms (min.) between adjacent contacts

Dielectric Withstanding Voltage (at sea level)—750 V rms

Mod II Receptacle Assemblies, Single-Row, Surface Mount.100 [2.54] Centerline

Closed Entry, End Stackable, Short Point-of-Contact, with Standoffs



Material and Finish:

Housing—Black thermoplastic, 94V-0 rated, high temperature, surface mount compatible

Contacts—Phosphor bronze, plated as follows:

Plating A—Duplex .000030 [0.00076] gold on contact area, .000150-.000300 [0.00381-0.00762] tin-lead on solder area all over .000050 [0.00127] nickel

Plating B—Duplex .000010 [0.000254] gold on contact area, .000150-.000300 [0.00381-0.00762] tin-lead on solder area all over .000050 [0.00127] nickel

Plating C—.000100-.000200 [0.00254-0.00508] tin-lead over .000050 [0.00127] nickel

Related Product Data:

Mateable Headers—Refer to the Mating Post Selection Guide (page 89)

Performance Characteristics—page 188

Technical Documents (page 294):

Product Specification 108-25026

Application Specification 114-25018

Additional receptacle assembly sizes are available; minimum order quantities may apply. Consult Tyco Electronics.

Keying Plug

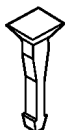

Part No. 86286-1
(Plugs into receptacle contact)

Material—Natural color nylon

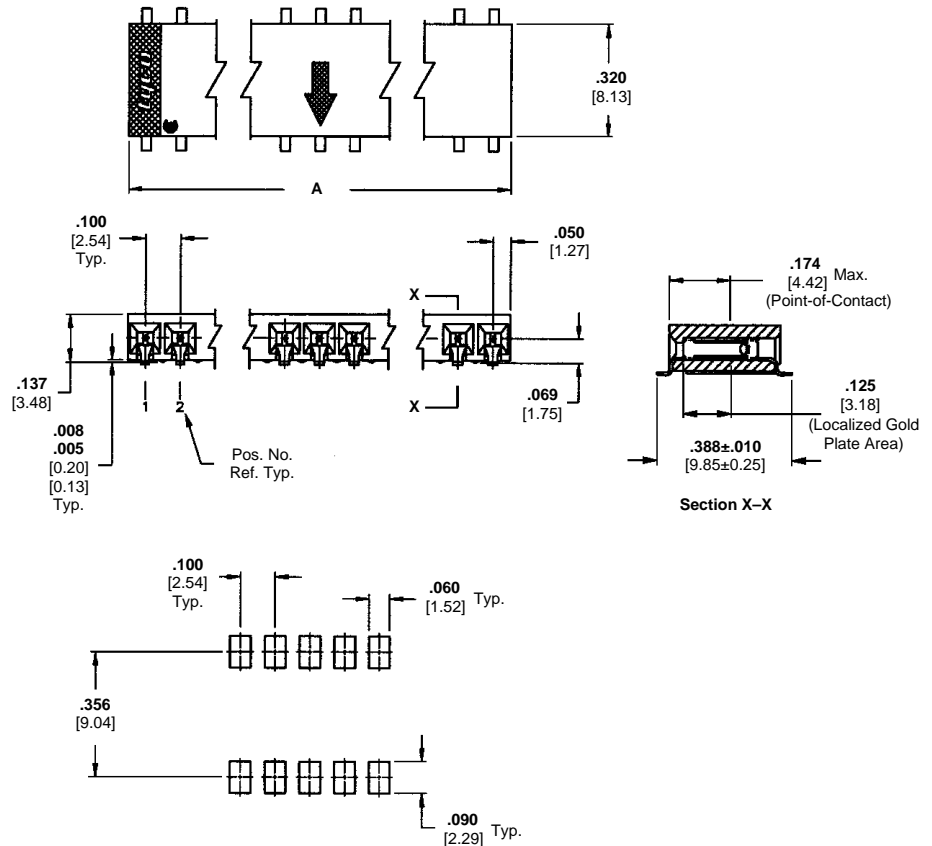

Recommended Etched Circuit Layout
(for .040 [1.02] min. thick PC Board;
.008 [0.20] thick stencil)

No. of Pos.	Dimensions A	Contact Plating/Part Nos.		
		Plating A	Plating B	Plating C
2	.200 [5.08]	147721-1	147732-1	147733-1
3	.300 [7.62]	147721-2	147732-2	147733-2
4	.400 [10.16]	147721-3	147732-3	147733-3
5	.500 [12.70]	147721-4	147732-4	147733-4
6	.600 [15.24]	147721-5	147732-5	147733-5
7	.700 [17.78]	147721-6	147732-6	147733-6
8	.800 [20.32]	147721-7	147732-7	147733-7
9	.900 [22.86]	147721-8	147732-8	147733-8
10	1.000 [25.40]	147721-9	147732-9	147733-9
11	1.100 [27.94]	1-147721-0	1-147732-0	1-147733-0
12	1.200 [30.48]	1-147721-1	1-147732-1	1-147733-1
13	1.300 [33.02]	1-147721-2	1-147732-2	1-147733-2
14	1.400 [35.56]	1-147721-3	1-147732-3	1-147733-3
15	1.500 [38.10]	1-147721-4	1-147732-4	1-147733-4
16	1.600 [40.64]	1-147721-5	1-147732-5	1-147733-5
17	1.700 [43.18]	1-147721-6	1-147732-6	1-147733-6
18	1.800 [45.72]	1-147721-7	1-147732-7	1-147733-7
19	1.900 [48.26]	1-147721-8	1-147732-8	1-147733-8
20	2.000 [50.80]	1-147721-9	1-147732-9	1-147733-9
30	3.000 [76.20]	2-147721-9	2-147732-9	2-147733-9
40	4.000 [101.60]	3-147721-9	3-147732-9	3-147733-9

Mod II Receptacle Assemblies, Double-Row, Surface Mount.100 [2.54] Centerline

Closed Entry, End Stackable, Short Point-of-Contact, with Standoffs



Material and Finish:

Housing—Black thermoplastic, 94V-0 rated, high temperature, surface mount compatible

Contacts—Phosphor bronze, plated as follows:

Plating A—Duplex .000030 [0.00076] gold on contact area, .000150-.000300 [0.00381-0.00762] tin-lead on solder area all over .000050 [0.00127] nickel

Plating B—Duplex .000010 [0.000254] gold on contact area, .000150-.000300 [0.00381-0.00762] tin-lead on solder area all over .000050 [0.00127] nickel

Plating C—.000100-.000200 [0.00254-0.00508] tin-lead over .000050 [0.00127]

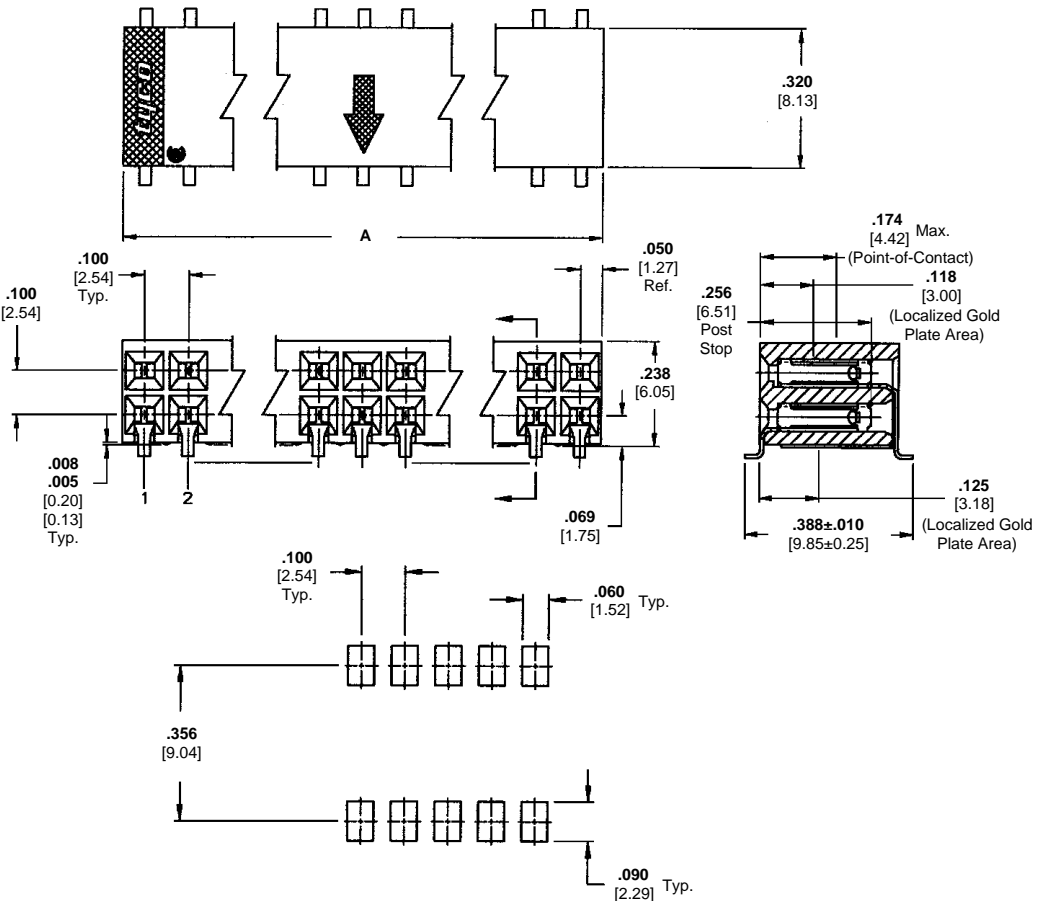

Recommended Etched Circuit Layout
(for .040 [1.02] min thick PC Board;
.008 [0.20] thick stencil)

Related Product Data:

Mateable Headers—Refer to the Mating Post Selection Guide (page 89)

Performance Characteristics—page 188

Technical Documents (page 294):

Product Specification 108-25026

Application Specification 114-25018

Additional receptacle assembly sizes are available; minimum order quantities may apply. Consult Tyco Electronics.

No. of Pos.	Dimensions A	Contact Plating/Part Nos.		
		Plating A	Plating B	Plating C
4	.200 [5.08]	147722-1	147734-1	147735-1
6	.300 [7.62]	147722-2	147734-2	147735-2
8	.400 [10.16]	147722-3	147734-3	147735-3
10	.500 [12.70]	147722-4	147734-4	147735-4
12	.600 [15.24]	147722-5	147734-5	147735-5
14	.700 [17.78]	147722-6	147734-6	147735-6
16	.800 [20.32]	147722-7	147734-7	147735-7
18	.900 [22.86]	147722-8	147734-8	147735-8
20	1.000 [25.40]	147722-9	147734-9	147735-9
22	1.100 [27.94]	1-147722-0	1-147734-0	1-147735-0
24	1.200 [30.48]	1-147722-1	1-147734-1	1-147735-1
26	1.300 [33.02]	1-147722-2	1-147734-2	1-147735-2
28	1.400 [35.56]	1-147722-3	1-147734-3	1-147735-3
30	1.500 [38.10]	1-147722-4	1-147734-4	1-147735-4
32	1.600 [40.64]	1-147722-5	1-147734-5	1-147735-5
34	1.700 [43.18]	1-147722-6	1-147734-6	1-147735-6
36	1.800 [45.72]	1-147722-7	1-147734-7	1-147735-7
38	1.900 [48.26]	1-147722-8	1-147734-8	1-147735-8
40	2.000 [50.80]	1-147722-9	1-147734-9	1-147735-9
50	2.500 [63.50]	2-147722-4	2-147734-4	2-147735-4
60	3.000 [76.20]	2-147722-9	2-147734-9	2-147735-9

Horizontal Mount, Receptacle Assemblies

5

Receptacle Assemblies, Vertical Mount

Product Facts

- Dual-cantilever beam contact with box design
- Single-row assemblies have .100 [2.54] centerline contact spacing; double-row assemblies have .100 x .100 [2.54 x 2.54] centerline contact spacing
- 3 through 40 positions in single-row assemblies; 2 through 80 positions in double-row assemblies
- Mod II Standard .340 [8.64] and Mod IV low .265 [6.73] profiles
- Mod II and Mod IV profiles available in dual entry
- Duplex gold and bright tin-lead plated contacts have full nickel underplate
- Thermoplastic housings, 94V-0 rated
- Standoffs for easy flux cleaning
- All throughhole assemblies are end stackable
- Recognized under the Component Program of Underwriters Laboratories Inc., File No. E28476
- Certified by Canadian Standards Association, File No. LR 7189

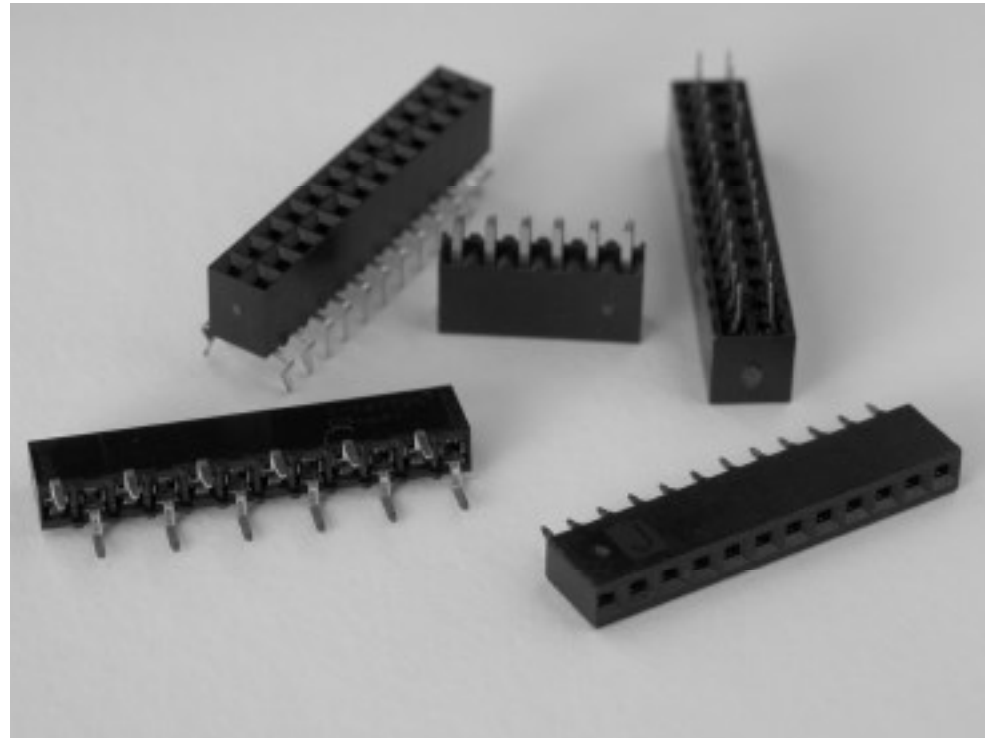

Vertical receptacle assemblies are designed to reliably and economically meet the packaging and interconnection requirements of today's electronic industry.

This broad product line offers a wide variety of assembly styles and features. They are available in dual entry style, in both single and double row configurations. The .100 [2.54] centerline assemblies are available in

3-40 (single row) positions and 2-80 (double row) positions. Standard and low profile housings which are end stackable also enhance the product line giving the advantage of added flexibility.

The housings are made of flame retardant material that is 94 V-0 rated. Contacts are phosphor bronze, fully underplated with nickel to help prevent corrosion and are available in three plating options.

The receptacle contact is an established proven design, with a fully enclosed one-piece "box" to protect the contact beams.

These assemblies are offered in .265 [6.73] (Mod IV) and .340[8.64] (Mod II) high profiles. Standard solder tails accommodate board thickness of .062 [1.57].

Product styles include single and dual tine variations. Outrigger tine styles are also available for bottom entry parallel board stacking applications.

Performance Characteristics

Mechanical Characteristics:

- Mating Force**—8.0 oz. [2.22N] per contact (max.)
- Unmating Force**—.75 oz. [0.28N] per contact (min.)
- Durability (Tested to)**—200 cycles

Environmental Characteristics:

- Operating Temperature**—-65°C to +105°C

Electrical Characteristics:

- Current Rating**—3.0 amperes (max.) for single contact; 2.0 amperes (max.) per contact when connector is fully energized
- Contact Resistance**—12 milliohms (max.)
- Insulation Resistance**—5000 megohms (min.) between adjacent contacts
- Dielectric Withstanding Voltage (at sea level)**—750 V rms

**Mod II Receptacle Assemblies, Single-Row,
.100 [2.54] Centerline**

**Closed Top Entry,
End Stackable, with
Single Tine Contacts**

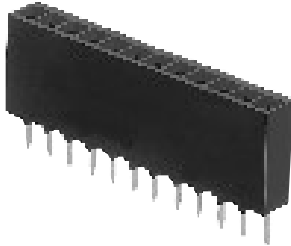

Material and Finish:

Housing—Black thermoplastic, 94V-0 rated

Contacts—Phosphor bronze, plated as follows:

Plating A—Duplex .000030 [0.00076] gold on contact area, .000150-.000300 [0.00381-0.00762] tin-lead on solder area all over .000050 [0.00127] nickel

Plating B—Duplex .000010 [0.000254] gold on contact area, .000150-.000300 [0.00381-0.00762] tin-lead on solder area all over .000050 [0.00127] nickel

Plating C—.000100-.000200 [0.00254-0.00508] tin-lead over .000050 [0.00127] nickel

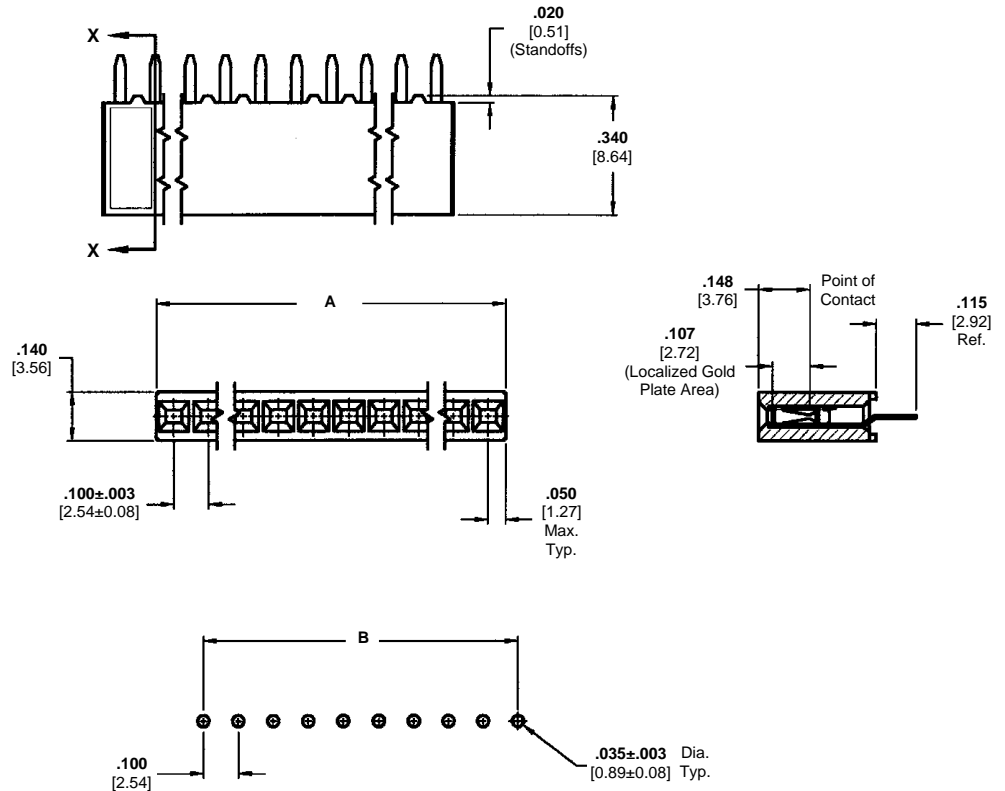

Recommended PC Board Hole Layout

Related Product Data:

Mateable Headers—Refer to the Mating Post Selection Guide (page 89)

Performance Characteristics—page 191

Technical Documents (page 294):

Product Specification 108-25022

Application Specification 114-25018

Additional receptacle assembly sizes are available; minimum order quantities may apply. Consult Tyco Electronics.

No. of Pos.	Dimensions		Contact Plating/Part Nos.		
	A	B	Plating A	Plating B	Plating C
3	.300 [7.62]	.200 [5.08]	534237-1	146386-1	146763-5
4	.400 [10.16]	.300 [7.62]	534237-2	1-146386-9	146763-6
5	.500 [12.70]	.400 [10.16]	534237-3	146386-2	146763-7
6	.600 [15.24]	.500 [12.70]	534237-4	146386-3	146763-8
7	.700 [17.78]	.600 [15.24]	534237-5	146386-4	146763-1
8	.800 [20.32]	.700 [17.78]	534237-6	146386-5	146763-2
9	.900 [22.86]	.800 [20.32]	534237-7	146386-6	146763-9
10	1.000 [25.40]	.900 [22.86]	534237-8	146386-7	146763-3
11	1.100 [27.94]	1.000 [25.40]	534237-9	146386-8	1-146763-0
12	1.200 [30.48]	1.100 [27.94]	1-534237-0	146386-9	1-146763-1
13	1.300 [33.02]	1.200 [30.48]	1-534237-1	1-146386-0	1-146763-2
14	1.400 [35.56]	1.300 [33.02]	1-534237-2	1-146386-1	1-146763-3
15	1.500 [38.10]	1.400 [35.56]	1-534237-3	2-146386-0	1-146763-4
16	1.600 [40.64]	1.500 [38.10]	1-534237-4	2-146386-1	1-146763-5
17	1.700 [43.18]	1.600 [40.64]	1-534237-5	2-146386-2	1-146763-6
18	1.800 [45.72]	1.700 [43.18]	1-534237-6	2-146386-3	1-146763-7
19	1.900 [48.26]	1.800 [45.72]	1-534237-7	2-146386-4	1-146763-8
20	2.000 [50.80]	1.900 [48.26]	1-534237-8	1-146386-2	1-146763-9
30	3.000 [76.20]	2.900 [73.66]	2-534237-8	1-146386-8	2-146763-8
40	4.000 [101.60]	3.900 [99.06]	3-534237-8	3-146386-8	3-146763-8

- Notes:**
1. Tyco Electronics recommends mating gold or duplex plated headers with duplex plated receptacle assemblies.
 2. To obtain the minimum mating post length, add .020 [0.51] (not including the post lead in chamfer) to the maximum point-of-contact dimension.

Keying Plug



Part No. 86286-1

(Plugs into receptacle contact)

Material—Natural color nylon

Vertical Mount, Receptacle Assemblies

5

**Mod II Receptacle Assemblies, Double-Row,
.100 x .100 [2.54 x 2.54] Centerline**

**Closed Top Entry,
Side and End Stackable
.100 x .100 [2.54 x 2.54]
Centerline, .100 [2.54]
Tine Spacing**



Material and Finish:

Housing—Black thermoplastic, 94V-0 rated

Contacts—Phosphor bronze, plated as follows:

Plating A—Duplex .00030 [0.00076] gold on contact area, .000150-.000300 [0.00381-0.00762] tin-lead on solder area all over .000050 [0.00127] nickel

Plating B—Duplex .00010 [0.000254] gold on contact area, .000150-.000300 [0.00381-0.00762] tin-lead on solder area all over .000050 [0.00127] nickel

Plating C— .000100-.000200 [0.00254-0.00508] tin-lead over .000050 [0.00127] nickel

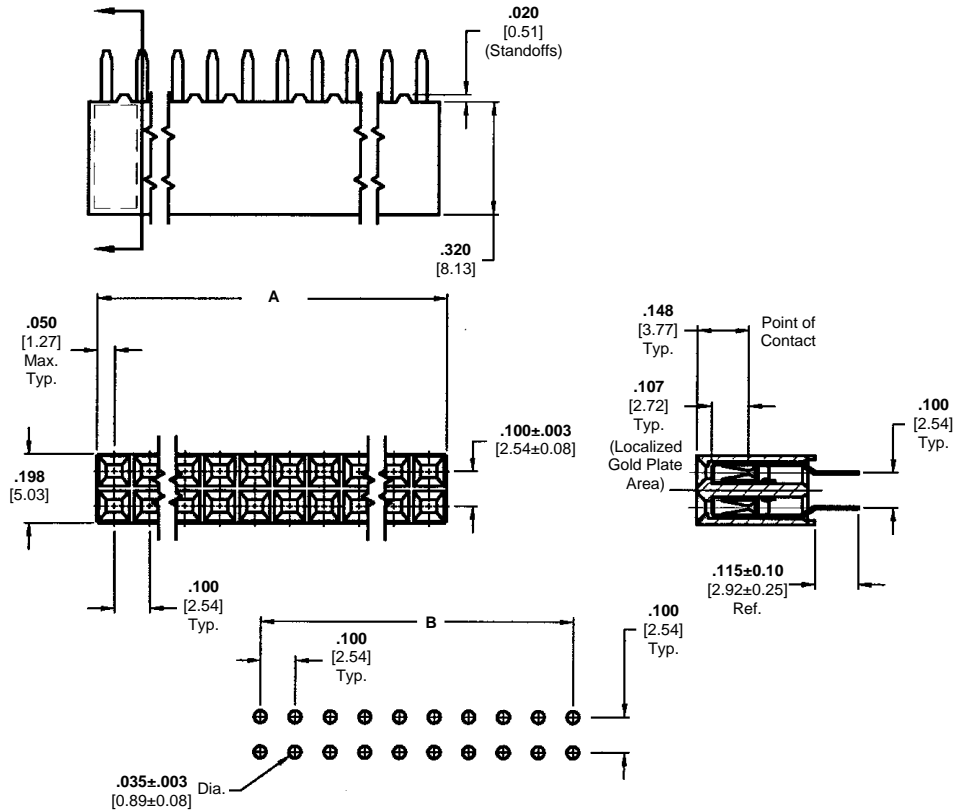

**Recommended PC Board Hole Layout
(for .062 [1.57] thick PC board)**

Related Product Data:

Mateable Headers—Refer to the Mating Post Selection Guide (page 89)

Performance Characteristics—page 191

Technical Documents (page 294):

Product Specification 108-25022

Application Specification 114-25018

Additional receptacle assembly sizes are available; minimum order quantities may apply. Consult Tyco Electronics.



Part No. 86286-1

(Plugs into receptacle contact)

Material—Natural color nylon

No. of Positions	Dimensions		Contact Plating/Part Nos.		
	A	B	Plating A	Plating B	Plating C
2	.100 [2.54]	—	534206-1	147424-1	146762-8
4	.200 [5.08]	.100 [2.54]	534206-2	147424-2	146762-9
6	.300 [7.62]	.200 [5.08]	534206-3	147424-3	1-146762-0
8	.400 [10.16]	.300 [7.62]	534206-4	147424-4	146762-1
10	.500 [12.70]	.400 [10.16]	534206-5	147424-5	146762-2
12	.600 [15.24]	.500 [12.70]	534206-6	147424-6	1-146762-1
14	.700 [17.78]	.600 [15.24]	534206-7	147424-7	1-146762-2
16	.800 [20.32]	.700 [17.78]	534206-8	147424-8	1-146762-3
18	.900 [22.86]	.800 [20.32]	534206-9	147424-9	146762-3
20	1.000 [25.40]	.900 [22.86]	1-534206-0	1-147424-0	146762-7
22	1.100 [27.94]	1.000 [25.40]	1-534206-1	1-147424-1	1-146762-4
24	1.200 [30.48]	1.100 [27.94]	1-534206-2	1-147424-2	1-146762-5
26	1.300 [33.02]	1.200 [30.48]	1-534206-3	1-147424-3	1-146762-6
28	1.400 [35.56]	1.300 [33.02]	1-534206-4	1-147424-4	1-146762-7
30	1.500 [38.10]	1.400 [35.56]	1-534206-5	1-147424-5	146762-4
32	1.600 [40.64]	1.500 [38.10]	1-534206-6	1-147424-6	1-146762-8
34	1.700 [43.18]	1.600 [40.64]	1-534206-7	1-147424-7	1-146762-9
36	1.800 [45.72]	1.700 [43.18]	1-534206-8	1-147424-8	2-146762-0
38	1.900 [48.26]	1.800 [45.72]	1-534206-9	1-147424-9	2-146762-1
40	2.000 [50.80]	1.900 [48.26]	2-534206-0	2-147424-0	146762-5

- Notes:** 1. Tyco Electronics recommends mating gold or duplex plated headers with duplex plated receptacle assemblies.
2. To obtain the minimum mating post length, add .020 [0.51] (not including the post lead in chamfer) to the maximum point-of-contact dimension.

Mod IV Receptacle Assemblies, Single-Row, .100 [2.54] Centerline

Bottom Entry, End Stackable, Low Profile with Dual Tine Contacts

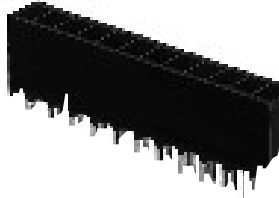

Material and Finish:

Housing—Black thermoplastic, 94V-0 rated

Contacts—Phosphor bronze, plated as follows:

Plating A—Duplex .000030 [0.00076] gold on contact area, .000050-.000100 [0.00127-0.00254] tin-lead on solder area all over .000050 [0.00127] nickel

Plating B—Duplex .000015 [0.000381] gold on contact area, .000050-.000100 [0.00127-0.00254] tin-lead on solder area all over .000050 [0.00127] nickel

Plating C—.000100-.000200 [0.00254-0.00508] tin-lead over .000050 [0.00127] nickel

Related Product Data:

Mateable Headers—Refer to the Mating Post Selection Guide (page 89)

Performance Characteristics—page 191

Technical Documents (page 294):

Product Specification 108-25022

Application Specification 114-25018

Additional receptacle assembly sizes are available; minimum order quantities may apply. Consult Tyco Electronics.

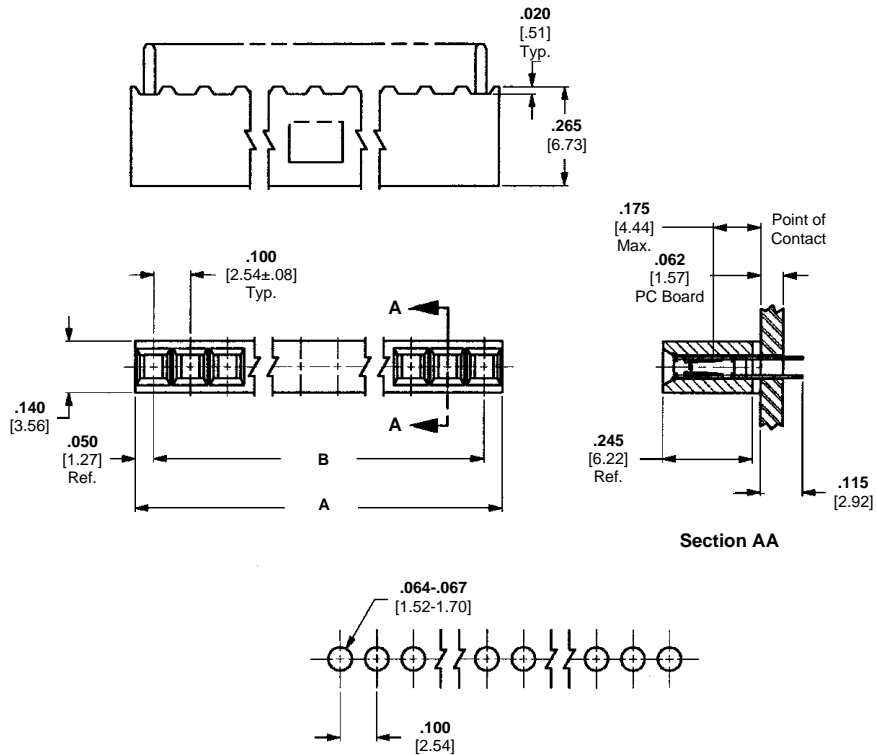

Recommended PC Board Hole Layout

No. of Positions	Dimensions		Contact Plating/Part Nos.		
	A	B	Plating A	Plating B	Plating C
3	.300 [7.62]	.200 [5.08]	3-87879-7	147326-1	102742-4
4	.400 [10.16]	.300 [7.62]	3-87879-6	147326-2	102742-8
5	.500 [12.70]	.400 [10.16]	3-87879-8	147326-3	102742-9
6	.600 [15.24]	.500 [12.70]	87879-3	147326-4	1-102742-0
7	.700 [17.78]	.600 [15.24]	87879-4	147326-5	102742-7
8	.800 [20.32]	.700 [17.78]	87879-1	147326-6	102742-3
9	.900 [22.86]	.800 [20.32]	87879-5	147326-7	102742-6
10	1.000 [25.40]	.900 [22.86]	87879-2	147326-8	1-102742-1
11	1.100 [27.94]	1.000 [25.40]	87879-6	147326-9	102742-1
12	1.200 [30.48]	1.100 [27.94]	87879-7	1-147326-0	102742-2
13	1.300 [33.02]	1.200 [30.48]	87879-8	1-147326-1	1-102742-2
14	1.400 [35.56]	1.300 [33.02]	87879-9	1-147326-2	1-102742-3
15	1.500 [38.10]	1.400 [35.56]	1-87879-0	1-147326-3	1-102742-4
16	1.600 [40.64]	1.500 [38.10]	1-87879-1	1-147326-4	102742-5
17	1.700 [43.18]	1.600 [40.64]	1-87879-2	1-147326-5	1-102742-5
18	1.800 [45.72]	1.700 [43.18]	1-87879-3	1-147326-6	1-102742-6
19	1.900 [48.26]	1.800 [45.72]	1-87879-4	1-147326-7	1-102742-7
20	2.000 [50.80]	1.900 [48.26]	1-87879-5	1-147326-8	1-102742-8
30	3.000 [76.20]	2.900 [73.66]	2-87879-5	2-147326-8	2-102742-8
40	4.000 [101.60]	3.900 [99.06]	3-87879-5	3-147326-8	3-102742-8

Notes: 1. Tyco Electronics recommends mating gold or duplex plated headers with duplex plated receptacle assemblies.
2. To obtain the minimum mating post length, add .020 [0.51] (not including the post lead in chamfer) to the maximum point-of-contact dimension and .062 for recommended board thickness.

Material—Natural color nylon

Catalog 1307819
Revised 6-04

www.tycoelectronics.com

Dimensions are in inches and millimeters unless otherwise specified. Values in brackets are metric equivalents.

Dimensions are shown for reference purposes only. Specifications subject to change.

USA: 1-800-522-6752
Canada: 1-905-470-4425
Mexico: 01-800-733-8926
C. America: 52-55-5-729-0425

South America: 55-11-3611-1514
Hong Kong: 852-2735-1628
Japan: 81-44-844-8013
UK: 44-141-810-8967

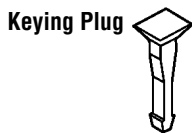

Part No. 86286-1

(Plugs into receptacle contact)

**Mod IV Receptacle Assemblies, Single-Row,
.100 [2.54] Centerline**

**Closed Top Entry,
End Stackable, Low Profile
with Single Tine Contacts**



Material and Finish:

Housing—Black thermoplastic, 94V-0 rated

Contacts—Phosphor bronze, plated as follows:

Plating A—Duplex .000030 [0.00076] gold on contact area, .000150-.000300 [0.00381-0.00762] tin-lead on solder area all over .000050 [0.00127] nickel

Plating B—Duplex .000010 [0.000254] gold on contact area, .000150-.000300 [0.00381-0.00762] tin-lead on solder area all over .000050 [0.00127] nickel

Plating C— .000100-.000200 [0.00254-0.00508] tin-lead over .000050 [0.00127] nickel

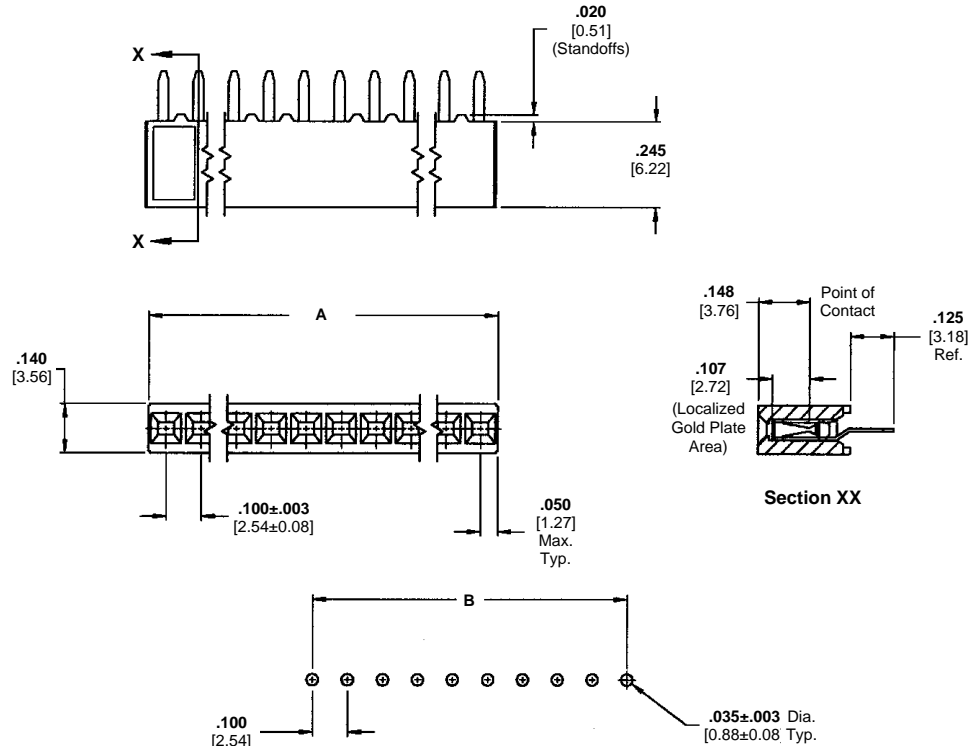

**Recommended PC Board Hole Layout
(for .062 [1.57] thick PCboard)**

Related Product Data:

Mateable Headers—Refer to the Mating Post Selection Guide (page 89)

Performance Characteristics—page 191

Technical Documents (page 294):

Product Specification 108-25022

Application Specification 114-25018

Additional receptacle assembly sizes are available; minimum order quantities may apply. Consult Tyco Electronics.

No. of Pos.	Dimensions		Contact Plating/Part Nos.		
	A	B	Plating A	Plating B	Plating C
3	.300 [7.62]	.200 [5.08]	535541-1	146138-1	535584-3
4	.400 [10.16]	.300 [7.62]	535541-2	146138-2	535584-4
5	.500 [12.70]	.400 [10.16]	535541-3	146138-3	535584-5
6	.600 [15.24]	.500 [12.70]	535541-4	146138-4	535584-1
7	.700 [17.78]	.600 [15.24]	535541-5	146138-5	535584-6
8	.800 [20.32]	.700 [17.78]	535541-6	146138-6	535584-7
9	.900 [22.86]	.800 [20.32]	535541-7	146138-7	535584-8
10	1.000 [25.40]	.900 [22.86]	535541-8	146138-8	535584-9
11	1.100 [27.94]	1.000 [25.40]	535541-9	146138-9	1-535584-0
12	1.200 [30.48]	1.100 [27.94]	1-535541-0	1-146138-0	1-535584-1
13	1.300 [33.02]	1.200 [30.48]	1-535541-1	1-146138-1	1-535584-2
14	1.400 [35.56]	1.300 [33.02]	1-535541-2	1-146138-2	1-535584-3
15	1.500 [38.10]	1.400 [35.56]	1-535541-3	1-146138-3	1-535584-4
16	1.600 [40.64]	1.500 [38.10]	1-535541-4	1-146138-4	1-535584-5
17	1.700 [43.18]	1.600 [40.64]	1-535541-5	1-146138-5	1-535584-6
18	1.800 [45.72]	1.700 [43.18]	1-535541-6	1-146138-6	535584-2
19	1.900 [48.26]	1.800 [45.72]	1-535541-7	1-146138-7	1-535584-7
20	2.000 [50.80]	1.900 [48.26]	1-535541-8	1-146138-8	1-535584-8
30	3.000 [76.20]	2.900 [73.66]	2-535541-8	1-146138-9	1-535584-9
40	4.000 [101.60]	3.900 [99.06]	3-535541-8	2-146138-0	2-535584-0

Notes: 1. Tyco Electronics recommends mating gold or duplex plated headers with select gold plated receptacle assemblies.
2. To obtain the minimum mating post length, add .020 [0.51] (not including the post lead in chamfer) to the maximum point-of-contact dimension.

**Mod IV Receptacle Assemblies, Double-Row,
.100 x .100 [2.54 x 2.54] Centerline**

**Closed Top Entry,
End and Side Stackable,
Low Profile, .100 x .100
[2.54 x 2.54] Centerline,
.100 [2.54] Tine Spacing**

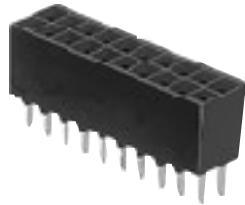

Material and Finish:

Housing—Black thermoplastic, 94V-0 rated

Contacts—Phosphor bronze, plated as follows:

Plating A—Duplex .000030 [0.00076] gold on contact area, .000150-.000300 [0.00381-0.00762] tin-lead on solder area all over .000050 [0.00127] nickel

Plating B—Duplex .000010 [0.000254] gold on contact area, .000150-.000300 [0.00381-0.00762] tin-lead on solder area all over .000050 [0.00127] nickel

Plating C—.000100-.000200 [0.00254-0.00508] tin-lead over .000050 [0.00127] nickel

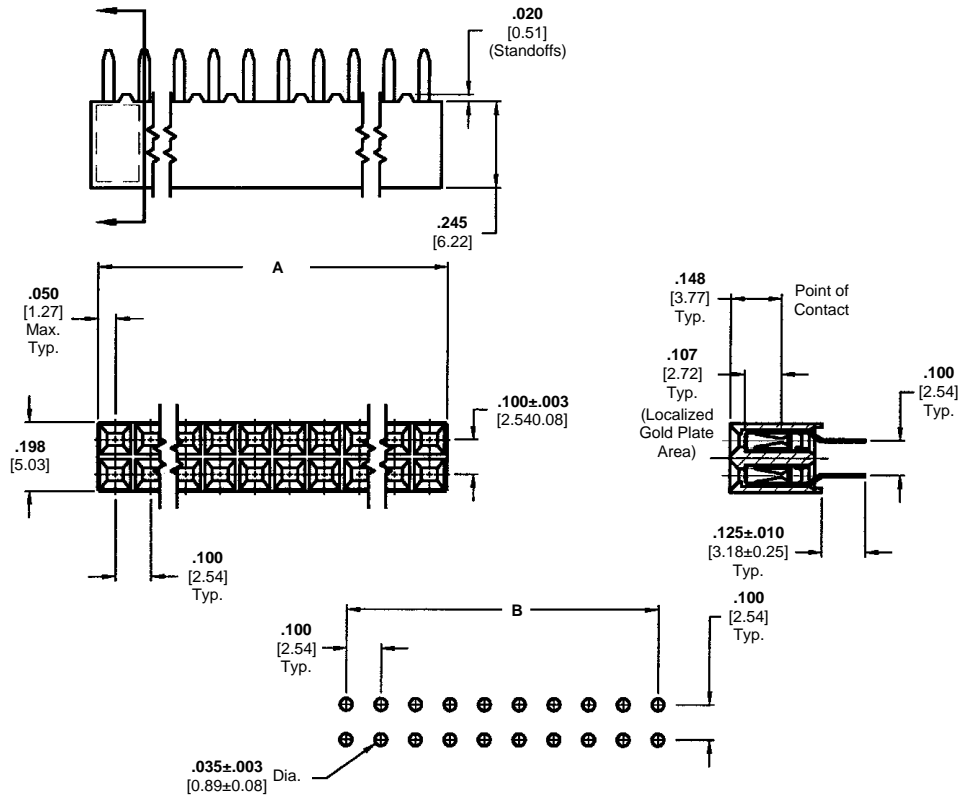

Recommended PC Board Hole Layout

Related Product Data:

Mateable Headers—Refer to the Mating Post Selection Guide (page 89)

Performance Characteristics—page 191

Technical Documents (page 294):

Product Specification 108-25022

Application Specification 114-25018

No. of Pos.	Dimensions		Contact Plating/Part Nos.		
	A	B	Plating A	Plating B	Plating C
2	.100 [2.54]	—	534998-1	535598-2	535585-3
4	.200 [5.08]	.100 [2.54]	534998-2	535598-3	535585-4
6	.300 [7.62]	.200 [5.08]	534998-3	535598-4	535585-5
8	.400 [10.16]	.300 [7.62]	534998-4	535598-5	535585-6
10	.500 [12.70]	.400 [10.16]	534998-5	535598-6	535585-1
12	.600 [15.24]	.500 [12.70]	534998-6	535598-7	535585-2
14	.700 [17.78]	.600 [15.24]	534998-7	535598-1	535585-7
16	.800 [20.32]	.700 [17.78]	534998-8	535598-8	535585-8
18	.900 [22.86]	.800 [20.32]	534998-9	535598-9	535585-9
20	1.000 [25.40]	.900 [22.86]	1-534998-0	1-535598-0	1-535585-0
22	1.100 [27.94]	1.000 [25.40]	1-534998-1	1-535598-1	1-535585-1
24	1.200 [30.48]	1.100 [27.94]	1-534998-2	1-535598-2	1-535585-2
26	1.300 [33.02]	1.200 [30.48]	1-534998-3	1-535598-3	1-535585-3
28	1.400 [35.56]	1.300 [33.02]	1-534998-4	1-535598-4	1-535585-4
30	1.500 [38.10]	1.400 [35.56]	1-534998-5	1-535598-5	1-535585-5
32	1.600 [40.64]	1.500 [38.10]	1-534998-6	1-535598-6	1-535585-6
34	1.700 [43.18]	1.600 [40.64]	1-534998-7	1-535598-7	1-535585-7
36	1.800 [45.72]	1.700 [43.18]	1-534998-8	1-535598-8	1-535585-8
38	1.900 [48.26]	1.800 [45.72]	1-534998-9	1-535598-9	1-535585-9
40	2.000 [50.80]	1.900 [48.26]	2-534998-0	2-535598-0	2-535585-0

- Notes:** 1. Tyco Electronics recommends mating gold or duplex plated headers with duplex plated receptacle assemblies.
2. To obtain the minimum mating post length, add .020 [0.51] (not including the post lead in chamfer) to the maximum point-of-contact dimension.

Vertical Mount, Receptacle Assemblies

5

**Mod IV Receptacle Assemblies, Double-Row,
.100 x .100 [2.54 x 2.54] Centerline** (Continued)

Keying Plug

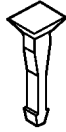

Part No. 86286-1
(Plugs into receptacle contact)

Material—Natural color nylon

No. of Pos.	Dimensions		Contact Plating/Part Nos.		
	A	B	Plating A	Plating B	Plating C
42	2.100 [53.34]	2.000 [50.80]	2-534998-1	2-535598-4	2-535585-4
44	2.200 [55.88]	2.100 [53.34]	2-534998-2	2-535598-5	2-535585-5
46	2.300 [58.42]	2.200 [55.88]	2-534998-3	2-535598-6	2-535585-6
48	2.400 [60.96]	2.300 [58.42]	2-534998-4	2-535598-7	2-535585-7
50	2.500 [63.50]	2.400 [60.96]	2-534998-5	2-535598-1	2-535585-1
52	2.600 [66.04]	2.500 [63.50]	2-534998-6	2-535598-8	2-535585-8
54	2.700 [68.58]	2.600 [66.04]	2-534998-7	2-535598-9	2-535585-9
56	2.800 [71.12]	2.700 [68.58]	2-534998-8	3-535598-0	3-535585-0
58	2.900 [73.66]	2.800 [71.12]	2-534998-9	3-535598-1	3-535585-1
60	3.000 [76.20]	2.900 [73.66]	3-534998-0	2-535598-2	2-535585-2
62	3.100 [78.74]	3.000 [76.20]	3-534998-1	3-535598-2	3-535585-2
64	3.200 [81.28]	3.100 [78.74]	3-534998-2	3-535598-3	3-535585-3
66	3.300 [83.82]	3.200 [81.28]	3-534998-3	3-535598-4	3-535585-4
68	3.400 [86.36]	3.300 [83.82]	3-534998-4	3-535598-5	3-535585-5
70	3.500 [88.90]	3.400 [86.36]	3-534998-5	3-535598-6	3-535585-6
72	3.600 [91.44]	3.500 [88.90]	3-534998-6	3-535598-7	3-535585-7
74	3.700 [93.98]	3.600 [91.44]	3-534998-7	3-535598-8	3-535585-8
76	3.800 [96.52]	3.700 [93.98]	3-534998-8	3-535598-9	3-535585-9
78	3.900 [99.06]	3.800 [96.52]	3-534998-9	4-535598-0	4-535585-0
80	4.000 [101.60]	3.900 [99.06]	4-534998-0	2-535598-3	2-535585-3

- Notes:** 1. Tyco Electronics recommends mating gold or duplex plated headers with duplex plated receptacle assemblies.
2. To obtain the minimum mating post length, add .020 [0.51] (not including the post lead in chamfer) to the maximum point-of-contact dimension.

**Mod IV Receptacle Assemblies, Single-Row, Outrigger Design
.100 x .100 [2.54 x 2.54] Centerline, End To End Stackable**

Dual Entry, End Stackable,
Low Profile, .100 x .100
[2.54 x 2.54] Centerline,
.200 [5.08] Tine Spacing

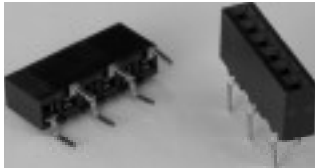

Material and Finish:

Plating A—Duplex .000030 [0.00076] gold on contact area, .000150-0.000300 [0.00381-0.00762] tin-lead on solder area all over .000050 [0.00127] nickel

Plating B—Duplex .000010 [0.000254] gold on contact area, .000150-.000300 [0.00381-0.00762] tin-lead on solder area all over .000050 [0.00127] nickel

Plating C— .000100-.000200 [0.00254-0.00508] tin-lead over .000050 [0.00127] nickel

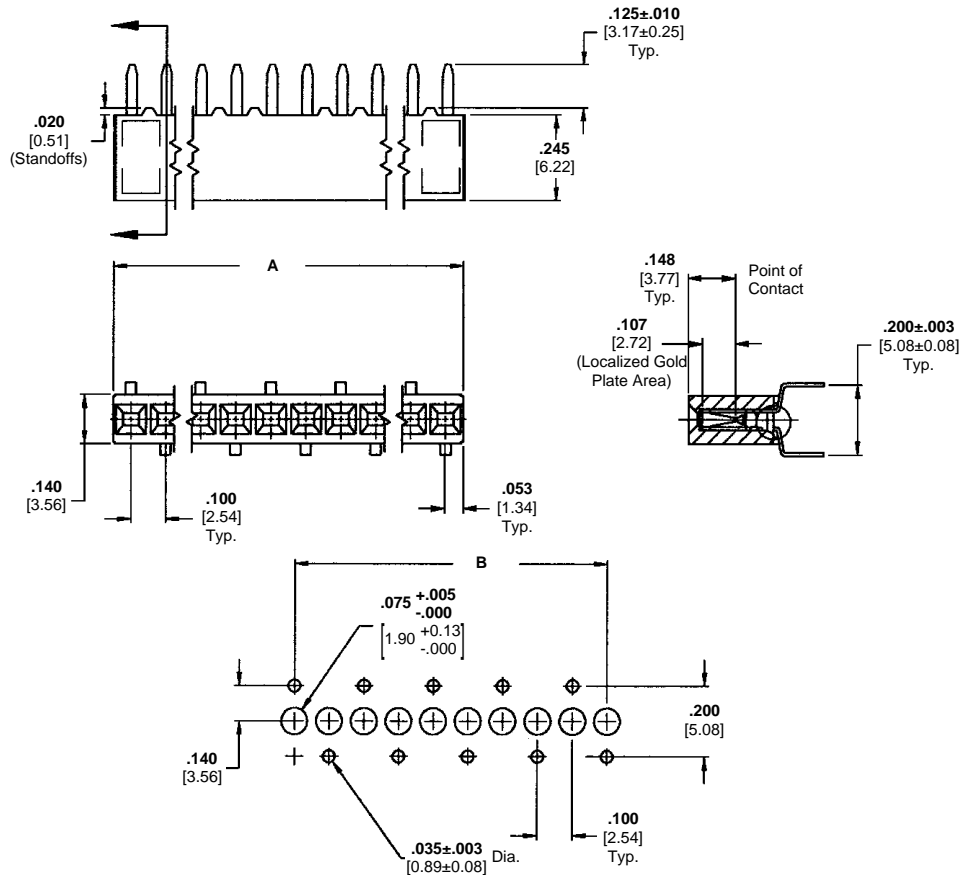

Recommended PC Board Hole Layout

No. of Pos.	Dimensions		Contact Plating/ Part Nos.		
	A	B	Plating A	Plating B	Plating C
3	.300 [7.62]	.200 [5.08]	147720-2	147726-2	147727-2
4	.400 [10.16]	.300 [7.62]	147720-3	147726-3	147727-3
5	.500 [12.70]	.400 [10.16]	147720-4	147726-4	147727-4
6	.600 [15.24]	.500 [12.70]	147720-5	147726-5	147727-5
7	.700 [17.78]	.600 [15.24]	147720-6	147726-6	147727-6
8	.800 [20.32]	.700 [17.78]	147720-7	147726-7	147727-7
9	.900 [22.86]	.800 [20.32]	147720-8	147726-8	147727-8
10	1.000 [25.40]	.900 [22.86]	147720-9	147726-9	147727-9
11	1.100 [27.94]	1.000 [25.40]	1-147720-0	1-147726-0	1-147727-0
12	1.200 [30.48]	1.100 [27.94]	1-147720-1	1-147726-1	1-147727-1
13	1.300 [33.02]	1.200 [30.48]	1-147720-2	1-147726-2	1-147727-2
14	1.400 [35.56]	1.300 [33.02]	1-147720-3	1-147726-3	1-147727-3
15	1.500 [38.10]	1.400 [35.56]	1-147720-4	1-147726-4	1-147727-4
16	1.600 [40.64]	1.500 [38.10]	1-147720-5	1-147726-5	1-147727-5
17	1.700 [43.18]	1.600 [40.64]	1-147720-6	1-147726-6	1-147727-6
18	1.800 [45.72]	1.700 [43.18]	1-147720-7	1-147726-7	1-147727-7
19	1.900 [48.26]	1.800 [45.72]	1-147720-8	1-147726-8	1-147727-8
20	2.000 [50.80]	1.900 [48.26]	1-147720-9	1-147726-9	1-147727-9
30	3.000 [76.20]	2.900 [73.66]	2-147720-9	2-147726-9	2-147727-9
40	4.000 [101.60]	3.900 [99.06]	3-147720-9	3-147726-9	3-147727-9

- Notes:** 1. Tyco Electronics recommends mating gold or duplex plated headers with duplex plated receptacle assemblies.
2. To obtain the minimum mating post length, add .020 [0.51] (not including the post lead in chamfer) to the maximum point-of-contact dimension and add .062 [1.57] for recommended board thickness if used in bottom entry application.

Vertical Mount, Receptacle Assemblies

5

Mod IV Receptacle Assemblies, Double-Row, Outrigger Design, .100 x .100 [2.54 x 2.54] Centerline, End to End Stackable

Dual Entry, End Stackable, Low Profile, .100 x .100 [2.54 x 2.54] Centerline, .300 [7.62] Tine Spacing

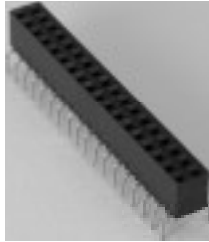

Material and Finish:

Housing—Black thermoplastic, 94V-0 rated

Contacts—Phosphor bronze, plated as follows:

Plating A—Duplex .000030 [0.00076] gold on contact area, .000150-.000300 [0.00381-0.00762] tin-lead on solder area all over .000050 [0.00127] nickel

Plating B—Duplex .000010 [0.000254] gold on contact area, .000150-.000300 [0.00381-0.00762] tin-lead on solder area all over .000050 [0.00127] nickel

Plating C—.000100-.000200 [0.00254-0.00508] tin-lead over .000050 [0.00127] nickel

Related Product Data:

Mateable Headers—Refer to the Mating Post Selection Guide (page 89)

Performance Characteristics—page 191

Technical Documents (page 294):

Product Specification 108-25022

Application Specification 114-25018

Additional receptacle assembly sizes are available; minimum order quantities may apply. Consult Tyco Electronics.

Keying Plug

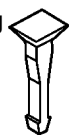

Part No. 86286-1
(Plugs into receptacle contact)

Material—Natural color nylon

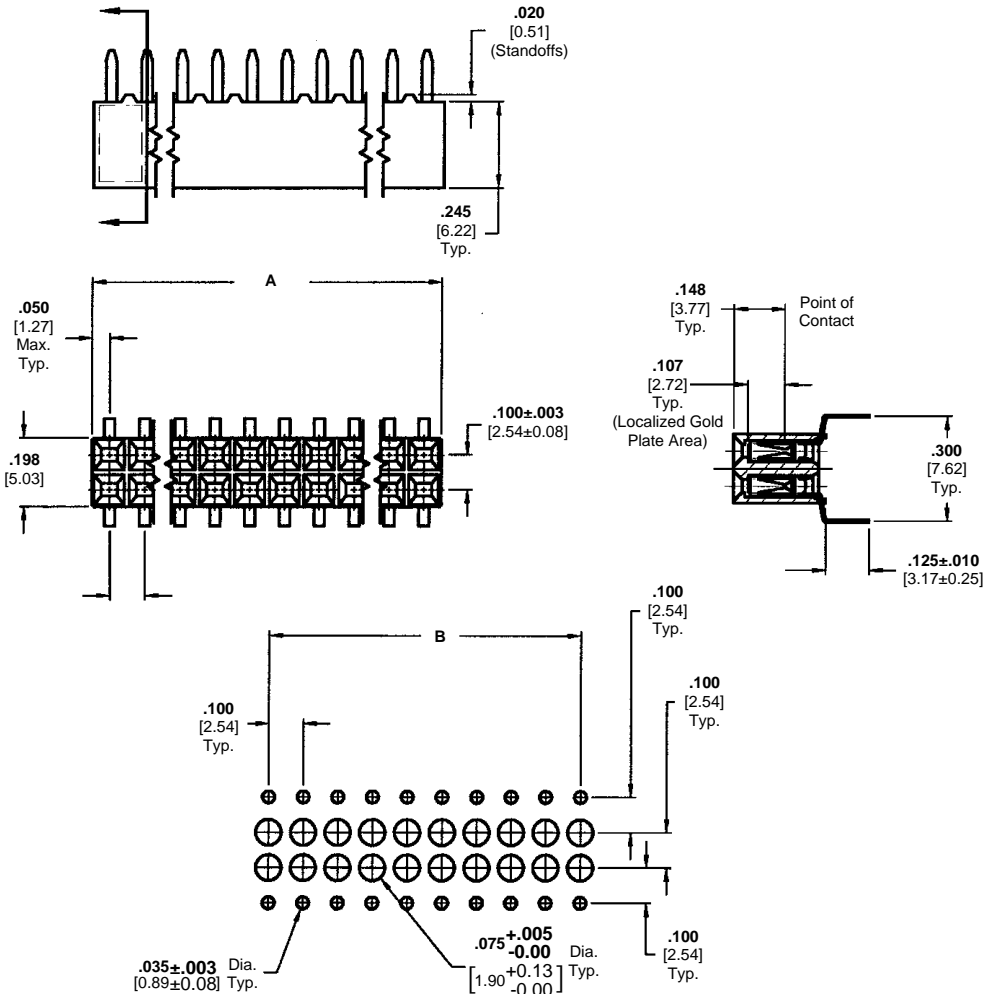

Recommended PC Board Hole Layout

No. of Positions	Dimensions		Contact Plating/Part Nos.		
	A	B	Plating A	Plating B	Plating C
2	.100 [2.54]	—	1-534267-3	147099-1	3-147100-9
4	.200 [5.08]	.100 [2.54]	1-534267-7	147099-2	4-147100-0
6	.300 [7.62]	.200 [5.08]	1-534267-4	147099-3	147100-1
8	.400 [10.16]	.300 [7.62]	534267-5	147099-4	147100-2
14	.700 [17.78]	.600 [15.24]	534267-1	147099-7	147100-5
18	.900 [22.86]	.800 [20.32]	1-534267-0	147099-9	147100-7
20	1.000 [25.40]	.900 [22.86]	534267-2	1-147099-0	147100-8
24	1.200 [30.48]	1.100 [27.94]	534267-9	1-147099-2	1-147100-0
30	1.500 [38.10]	1.400 [35.56]	1-534267-2	1-147099-5	1-147100-3
36	1.800 [45.72]	1.700 [43.18]	1-534267-5	1-147099-8	1-147100-6
40	2.000 [50.80]	1.900 [48.26]	534267-7	2-147099-0	1-147100-8
48	2.400 [60.96]	2.300 [58.42]	1-534267-1	2-147099-4	2-147100-2
50	2.500 [63.50]	2.400 [60.96]	1-534267-8	2-147099-5	2-147100-3
60	3.000 [76.20]	2.900 [73.66]	534267-8	3-147099-0	2-147100-8
76	3.800 [96.52]	3.700 [93.98]	1-534267-6	3-147099-8	3-147100-6
80	4.000 [101.60]	3.900 [99.06]	534267-4	4-147099-0	3-147100-8

- Notes:**
1. Tyco Electronics recommends mating gold or duplex plated headers with duplex plated receptacle assemblies.
 2. To obtain the minimum mating post length, add .020 [0.51] (not including the post lead in chamfer) to the maximum point-of-contact dimension and .062 for recommended board thickness if used in bottom entry application.

**Mod. IV Receptacle Assemblies, Double-Row,
.100 x .100 [2.54 x 2.54] Centerline**

Closed Dual Entry, Side and End Stackable Low Profile, .100 x .100 [2.54 x 2.54] Centerline, .150 [3.81] Tine Spacing

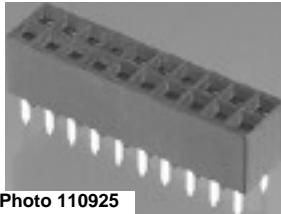

Photo 110925

Material and Finish:

Housing—Black thermoplastic, 94V-0 rated

Contacts—Phosphor bronze, plated as follows:

Plating A—Duplex .000030 [0.00076] gold on contact area, .000150-.000300 [0.00381-0.00762] tin-lead on solder area all over .000050 [0.00127] nickel

Plating B—Duplex .000010 [0.000254] gold on contact area, .000150-.000300 [0.00381-0.00762] tin-lead on solder area all over .000050 [0.00127] nickel

Plating C—.000100-.000200 [0.00254-0.00508] tin-lead over .000050 [0.00127] nickel

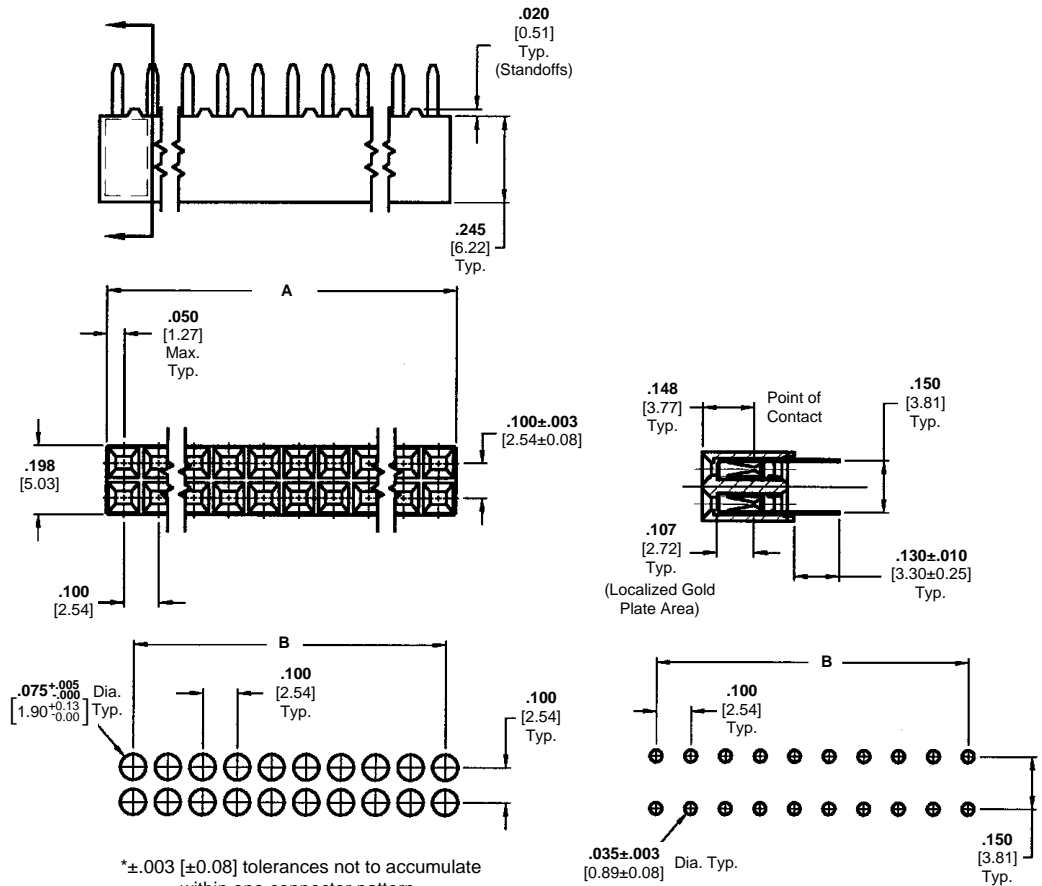

Recommended PC Board Hole Layout for Bottom Entry or Pass Through Applications

Recommended PC Board Hole Layout for Top Entry

Related Product Data:

Mateable Headers—Refer to the Mating Post Selection Guide (page 89)

Performance Characteristics—page 191

Technical Documents (page 294):

Product Specification 108-25022

Application Specification 114-25018

No. of Pos.	Dimensions		Contact Plating/Part Nos.		
	A	B	Plating A	Plating B	Plating C
2	.100 [2.54]	—	535542-1	147095-1	147096-1
4	.200 [5.08]	.100 [2.54]	535542-2	147095-2	147096-2
6	.300 [7.62]	.200 [5.08]	535542-3	147095-3	147096-3
8	.400 [10.16]	.300 [7.62]	535542-4	147095-4	147096-4
10	.500 [12.70]	.400 [10.16]	535542-5	147095-5	147096-5
12	.600 [15.24]	.500 [12.70]	535542-6	147095-6	147096-6
14	.700 [17.78]	.600 [15.24]	535542-7	147095-7	147096-7
16	.800 [20.32]	.700 [17.78]	535542-8	147095-8	147096-8
18	.900 [22.86]	.800 [20.32]	535542-9	147095-9	147096-9
20	1.000 [25.40]	.900 [22.86]	1-535542-0	1-147095-0	1-147096-0
22	1.100 [27.94]	1.000 [25.40]	1-535542-1	1-147095-1	1-147096-1
24	1.200 [30.48]	1.100 [27.94]	1-535542-2	1-147095-2	1-147096-2
26	1.300 [33.02]	1.200 [30.48]	1-535542-3	1-147095-3	1-147096-3
28	1.400 [35.56]	1.300 [33.02]	1-535542-4	1-147095-4	1-147096-4
30	1.500 [38.10]	1.400 [35.56]	1-535542-5	1-147095-5	1-147096-5
32	1.600 [40.64]	1.500 [38.10]	1-535542-6	1-147095-6	1-147096-6
34	1.700 [43.18]	1.600 [40.64]	1-535542-7	1-147095-7	1-147096-7
36	1.800 [45.72]	1.700 [43.18]	1-535542-8	1-147095-8	1-147096-8
38	1.900 [48.26]	1.800 [45.72]	1-535542-9	1-147095-9	1-147096-9
40	2.000 [50.80]	1.900 [48.26]	2-535542-0	2-147095-0	2-147096-0

- Notes:**
1. Tyco Electronics recommends mating gold or duplex plated headers with duplex plated receptacle assemblies.
 2. To obtain the minimum mating post length, add .020 [0.51] (not including the post lead in chamfer) to the maximum point-of-contact dimension, and .062 [1.57] for recommended board thickness if used in bottom entry application.

Vertical Mount, Receptacle Assemblies

5

**Mod. IV Receptacle Assemblies, Double-Row,
.100 x .100 [2.54 x 2.54] Centerline** (Continued)

No. of Pos.	Dimensions		Contact Plating/Part Nos.		
	A	B	Plating A	Plating B	Plating C
42	2.100 [53.34]	2.000 [50.80]	2-535542-1	2-147095-1	2-147096-1
44	2.200 [55.88]	2.100 [53.34]	2-535542-2	2-147095-2	2-147096-2
46	2.300 [58.42]	2.200 [55.88]	2-535542-3	2-147095-3	2-147096-3
48	2.400 [60.96]	2.300 [58.42]	2-535542-4	2-147095-4	2-147096-4
50	2.500 [63.50]	2.400 [60.96]	2-535542-5	2-147095-5	2-147096-5
52	2.600 [66.04]	2.500 [63.50]	2-535542-6	2-147095-6	2-147096-6
54	2.700 [68.58]	2.600 [66.04]	2-535542-7	2-147095-7	2-147096-7
56	2.800 [71.12]	2.700 [68.58]	2-535542-8	2-147095-8	2-147096-8
58	2.900 [73.66]	2.800 [71.12]	2-535542-9	2-147095-9	2-147096-9
60	3.000 [76.20]	2.900 [73.66]	3-535542-0	3-147095-0	3-147096-0
62	3.100 [78.74]	3.000 [76.20]	3-535542-1	3-147095-1	3-147096-1
64	3.200 [81.28]	3.100 [78.74]	3-535542-2	3-147095-2	3-147096-2
66	3.300 [83.82]	3.200 [81.28]	3-535542-3	3-147095-3	3-147096-3
68	3.400 [86.36]	3.300 [83.82]	3-535542-4	3-147095-4	3-147096-4
70	3.500 [88.90]	3.400 [86.36]	3-535542-5	3-147095-5	3-147096-5
72	3.600 [91.44]	3.500 [88.90]	3-535542-6	3-147095-6	3-147096-6
74	3.700 [93.98]	3.600 [91.44]	3-535542-7	3-147095-7	3-147096-7
76	3.800 [96.52]	3.700 [93.98]	3-535542-8	3-147095-8	3-147096-8
78	3.900 [99.06]	3.800 [96.52]	3-535542-9	3-147095-9	3-147096-9
80	4.000 [101.60]	3.900 [99.06]	4-535542-0	4-147095-0	4-147096-0

**Mod IV Surface-Mount Vertical Receptacle Assemblies,
.100 x .100 [2.54 x 2.54] Centerline**

Product Facts

- Surface Mount Leads
- Contact Material: phosphor bronze
- High temperature, black thermoplastic housings, 94V-0 rated, capable of withstanding IR or vapor-phase reflow
- Gold/tin-lead duplex plating for reliable mating interconnection and solder interface
- Metallic hold downs provide retention in the PC board prior to and during the reflow process . . . and strain relief after soldering
- Hold downs provide for proper lead-to-pad registration
- Closed-entry receptacle housings provide lead-in ramp for positive mating
- Receptacle contacts employ dual cantilever beams and built-in anti-overstress for reliable connections
- Recognized under the Component Program of Underwriters Laboratories Inc. File No. E28476
- Certified by Canadian Standards Association, File No. LR 7189

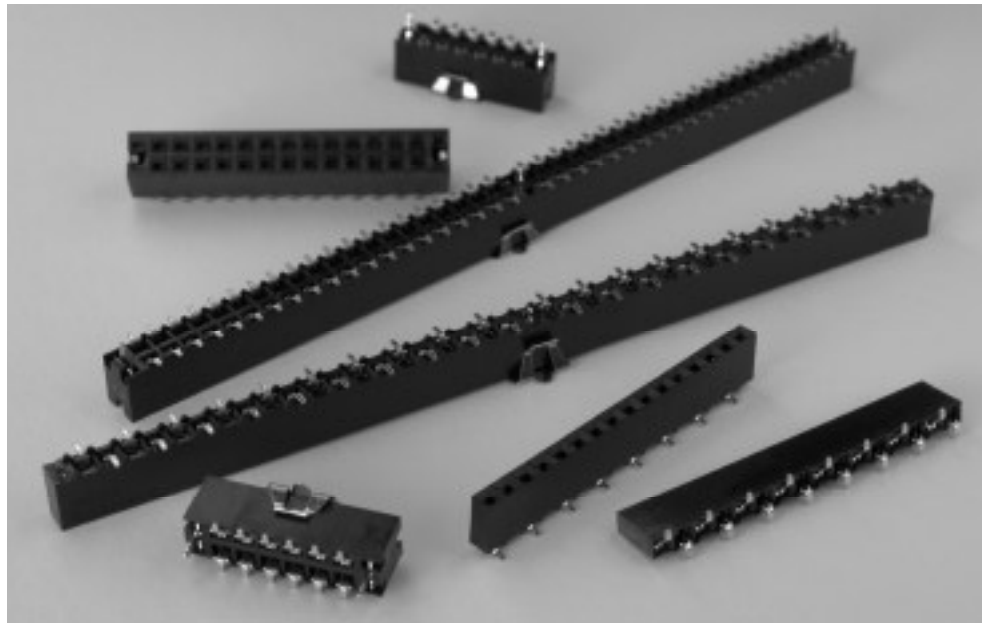

The AMPMODU 0.025 [0.64] square interconnection system is an industry standard that has provided level III and IV through-hole interconnections to almost every industry and marketplace for years. As technology advances, so has the AMPMODU product line.

Surface mount vertical receptacle assemblies are available to meet your level II packaging needs as process technologies evolve from wave soldering to surface-mount reflow (infrared and vapor-phase) processes. AMPMODU surface-mount receptacle assemblies are offered in vertical dual entry configurations. These receptacles are available in single-row and double-row configurations with a contact centerline spacing of .100 x .100 [2.54 x 2.54].

AMPMODU surface-mount vertical receptacle assemblies continue to provide the proven features and benefits of the through-hole counterparts in the AMPMODU product family. Closed-entry style housing design provides a lead-in ramp for positive mating of contacts, virtually eliminating the possibility of stubbing. The dual-beam receptacle contact design, coupled with gold plating in the contact area, provides a reliable interface. The contacts also provide built-in anti-overstress protection. Tin-lead plating on the solder tails also enhances solderability.

The incorporation of compliant metallic hold downs on receptacle assemblies offers multiple benefits. The hold downs provide for proper lead-to-pad registration and provide retention to the PC

board prior to and during processing. Used with a plated through-hole, the hold downs are soldered during the reflow process and serve as a strain relief for the solder joints during mating/unmating.

The design of the hold downs results in an excellent ratio of insertion/extraction forces (into the PC board); 20 lb. [89 N] maximum insertion force per pair and 10 lb. [44.5 N] minimum extraction force per pair (unsoldered). No tools are required for insertion.

**Mod IV Surface-Mount Vertical Receptacle Assemblies,
.100 x .100 [2.54 x 2.54] Centerline** (Continued)**Performance
Specifications****Voltage Rating:** 250 VAC**Current Rating:** 3.0 amperes (max.) for single contact;
2.0 amperes (max.) per contact when connector is fully energized**Operating Temperature Range (Receptacle Assemblies):** -65°C to +125°C**Operating Temperature Range (Headers):** -65°C to +105°C**Dielectric Withstanding Voltage:** 750 VAC**Termination Resistance:** 12 milliohms (max.)**Insulation Resistance:** 5000 megohms (min.)**Mating Force (Receptacle Assemblies):** 8.0 oz. [2.22N] (max.) per contact**Unmating Force (Receptacle Assemblies):** .75 oz. [0.21N] (min.) per contact**Durability:** Tested to 200 cycles (min.) for .000030 [0.00076] gold plated contacts

Mod IV Receptacle Assemblies, Single-Row, Surface Mount, .100 [2.54] Centerline with Compliant Pin Hold Downs

Surface Mount, Dual Entry with Compliant Pin Holddowns

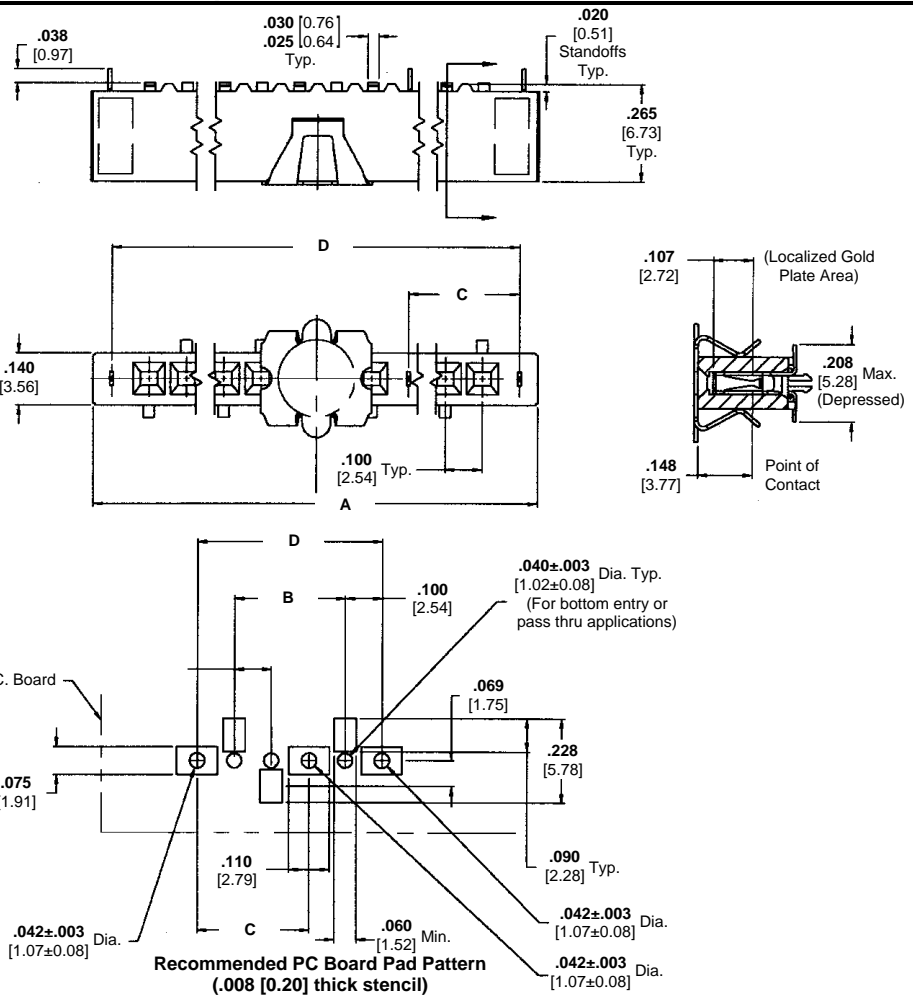

Material and Finish:

Plating A—Duplex .000030 [0.00076] gold on contact area, .000150-.000300 [0.00381-0.00762] tin-lead on solder area all over .000050 [0.00127] nickel

Plating B—Duplex .000010 [0.000254] gold on contact area, .000150-.000300 [0.00381-0.00762] tin-lead on solder area all over .000050 [0.00127] nickel

Plating C— .000100-.000200 [0.00254-0.00508] tin-lead over .000050 [0.00127] nickel

Related Product Data:

Mateable Headers—Refer to Mating Post Selection Guide (page 89)

Performance Specifications—page 203

No. of Pos.	Dimensions				Packaged in Tubes			Packaged in Tape & Reel		
	A	B	C	D	Contact Plating/ Part Nos.			Contact Plating/ Part Nos.		
					Plating A	Plating B	Plating C	Plating A	Plating B	Plating C
3	.500 [12.70]	.200 [5.08]	See note 3	.400 [10.16]	147744-1	147743-1	147742-1	147724-1	147730-1	147731-1
4	.600 [15.24]	.300 [7.62]	See note 3	.500 [12.70]	147744-2	147743-2	147742-2	147724-2	147730-2	147731-2
5	.700 [17.78]	.400 [10.16]	See note 3	.600 [15.24]	147744-3	147743-3	147742-3	147724-3	147730-3	147731-3
6	.800 [20.32]	.500 [12.70]	See note 3	.700 [17.78]	147744-4	147743-4	147742-4	147724-4	147730-4	147731-4
7	.900 [22.86]	.600 [15.24]	See note 3	.800 [20.32]	147744-5	147743-5	147742-5	147724-5	147730-5	147731-5
8	1.000 [25.40]	.700 [17.78]	See note 3	.900 [22.86]	147744-6	147743-6	147742-6	147724-6	147730-6	147731-6
9	1.100 [27.94]	.800 [20.32]	See note 3	1.000 [25.40]	147744-7	147743-7	147742-7	147724-7	147730-7	147731-7
10	1.200 [30.48]	.900 [22.86]	See note 3	1.100 [27.94]	147744-8	147743-8	147742-8	147724-8	147730-8	147731-8
11	1.300 [33.02]	1.000 [25.40]	See note 3	1.200 [30.48]	147744-9	147743-9	147742-9	147724-9	147730-9	147731-9
12	1.400 [35.56]	1.100 [27.94]	See note 3	1.300 [33.02]	1-147744-0	1-147743-0	1-147742-0	1-147724-0	1-147730-0	1-147731-0
13	1.500 [38.10]	1.200 [30.48]	See note 3	1.400 [35.56]	1-147744-1	1-147743-1	1-147742-1	1-147724-1	1-147730-1	1-147731-1
14	1.600 [40.64]	1.300 [33.02]	See note 3	1.500 [38.10]	1-147744-2	1-147743-2	1-147742-2	1-147724-2	1-147730-2	1-147731-2
15	1.700 [43.18]	1.400 [35.56]	See note 3	1.600 [40.64]	1-147744-3	1-147743-3	1-147742-3	1-147724-3	1-147730-3	1-147731-3
16	1.800 [45.72]	1.500 [38.10]	See note 3	1.700 [43.18]	1-147744-4	1-147743-4	1-147742-4	1-147724-4	1-147730-4	1-147731-4
17	1.900 [48.26]	1.600 [40.64]	See note 3	1.800 [45.72]	1-147744-5	1-147743-5	1-147742-5	1-147724-5	1-147730-5	1-147731-5
18	2.000 [50.80]	1.700 [43.18]	See note 3	1.900 [48.26]	1-147744-6	1-147743-6	1-147742-6	1-147724-6	1-147730-6	1-147731-6
19	2.100 [53.34]	1.800 [45.72]	See note 3	2.000 [50.80]	1-147744-7	1-147743-7	1-147742-7	1-147724-7	1-147730-7	1-147731-7
20	2.200 [55.88]	1.900 [48.26]	See note 3	2.100 [53.34]	1-147744-8	1-147743-8	1-147742-8	1-147724-8	1-147730-8	1-147731-8
30	3.200 [81.28]	2.900 [73.66]	See note 3	3.100 [78.74]	2-147744-8	2-147743-8	2-147742-8	2-147724-8	2-147730-8	2-147731-8
40	4.300 [109.22]	4.100 [104.14]	2.100 [53.34]	4.200 [106.68]	3-147744-8	3-147743-8	3-147742-8	3-147724-8	3-147730-8	3-147731-8

Notes: 1. Tyco Electronics recommends mating gold or duplex plated headers with duplex receptacle assemblies.

2. To obtain the minimum mating post length, add .020 [0.51] (not including the post lead in chamfer) to the maximum point-of-contact dimension, and .062 [1.57] for recommended board thickness if used in bottom entry application

3. No center hold down.

Mod IV Receptacle Assemblies, Single-Row, Surface Mount, .100 [2.54] x .100 [2.54] Centerline End To End Stackable without Compliant Pin Holddowns

**Surface Mount,
Dual Entry, End to End
Stackable**

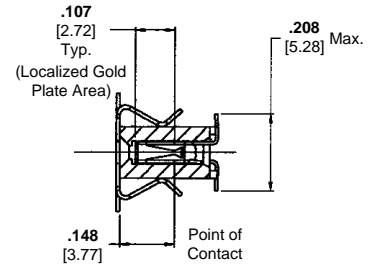
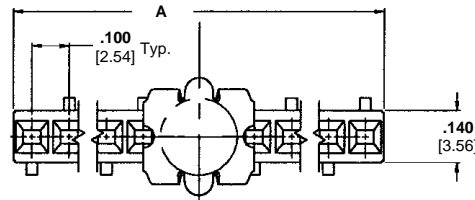
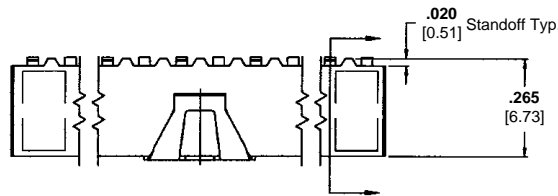

Material and Finish:

Plating A—Duplex .000030 [0.00076] gold on contact area, .000150-.000300 [0.00381-0.00762] tin-lead on solder area all over .000050 [0.00127] nickel

Plating B—Duplex .000010 [0.000254] gold on contact area, .000150-.000300 [0.00381-0.00762] tin-lead on solder area all over .000050 [0.00127] nickel

Plating C—.000100-.000200 [0.00254-0.00508] tin-lead over .000050 [0.00127]

Related Product Data:

Mateable Headers—Refer to Mating Post Selection Guide (page 89)

Performance Specifications—page 203

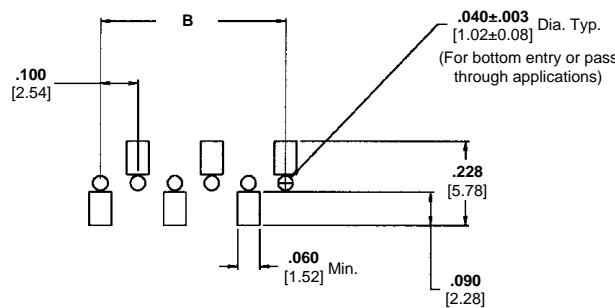

**Recommended PC Board Pad Pattern
(.008 [0.20] thick stencil)**

No. of Pos.	Dimensions		Packaged in Tubes			Packaged in Tape & Reel		
	A	B	Contact Plating/ Part Nos.			Contact Plating/ Part Nos.		
			Plating A	Plating B	Plating C	Plating A	Plating B	Plating C
3	.300 [7.62]	.200 [5.08]	147738-2	147737-2	147736-2	147723-2	147728-2	147729-2
4	.400 [10.16]	.300 [7.62]	147738-3	147737-3	147736-3	147723-3	147728-3	147729-3
5	.500 [12.70]	.400 [10.16]	147738-4	147737-4	147736-4	147723-4	147728-4	147729-4
6	.600 [15.24]	.500 [12.70]	147738-5	147737-5	147736-5	147723-5	147728-5	147729-5
7	.700 [17.78]	.600 [15.24]	147738-6	147737-6	147736-6	147723-6	147728-6	147729-6
8	.800 [20.32]	.700 [17.78]	147738-7	147737-7	147736-7	147723-7	147728-7	147729-7
9	.900 [22.86]	.800 [20.32]	147738-8	147737-8	147736-8	147723-8	147728-8	147729-8
10	1.000 [25.40]	.900 [22.86]	147738-9	147737-9	147736-9	147723-9	147728-9	147729-9
11	1.100 [27.94]	1.000 [25.40]	1-147738-0	1-147737-0	1-147736-0	1-147723-0	1-147728-0	1-147729-0
12	1.200 [30.48]	1.100 [27.94]	1-147738-1	1-147737-1	1-147736-1	1-147723-1	1-147728-1	1-147729-1
13	1.300 [33.02]	1.200 [30.48]	1-147738-2	1-147737-2	1-147736-2	1-147723-2	1-147728-2	1-147729-2
14	1.400 [35.56]	1.300 [33.02]	1-147738-3	1-147737-3	1-147736-3	1-147723-3	1-147728-3	1-147729-3
15	1.500 [38.10]	1.400 [35.56]	1-147738-4	1-147737-4	1-147736-4	1-147723-4	1-147728-4	1-147729-4
16	1.600 [40.64]	1.500 [38.10]	1-147738-5	1-147737-5	1-147736-5	1-147723-5	1-147728-5	1-147729-5
17	1.700 [43.18]	1.600 [40.64]	1-147738-6	1-147737-6	1-147736-6	1-147723-6	1-147728-6	1-147729-6
18	1.800 [45.72]	1.700 [43.18]	1-147738-7	1-147737-7	1-147736-7	1-147723-7	1-147728-7	1-147729-7
19	1.900 [48.26]	1.800 [45.72]	1-147738-8	1-147737-8	1-147736-8	1-147723-8	1-147728-8	1-147729-8
20	2.000 [50.80]	1.900 [48.26]	1-147738-9	1-147737-9	1-147736-9	1-147723-9	1-147728-9	1-147729-9
30	3.000 [76.20]	2.900 [73.66]	2-147738-9	2-147737-9	2-147736-9	2-147723-9	2-147728-9	2-147729-9
40	4.000 [101.60]	3.900 [99.06]	3-147738-9	3-147737-9	3-147736-9	3-147723-9	3-147728-9	3-147729-9

Notes: 1. Tyco Electronics recommends mating gold or duplex plated headers with duplex plated receptacle assemblies.
2. To obtain the minimum mating post length, add .020 [0.51] (not including the post lead in chamfer) to the maximum point-of-contact dimension, and .062 [1.57] for recommended board thickness if used in bottom entry application.

Mod IV Surface-Mount Receptacle Assemblies, Double-Row, .100 x .100 [2.54 x 2.54] Centers

Surface Mount, Dual Entry with Holddowns

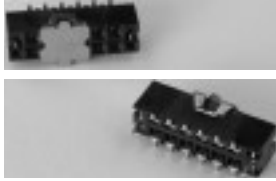

Material and Finish:

Housing—Black thermoplastic, 94V-0 rated, high temperature compatible

Contacts—Phosphor bronze, plated as follows:

Plating A—Duplex .000030 [0.00076] gold on contact area, .000150-.000300 [0.00381-0.00762] tin-lead on solder area all over .000050 [0.00127] nickel

Plating B—Duplex .000010 [0.000254] gold on contact area, .000150-.000300 [0.00381-0.00762] tin-lead on solder area all over .000050 [0.00127] nickel

Plating C—.000100-.000200 [0.00254-0.00508] tin-lead over .000050 [0.00127] nickel

Related Product Data:

Mateable Headers—Refer to Mating Post Selection Guide (page 89)

Performance Specifications—page 203

Technical Documents (page 294):

Product Specification 108-25022

Application Specification 114-25018

Additional receptacle assembly sizes are available; minimum order quantities may apply. Consult Tyco Electronics.

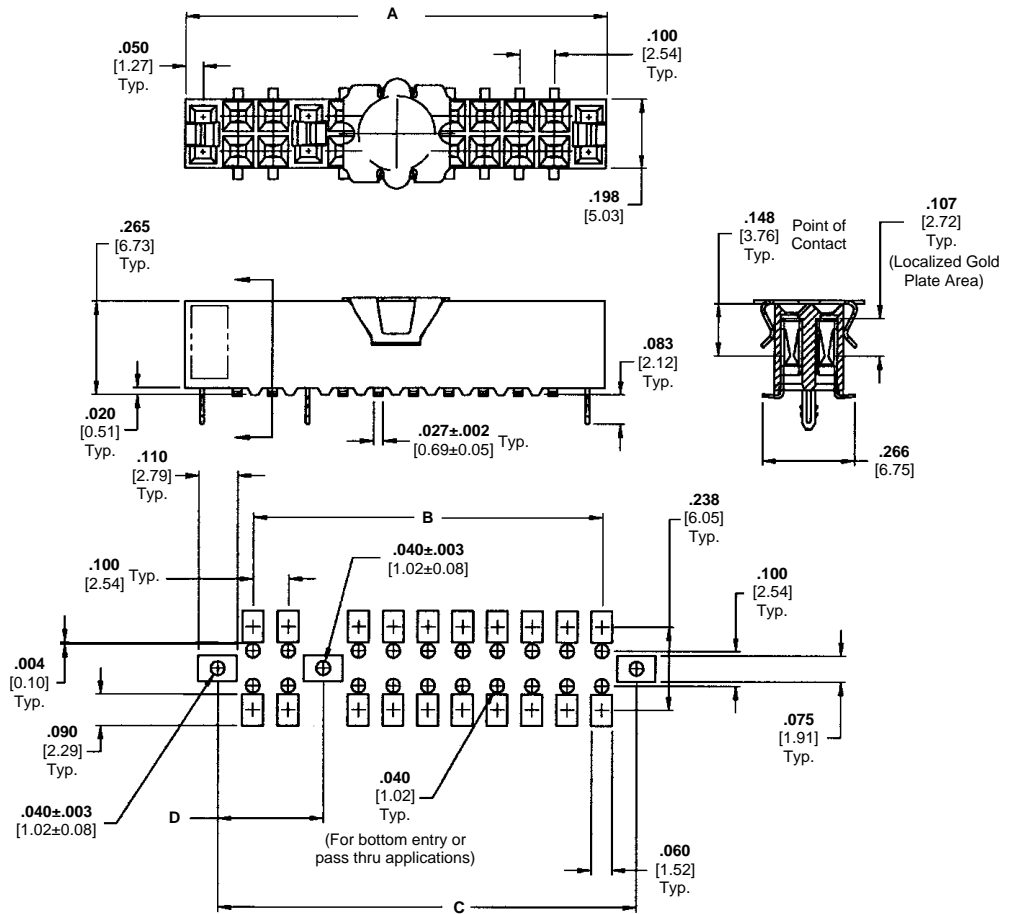

Recommended PC Board Layout
(.008 [0.20] thick stencil)

Keying Plug



Part No. 86286-1
(Plugs into receptacle contact)

Material: Natural color nylon

Surface Mount Receptacle Assemblies

5

**Mod IV Surface-Mount Receptacle Assemblies, Double-Row,
.100 x .100 [2.54 x 2.54] Centers (Continued)**

No. of Pos.	Dimensions				D	Packaged in Tubes			Packaged in Tape and Reel		
	A	B	C	See Note 1		Contact Plating/Part Nos.			Contact Plating/Part Nos.		
						Plating A	Plating B	Plating C	Plating A	Plating B	Plating C
10	.700 [17.78]	.400 [10.16]	.600 [15.24]	See Note 1	147102-5	147101-5	147103-5	147747-5	147746-5	147745-5	
14	.900 [22.86]	.600 [15.24]	.800 [20.32]	See Note 1	147102-7	147101-7	147103-7	147747-7	147746-7	147745-7	
20	1.200 [30.48]	.900 [22.86]	1.100 [27.94]	See Note 1	1-147102-0	1-147101-0	1-147103-0	1-147747-0	1-147746-0	1-147745-0	
22	1.300 [33.02]	1.000 [25.40]	1.200 [30.48]	See Note 1	1-147102-1	1-147101-1	1-147103-1	1-147747-1	1-147746-1	1-147745-1	
26	1.500 [38.10]	1.200 [30.48]	1.400 [35.56]	See Note 1	1-147102-3	1-147101-3	1-147103-3	1-147747-3	1-147746-3	1-147745-3	
30	1.700 [43.18]	1.400 [35.56]	1.600 [40.64]	See Note 1	1-147102-5	1-147101-5	1-147103-5	1-147747-5	1-147746-5	1-147745-5	
34	1.900 [48.26]	1.600 [40.64]	1.800 [45.72]	See Note 1	1-147102-7	1-147101-7	1-147103-7	1-147747-7	1-147746-7	1-147745-7	
36	2.000 [50.08]	1.700 [43.18]	1.900 [48.26]	See Note 1	1-147102-8	1-147101-8	1-147103-8	1-147747-8	1-147746-8	1-147745-8	
40	2.200 [55.88]	1.900 [48.26]	2.100 [53.34]	See Note 1	2-147102-0	2-147101-0	2-147103-0	2-147747-0	2-147746-0	2-147745-0	
46	2.500 [63.50]	2.200 [55.88]	2.400 [60.96]	See Note 1	2-147102-3	2-147101-3	2-147103-3	2-147747-3	2-147746-4	2-147745-3	
50	2.700 [68.58]	2.400 [60.96]	2.600 [66.04]	See Note 1	2-147102-5	2-147101-5	2-147103-5	2-147747-5	2-147746-5	2-147745-5	
62	3.300 [83.82]	3.000 [76.20]	3.200 [81.28]	See Note 1	3-147102-1	3-147101-1	3-147103-1	3-147747-1	3-147746-1	3-147745-1	
64	3.400 [86.36]	3.100 [78.74]	3.300 [83.82]	See Note 1	3-147102-2	3-147101-2	3-147103-2	3-147747-2	3-147746-2	3-147745-2	
66	3.500 [88.90]	3.200 [81.28]	3.400 [86.36]	See Note 1	3-147102-3	3-147101-3	3-147103-3	3-147747-3	3-147746-3	3-147745-3	
70	3.700 [95.98]	3.400 [86.36]	3.600 [91.44]	See Note 1	3-147102-5	3-147101-5	3-147103-5	3-147747-5	3-147746-5	3-147745-5	
80	4.300 [109.22]	3.900 [99.06]	4.200 [106.68]	2.100 [53.34]	4-147102-0	4-147101-0	4-147103-0	4-147747-0	4-147746-0	4-147745-0	

- Notes:** 1. No center holddown.
 2. To obtain the minimum mating post length, add .020 [0.51] (not including the post lead in chamfer) to the maximum point-of-contact dimension and .062 [1.57] for recommended board thickness in bottom entry applications.

Mod IV Surface-Mount Receptacle Assemblies, Double-Row, .100 x .100 [2.54 x 2.54] Centerline

Surface Mount, Dual Entry End to End Stackable

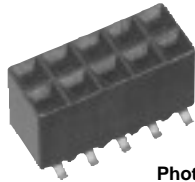

Photo 110962

Material and Finish:

Housing—Black thermoplastic, 94V-0 rated, high temperature compatible

Contacts—Phosphor bronze, plated as follows:

Plating A—Duplex .000030 [0.00076] gold on contact area, .000150-.000300 [0.00381-0.00762] tin-lead on solder area all over .000050 [0.00127] nickel

Plating B—Duplex .000010 [0.000254] gold on contact area, .000150-.000300 [0.00381-0.00762] tin-lead on solder area all over .000050 [0.00127] nickel

Plating C—.000100-.000200 [0.00254-0.00508] tin-lead over .000050 [0.00127] nickel

Related Product Data:

Mateable Headers—Refer to Mating Post Selection Guide (page 89)

Performance Specifications—page 203

Technical Documents (page 294):

Product Specification 108-25022

Application Specification 114-25018

Additional receptacle assembly sizes are available; minimum order quantities may apply. Consult Tyco Electronics.

Keying Plug



Part No. 86286-1

(Plugs into receptacle contact)

Material: Natural color nylon

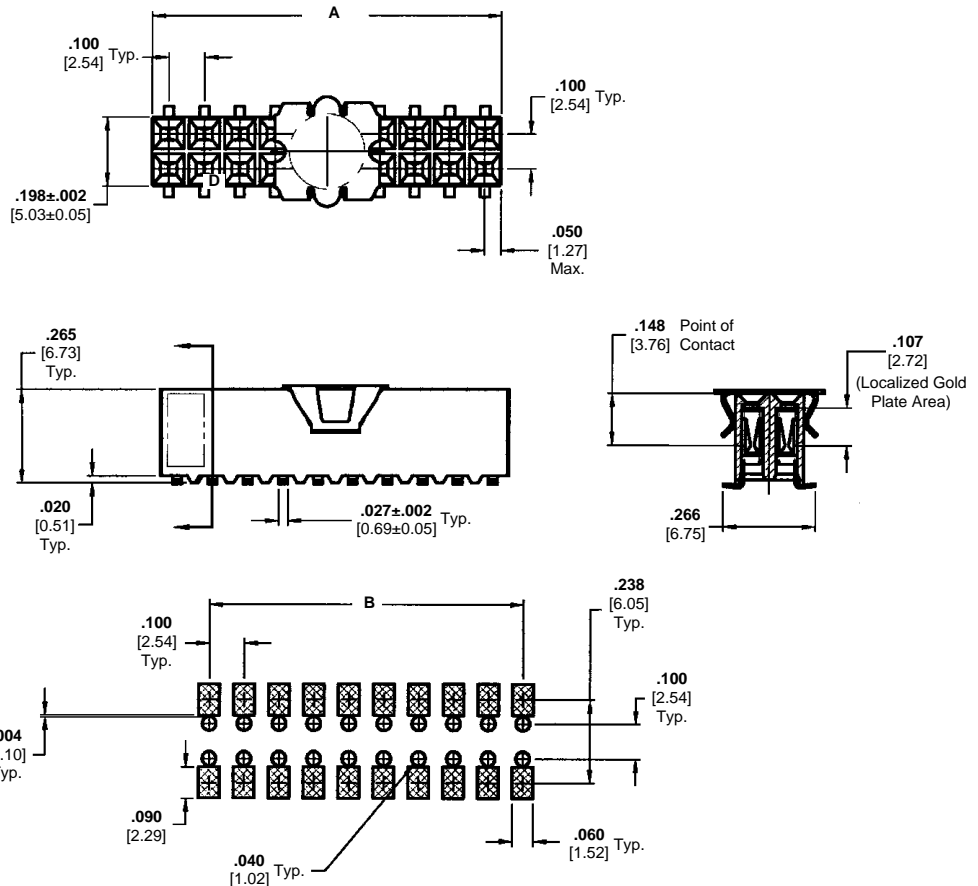

Recommended PC Board Pad Layout
(.008 [0.20] thick stencil)
(for Bottom Entry and Pass Through applications)

Surface Mount Receptacle Assemblies

5

**Mod IV Surface-Mount Receptacle Assemblies, Double-Row,
.100 x .100 [2.54 x 2.54] Centerline** (Continued)

No. of Pos.	Dimensions		Packaged in Tubes			Packaged in Tape & Reel		
			Contact Plating/ Part Nos.			Contact Plating/ Part Nos.		
	A	B	Plating A	Plating B	Plating C	Plating A	Plating B	Plating C
10	.500 [12.70]	.400 [10.16]	147741-5	147740-5	147739-5	147105-5	147104-5	147106-5
14	.700 [17.78]	.600 [15.24]	147741-7	147740-7	147739-7	147105-7	147104-7	147106-7
20	1.000 [25.40]	.900 [22.86]	1-147741-0	1-147740-0	1-147739-0	1-147105-0	1-147104-0	1-147106-0
22	1.100 [27.94]	1.000 [25.40]	1-147741-1	1-147740-1	1-147739-1	1-147105-1	1-147104-1	1-147106-1
26	1.300 [33.02]	1.200 [30.48]	1-147741-3	1-147740-3	1-147739-3	1-147105-3	1-147104-3	1-147106-3
30	1.500 [38.10]	1.400 [35.56]	1-147741-5	1-147740-5	1-147739-5	1-147105-5	1-147104-5	1-147106-5
34	1.700 [43.18]	1.600 [40.64]	1-147741-7	1-147740-7	1-147739-7	1-147105-7	1-147104-7	1-147106-7
36	1.800 [45.72]	1.700 [43.18]	1-147741-8	1-147740-8	1-147739-8	1-147105-8	1-147104-8	1-147106-8
40	2.000 [50.80]	1.900 [48.26]	2-147741-0	2-147740-0	2-147739-0	2-147105-0	2-147104-0	2-147106-0
46	2.300 [58.42]	2.200 [55.88]	2-147741-3	2-147740-3	2-147739-3	2-147105-3	2-147104-3	2-147106-3
50	2.500 [63.50]	2.400 [60.96]	2-147741-5	2-147740-5	2-147739-5	2-147105-5	2-147104-5	2-147106-5
62	3.100 [78.74]	3.000 [76.20]	3-147741-1	3-147740-1	3-147739-1	3-147105-1	3-147104-1	3-147106-1
64	3.200 [81.28]	3.100 [78.74]	3-147741-2	3-147740-2	3-147739-2	3-147105-2	3-147104-2	3-147106-2
66	3.300 [83.82]	3.200 [81.28]	3-147741-3	3-147740-3	3-147739-3	3-147105-3	3-147104-3	3-147106-3
70	3.500 [88.90]	3.400 [86.36]	3-147741-5	3-147740-5	3-147739-5	3-147105-5	3-147104-5	3-147106-5
80	4.000 [101.60]	3.900 [99.06]	4-147741-0	4-147740-0	4-147739-0	4-147105-0	4-147104-0	4-147106-0

Notes: 1. To obtain the minimum mating post length, add .020 [0.51] (not including the post lead in chamfer) to the maximum point-of-contact dimension and .062 [1.57] for recommended board thickness in bottom entry applications.

Two-Piece Printed Circuit Board Connectors

Product Facts

- Two-Piece reliability
- Two- and three-row systems available
- Short signal path for VLSI applications
- Receptacles employ dual cantilever beams and built-in anti-overstress to provide reliable connections
- Built-in guides provide alignment before contact engagement
- Closed entry receptacle housings provide lead-in ramp for positive mating of contacts
- Shrouded headers provide full pin protection
- Polarized headers
- Vertical headers available with ACTION PIN posts or .025 [0.64] square solder posts
- Repairable ACTION PIN posts
- Simple seating tooling for headers with ACTION PIN posts
- Recognized under the Component Program of Underwriters Laboratories Inc., File No. E28476
- Certified by Canadian Standards Association, File No. LR 7189

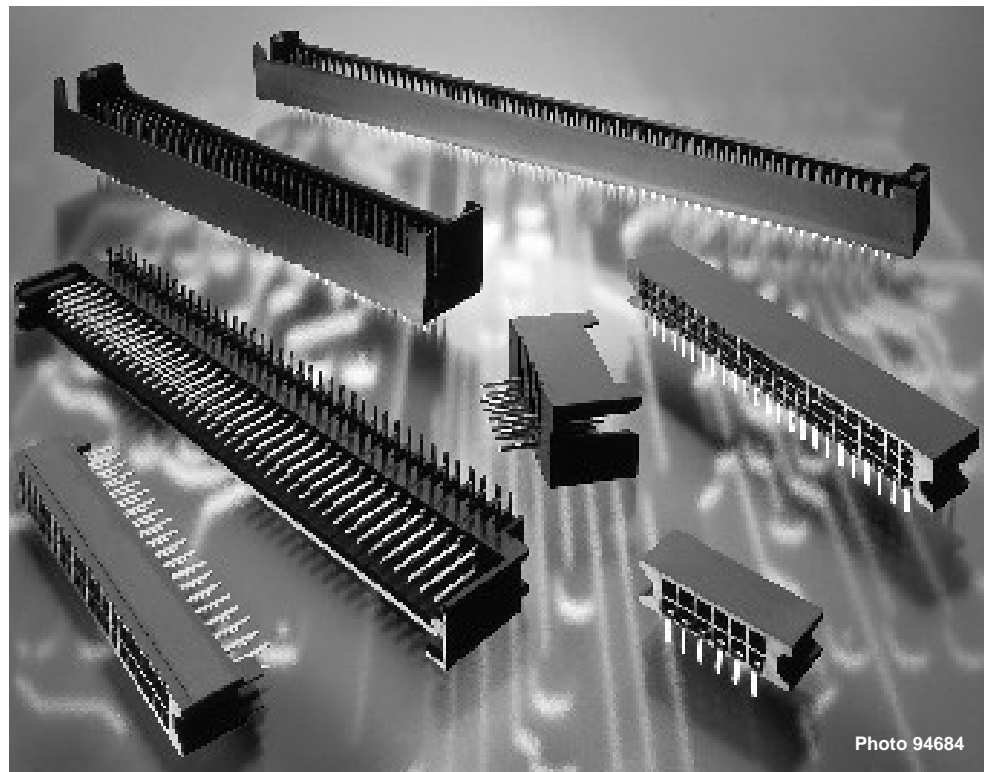

Photo 94684



ACTION PIN Posts Solder Posts



Receptacle Contact
(Double Beam with Anti-Overstress)
Board Retention Feature Available

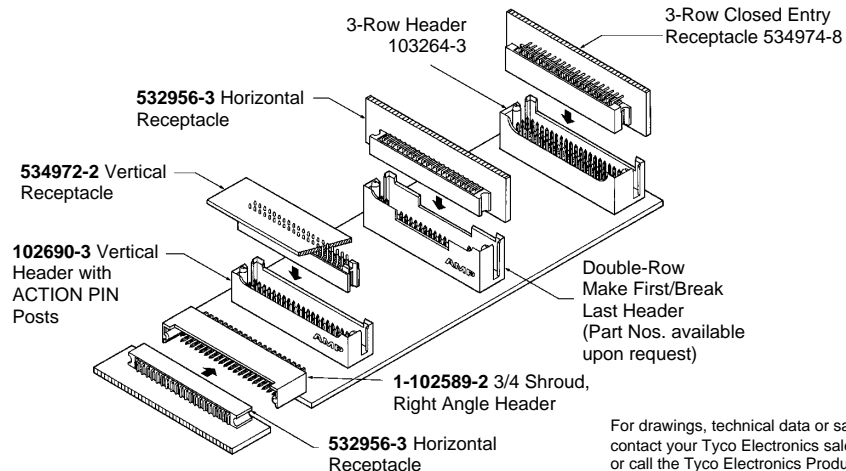

For drawings, technical data or samples, contact your Tyco Electronics sales engineer or call the Tyco Electronics Product Information Center: 1-800-522-6752

Two-Piece Printed Circuit Board Connectors

AMPMODU Two-Piece Printed Circuit Board connectors are designed to reliably and economically meet the packaging and interconnection requirements of today's sophisticated electronics.

The double row system is produced in 10 thru 200 positions in the vertical headers and horizontal receptacles, and 10 thru 160 positions in the right angle headers and vertical receptacles.

Performance Specifications

Current Rating: 3 amperes max. for single contact; 2 amperes max. per contact for fully energized connector

Voltage Rating: 250 VAC

Dielectric Rating: 750 VAC rms between contacts for one minute

The AMPMODU three-row connector system is produced in 30 through 300 positions (straight post headers and mating horizontal receptacles).

Both two- and three-row vertical headers are available with press-fit ACTION PIN posts or standard .025 [0.64] square solder posts. There is a simple seating tool for headers with ACTION PIN posts.

Termination Resistance: 12 milliohms max. at 100 milliamperes test current, and 50 millivolts open circuit voltage

Insulation Resistance: 1000 megohms after temperature/humidity cycling

Temperature Rating: Headers; -65°C to +105°C (black thermoplastic housings)
Receptacle Assemblies; -65°C to +125°C (brown or black thermoplastic housings)

A board retention feature is offered in the two-row horizontal receptacles, two-row right angle headers and two- and three-row vertical headers. Built-in guides assure accurate header and receptacle alignment before contact engagement.

Closed entry receptacle housings provide a lead-in ramp for positive mating of contacts.

Durability (Tested to): 200 cycles for .000030 [0.00076] gold plating; 75 cycles for .000015 [0.00038] gold plating

Mating Force: 8 oz. [2.22N] maximum per contact

Unmating Force: .75 oz. [0.2N] minimum per contact during third mating cycle

Electronics

**Horizontal Mount
(with Guide Pin Slots
and Standoffs)**



Material and Finish:

Housing—Thermoplastic, 94V-0 rated, high temperature compatible

Contacts—Phosphor bronze, plated as follows:

Plating A—Duplex plated .000030 [0.00076] gold on contact area, .000050-.000100 [0.00127-0.00254] bright tin-lead on solder area, with entire contact underplated .000050 [0.00127] nickel

Plating B—Duplex plated .000015 [0.00038] gold on contact area, .000050-.000100 [0.00127-0.00254] bright tin-lead on solder area, with entire contact underplated .000050 [0.00127] nickel

Related Product Data:

Mateable Headers—pages 215-216

Performance Specifications—page 211

Technical Documents (page 294):

Product Specification 108-25017

Application Specification 114-9009

Additional receptacle assembly sizes and solder tail lengths are available; minimum order quantities may apply. Consult Tyco Electronics.

Receptacle Assemblies, Board Mount, Double-Row, Closed Entry, .100 x .100 [2.54 x 2.54] Centerline

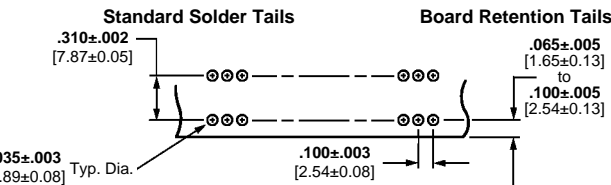
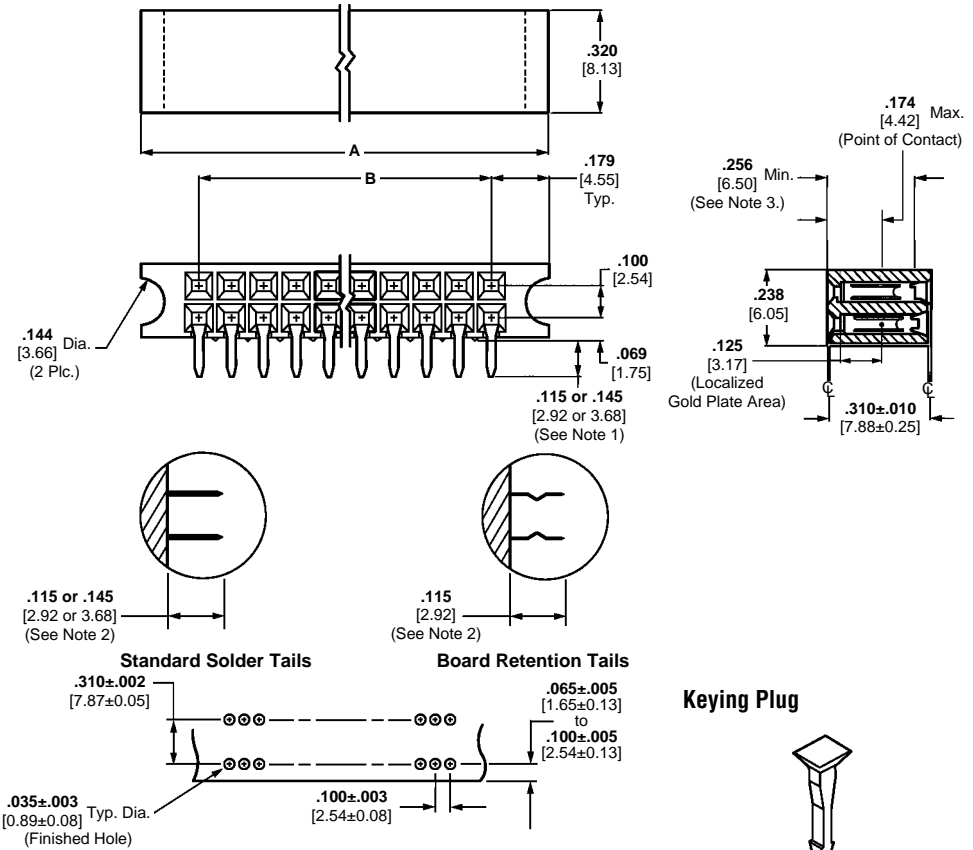

**Recommended PC Board Hole Layout
(for .055 [1.40] min. thick PC board)**

Tolerances not to accumulate within one connector pattern.

Keying Plug



Part No. 86286-1
(Plugs into receptacle contact)

Material: Natural color nylon

No. of Pos.	Dimensions		Receptacle Assembly Part Nos. with .115 [2.92] Solder Tail Lengths				Receptacle Assembly Part Nos. with .145 [3.68] Solder Tail Lengths
	A	B	Standard Solder Tails		Board Retention Tails		Standard Solder Tails
			Plating A	Plating B	Plating A	Plating B	
12	.858 [21.79]	.500 [12.70]	532956-1	532955-1	534204-2	534975-5	533009-1
14	.958 [24.33]	.600 [15.24]	—	2-532955-5	—	—	—
16	1.058 [26.87]	.700 [17.78]	532956-2	—	1-534204-0	1-534975-5	—
20	1.258 [31.95]	.900 [22.86]	532956-3	532955-3	534204-9	534975-6	—
24	1.458 [37.03]	1.100 [27.94]	532956-4	532955-4	1-534204-1	534975-7	—
30	1.758 [44.65]	1.400 [35.56]	532956-5	532955-5	534204-4	534975-8	533009-5
36	2.058 [52.27]	1.700 [43.18]	532956-6	532955-6	534204-3	534975-9	—
40	2.258 [57.35]	1.900 [48.26]	532956-7	532955-7	1-534204-2	1-534975-0	—
50	2.758 [70.05]	2.400 [60.96]	532956-8	532955-8	534204-1	1-534975-1	533009-8
60	3.258 [82.75]	2.900 [73.66]	532956-9	532955-9	534204-5	1-534975-2	533009-9
70	3.758 [95.45]	3.400 [86.36]	1-532956-0	1-532955-0	1-534204-3	1-534975-3	1-533009-0
72	3.858 [97.99]	3.500 [88.90]	1-532956-1	1-532955-1	1-534204-4	—	—
80	4.258 [108.15]	3.900 [99.06]	1-532956-2	1-532955-2	534204-8	1-534975-4	1-533009-2
86	4.558 [115.77]	4.200 [106.68]	1-532956-3	1-532955-3	—	—	1-533009-3
90	4.758 [120.85]	4.400 [111.76]	1-532956-4	1-532955-4	—	—	—
96	5.058 [128.47]	4.700 [119.38]	1-532956-5	1-532955-5	1-534204-5	—	1-533009-5
100	5.258 [133.55]	4.900 [124.46]	1-532956-6	1-532955-6	534204-6	534975-1	1-533009-6
110	5.758 [146.25]	5.400 [137.16]	1-532956-7	1-532955-7	1-534204-6	—	—
120	6.258 [158.95]	5.900 [149.86]	1-532956-8	1-532955-8	534204-7	534975-2	1-533009-8
130	6.758 [171.65]	6.400 [162.56]	2-532956-0	2-532955-0	1-534204-7	—	—
200	10.258 [260.55]	9.900 [251.46]	2-532956-3	2-532955-3	2-534204-0	534975-4	—

- Notes:** 1. .115 [2.92] tail length is for use with .062 [1.57] PC boards; .145 [3.68] tail length is for use with .093 [2.36] PC boards.
2. Receptacle assemblies with low force contacts are available, consult Tyco Electronics.
3. .256 [6.50] minimum positive pin stop to prevent shorting between rows.

Catalog 1307819
Revised 6-04

www.tycoelectronics.com

Dimensions are in inches and millimeters unless otherwise specified. Values in brackets are metric equivalents.

Dimensions are shown for reference purposes only. Specifications subject to change.

USA: 1-800-522-6752
Canada: 1-905-470-4425
Mexico: 01-800-733-8926
C. America: 52-55-5-729-0425

South America: 55-11-3611-1514
Hong Kong: 852-2735-1628
Japan: 81-44-844-8013
UK: 44-141-810-8967

Receptacle Assemblies, Board Mount, Double-Row, Closed Entry, .100 x .100 [2.54 x 2.54] Centerline (Continued)

Vertical Mount (with Guide Pin Slots and Standoffs)

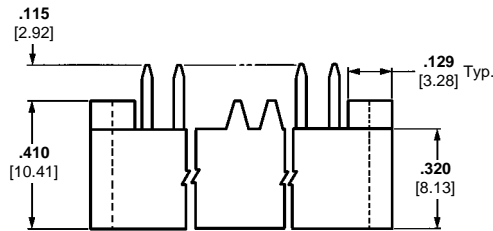

Material and Finish:

Housing—Thermoplastic, 94V-0 rated, high temperature compatible

Contacts—Phosphor bronze, duplex plated .000030 [0.00076] gold on contact area, .000050-.000100 [0.00127-0.00254] bright tin-lead on solder area, with entire contact underplated .000050 [0.00127] nickel

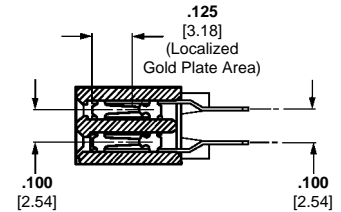
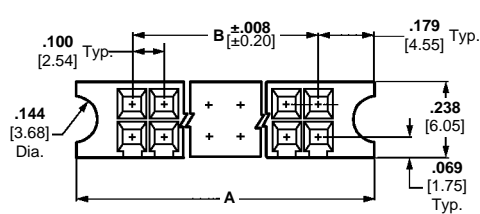

Related Product Data:

Mateable Headers—pages 215-216

Performance Specifications—page 211

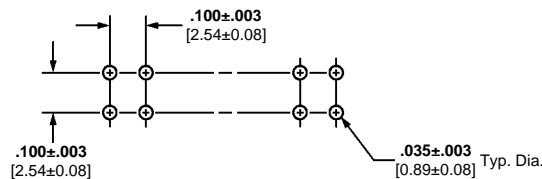

Recommended PC Board Hole Layout (for .055 [1.40] min. thick PC board)

Tolerances not to accumulate within one connector pattern.

Technical Documents (page 294):

Product Specification 108-25017

Application Specification 114-9009

Additional receptacle assembly sizes and solder tail lengths are available; minimum order quantities may apply. Consult Tyco Electronics.

Keying Plug



Part No. 86286-1

(Plugs into receptacle contact)

Material: Natural color nylon

No. of Pos.	Dimensions		Receptacle Assembly Part Nos.
	A	B	
30	1.758 [44.65]	1.400 [35.56]	534972-1
40	2.258 [57.35]	1.900 [48.26]	534972-2
50	2.758 [70.05]	2.400 [60.96]	534972-3
60	3.258 [82.75]	2.900 [73.66]	534972-4
70	3.758 [95.45]	3.400 [86.36]	534972-5
80	4.258 [108.15]	3.900 [99.06]	534972-6
90	4.758 [120.85]	4.400 [111.76]	534972-7
100	5.258 [133.55]	4.900 [124.46]	534972-8
120	6.258 [158.95]	5.900 [149.86]	1-534972-0

**Receptacle Assemblies, Board Mount, Triple-Row,
Closed Entry, .100 x .100 [2.54 x 2.54] Centerline** (Continued)

**Horizontal Mount
(with Guide Pin Slots
and Standoffs)**

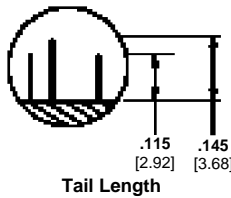
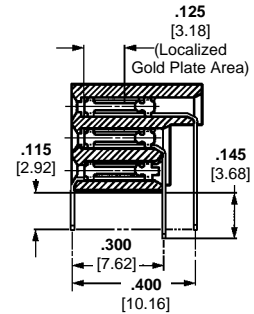
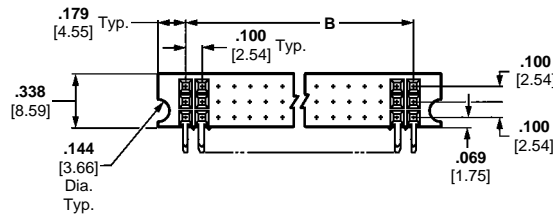
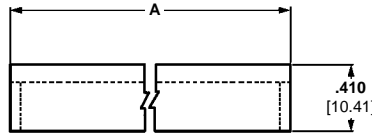
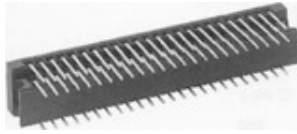

Material and Finish:

Housing—Thermoplastic, 94V-0 rated, high temperature compatible

Contacts—Phosphor bronze, plated as follows:

Plating A—Duplex plated .000030 [0.00076] gold on contact area, .000050-.000100 [0.00127-0.00254] bright tin-lead on solder area, with entire contact underplated .000050 [0.00127] nickel

Related Product Data:

Mateable Headers—page 218

Performance Specifications—page 211

Technical Documents (page 294):

Product Specification 108-25017

Application Specification 114-9009

Additional receptacle assembly sizes and solder tail lengths are available; minimum order quantities may apply. Consult Tyco Electronics.

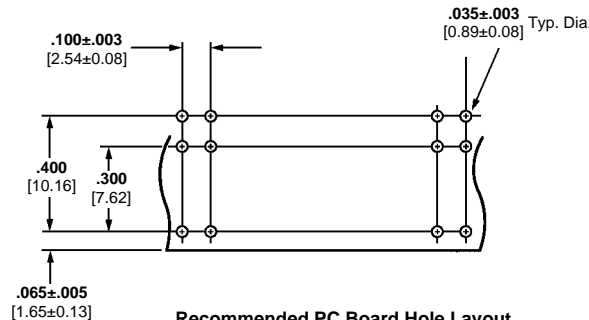

Recommended PC Board Hole Layout
(for .055 [1.40] min. thick PC board)

Tolerances not to accumulate within one connector pattern.

No. of Pos.	Dimensions		Receptacle Assembly Part Nos. Plating A
	A	B	
72	2.658 [67.51]	2.300 [58.42]	534974-3
93	3.358 [85.29]	3.000 [76.20]	534974-4
96	3.458 [87.83]	3.100 [78.74]	534974-5
150	5.258 [133.55]	4.900 [124.46]	534974-8
210	7.258 [184.35]	6.900 [175.26]	1-534974-1

Keying Plug

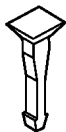

Part No. 86286-1

(Plugs into receptacle contact)

Material: Natural color nylon

Headers, Straight Post, Double-Row, .100 x .100 [2.54 x 2.54] Centerline

Solder Posts and ACTION PIN Posts (with Pin Protection and Guide Pins)



Material and Finish:

Housing—Black thermoplastic, 94V-0 rated

Posts—Phosphor bronze, plated as follows:

Plating A—Duplex plated .000030 [0.00076] gold on contact area, .000100-.000200 [0.00254-0.00508] bright tin-lead on termination end, with entire post underplated .000050 [0.00127] nickel

Plating B—Duplex plated .000015 [0.00038] gold on contact area, .000100-.000200 [0.00254-0.00508] bright tin-lead on termination end, with entire post underplated .000050 [0.00127] nickel

Plating C—Selectively plated .000030 [0.00076] gold on contact area and .000015 [0.00038] gold on termination end, with gold flash over .000050 [0.00127] nickel on entire post

Related Product Data:

Mateable Receptacles— pages 212-213

Performance Specifications— page 211

ACTION PIN Posts— pages 167, 168

Application Tooling— pages 169

Technical Documents (page 294):

Product Specification 108-25017

Application Specification 114-9009

Additional header sizes are available; minimum order quantities may apply. Consult Tyco Electronics.

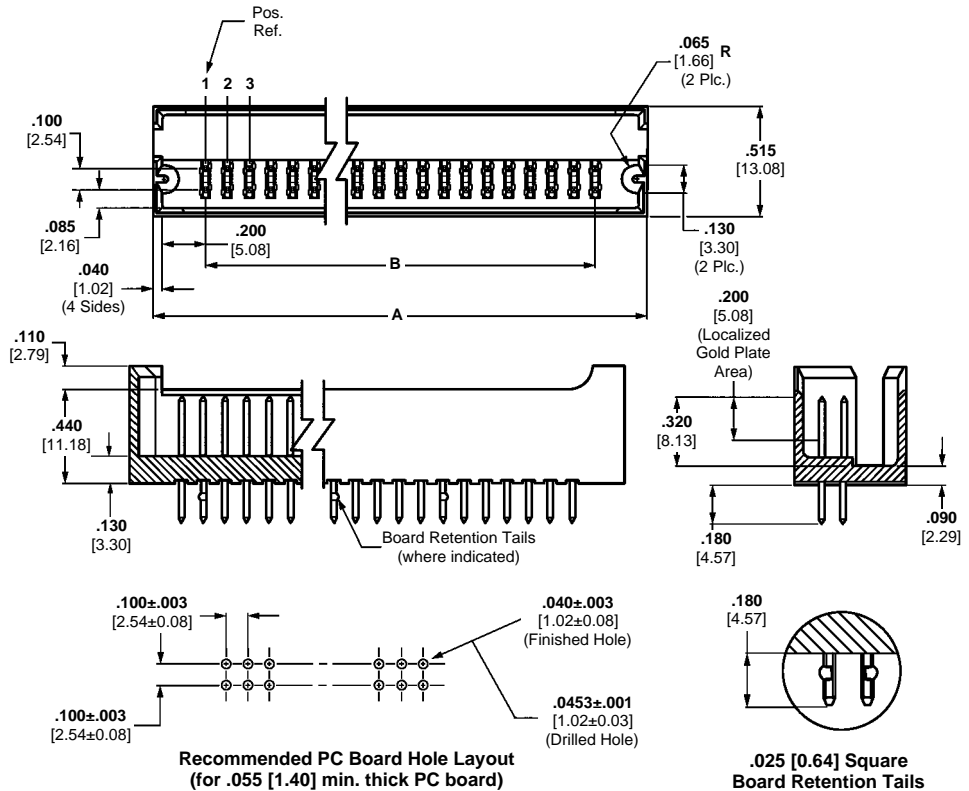

Recommended PC Board Hole Layout (for .055 [1.40] min. thick PC board)

Tolerances not to accumulate within one connector pattern.

No. of Pos.	Dimensions		Header Part Nos. with .180 [4.57] Tail Length			
			Standard Solder Tails		Board Retention Tails	
	A	B	Plating A	Plating B	Plating A	Plating B
12	.980 [24.89]	.500 [12.70]	102692-1	102567-1	1-534978-6	534257-5
14	1.080 [27.43]	.600 [15.24]	—	2-102567-3	—	—
16	1.180 [29.97]	.700 [17.78]	1-102692-5	—	534978-2	1-534257-4
20	1.380 [35.05]	.900 [22.86]	1-102692-6	1-102567-1	534978-3	534257-6
24	1.580 [40.13]	1.100 [27.94]	102692-2	102567-2	534978-4	534257-7
30	1.880 [47.75]	1.400 [35.56]	1-102692-7	1-102567-3	534978-5	534257-8
36	2.180 [55.37]	1.700 [43.18]	102692-3	102567-3	534978-6	534257-9
40	2.380 [60.45]	1.900 [48.26]	1-102692-3	1-102567-2	534978-7	1-534257-0
50	2.880 [73.15]	2.400 [60.96]	102692-4	102567-6	534978-8	1-534257-5
60	3.380 [85.85]	2.900 [73.66]	102692-5	102567-4	534978-9	1-534257-1
70	3.880 [98.55]	3.400 [86.36]	1-102692-4	1-102567-0	1-534978-5	1-534257-2
72	3.980 [101.09]	3.500 [88.90]	1-102692-8	1-102567-6	1-534978-0	—
80	4.380 [111.25]	3.900 [99.06]	102692-6	102567-8	1-534978-1	534257-1

Note: Headers with make first/break last posts can be made available, consult Tyco Electronics.

Headers, Straight Post, Double-Row, .100 x .100 [2.54 x 2.54]

Centerline (Continued)

No. of Pos.	Dimensions		Header Part Nos. with .180 [4.57] Tail Length			
			Standard Solder Tails		Board Retention Tails	
	A	B	Plating A	Plating B	Plating A	Plating B
86	4.680 [118.87]	4.200 [106.68]	1-102692-9	1-102567-7	—	—
90	4.880 [123.95]	4.400 [111.76]	1-102692-2	1-102567-4	—	—
96	5.180 [131.57]	4.700 [119.38]	102692-7	102567-5	1-534978-7	—
100	5.380 [136.65]	4.900 [124.46]	102692-8	102567-9	1-534978-8	534257-2
110	5.880 [149.35]	5.400 [137.16]	1-102692-0	1-102567-5	1-534978-2	—
120	6.380 [162.05]	5.900 [149.86]	102692-9	102567-7	1-534978-3	534257-3
130	6.880 [174.75]	6.400 [162.56]	2-102692-0	1-102567-9	1-534978-9	—
200	10.380 [263.65]	9.900 [251.46]	1-102692-1	2-102567-1	534978-1	1-534257-9

Note: Headers with make first/break last posts can be made available, consult Tyco Electronics Incorporated.

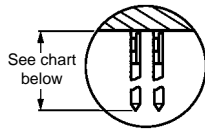

.025 [0.64] Square ACTION PIN Tails

ACTION PIN Post Replacement Part Nos.

.250 [6.35] Tail Length
 Plating A 102824-9
 Plating B 1-102824-0

.480 [12.19] Tail Length
 Plating A 102824-6
 Plating B 102824-2
 Plating C 102824-3
.680 [17.27] Tail Length
 Plating C 102824-7

No. of Pos.	Dimensions		Header Part Nos. with ACTION PINPosts				
			.250 [6.35] Tail Length		.480 [12.19] Tail Length		.680 [17.27] Tail Length
	A	B	Plating A	Plating B	Plating A	Plating C	Plating C
12	.980 [24.89]	.500 [12.70]	102690-1	103291-4	—	—	—
14	1.080 [27.43]	.600 [15.24]	—	103291-3	—	—	—
20	1.380 [35.05]	.900 [22.86]	1-102690-3	103291-6	—	—	—
24	1.580 [40.13]	1.100 [27.94]	102690-2	103291-7	—	—	—
36	2.180 [55.37]	1.700 [43.18]	102690-3	103291-9	—	—	—
40	2.380 [60.45]	1.900 [48.26]	1-102690-6	103291-2	—	—	—
50	2.880 [73.15]	2.400 [60.96]	102690-4	1-103291-0	—	—	—
60	3.380 [85.85]	2.900 [73.66]	102690-5	1-103291-1	—	—	—
70	3.880 [98.55]	3.400 [86.36]	1-102690-7	1-103291-2	—	—	—
80	4.380 [111.25]	3.900 [99.06]	102690-6	1-103291-4	—	—	—
90	4.880 [123.95]	4.400 [111.76]	1-102690-1	1-103291-6	—	—	—
96	5.180 [131.57]	4.700 [119.38]	102690-7	1-103291-8	—	—	—
100	5.380 [136.65]	4.900 [124.46]	102690-8	1-103291-9	—	—	102777-3
120	6.380 [162.05]	5.900 [149.86]	102690-9	2-103291-1	102691-9	1-102666-1	102777-1
130	6.880 [174.75]	6.400 [162.56]	—	—	—	102666-9	—

- Notes:**
1. Other header sizes can be made available upon request.
 2. Headers with ACTION PIN posts are for use with .093 [2.36] nominal or thicker PC boards.
 3. Application tooling for installing headers with ACTION PIN posts is shown on pages 128 and 129.
 3. Headers with .250 [6.35] tail length can be made available with make first/break last contacts, consult Tyco Electronics.

Headers, Right-Angle Post, Double-Row, .100 x .100 [2.54 x 2.54] Centerline

**Card Extender
(with Pin Protection
and Guide Pins)**

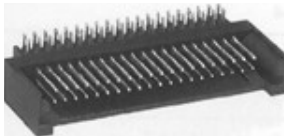

Material and Finish:

Housing—Black thermoplastic, 94V-rated

Posts—Phosphor bronze, plated as follows:

Plating A—Duplex plated .000030 [0.00076] gold on contact area, .000100-.000200 [0.00254-0.00508] bright tin-lead on solder area, with entire post underplated .000050 [0.00127] nickel

Plating B—Duplex plated .000015 [0.00038] gold on contact area, .000100-.000200 [0.00254-0.00508] bright tin-lead on solder area, with entire post underplated .000050 [0.00127] nickel

Related Product Data:

Mateable Receptacles—pages 212-213

Performance Specifications—page 211

Technical Documents (page 294):

Product Specification 108-25017

Application Specification 114-9009

Additional header sizes are available; minimum order quantities may apply. Consult Tyco Electronics.

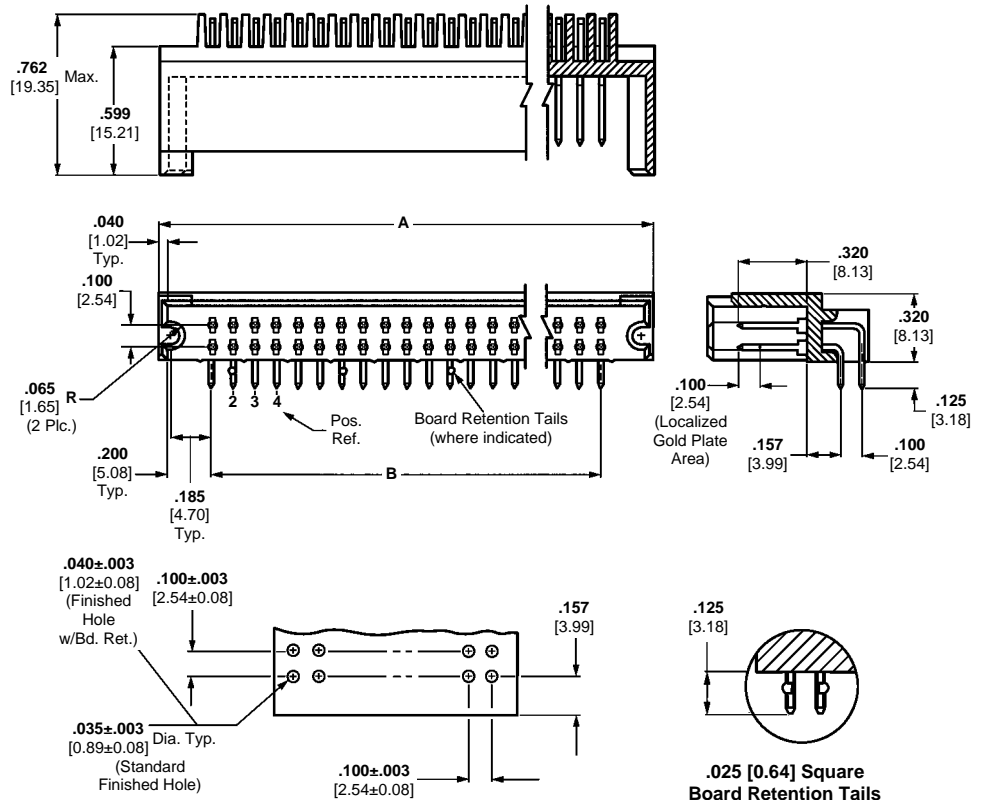

**Recommended PC Board Hole Layout
(for .055 [1.40] min. thick PC board)**

Tolerances not to accumulate within one connector pattern.

No. of Pos.	Dimensions		Header Part Nos. with .125 [3.18] Tail Length		
	A	B	Standard Solder Tails		Board Retention Tails
			Plating A	Plating B	Plating A
12	.980 [24.89]	.500 [12.70]	1-102802-2	102589-8	534245-5
16	1.180 [29.97]	.700 [17.78]	1-102802-4	—	534245-4
20	1.380 [35.05]	.900 [22.86]	1-102802-5	1-102589-2	534245-6
24	1.580 [40.13]	1.100 [27.94]	1-102802-3	102589-6	534245-7
30	1.880 [47.75]	1.400 [35.56]	1-102802-6	102589-4	534245-2
36	2.180 [55.37]	1.700 [43.18]	102802-3	102589-2	534245-8
40	2.380 [60.45]	1.900 [48.26]	102802-8	1-102589-3	—
50	2.880 [73.15]	2.400 [60.96]	102802-4	102589-5	534245-1
60	3.380 [85.85]	2.900 [73.66]	102802-9	102589-7	—
72	3.980 [101.09]	3.500 [88.90]	1-102802-7	1-102589-7	—
80	4.380 [111.25]	3.900 [99.06]	102802-5	102589-1	1-534245-0
90	4.880 [123.95]	4.400 [111.76]	1-102802-0	1-102589-4	—
100	5.380 [136.65]	4.900 [124.46]	102802-6	102589-3	1-534245-1
120	6.380 [162.05]	5.900 [149.86]	102802-2	1-102589-1	534245-3
130	6.880 [174.75]	6.400 [162.56]	1-102802-9	1-102589-9	1-534245-3

Note: Headers with make first/break last posts can be made available, consult Tyco Electronics.

Headers, Straight Post, Triple-Row, .100 x .100 [2.54 x 2.54] Centerline

**Solder Posts
(with Pin Protection
and Guide Pins)**

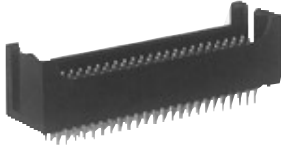

Material and Finish:

Housing—Black thermoplastic, 94V-0 rated

Posts—Phosphor bronze, plated as follows:

Plating A—Duplex plated .000030 [0.00076] gold on contact area, .000100-.000200 [0.00254-0.00508] bright tin-lead on termination end, with entire post underplated .000050 [0.00127] nickel

Related Product Data:

Mateable Receptacles—page 214

Performance Specifications—page 211

Technical Documents (page 294):
Product Specification 108-25017

Application Specification
114-9009

Additional header assembly sizes are available; minimum order quantities may apply. Consult Tyco Electronics.

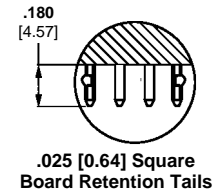
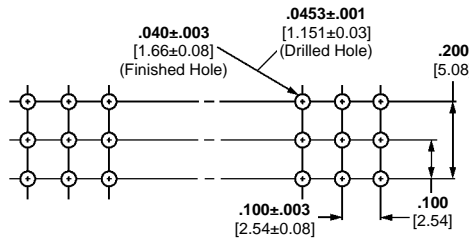
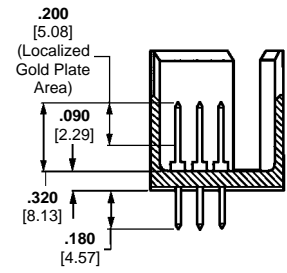
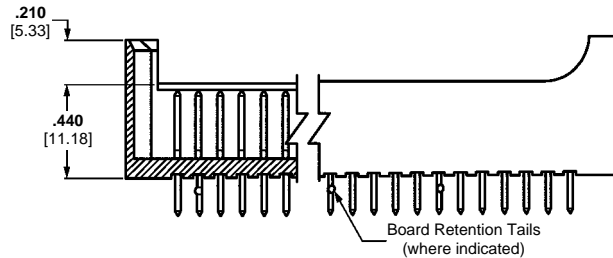
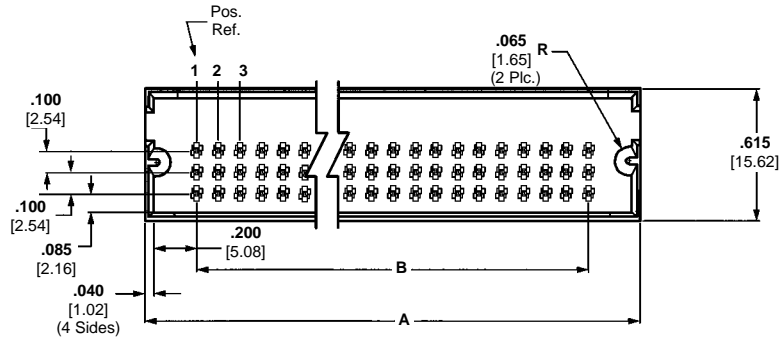

**Recommended PC Board Hole Layout
(for .055 [1.40] min. thick PC board)**

Tolerances not to accumulate within one connector pattern.

No. of Pos.	Dimensions		Header Part Nos. with .180 [4.57] Tail Length	
	A	B	Standard Solder Tails Plating A	Board Retention Tails Plating A
72	2.780 [70.61]	2.300 [58.42]	103264-1	534258-1
93	3.480 [88.39]	3.000 [76.20]	—	534258-3
150	5.380 [136.65]	4.900 [124.46]	103264-3	—
210	7.380 [187.45]	6.900 [175.26]	103264-4	—

Headers, VRM (Voltage Regulator Module), .100 x .100 [2.54 x 2.54] Centerline

Solder Posts and ACTION PIN Posts (with Pin Protection, Guide Ribs, and Latching)

Material and Finish:

Housing—Beige thermoplastic, 94V-0 rated

Posts—Copper alloy, duplex plated .000030 [0.00076] gold on contact area, .000100-.000200 [0.00254-0.00508] matte tin-lead on termination end, with entire post underplated .000050 [0.00127] nickel

Related Product Data:

Mateable Receptacles— pages 212-213

Performance Specifications— page 211

ACTION PIN Posts— page 167, 168

Application Tooling— pages 169

Technical Documents (page 294):

Product Specification 108-25017

Application Specification 114-9009

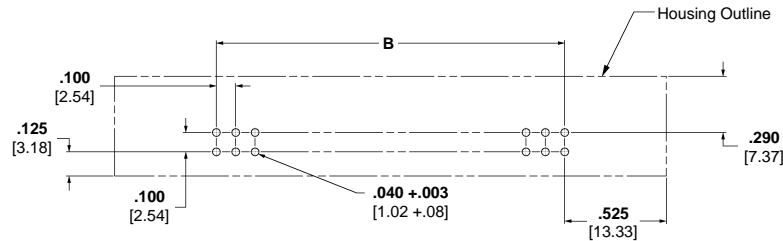
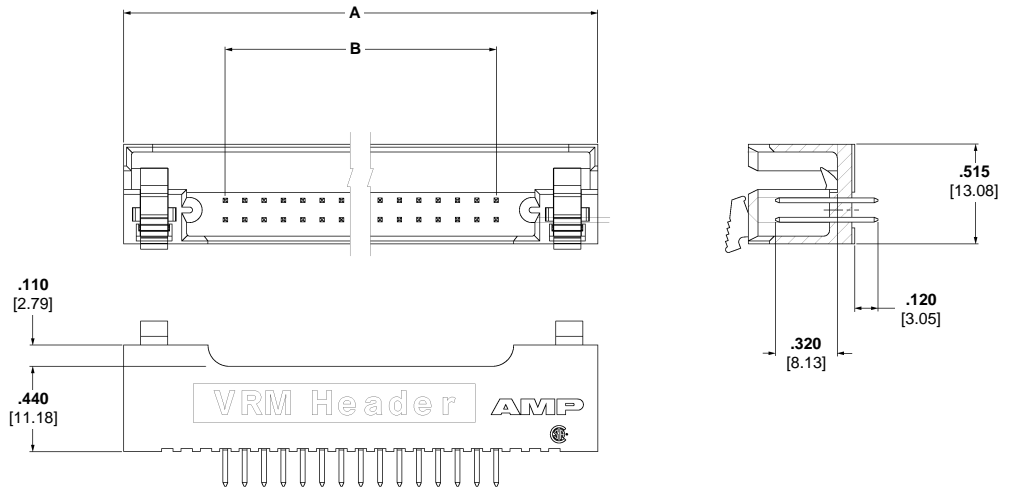

Recommended PC Board Hole Layout

No of Pos	Dimensions		Header Part No.	
	A	B	Standard Solder Tails	.250 Length ACTION PIN Tails
30	2.450 [62.23]	1.400 [35.56]	146205-1	—
40	3.095 [78.62]	1.900 [48.26]	—	147254-1
	3.100 [78.74]	1.900 [48.26]	146315-1	—

Accessories: End Shrouds for Machine-Applied Posts

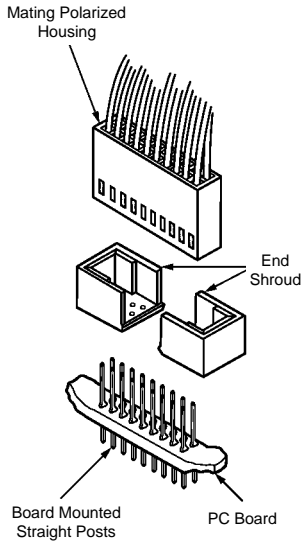

Typical Assembly

Technical Documents (page 294):

Single-Row, .100 [2.54] Centers
Part No. 102338-1

Material:
 Black thermoplastic, flame retardant

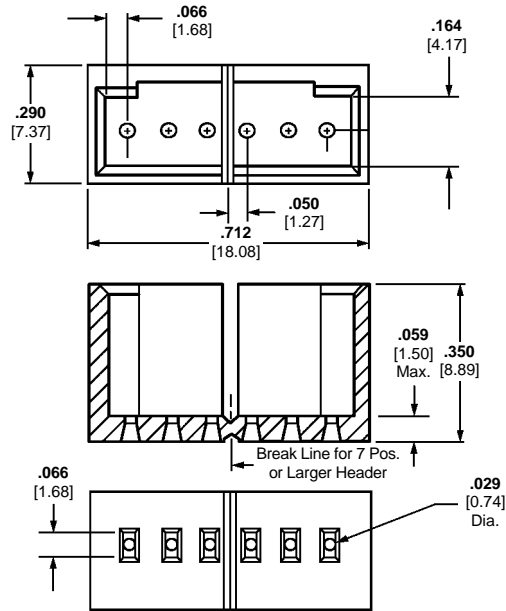

Double-Row, .100 x .100 [2.54 x 2.54] Centers
Part No. 102114-1

Material:
 Black glass-filled polyester

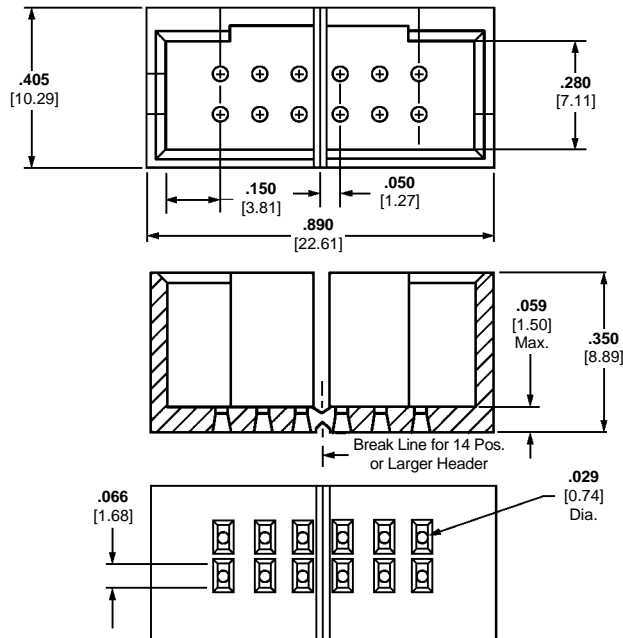

Accessories: Barrier Insert, Part No. 87743-1

Material:

Black polyester

Technical Documents (page 294):

The barrier insert can be used on double row headers (.100 x .100 [2.54 x 2.54] centers), including shrouded versions—3 and 4 sides, as well as unshrouded straight post headers. With one barrier insert several configurations can be obtained, providing headers with capabilities of accepting various combinations of polarized and non-polarized AMPMODU connectors.

For unshrouded headers, the barrier insert is used to establish polarization and to compartmentalize the header. For shrouded headers, the barrier insert is used to compartmentalize the header, while maintaining polarization. The barrier insert itself is notched to facilitate cutting off the ends with a simple tool such as tin snips or scissors to achieve the desired configuration.

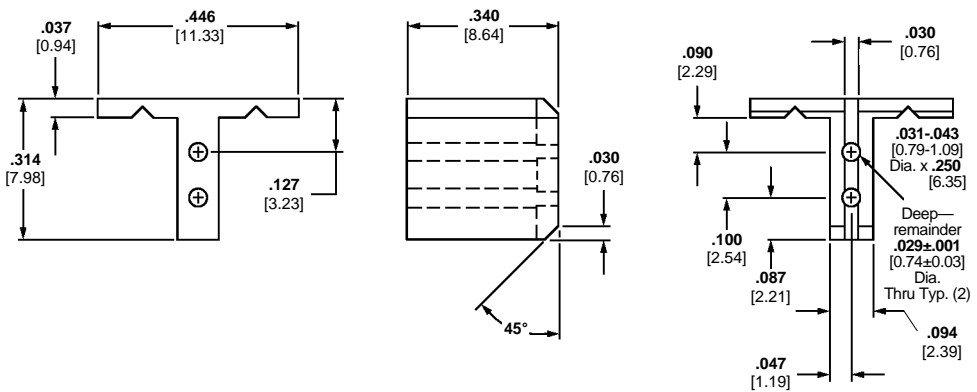

Barrier Insert Cutoffs

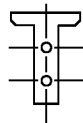

Fig. 1
Partial Cutoff
(Left and Right Sides)

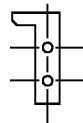

Fig. 2
Partial Cutoff
(Left Side)
Complete Cutoff
(Right Side)

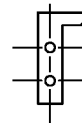

Fig. 3
Complete Cutoff
(Left Side)
Partial Cutoff
(Right Side)

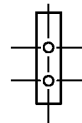
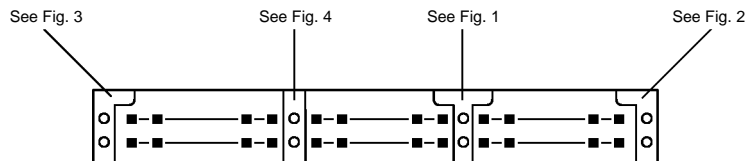

Fig. 4
Complete Cutoff
(Left and Right Sides)

Typical Barrier Insert Applications

For Unshrouded Double-Row, Straight Post Headers, .100 x .100 [2.54 x 2.54] Centers



Note: All configurations of barrier inserts compartmentalize headers and maintain polarization, except bar (Fig. 4) configuration, which is used primarily for compartmentalizing headers.

For Shrouded Double-Row, 3 and 4 Sided Headers, .100 x .100 [2.54 x 2.54] Centers

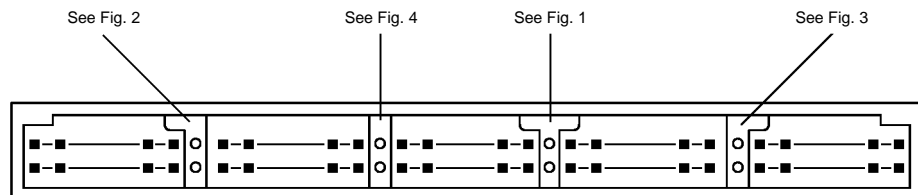

Note: Right-angle (Figs. 2 and 3) and "T" (Fig. 1) configurations of barrier insert establish polarization; bar (Fig. 4) configuration of barrier insert compartmentalizes header.

Accessories: Snap-In Polarizer for Low Profile Headers

Material:

Black thermoplastic, flame retardant

Part Nos.

499991-2 (Packaged 50 per bag)

499991-3 (Packaged 1000 per bag)

Related Product Data:

Low Profile Headers used with—
pages 152-157

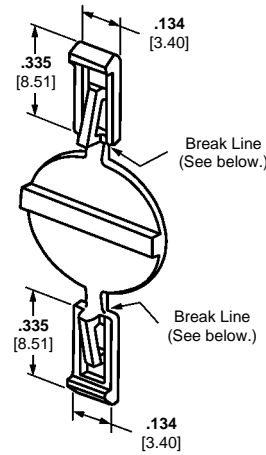

The snap-in polarizer provides military polarization for low profile headers. Installation of the polarizer is as follows:



Orient the polarizer so that the polarizing slot of the housing is on the same side as the inner wall (post side) of the header housing.

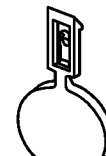
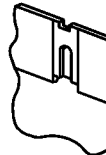

Slide the polarizer over the polarizing slot of the housing until the latch engages the hole. Snap off the tab at the break line next to the housing. Using the remaining polarizer, repeat the process for the other housing location.

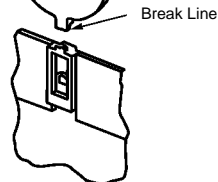

Note: For Post Shunts, contact TYCO ELECTRONICS.