

## AMPMODU System 50 Connectors

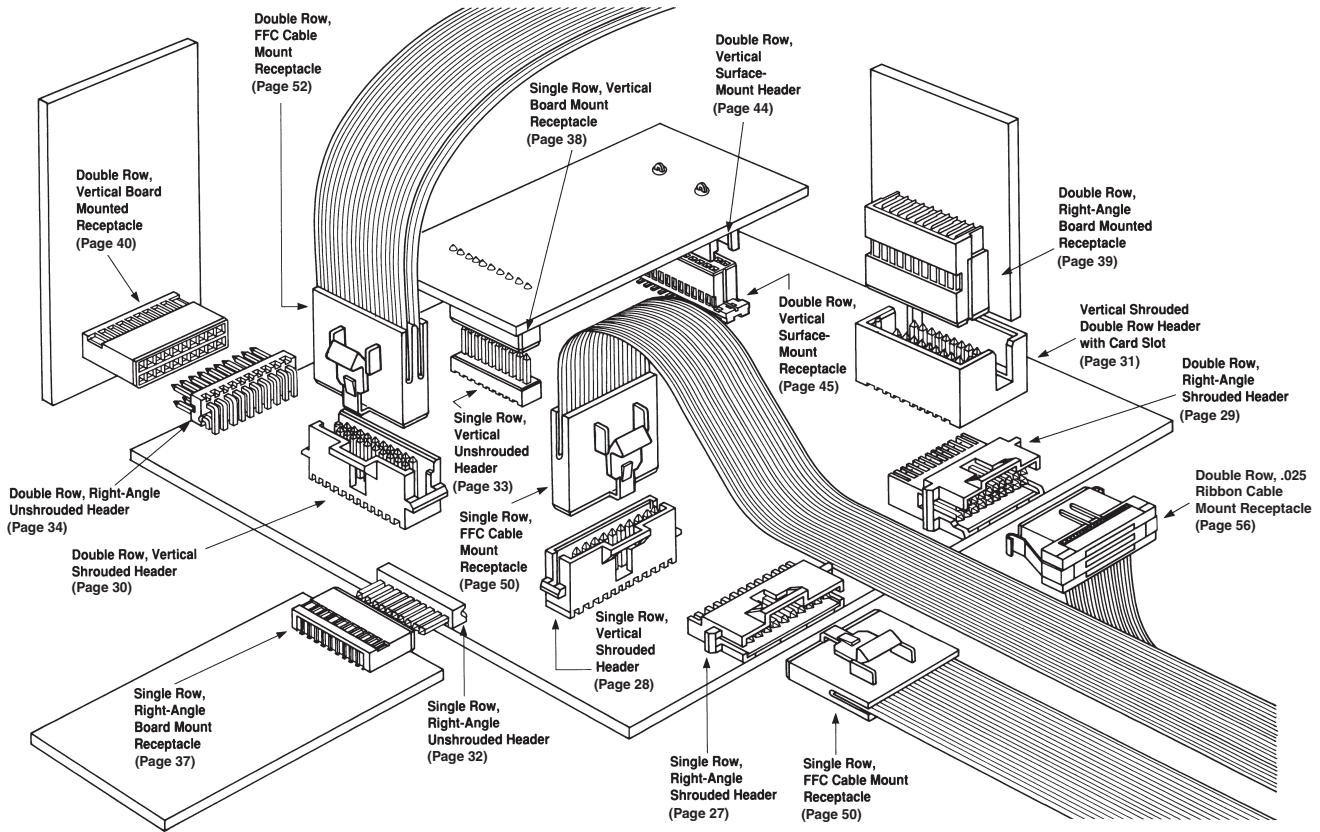

The AMPMODU System 50 connector family includes a wide variety of high density board-to-board (thru-hole and surface-mount) and cable-to-board connectors. AMPMODU System 50 is composed of one- and two-row receptacles and post headers on .050 x .100 [1.27 x 2.54] spacing between contacts for extreme density and efficient use of printed circuit board area.

AMPMODU System 50 receptacles and header assemblies can be categorized in three groups: board-mount headers, board-mount receptacles and cable-to-board receptacles. Receptacle contacts and mating .015 [0.38] square posts are formed from high conductivity copper alloy and are selectively plated with gold to promote higher performance and reliability.

Board-mounted thru-hole post headers and receptacle connectors are available for right-angle and vertical mating configurations. Surface-mounted connectors are available in vertical, double row styles for parallel stacking applications. Shrouded post headers provide polarization to mating cable receptacles and aid alignment of mating connectors. Unshrouded headers allow close stacking of daughter cards. Vertical stacking connectors space parallel mated boards as shown in the illustration on page 63. Housings on all board-mount assemblies are made of high temperature tolerant materials and incorporate stand-offs for free drainage of flux cleaning solutions.

Cable-to-board connectors have integral latches for positive locking to shrouded

mating headers (thru-hole or surface-mount). Ribbon cable connectors mass terminate 30 AWG [0.05 mm<sup>2</sup>] solid and 32 AWG [0.03 mm<sup>2</sup>] stranded, .025 [0.64] centerline ribbon cable with PVC or Teflon<sup>®</sup> insulation.

Connectors for mass termination to FFC cable or flexible etched circuitry have dual beam contacts; options include shielded cable and solder tabs. Both types of cable connectors are available as component parts and as completed assemblies.

The variety of components and application possibilities, combined with small size and outstanding quality, make AMPMODU System 50 suitable for high density systems.

- **Recognized under the Component Program of Underwriters Laboratories Inc.** File No. E28476 
- **Certified by Canadian Standards Association\*,** File No. LR 7189 

\*CSA certification pending on certain products, as noted.

**Dimensioning:**  
Dimensions are in inches and millimeters. Values in brackets are metric equivalents. Metric symbols used are:  
mm (millimeter)  
cm (centimeter)  
m (meter)  
mm<sup>2</sup> (square millimeter)  
C (Celsius)  
N (newton)  
kg (kilogram)

- **Produced under a Quality Management System certified to ISO 9001**

A copy of the certificate is available upon request.



Teflon<sup>®</sup> is a trademark of E.I. du Pont de Nemours and Company.

## Thru-Hole Headers—Shrouded, .050 x .100 [1.27 x 2.54] Centerline, Board-to-Board

### Product Facts

- High density; contacts spaced on .050 x .100 [1.27 x 2.54] centers
- Single row; select sizes 4 thru 50 positions
- Double row; select sizes 10 thru 100 positions
- Stand-offs for ease of cleaning
- High temperature tolerant thermoplastic housings
- Shrouded and unshrouded headers available in single and double row, vertical and right-angle configurations

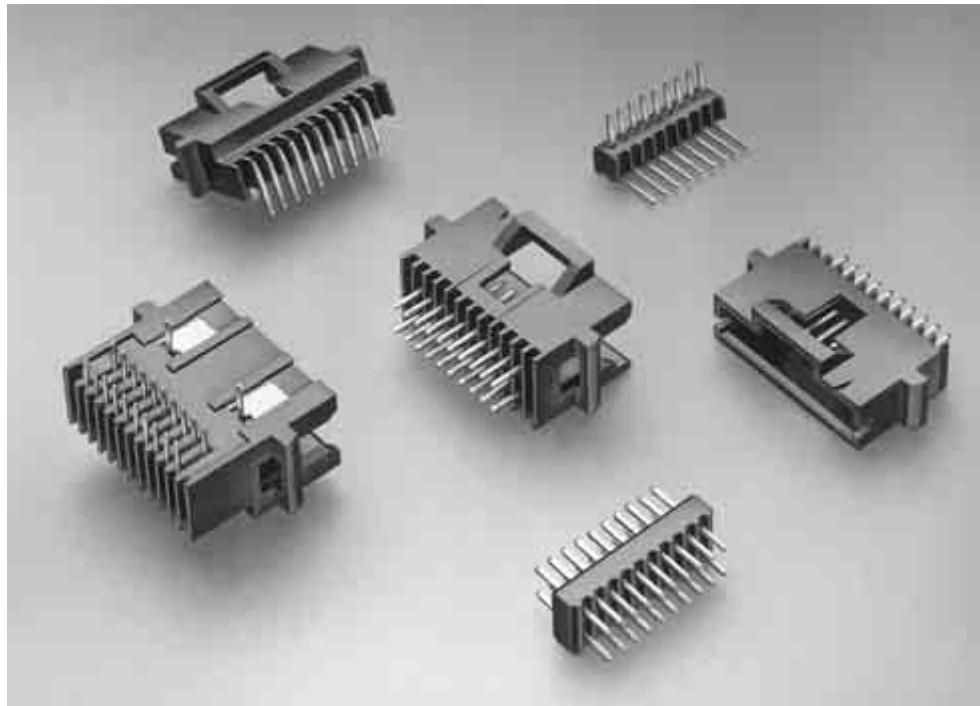

The AMPMODU System 50 interconnection system is designed to better meet industry's need for a high density interconnect system. The Board Mounted Thru-Hole Headers are available in shrouded and unshrouded versions. They are composed of single and double row post headers with .050 x .100 [1.27 x 2.54] spacing between contacts for extreme density and

efficient use of printed circuit board area. The headers are available in 4 through 50 positions, in a single row configuration, and 10 through 100 positions, in a double row design.

Board mounted post headers are available in right-angle and vertical configurations. Shrouded post headers provide polarization and alignment features for mating printed

circuit boards and cable connectors, while unshrouded headers allow close stacking of daughter cards. Housings for the headers are made of black thermoplastic material with a 94V-0 rating. The housings have stand-offs for free drainage of flux cleaning solutions.

**Thru-Hole Headers—Shrouded, .050 x .100 [1.27 x 2.54] Centerline, Board-to-Board** (Continued)

**Single Row, Right-Angle with Solder Clips**

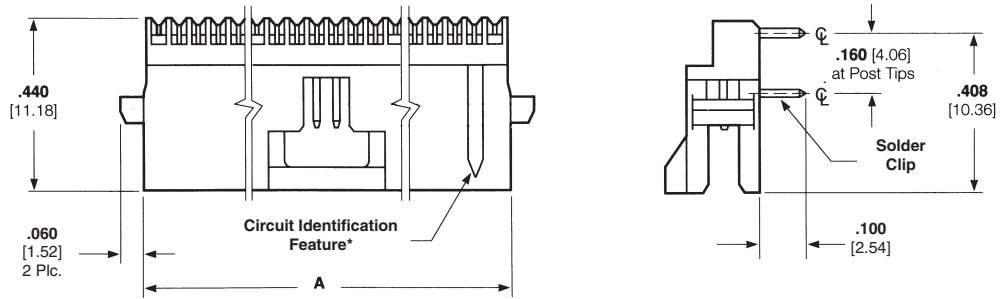

**Material and Finish**

**Housing** — Glass-filled thermoplastic, black, 94V-0 rated

**Contacts** — Copper alloy; duplex plated .000030 [0.00076] gold in mating area, .000150 [0.00381] tin on solder posts, with entire contact underplated .000050 [0.00127] nickel

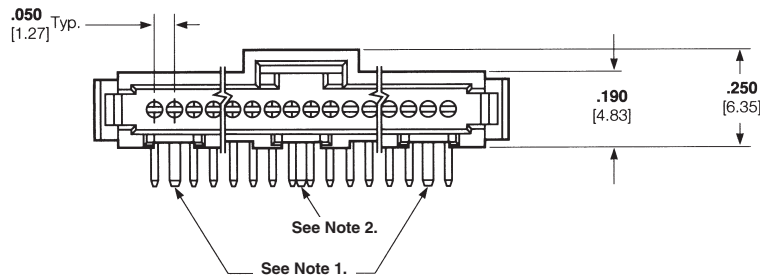

**Related Product Data**

**Performance Characteristics** — page 63

**Mateable Connectors** — pages 38, 49 & 50

**PC Board Hole Layout** — page 41

**Technical Documents** — page 64

**Product Specification** 108-1093

**Application Specification** 114-25031

| No. of Pos. | Dimension A   | Part Numbers |
|-------------|---------------|--------------|
| 4           | .330 [8.38]   | 5-104074-7   |
| 5           | .380 [9.65]   | 5-104074-2   |
| 6           | .430 [10.92]  | 5-104074-8   |
| 8           | .530 [13.46]  | 6-104074-0   |
| 10          | .630 [16.00]  | 5-104074-1   |
| 12          | .730 [18.54]  | 6-104074-1   |
| 15          | .880 [22.35]  | 5-104074-3   |
| 20          | 1.130 [28.70] | 5-104074-4   |
| 22          | 1.230 [31.24] | 6-104074-4   |
| 25          | 1.380 [35.05] | 5-104074-5   |
| 28          | 1.530 [38.86] | 7-104074-0   |
| 30          | 1.630 [41.40] | 5-104074-6   |
| 36          | 1.930 [49.02] | 6-104074-6   |
| 40          | 2.130 [54.10] | 6-104074-7   |
| 45          | 2.380 [60.45] | 6-104074-8   |
| 50          | 2.630 [66.80] | 6-104074-9   |

\*Circuit identification feature omitted on 4, 5 and 6 position headers.

**Notes:**

1. Solder Clips located as shown for 10 through 30 position headers.
2. Solder Clips located as shown for 4 through 8 and 36 through 50 position headers.

**Note:** All part numbers are RoHS compliant.

**Thru-Hole Headers—Shrouded, .050 x .100 [1.27 x 2.54] Centerline, Board-to-Board** (Continued)

**Single Row, Vertical**

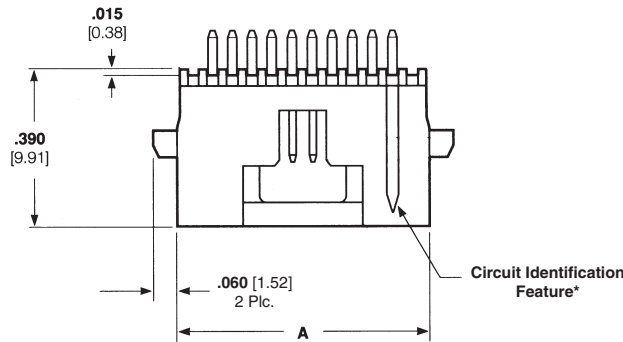
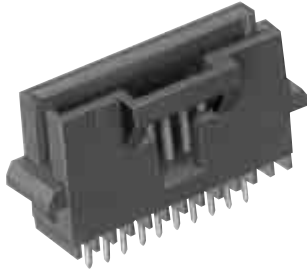

**Material and Finish**

**Housing** — Glass-filled thermoplastic, black, 94V-0 rated

**Contacts** — Copper alloy; duplex plated .000030 [0.00076] gold in mating area, .000150 [0.00381] tin on solder posts, with entire contact underplated .00050 [0.00127] nickel

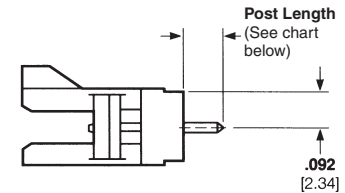
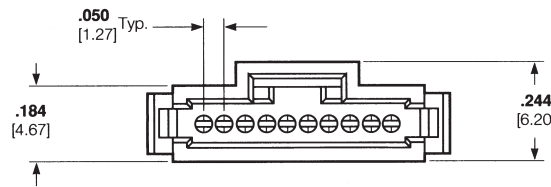

**Related Product Data**

**Performance Characteristics** — page 63

**Mateable Connectors** — pages 38, 49 & 50

**Board-to-Board Spacing** — page 63

**PC Board Hole Layout** — page 41

**Technical Documents** — page 64

**Product Specification** 108-1093

**Application Specification** 114-25031

| No. of Pos. | Dimension A   | Part Numbers |             |
|-------------|---------------|--------------|-------------|
|             |               | Post Length  |             |
|             |               | .100 [2.54]  | .145 [3.68] |
| 4           | .330 [8.38]   | 5-104071-7   | —           |
| 5           | .380 [9.65]   | 5-104071-2   | —           |
| 6           | .430 [10.92]  | 5-104071-8   | —           |
| 8           | .530 [13.46]  | 6-104071-0   | —           |
| 10          | .630 [16.00]  | 5-104071-1   | —           |
| 12          | .730 [18.54]  | 6-104071-1   | 5-104804-3  |
| 13          | .780 [19.81]  | 6-104071-2   | —           |
| 15          | .880 [22.35]  | 5-104071-3   | 5-104804-2  |
| 17          | .980 [24.89]  | 6-104071-3   | —           |
| 20          | 1.130 [28.70] | 5-104071-4   | —           |
| 22          | 1.230 [31.24] | 6-104071-4   | —           |
| 25          | 1.380 [35.05] | 5-104071-5   | —           |
| 30          | 1.630 [41.40] | 5-104071-6   | —           |
| 36          | 1.930 [49.02] | 6-104071-6   | —           |
| 40          | 2.130 [54.10] | 6-104071-7   | —           |
| 50          | 2.630 [66.80] | 6-104071-9   | —           |

\*Circuit identification feature omitted on 4, 5, and 6 position headers.

**Note:** All part numbers are RoHS compliant.

**Thru-Hole Headers—Shrouded, .050 x .100 [1.27 x 2.54] Centerline, Board-to-Board (Continued)**

**Double Row, Right-Angle with Solder Clips**

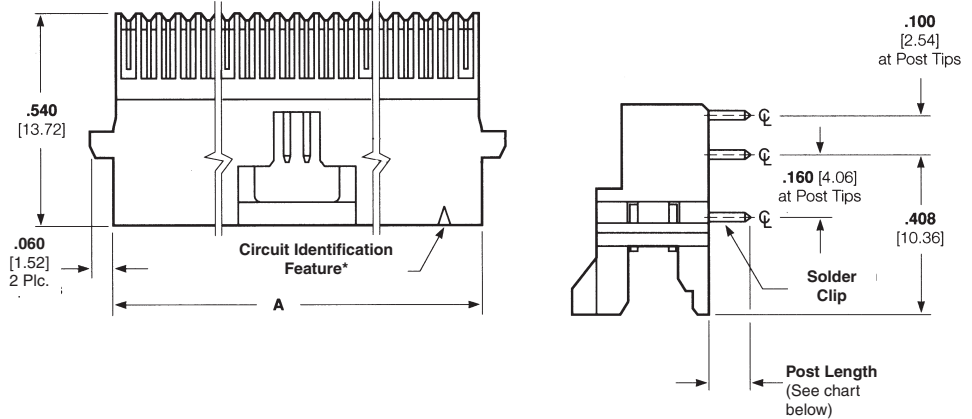
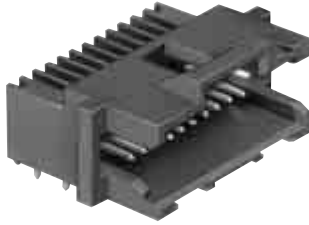

**Material and Finish**

**Housing** — Glass-filled thermoplastic, black, 94V-0 rated

**Contacts** — Copper alloy; duplex plated .000030 [0.00076] gold in mating area, .000150 [0.00381] tin on solder posts, with entire contact underplated .000050 [0.00127] nickel

**Related Product Data**

**Performance Characteristics** — page 63

**Mateable Connectors** — pages 40, 45, 51, 52, & 56

**PC Board Hole Layout** — page 41

**Technical Documents** — page 64

**Product Specification** 108-1093

**Application Specification** 114-25031

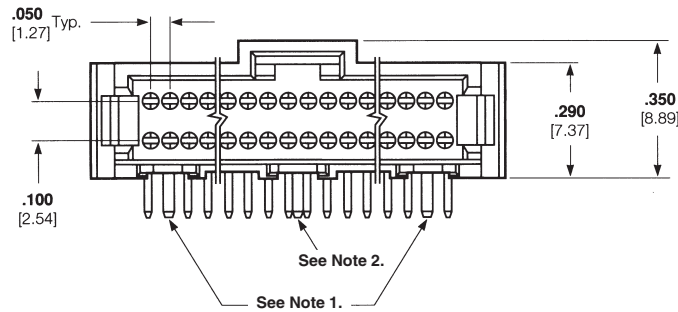

Headers, Shrouded and Unshrouded

**3**

| No. of Pos. | Dimension A   | Part Numbers |             |
|-------------|---------------|--------------|-------------|
|             |               | Post Length  |             |
|             |               | .100 [2.54]  | .145 [3.68] |
| 8           | .330 [8.32]   | 5-104069-8   | —           |
| 10          | .380 [9.65]   | 5-104069-4   | 6-104477-2  |
| 12          | .430 [10.92]  | —            | 5-104477-8  |
| 14          | .480 [12.19]  | 6-104069-0   | —           |
| 16          | .530 [13.46]  | 6-104069-1   | —           |
| 20          | .630 [16.00]  | 5-104069-1   | 5-104477-2  |
| 24          | .730 [18.54]  | 6-104069-2   | 6-104477-0  |
| 26          | .780 [19.81]  | 6-104069-3   | —           |
| 30          | .880 [22.35]  | 5-104069-5   | 5-104477-3  |
| 34          | .980 [24.89]  | 6-104069-4   | —           |
| 40          | 1.130 [28.70] | 5-104069-6   | 5-104477-4  |
| 50          | 1.380 [35.05] | 5-104069-2   | 5-104477-5  |
| 60          | 1.630 [41.40] | 5-104069-7   | 5-104477-9  |
| 68          | 1.830 [46.48] | 6-104069-8   | —           |
| 72          | 1.930 [49.02] | 6-104069-6   | 5-104477-1  |
| 80          | 2.130 [54.10] | 5-104069-3   | 5-104477-6  |
| 100         | 2.630 [66.80] | 6-104069-7   | 5-104477-7  |

\*Circuit identification feature omitted on 8, 10 and 12 position headers.

**Notes:**

1. Solder Clips located as shown for 16 through 100 position headers.
2. Solder Clips located as shown for 8 through 12 and 60 through 100 position headers.

**Note:** All part numbers are RoHS compliant.

**Thru-Hole Headers—Shrouded, .050 x .100 [1.27 x 2.54] Centerline, Board-to-Board** (Continued)

**Double Row, Vertical**

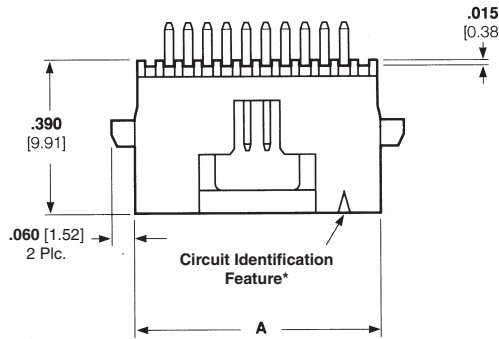
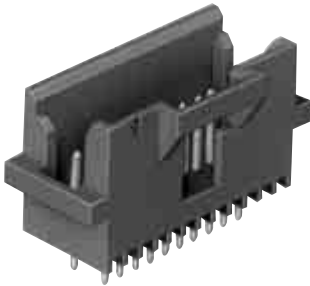

**Material and Finish**

**Housing** — Glass-filled thermoplastic, black, 94V-0 rated

**Contact** — Copper alloy; duplex plated .000030 [0.00076] gold in mating area, .000150 [0.00381] tin on solder posts, with entire contact underplated .000050 [0.00127]nickel

**Related Product Data**

**Performance Specifications** — page 63

**Mateable Connectors** — pages 40, 45, 51, 52, & 56

**Board-to-Board Spacing** — page 63

**PC Board Hole Layout** — page 41

**Technical Documents** — page 64

**Product Specification** 108-1093

**Application Specification** 114-25031

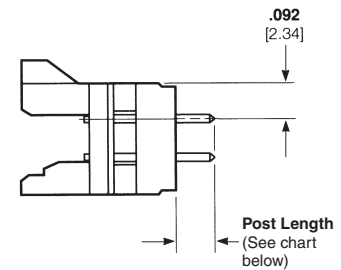
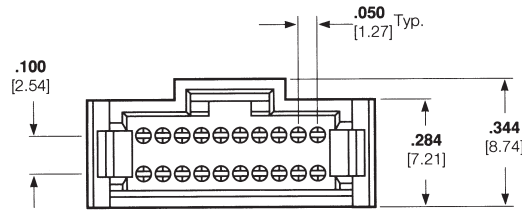

| No. of Pos. | Dimension A   | Part Numbers |             |
|-------------|---------------|--------------|-------------|
|             |               | Post Length  |             |
|             |               | .100 [2.54]  | .145 [3.68] |
| 10          | .380 [9.65]   | 5-104068-2   | —           |
| 12          | .430 [10.92]  | 5-104068-8   | —           |
| 14          | .480 [12.19]  | 5-104068-9   | —           |
| 16          | .530 [13.46]  | 6-104068-0   | 5-104666-9  |
| 20          | .630 [16.00]  | 5-104068-1   | 5-104666-1  |
| 24          | .730 [18.54]  | 6-104068-1   | 6-104666-0  |
| 26          | .780 [19.81]  | 6-104068-2   | —           |
| 30          | .880 [22.35]  | 5-104068-3   | 5-104666-2  |
| 34          | .980 [24.89]  | 6-104068-3   | —           |
| 40          | 1.130 [28.70] | 5-104068-4   | 5-104666-3  |
| 44          | 1.230 [31.24] | 6-104068-4   | —           |
| 50          | 1.380 [35.05] | 5-104068-5   | 5-104666-4  |
| 60          | 1.630 [41.40] | 5-104068-6   | 5-104666-7  |
| 68          | 1.830 [46.48] | 6-104068-8   | 5-104666-8  |
| 72          | 1.930 [49.02] | 6-104068-5   | —           |
| 80          | 2.130 [54.10] | 6-104068-6   | 5-104666-5  |
| 100         | 2.630 [66.80] | 6-104068-7   | 5-104666-6  |

\*Circuit identification feature omitted on 10 and 12 position headers.

**Note:** All part numbers are RoHS compliant.

Headers, Shrouded and Unshrouded

3

**Thru-Hole Headers—Shrouded, .050 x .100 [1.27 x 2.54] Centerline, Board-to-Board** (Continued)

**Double Row, Vertical With Card Slots**

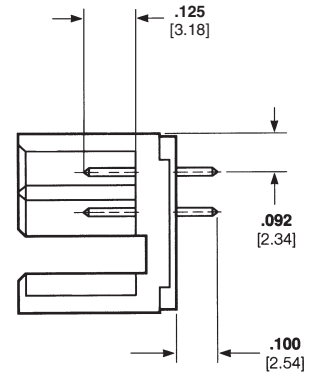
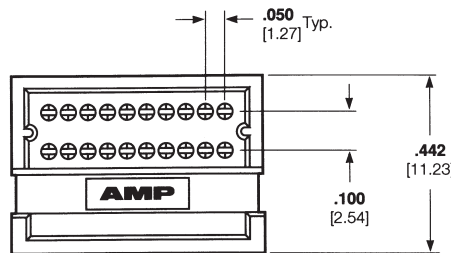
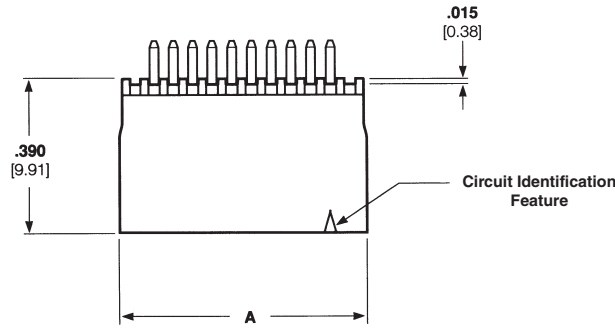
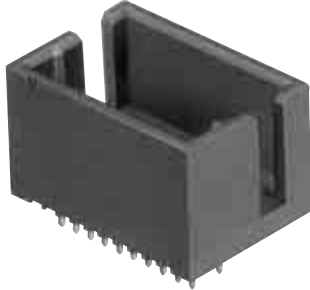

**Material and Finish**

**Housing** — Glass-filled thermoplastic, black, 94V-0 rated

**Contacts** — Copper alloy; duplex plated .000030 [0.00076] gold in mating area, .000150 [0.00381] tin on solder posts, with entire contact underplated .000050 [0.00127] nickel

**Related Product Data**

**Performance Specifications** — page 63

**Mateable Connectors** — page 39

**PC Board Hole Layout** — page 41

**Technical Documents** — page 64

**Product Specification** 108-1093

**Application Specification** 114-25031

| No. of Pos. | Dimension A   | Part Numbers |
|-------------|---------------|--------------|
| 10          | .394 [10.01]  | 5-104076-5   |
| 20          | .644 [16.36]  | 5-104076-1   |
| 30          | .894 [22.71]  | 5-104076-6   |
| 40          | 1.144 [29.06] | 5-104076-3   |
| 50          | 1.394 [35.41] | 5-104076-7   |
| 60          | 1.644 [41.76] | 5-104076-2   |
| 80          | 2.144 [54.46] | 5-104076-4   |
| 100         | 2.644 [67.16] | 5-104076-8   |

**Note:** All part numbers are RoHS compliant.

**Thru-Hole Headers—Unshrouded, .050 x .100 [1.27 x 2.54] Centerline, Board-to-Board**

**Single Row, Right-Angle**

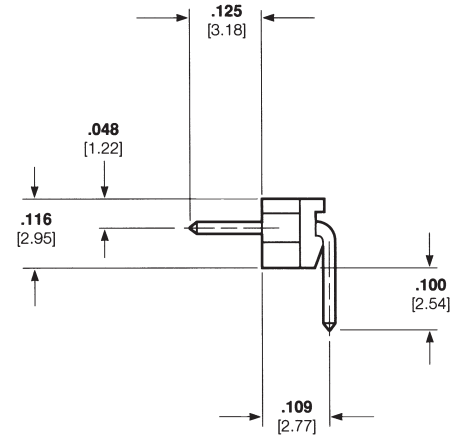
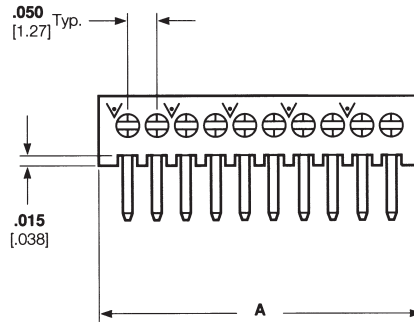
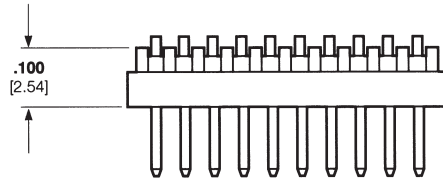
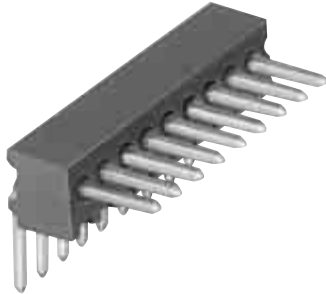

**Material and Finish**

**Housing** — Glass-filled thermoplastic, black, 94V-0 rated

**Contacts** — Copper alloy; duplex plated .000030 [0.00076] gold in mating area, .000150 [0.00381] tin on solder posts, with entire contact underplated .000050 [0.00127] nickel

**Related Product Data**

**Performance Characteristics** — page 63

**Mateable Connectors** — pages 37, 38, 49, & 50

**PC Board Hole Layout** — page 41

**Technical Documents** — page 64

**Product Specification** 108-1093

**Application Specification** 114-25031

| No. of Pos. | Dimension A   | Part Numbers |
|-------------|---------------|--------------|
| 4           | .215 [5.46]   | 5-104186-1   |
| 8           | .415 [10.54]  | 5-104186-5   |
| 12          | .615 [15.62]  | 5-104186-7   |
| 15          | .765 [19.43]  | 5-104186-9   |
| 17          | .865 [21.97]  | 6-104186-0   |
| 20          | 1.015 [25.78] | 6-104186-1   |
| 25          | 1.265 [32.13] | 6-104186-3   |
| 30          | 1.515 [38.48] | 6-104186-5   |
| 31          | 1.565 [39.75] | 7-104186-0   |
| 40          | 2.015 [51.18] | 6-104186-7   |

**Note:** All part numbers are RoHS compliant.



**Thru-Hole Headers—Unshrouded, .050 x .100 [1.27 x 2.54] Centerline, Board-to-Board** (Continued)

**Single Row, Vertical**

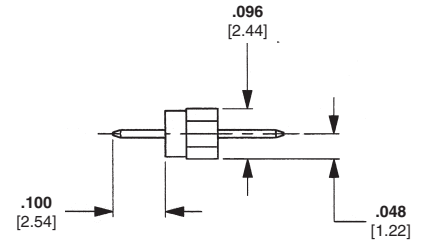
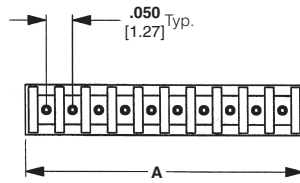
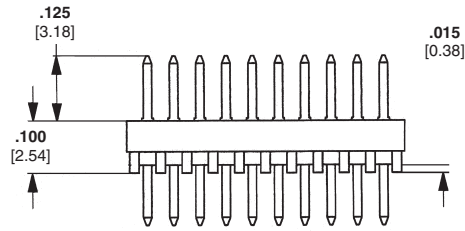
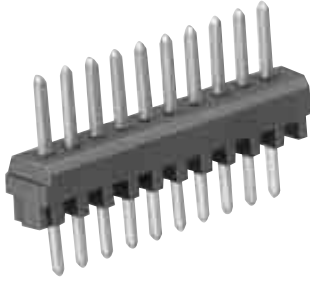

**Material and Finish**

**Housing** — Glass-filled thermoplastic, black, 94V-0 rated

**Contacts** — Copper alloy; duplex plated .000030 [0.00076] gold in mating area, .000150 [0.00381] tin on solder posts, with entire contact underplated .000050 [0.00127] nickel

**Related Product Data**

**Performance Specifications** — page 63

**Mateable Connectors** — pages 37, 38, 49, & 50

**Board-to-Board Spacing** — page 63

**PC Board Hole Layout** — page 41

**Technical Documents** — page 64

**Product Specification** 108-1093

**Application Specification** 114-25031

| No. of Pos. | Dimension A   | Part Numbers |
|-------------|---------------|--------------|
| 4           | .215 [5.46]   | 5-104178-1   |
| 6           | .315 [8.00]   | 5-104178-3   |
| 8           | .415 [10.54]  | 5-104178-5   |
| 10          | .515 [13.08]  | 5-104178-6   |
| 20          | 1.015 [25.78] | 6-104178-1   |
| 25          | 1.265 [32.13] | 6-104178-3   |

**Note:** All part numbers are RoHS compliant.

**Thru-Hole Headers—Unshrouded, .050 x .100 [1.27 x 2.54] Centerline,  
Board-to-Board** (Continued)

**Double Row, Right-Angle**

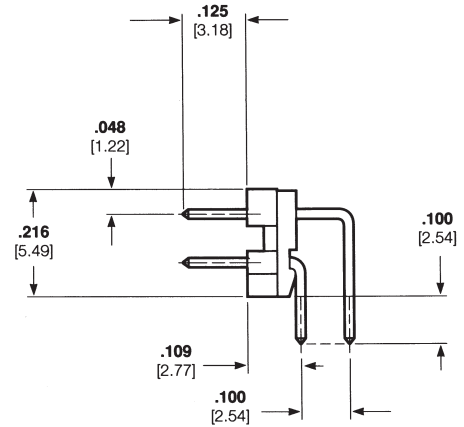
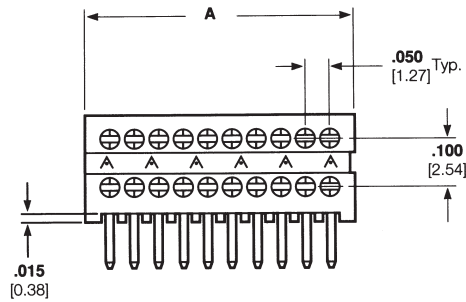
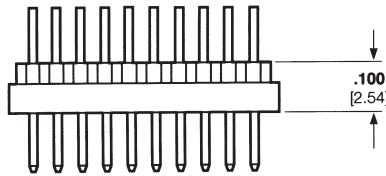
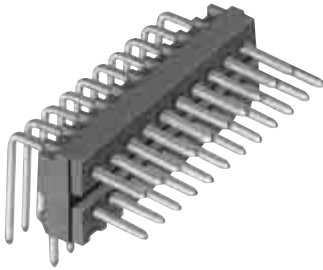

**Material and Finish**

**Housing** — Glass-filled thermoplastic, black, 94V-0 rated

**Contacts** — Copper alloy; duplex plated .000030 [0.00076] gold in mating area, .000150 [0.00381] tin on solder posts, with entire contact underplated .000050 [0.00127] nickel

**Related Product Data**

**Performance Specifications** — page 63

**Mateable Connectors** — pages 39, 40, 45, 51 & 52

**PC Board Hole Layout** — page 41

**Technical Documents** — page 64

**Product Specification** 108-1093

**Application Specification** 114-25031

| No. of Pos. | Dimension A   | Part Numbers |
|-------------|---------------|--------------|
| 10          | .265 [6.73]   | 5-104118-3   |
| 20          | .515 [13.08]  | 5-104118-7   |
| 30          | .765 [19.43]  | 6-104118-0   |
| 40          | 1.015 [25.78] | 6-104118-2   |
| 50          | 1.265 [32.13] | 5-104118-1   |
| 60          | 1.515 [38.48] | 6-104118-4   |
| 80          | 2.015 [51.18] | 6-104118-6   |
| 100         | 2.515 [63.88] | 6-104118-7   |

**Note:** All part numbers are RoHS compliant.

3 Headers, Shrouded and Unshrouded

**Thru-Hole Headers—Unshrouded, .050 x .100 [1.27 x 2.54] Centerline, Board-to-Board** (Continued)

**Double Row, Vertical**

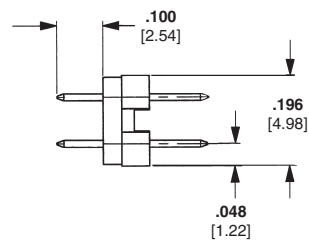
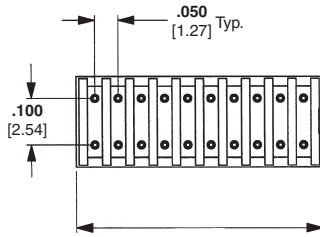
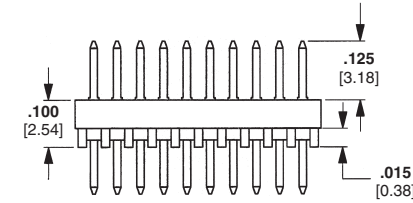
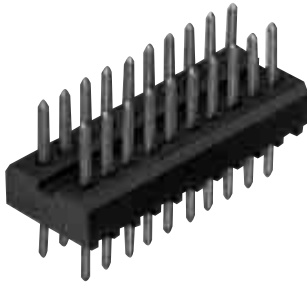

**Material and Finish**

**Housing** — Glass-filled thermoplastic, black, 94V-0 rated

**Contacts** — Copper alloy; duplex plated .000030 [0.00076] gold in mating area, .000150 [0.00381] tin on solder posts, with entire contact underplated .000050 [0.00127] nickel

**Related Product Data**

**Performance Characteristics** — page 63

**Mateable Connectors** — pages 39, 40, 45, 51, & 52

**Board-to-Board Spacing** — page 63

**PC Board Hole Layout** — page 42

**Technical Documents** — page 64

**Product Specification** 108-1093

**Application Specification** 114-25031

| No. of Pos. | Dimension A   | Part Numbers |
|-------------|---------------|--------------|
| 8           | .215 [5.46]   | 5-103916-3   |
| 20          | .515 [13.08]  | 5-103916-2   |
| 30          | .765 [19.43]  | 5-103916-9   |
| 36          | .915 [23.24]  | 6-103916-8   |
| 40          | 1.015 [25.78] | 6-103916-1   |
| 50          | 1.265 [32.13] | 6-103916-3   |
| 60          | 1.515 [38.48] | 6-103916-4   |
| 80          | 2.015 [51.18] | 6-103916-6   |
| 100         | 2.515 [63.88] | 6-103916-7   |

**Note:** All part numbers are RoHS compliant.

## Thru-Hole Receptacles, .050 x .100 [1.27 x 2.54] Centerline, Board-to-Board

### Product Facts

- High density; contacts spaced on .050 x .100 [1.27 x 2.54] centers
- Right-angle and vertical styles
- Single row; select sizes 5 thru 50 positions
- Double row; select sizes 10 thru 100 positions
- Contacts are selectively plated with gold
- Stand-offs for removal of solder flux

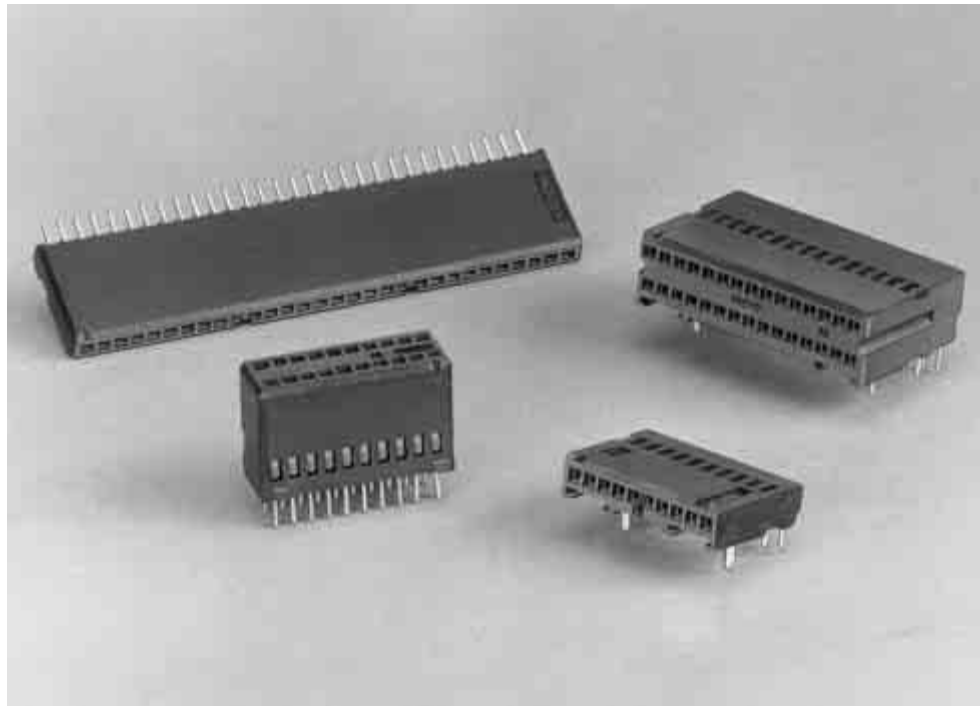

The AMPMODU System 50 thru-hole receptacles offer a wide variety of high density board-to-board connectors. The .050 [1.27] spacing between each contact provides an extremely dense interconnect package and results in a more efficient use of the printed circuit board space.

AMPMODU System 50 thru-hole receptacles are available in right-angle and vertical configurations and are composed of single and double row versions. The single row versions are available in select sizes of 5 thru 50 positions and double row in positions from 10 thru 100.

Receptacle contacts and mating .015 [0.38] square posts are formed from high conductivity copper alloy and are selectively plated with gold for higher performance and reliability. The receptacle housings are made of black thermoplastic, with a 94V-0 rating to withstand high temperatures of reflow soldering and incorporate stand-offs for free drainage of flux cleaning solutions.

**Thru-Hole Receptacles, .050 x .100 [1.27 x 2.54] Centerline, Board-to-Board** (Continued)

**Single Row, Right-Angle With Solder Clips**

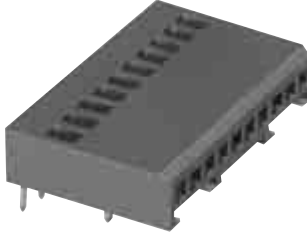

**Material and Finish**

**Housing** — Glass-filled thermoplastic, black, 94V-0 rated

**Contacts** — Copper alloy; duplex plated .000030 [0.00076] gold in mating area, .000150 [0.00381] tin on solder posts, with entire contact underplated .000050 [0.00127] nickel

**Related Product Data**

**Performance Specifications** — page 63

**Mateable Connectors** — pages 32 & 33

**PC Board Hole Layout** — page 41

**Technical Documents** — page 64

**Product Specification** 108-1093

**Application Specification** 114-25031

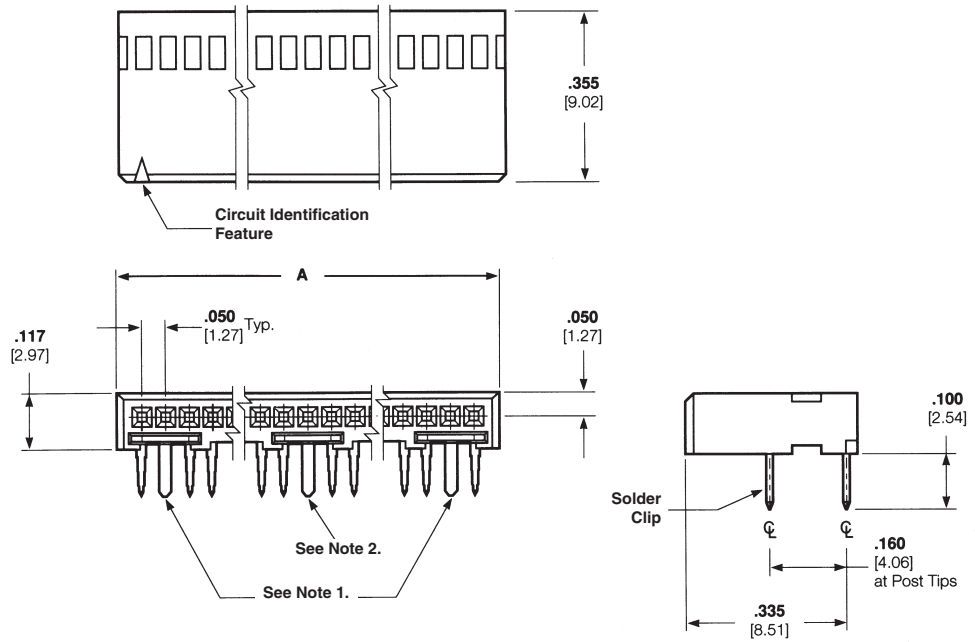

| No. of Pos. | Dimension A   | Part Numbers |
|-------------|---------------|--------------|
| 10          | .544 [13.82]  | 5-104196-2   |
| 15          | .794 [20.17]  | 5-104196-4   |
| 20          | 1.044 [26.52] | 5-104196-5   |

**Notes:**

1. Solder Clips located as shown for 10 through 25 position receptacles.
2. Solder Clips located as shown for 5 and 25 position receptacles.

**Note:** All part numbers are RoHS compliant.

**Thru-Hole Receptacles, .050 x .100 [1.27 x 2.54] Centerline,**  
**Board-to-Board** (Continued)

**Single Row, Vertical**

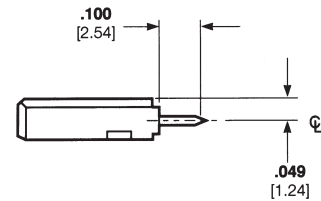
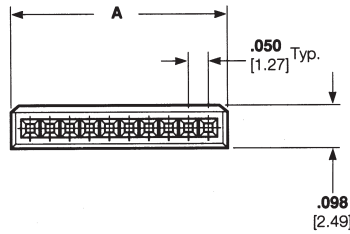
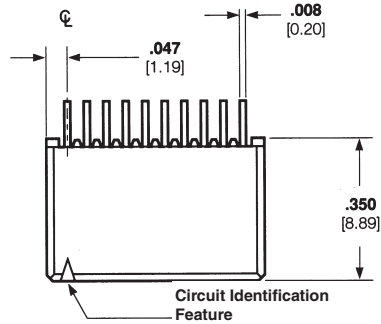
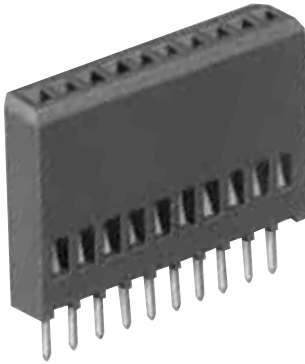

**Material and Finish**

**Housing** — Glass-filled thermoplastic, black, 94V-0 rated

**Contacts** — Copper alloy; duplex plated .000030 [0.00076] gold in mating area, .000150 [0.00381] tin on solder posts, with entire contact underplated .000050 [0.00127] nickel

**Related Product Data**

**Performance Specifications** — page 63

**Mateable Connectors** — pages 27, 28, 32, & 33

**Board-to-Board Spacing** — page 63

**PC Board Hole Layout** — page 41

**Technical Documents** — page 64

**Product Specification** 108-1093

**Application Specification**  
114-25031

| No. of Pos. | Dimension A   | Part Numbers |
|-------------|---------------|--------------|
| 10          | .544 [13.82]  | 5-104192-2   |
| 12          | .644 [16.35]  | 5-104192-3   |
| 15          | .794 [20.17]  | 5-104192-4   |
| 20          | 1.044 [26.52] | 5-104192-5   |
| 30          | 1.544 [39.22] | 5-104192-7   |

**Note:** All part numbers are RoHS compliant.

**Thru-Hole Receptacles, .050 x .100 [1.27 x 2.54] Centerline,  
Board-to-Board (Continued)**

**Double Row, Right-Angle**

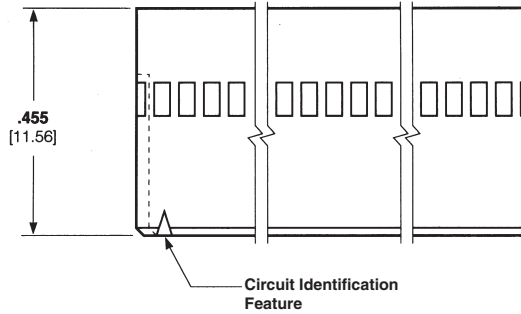

**Material and Finish**

**Housing** — Glass-filled thermoplastic, black, 94V-0 rated

**Contacts** — Copper alloy; duplex plated .000030 [0.00076] gold in mating area, .000150 [0.00381] tin on solder posts, with entire contact underplated .000050 [0.00127] nickel

**Related Product Data**

**Performance Characteristics** — page 63

**Mateable Connectors** — pages 31, 34 & 35

**PC Board Hole Layout** — page 41

**Technical Documents** — page 64

**Product Specification** 108-1093

**Application Specification**  
114-25031

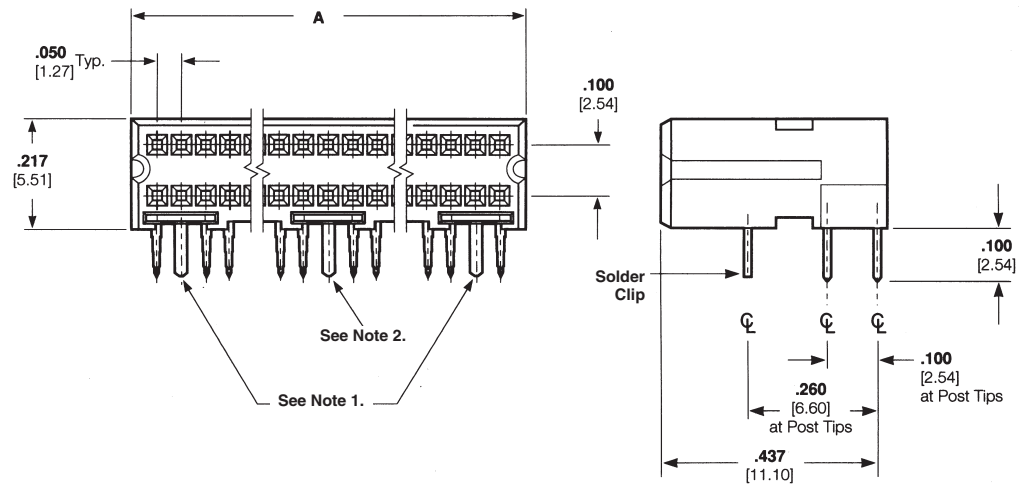

| No. of Pos. | Dimension A     | Part Numbers |
|-------------|-----------------|--------------|
| 10          | $.294$ [7.47]   | 5-103911-1   |
| 20          | $.544$ [13.82]  | 5-103911-2   |
| 30          | $.794$ [20.17]  | 5-103911-7   |
| 40          | $1.044$ [26.52] | 5-103911-5   |
| 50          | $1.294$ [32.87] | 5-103911-4   |
| 60          | $1.544$ [39.22] | 5-103911-3   |
| 80          | $2.044$ [51.92] | 5-103911-6   |
| 100         | $2.544$ [64.62] | 5-103911-8   |

**Notes:**

1. Solder Clips located as shown for 20 through 100 position receptacles.
2. Solder Clips located as shown for 10, 60, 80 and 100 position receptacles.

**Note:** All part numbers are RoHS compliant.

**Thru-Hole Receptacles, .050 x .100 [1.27 x 2.54] Centerline, Board-to-Board** (Continued)

**Double Row, Vertical**

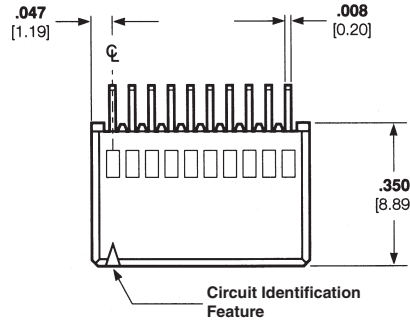
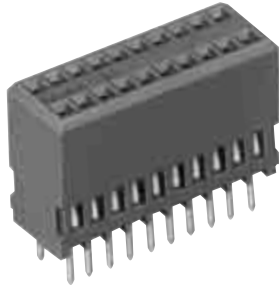

**Material and Finish**

**Housing** — Glass-filled thermoplastic, black, 94V-0 rated

**Contacts** — Copper alloy; duplex plated .000030 [0.00076] gold in mating area, .000150 [0.00381] tin on solder posts, with entire contact underplated .000050 [0.00127] nickel

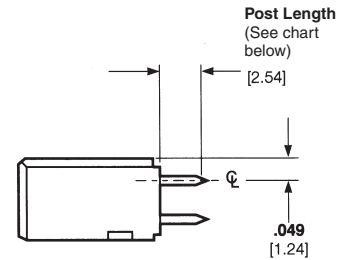
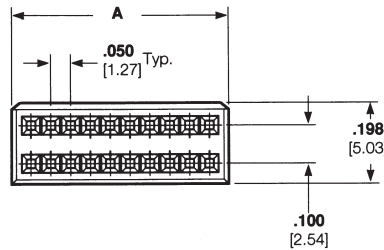

**Related Product Data**

**Performance Specifications** — page 63

**Mateable Connectors** — pages 29, 30, 34, 35 & 44

**Board-to-Board Spacing** — page 63

**PC Board Hole Layout** — page 41

**Technical Documents** — page 64

**Product Specification** 108-1093

**Application Specification**

114-25031

| No. of Pos. | Dimension A   | Part Numbers Post Length |             |
|-------------|---------------|--------------------------|-------------|
|             |               | .100 [2.54]              | .145 [3.68] |
| 10          | .294 [7.47]   | 5-104078-3               | —           |
| 20          | .544 [13.82]  | 5-104078-1               | —           |
| 24          | .644 [16.36]  | 5-104078-9               | —           |
| 30          | .794 [20.17]  | 5-104078-4               | —           |
| 34          | .894 [22.71]  | 6-104078-0               | —           |
| 40          | 1.044 [26.52] | 5-104078-2               | —           |
| 50          | 1.294 [32.87] | 5-104078-5               | 5-104744-7  |
| 60          | 1.544 [39.22] | 5-104078-6               | —           |
| 68          | 1.744 [44.30] | 6-104078-3               | —           |
| 80          | 2.044 [51.92] | 5-104078-7               | 5-104744-4  |
| 100         | 2.544 [64.62] | 5-104078-8               | 5-104744-5  |

**Note:** All part numbers are RoHS compliant.

Receptacles  
3



**Recommended PC Board Hole Layouts, Thru-Hole Board-to-Board Connectors**

**Single Row, Right-Angle with Solder Clips**

**Note:** Consult Tyco Electronics for customer drawings detailing tolerances.

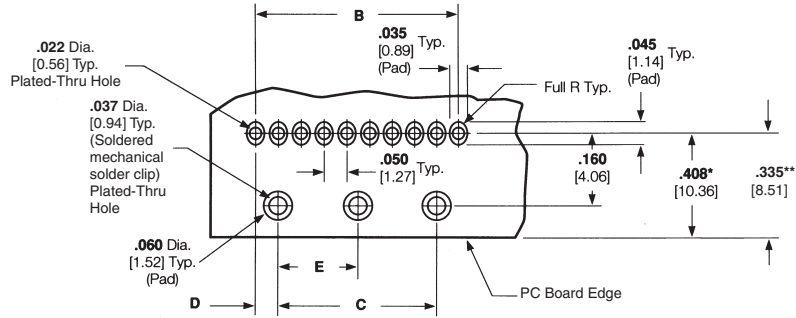

\* This dimension is for Shrouded, Single Row Right-Angle Headers only.

\*\* This dimension is for Single Row Right-Angle Receptacles only.

| No. of Pos. | Dimensions    |               |             |               |
|-------------|---------------|---------------|-------------|---------------|
|             | B             | C             | D           | E             |
| 4           | .150 [3.81]   | —             | .075 [1.91] | —             |
| 5           | .200 [5.08]   | —             | .100 [2.54] | —             |
| 6           | .250 [6.35]   | —             | .125 [3.18] | —             |
| 8           | .350 [8.89]   | —             | .175 [4.45] | —             |
| 10          | .450 [11.43]  | .350 [8.89]   | .050 [1.27] | —             |
| 12          | .550 [13.97]  | .450 [11.43]  | .050 [1.27] | —             |
| 15          | .700 [17.78]  | .600 [15.24]  | .050 [1.27] | —             |
| 20          | .950 [24.13]  | .850 [21.59]  | .050 [1.27] | —             |
| 22          | 1.050 [26.67] | .950 [24.13]  | .050 [1.27] | —             |
| 25          | 1.200 [30.48] | 1.100 [27.94] | .050 [1.27] | —             |
| 28          | 1.350 [34.29] | 1.250 [31.75] | .050 [1.27] | .625 [15.88]  |
| 30          | 1.450 [36.83] | 1.350 [34.29] | .050 [1.27] | .675 [17.15]  |
| 36          | 1.750 [44.45] | 1.650 [41.91] | .050 [1.27] | .825 [20.96]  |
| 40          | 1.950 [49.53] | 1.850 [46.99] | .050 [1.27] | .925 [23.50]  |
| 45          | 2.200 [55.88] | 2.100 [53.34] | .050 [1.27] | 1.050 [26.67] |
| 50          | 2.450 [62.23] | 2.350 [59.69] | .050 [1.27] | 1.175 [29.85] |

**Double Row, Right-Angle with Solder Clips**

**Note:** Consult Tyco Electronics for customer drawings detailing tolerances.

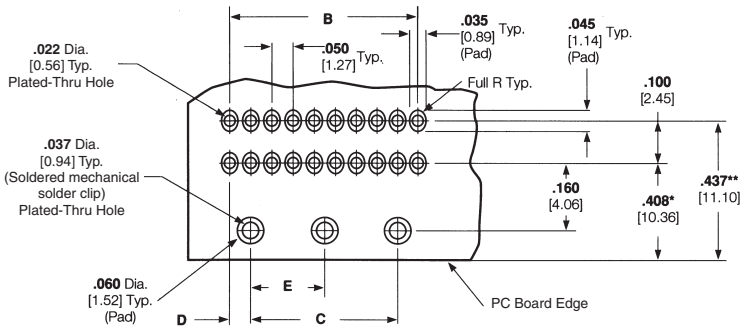

\* This dimension is for Shrouded, Double Row Right-Angle Headers only.

\*\* This dimension is for Double Row Right-Angle Receptacles only.

| No. of Pos. | Dimensions    |               |             |               |
|-------------|---------------|---------------|-------------|---------------|
|             | B             | C             | D           | E             |
| 10          | .200 [5.08]   | —             | .100 [2.54] | —             |
| 20          | .450 [11.43]  | .350 [8.89]   | .050 [1.27] | —             |
| 24          | .550 [13.97]  | .450 [11.43]  | .050 [1.27] | —             |
| 26          | .600 [15.24]  | .500 [12.70]  | .050 [1.27] | —             |
| 30          | .700 [17.78]  | .600 [15.24]  | .050 [1.27] | —             |
| 34          | .800 [20.32]  | .700 [17.78]  | .050 [1.27] | —             |
| 40          | .950 [24.13]  | .850 [21.59]  | .050 [1.27] | —             |
| 50          | 1.200 [30.48] | 1.100 [27.94] | .050 [1.27] | —             |
| 60          | 1.450 [36.83] | 1.350 [34.29] | .050 [1.27] | .675 [17.15]  |
| 68          | 1.650 [41.91] | 1.550 [39.37] | .050 [1.27] | .775 [19.69]  |
| 72          | 1.750 [44.45] | 1.650 [41.91] | .050 [1.27] | .825 [20.96]  |
| 80          | 1.950 [49.53] | 1.850 [46.99] | .050 [1.27] | .925 [23.50]  |
| 100         | 2.450 [62.23] | 2.350 [59.69] | .050 [1.27] | 1.175 [29.85] |

## Recommended PC Board Hole Layouts, Thru-Hole Board-to-Board Connectors (Continued)

### Single Row Without Solder Clips

**Note:** Consult Tyco Electronics for customer drawings detailing tolerances.

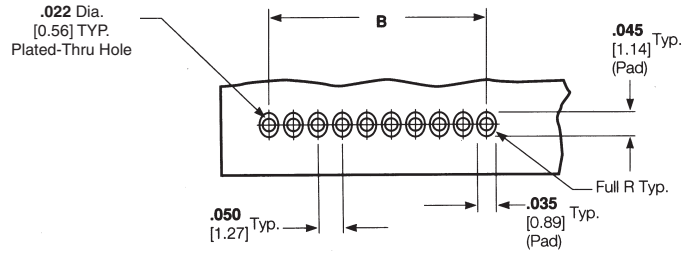

| No. of Pos. | Dimension B  |
|-------------|--------------|
| 4           | .150 [3.81]  |
| 5           | .200 [5.08]  |
| 6           | .250 [6.35]  |
| 8           | .350 [8.89]  |
| 10          | .450 [11.43] |
| 12          | .550 [13.97] |
| 13          | .600 [15.24] |
| 15          | .700 [17.78] |

| No. of Pos. | Dimension B   |
|-------------|---------------|
| 17          | .800 [20.32]  |
| 20          | .950 [24.13]  |
| 22          | 1.050 [26.67] |
| 25          | 1.200 [30.48] |
| 30          | 1.450 [36.83] |
| 31          | 1.500 [38.10] |
| 36          | 1.750 [44.45] |
| 40          | 1.950 [49.53] |
| 50          | 2.450 [62.23] |

### Double Row Without Solder Clips

**Note:** Consult Tyco Electronics for customer drawings detailing tolerances.

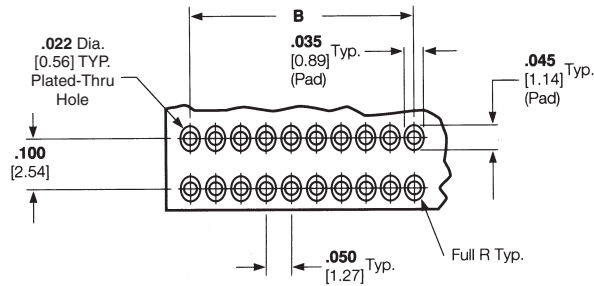

| No. of Pos. | Dimension B  |
|-------------|--------------|
| 8           | .150 [3.81]  |
| 10          | .200 [5.08]  |
| 12          | .250 [6.35]  |
| 14          | .300 [7.62]  |
| 16          | .350 [8.89]  |
| 20          | .450 [11.43] |
| 24          | .550 [13.97] |
| 26          | .600 [15.24] |
| 30          | .700 [17.78] |
| 34          | .800 [20.32] |

| No. of Pos. | Dimension B   |
|-------------|---------------|
| 36          | .850 [21.59]  |
| 40          | .950 [24.13]  |
| 44          | 1.050 [26.67] |
| 50          | 1.200 [30.48] |
| 60          | 1.450 [36.83] |
| 68          | 1.650 [41.91] |
| 72          | 1.750 [44.45] |
| 80          | 1.950 [49.53] |
| 100         | 2.450 [62.23] |

## Surface-Mount Connectors, .050 x .100 [1.27 x 2.54] Centerline, Board-to-Board

### Product Facts

- Surface-mount option for parallel board-to-board applications; completely intermateable with AMPMODU System 50 thru-hole board-to-board and cable-to-board systems
- Double row, vertical, shrouded header and receptacle assemblies
- Available in select sizes from 10 through 100 positions
- High Density; contacts spaced on .050 x .100 [1.27 x 2.54] centers; compact footprint
- Compatible with standard surface-mount processes
- Stand-offs for free drainage of flux cleaning solutions; visible solder joints for easy inspection
- Simple, low insertion-force holddown for process retention and long-term strain relief for solder joints
- Available in tape and reel packaging (with vacuum covers) for automatic placement.

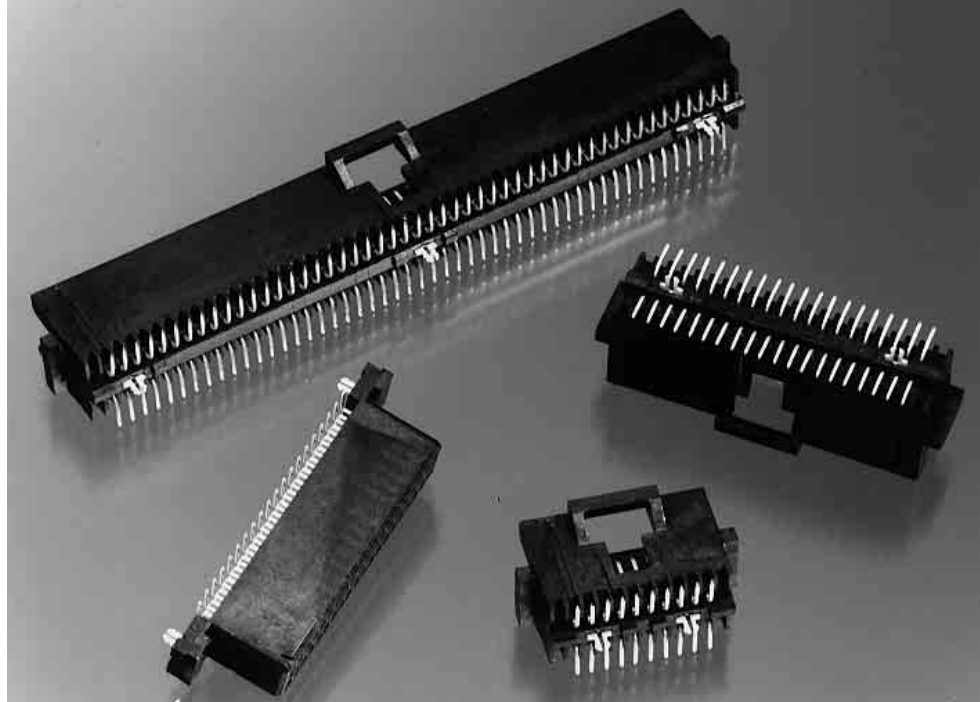

The high-density surface-mount connector is another mounting option in the AMPMODU System 50 connector family.

This surface-mount system is fully intermateable with the AMPMODU System 50 thru-hole and cable-to-board connectors.

Additionally, the design of the mating interface has not been changed, maintaining the same high reliability as the thru-hole product.

The surface-mount system includes double row, vertical, shrouded header and receptacle assemblies in select sizes from 10 through 100 positions. It meets the tight dimensional requirements of surface-mount technology. The simple, low insertion-force holddown provides both processing retention and long-term strain relief for the solder joints in the headers and receptacles.

## Surface-Mount Headers, .050 x .100 [1.27 x 2.54] Centerline, Board-to-Board

### Double Row, Vertical

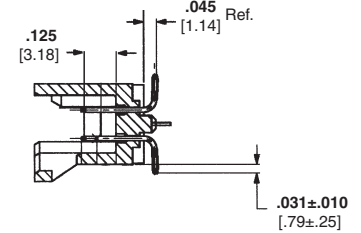
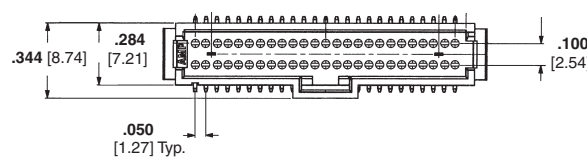
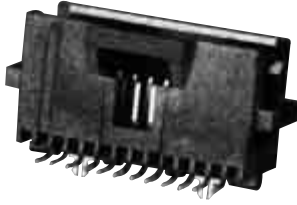

### Material and Finish

**Housing** — Glass-filled thermoplastic, black, 94V-0 rated

**Contacts** — Copper alloy; duplex plated .000030 [0.00076] gold in mating area, .000150 [0.00381] tin on solder tail, with entire contact under-plated .000050 [0.00127] nickel

**Holddown** — Copper alloy, plated .000150 [0.00381] tin over .000050 [0.00127] nickel

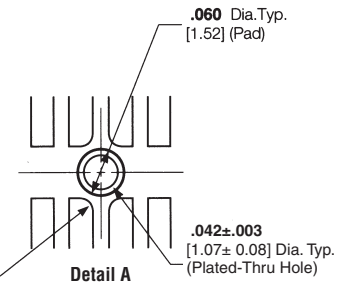
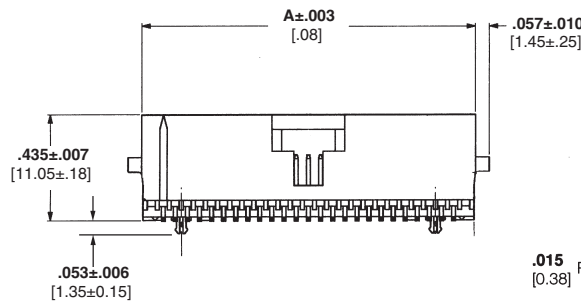

### Related Product Data

**Performance Characteristics** — page 63

**Mateable Connectors** — pages 40, 45, 51, 52, & 56

**Board-to-Board Spacing** — page 63

**Technical Documents** — page 64

**Product Specification** 108-1093

**Application Specification** 114-25035

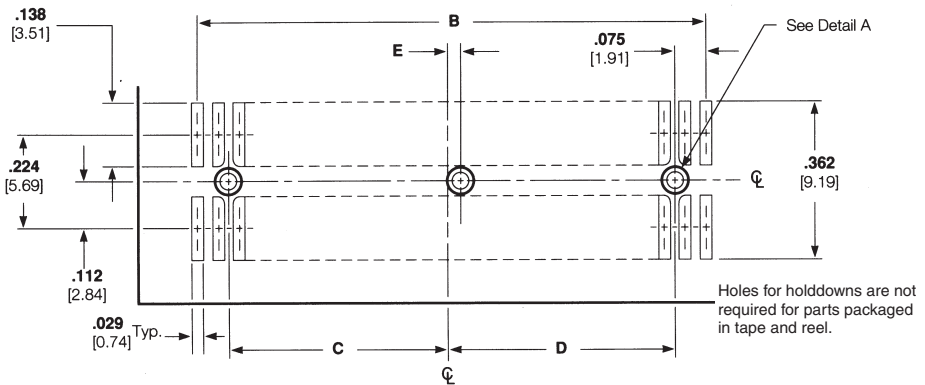

Recommended PC Board Layout

| No. of Pos. | Dimensions    |               |               |               |             | Part Numbers |                     |
|-------------|---------------|---------------|---------------|---------------|-------------|--------------|---------------------|
|             | A             | B             | C             | D             | E           | Pkg in Tube  | Pkg in Tape & Reel* |
| 10          | .380 [9.65]   | .200 [5.08]   | —             | .025 [0.64]   | —           | 5-104549-1   | 5-147377-1          |
| 12          | .430 [10.92]  | .250 [6.35]   | —             | —             | —           | 6-104549-1   | —                   |
| 20          | .630 [16.00]  | .450 [11.43]  | .150 [3.81]   | .150 [3.81]   | —           | 5-104549-2   | 5-147377-2          |
| 24          | .730 [18.54]  | .550 [13.97]  | .200 [5.08]   | .200 [5.08]   | —           | 5-104549-3   | 5-147377-9          |
| 30          | .880 [22.35]  | .700 [17.78]  | .275 [6.99]   | .275 [6.99]   | —           | 5-104549-5   | 5-147377-3          |
| 40          | 1.130 [28.70] | .950 [24.13]  | .400 [10.16]  | .400 [10.16]  | —           | 5-104549-6   | 5-147377-4          |
| 50          | 1.380 [35.05] | 1.200 [30.48] | .525 [13.34]  | .525 [13.34]  | .025 [0.64] | 5-104549-7   | 5-147377-5          |
| 60          | 1.630 [41.40] | 1.450 [36.83] | .650 [16.51]  | .650 [16.51]  | .000        | 5-104549-8   | 5-147377-6          |
| 80          | 2.130 [54.10] | 1.950 [49.53] | .900 [22.86]  | .900 [22.86]  | .000        | 5-104549-9   | 5-147377-7          |
| 100         | 2.630 [66.80] | 2.450 [62.23] | 1.150 [29.21] | 1.150 [29.21] | .000        | 6-104549-0   | 5-147377-8          |

\*Parts packaged in tape and reel are without hold downs and include a vacuum pick and place cover

**Note:** All part numbers are RoHS compliant.

**Surface-Mount Receptacles, .050 x .100 [1.27 x 2.54] Centerline, Board-to-Board**

**Double Row, Vertical**

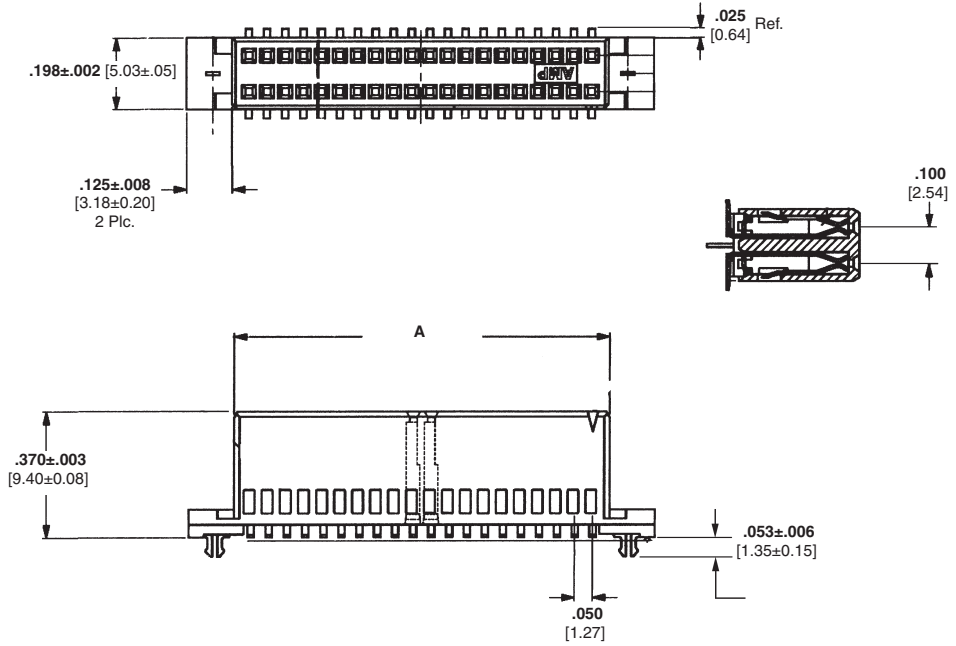

**Material and Finish**

**Housing** — Glass-filled thermoplastic, black, 94V-0 rated

**Contacts** — Phosphor bronze; duplex plated .000030 [0.00076] gold in mating area, .000150 [0.00381] tin on solder tail, with entire contact underplated .000050 [0.00127] nickel

**Holddown** — Copper alloy; duplex plated .000150 [0.00381] tin over .000050 [0.00127] nickel

**Related Product Data**

**Performance Characteristics** — page 63

**Mateable Connectors** — pages 29, 30, 34, 35 & 44

**Board-to-Board Spacing** — page 63

**Technical Documents** — page 64

**Product Specification** 108-1093

**Application Specification** 114-25035

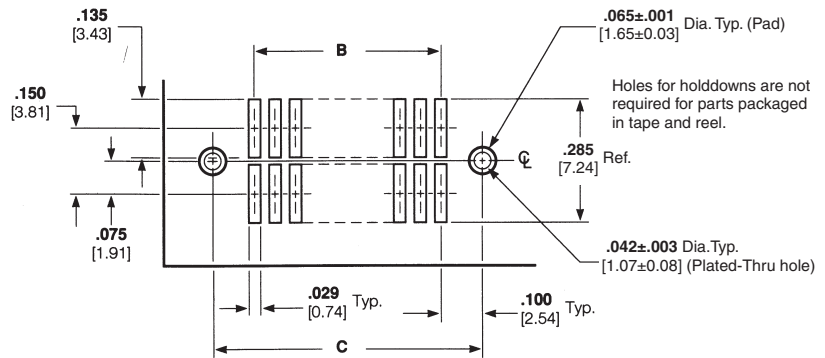

**Recommended PC Board Layout**

| No. of Pos. | Dimensions    |               |               | Part Numbers |                     |
|-------------|---------------|---------------|---------------|--------------|---------------------|
|             | A             | B             | C             | Pkg in Tube  | Pkg in Tape & Reel* |
| 10          | .294 [7.47]   | .200 [5.08]   | .400 [10.16]  | 5-104550-1   | 5-147378-1          |
| 20          | .544 [13.82]  | .450 [11.43]  | .650 [16.51]  | 5-104550-2   | 5-147378-2          |
| 24          | .644 [16.36]  | .550 [13.97]  | .750 [19.05]  | 5-104550-3   | 5-147378-9          |
| 30          | .794 [20.17]  | .700 [17.78]  | .900 [22.86]  | 5-104550-4   | 5-147378-3          |
| 40          | 1.044 [26.52] | .950 [24.13]  | 1.150 [29.21] | 5-104550-5   | 5-147378-4          |
| 50          | 1.294 [32.87] | 1.200 [30.48] | 1.400 [35.56] | 5-104550-6   | 5-147378-5          |
| 60          | 1.544 [39.22] | 1.450 [36.83] | 1.650 [41.91] | 5-104550-7   | 5-147378-6          |
| 80          | 2.044 [51.92] | 1.950 [49.53] | 2.150 [54.61] | 5-104550-8   | 5-147378-7          |
| 100         | 2.544 [64.62] | 2.450 [62.23] | 2.650 [67.31] | 5-104550-9   | 5-147378-8          |

\*Parts packaged in tape and reel are without hold downs and include a vacuum pick and place cover

**Note:** All part numbers are RoHS compliant.

## Cable-to-Board Connectors, .050 x .100 [1.27 x 2.54] Centerline FFC Cable

### Product Facts

- Signal application only, 1.5 amperes maximum single circuit
- Single or double row connectors
- Terminates flexible flat conductor cable and flexible etched circuitry
- Shielded cable provides for customizing
- Center latch housing providing positive latching

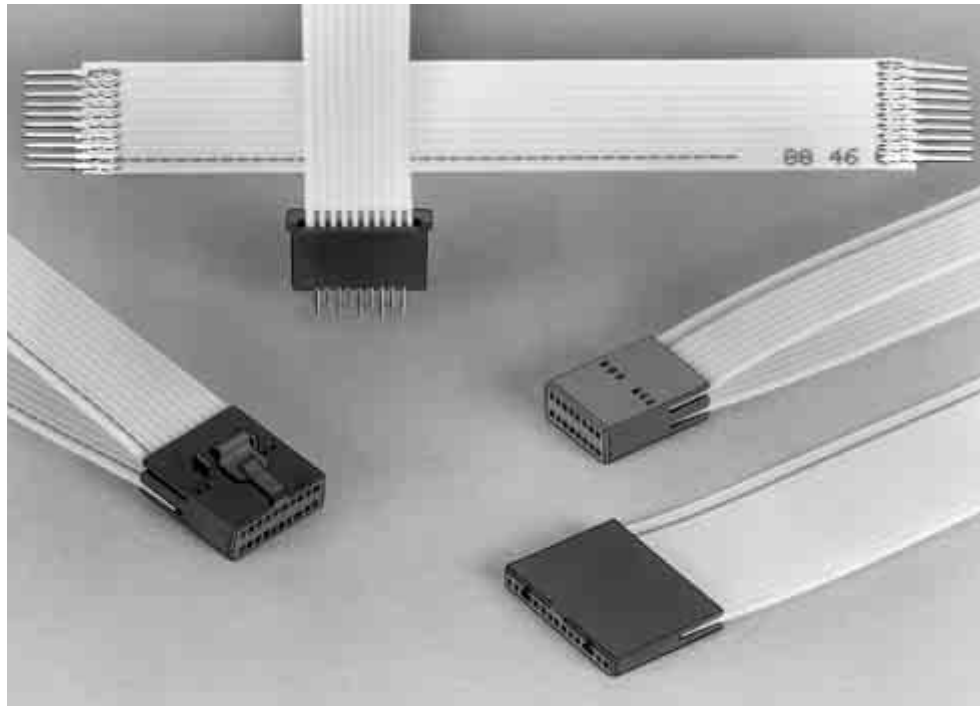

The cable-to-board .050 [1.27] center FFC receptacle connectors are part of the AMPMODU System 50 family for terminating flexible flat conductor cable and flexible etched circuitry.

The FFC receptacle uses a dual beam contact with 30 microinches of gold plating. The FFC receptacle connectors have an integral latch for positive locking to shrouded mating headers.

Flexible flat conductor cable is a planar parallel conductor cable. It can be used as a one-to-one connector or as a complex harness, allowing split-outs and special routing. The cable is comprised of .026 [0.66] wide x .003 [0.08] thick conductors made of copper per QQ-C-502 and insulated with a flame retardant polyester film.

The FFC contacts are available in receptacle and

solder tab. Receptacle contacts are made of phosphor bronze with a finish of plated gold duplex, while the solder tab contacts are finished in a bright tin-lead overall.

The complete product line provides solder tabs for board mounting at low cost and custom shielding of the cable.

**Cable-to-Board Connectors, .050 x .100 [1.27 x 2.54] Centerline FFC Cable] (Continued)**

**Custom Designed Cable Assemblies**

Tyco Electronics can supply customized flexible flat conductor cable assemblies using the components shown on pages 48 thru 54. Typical examples of these cable assemblies are shown to the right.

And, to meet the internal shielding requirements of today's complex electronic equipment, custom designed shielded FFC cable assemblies can be made to your specific specifications.

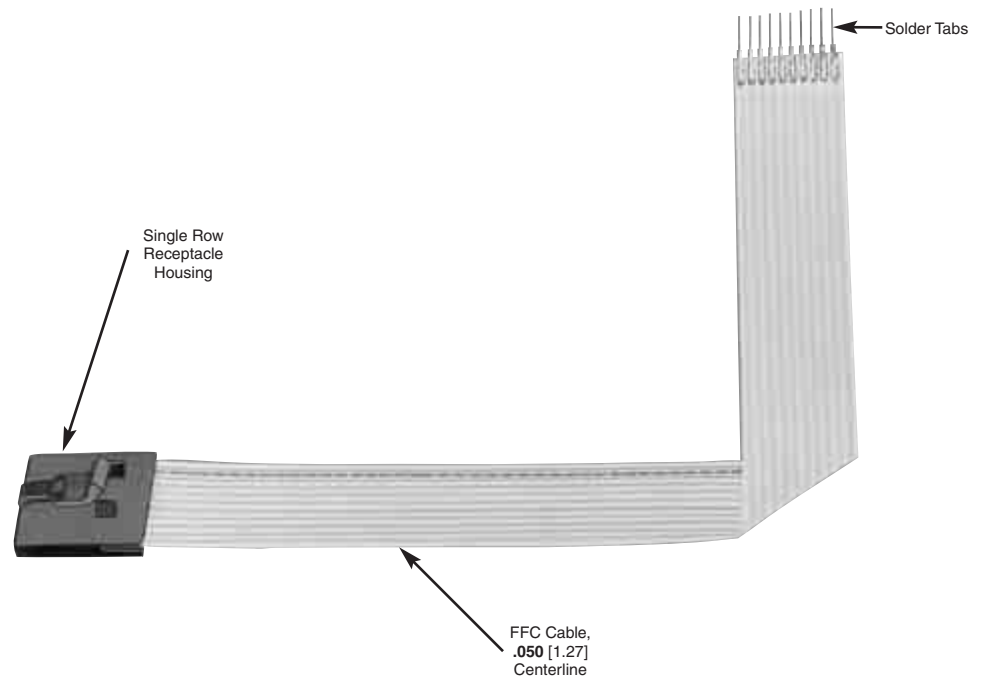
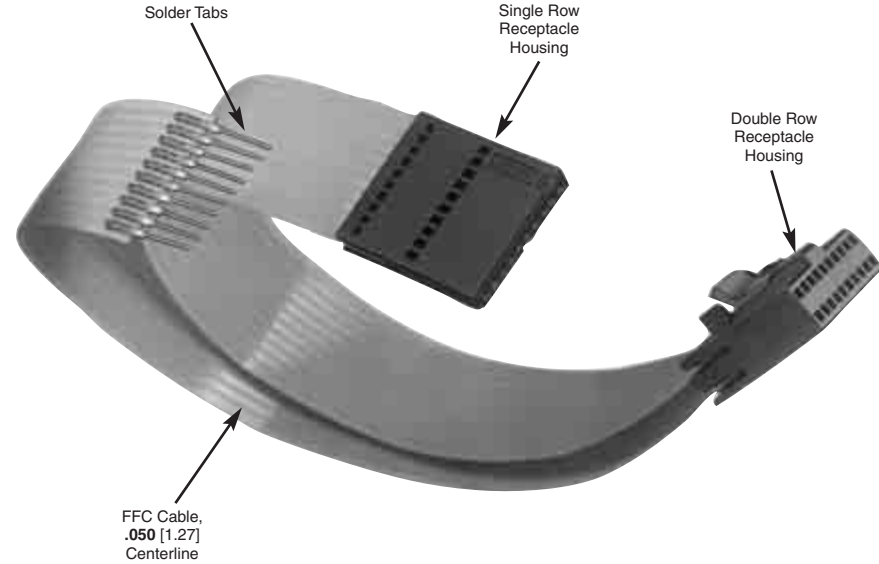

**FFC Contacts, .050 x .100 [1.27 x 2.54] Centerline**



Receptacle Strip



Solder Tab Strip

**Receptacle**

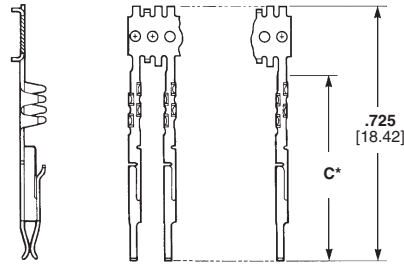

Accepts .015 [0.38] Sq. Post  
.125-.350 [3.18-8.89] Long

**Solder Tab**

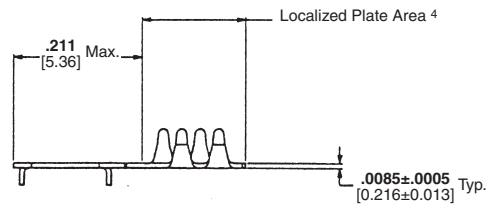
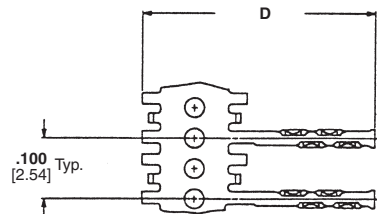
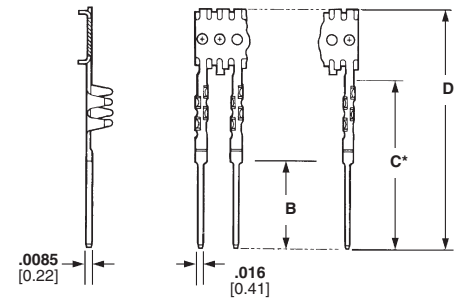

**Material and Finish**

Phosphor bronze; plated gold duplex or bright tin-lead overall (See chart.)

**Related Product Data**

**Performance Characteristics** — page 63

**Housings** — pages 49-52

**Application Tooling** — page 60-62

**Technical Documents** — page 64

**Product Specification** 108-16022

**Application Specification**  
114-16008

| Type           | Config. | Contacts<br>Part No./<br>Finish | Dimensions     |                 |                 | Application Tooling<br>Part Numbers |                            |
|----------------|---------|---------------------------------|----------------|-----------------|-----------------|-------------------------------------|----------------------------|
|                |         |                                 | B              | C*              | D               | Machine                             | Machine With<br>Programmer |
| Receptacle     | Strip   | 1-487547-1 <sup>1</sup>         | —              | .520<br>[13.21] | .725<br>[18.42] |                                     |                            |
|                | Strip   | 487923-4 <sup>2</sup>           | .245<br>[6.22] | .480<br>[12.19] | .685<br>[17.40] |                                     |                            |
| Solder Tab     | Strip   | 487923-5 <sup>3</sup>           | .245<br>[6.22] | .480<br>[12.19] | .685<br>[17.40] | 224910-4<br>(120 V)                 | 318619-4<br>(120 V)        |
|                | Strip   | 487940-4 <sup>2</sup>           | .110<br>[2.79] | .345<br>[8.76]  | .550<br>[13.97] | 224910-6<br>(240 V)                 | 318619-6<br>(240 V)        |
| Contact Splice | Strip   | 487941-4 <sup>4</sup>           | —              | —               | .385<br>[9.78]  |                                     |                            |
| Receptacle     | Strip   | 1-487547-2 <sup>5</sup>         | —              | .520<br>[13.21] | .725<br>[18.42] |                                     |                            |

<sup>1</sup>Duplex plated .000030 [0.00076] gold on mating area, .000100 [0.00254] min. bright tin in crimp area, with entire contact underplated .000050 [0.00127] min. nickel.

<sup>2</sup>Plated .000100 [0.00254] min. tin over .000050 [0.00127] min. nickel.

<sup>3</sup>Duplex plated .000015 [0.00038] gold on solder tab end, .000100 [0.00254] min. bright tin in crimp area, with entire contact underplated .000050 [0.00127] min. nickel.

<sup>4</sup>Plated .000150 [3.81µm] min. bright tin over .000050 [1.27µm] min. nickel.

<sup>5</sup>Duplex Plated .000150 [0.00038] gold on mating area, .000100 [0.00254] min bright tin in crimp area, with entire contact underplated .000050 [0.00127] min. nickel.

\*After cut-off from carrier strip.

**Note:** All part numbers are RoHS compliant.



**Single Row Receptacle Housings, .050 x .100 [1.27 x 2.54] Centerline, Cable-to-Board**



Plain Style Housings



Latch Style Housings

**Material and Finish**

**Housing** — Black thermoplastic, flame retardant, 94V-0 rated

**Related Product Data**

**Performance Characteristics** — page 63

**Receptacle Contacts** — page 48

**Mateable Headers** — pages 27, 28, 32 & 33

**Technical Documents** — page 64

**Product Specification** 108-16022

**Application Specification** 114-16008

**Plain Style Housings**

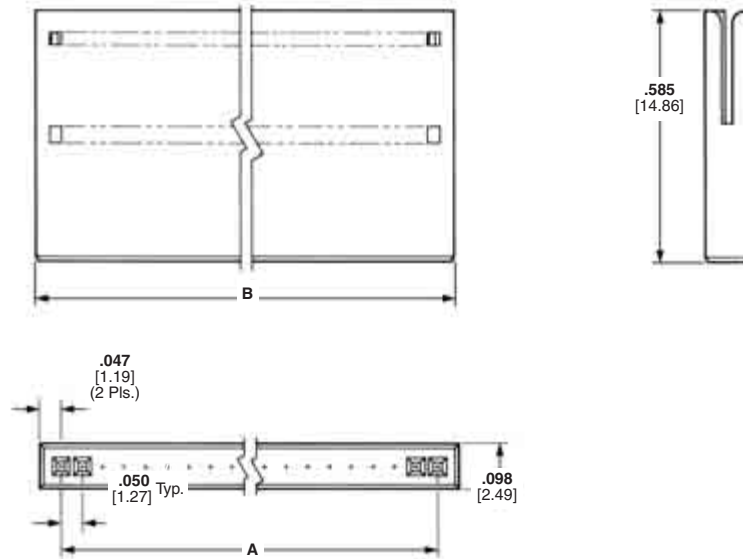

**Latch Style Housings**

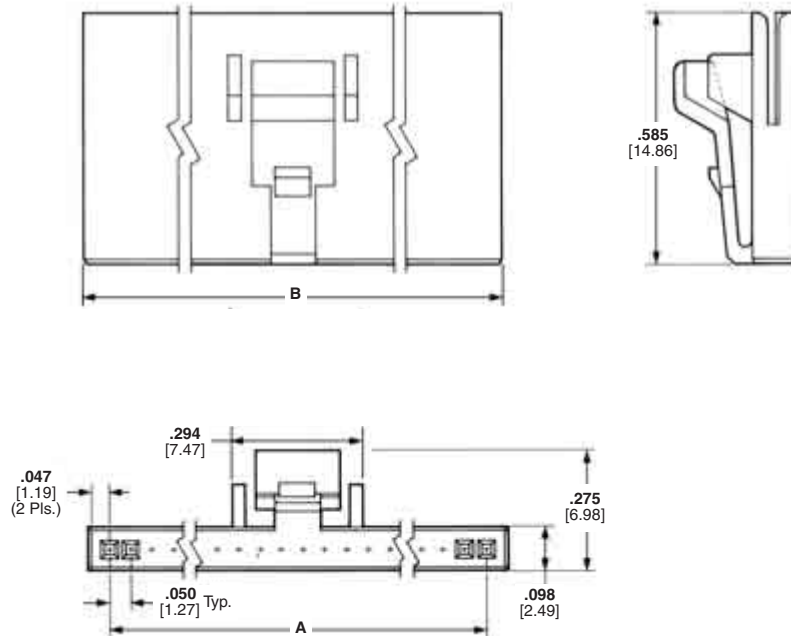

**Single Row Receptacle Housings, .050 x .100 [1.27 x 2.54] Centerline,**  
**Cable-to-Board (Continued)**

| No. of Pos. | Dimensions    |               | Part Numbers             |                                |
|-------------|---------------|---------------|--------------------------|--------------------------------|
|             | A             | B             | Plain Receptacle Housing | Latch Style Receptacle Housing |
| 4           | .150 [3.18]   | .244 [6.20]   | 487544-1                 | 487545-1                       |
| 5           | .200 [5.08]   | .294 [7.47]   | 487544-2                 | 487545-2                       |
| 6           | .250 [6.35]   | .344 [8.74]   | 487544-3                 | 487545-3                       |
| 7           | .300 [7.62]   | .394 [10.01]  | 487544-4                 | 487545-4                       |
| 8           | .350 [8.89]   | .444 [11.28]  | 487544-5                 | 487545-5                       |
| 10          | .450 [11.43]  | .544 [13.82]  | 487544-7                 | 487545-7                       |
| 12          | .550 [13.97]  | .644 [16.36]  | 487544-9                 | 487545-9                       |
| 13          | .600 [15.24]  | .694 [17.63]  | —                        | 1-487545-0                     |
| 15          | .700 [17.78]  | .794 [20.17]  | 1-487544-2               | 1-487545-2                     |
| 16          | .750 [19.05]  | .844 [21.44]  | 1-487544-3               | —                              |
| 17          | .800 [20.32]  | .894 [22.71]  | 1-487544-4               | 1-487545-4                     |
| 20          | .950 [24.13]  | 1.044 [26.52] | 1-487544-7               | 1-487545-7                     |
| 22          | 1.050 [26.67] | 1.144 [29.06] | 1-487544-9               | 1-487545-9                     |
| 25          | 1.200 [30.48] | 1.294 [32.87] | 2-487544-2               | 2-487545-2                     |
| 26          | 1.250 [31.75] | 1.343 [34.11] | —                        | 2-487545-3                     |
| 28          | 1.350 [34.29] | 1.443 [36.65] | —                        | 2-487545-5                     |
| 30          | 1.450 [36.83] | 1.544 [39.22] | —                        | 2-487545-7                     |
| 36          | 1.750 [44.45] | 1.844 [46.84] | 3-487544-3               | 3-487545-3                     |
| 40          | 1.950 [49.53] | 2.044 [51.92] | —                        | 3-487545-7                     |
| 45          | 2.200 [55.88] | 2.294 [58.27] | —                        | 4-487545-2                     |
| 50          | 2.450 [62.23] | 2.544 [64.62] | 4-487544-7               | 4-487545-7                     |

**Note:** Other sizes of receptacle housings (plain and latch style) can be made available, consult Tyco Electronics.

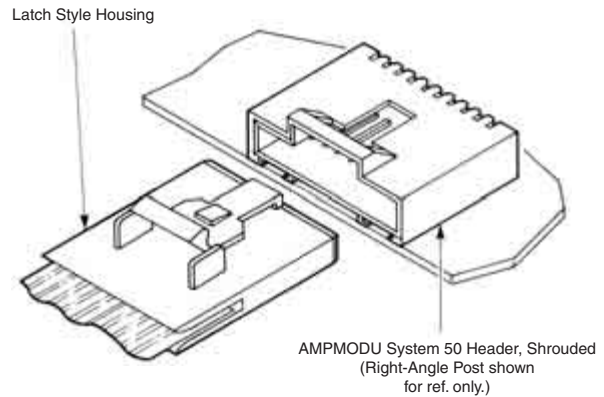
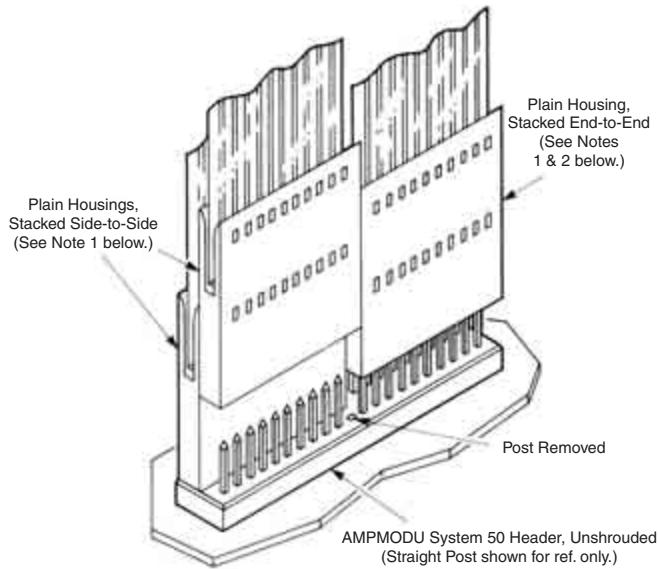

- Notes:** 1. Plain housings are side-to-side stackable on either straight or right-angle posted, unshrouded AMPMODU System 50 headers.  
2. For end-to-end stacking, the posts located between the adjoining housings must be removed to provide housing end clearance.

**Typical Cable-to-Board Application of Plain Receptacle Housing**

**Typical Cable-to-Board Application of Latch Style Receptacle Housing**

**Note:** All part numbers are RoHS compliant.

**Double Row Receptacle Housings, .050 x .100 [1.27 x 2.54] Centerline, Cable-to-Board**



Plain Style Housings



Latch Style Housings

**Plain Style Housings**

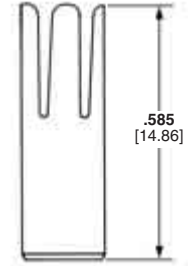
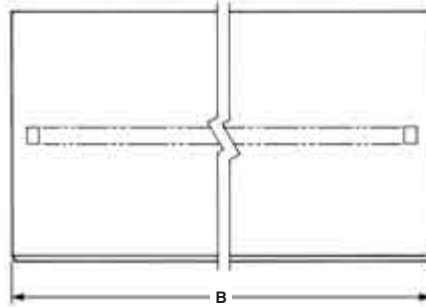

Plain

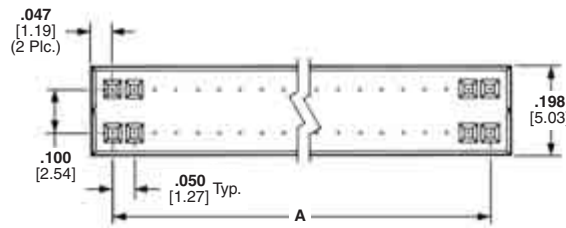

**Material**

Black thermoplastic, flame retardant, 94V-0 rated

**Related Product Data**

**Performance Characteristics** — page 63

**Receptacle Contacts** — page 48

**Mateable Headers** — pages 29, 30, 34, 35, & 44

**Latch Style Housings**

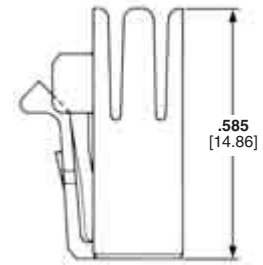
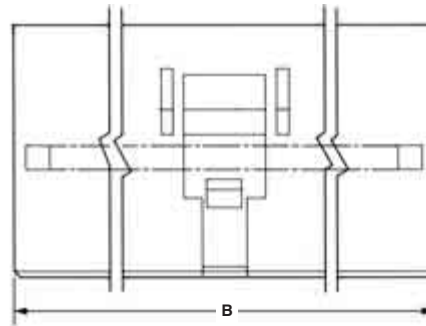

Latch

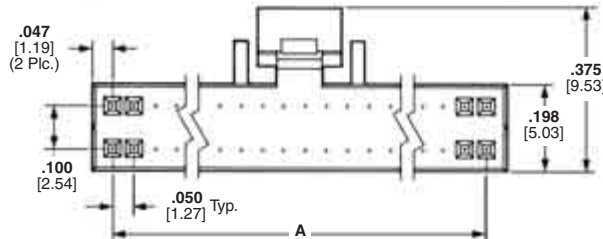

**Technical Documents** — page 64

**Product Specification** 108-16022

**Application Specification** 114-16008

**Double Row Receptacle Housings, .050 x .100 [1.27 x 2.54] Centerline, Cable-to-Board (Continued)**

| No. of Pos. | Dimensions    |               | Plain Housing Part Numbers | Latch Style Housing Part Numbers |
|-------------|---------------|---------------|----------------------------|----------------------------------|
|             | A             | B             |                            |                                  |
| 8           | .150 [3.81]   | .247 [6.27]   | 487938-8                   | 487937-8                         |
| 10          | .200 [5.08]   | .297 [7.54]   | 1-487938-0                 | 1-487937-0                       |
| 12          | .250 [6.35]   | .374 [8.81]   | 1-487938-2                 | 1-487937-2                       |
| 14          | .300 [7.62]   | .397 [10.08]  | 1-487938-4                 | 1-487937-4                       |
| 16          | .350 [8.89]   | .447 [11.35]  | 1-487938-6                 | 1-487937-6                       |
| 20          | .450 [11.43]  | .547 [13.89]  | 2-487938-0                 | 2-487937-0                       |
| 24          | .550 [13.97]  | .647 [16.43]  | 2-487938-4                 | 2-487937-4                       |
| 26          | .600 [15.24]  | .697 [17.7]   | 2-487938-6                 | 2-487937-6                       |
| 30          | .700 [17.78]  | .797 [20.24]  | 3-487938-0                 | 3-487937-0                       |
| 34          | .800 [20.32]  | .897 [22.78]  | 3-487938-4                 | 3-487937-4                       |
| 40          | .950 [24.13]  | 1.047 [26.59] | 4-487938-0                 | 4-487937-0                       |
| 44          | 1.050 [26.67] | 1.147 [29.13] | 4-487938-4                 | 4-487937-4                       |
| 50          | 1.200 [30.48] | 1.297 [39.94] | 5-487938-0                 | 5-487937-0                       |
| 60          | 1.450 [36.83] | 1.547 [39.29] | —                          | 6-487937-0                       |
| 72          | 1.750 [44.45] | 1.847 [46.91] | 7-487938-2                 | 7-487937-2                       |
| 80          | 1.950 [49.53] | 2.047 [51.99] | 8-487938-0                 | 8-487937-0                       |
| 100         | 2.450 [62.23] | 2.547 [64.69] | 487938-1                   | 487937-1                         |

**Note:** Other sizes of receptacle housings, up to 120 positions, can be made available, consult Tyco Electronics.

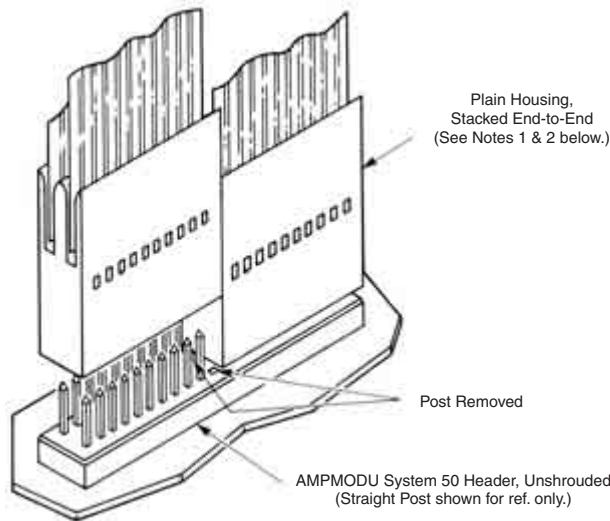

- Notes:**
1. Plain housings are end-to-end stackable on either straight or right-angle posted, unshrouded AMPMODU System 50 headers.
  2. For end-to-end stacking, the two posts located between the adjoining housings must be removed to provide housing end clearance.

**Typical Cable-to-Board Application of Plain Receptacle Housing**

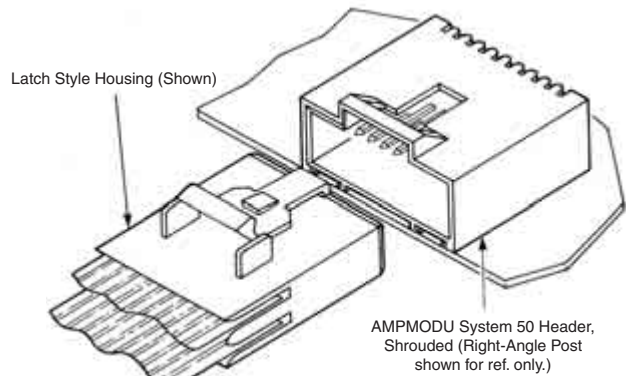

**Typical Cable-to-Board Application of Latch Style Receptacle Housing**

**Note:** All part numbers are RoHS compliant.

**ZIF-Line Connectors, .050 x .100 [1.27 x 2.54] Centerline, Cable-to-Board**

**Vertical Cable Entry**

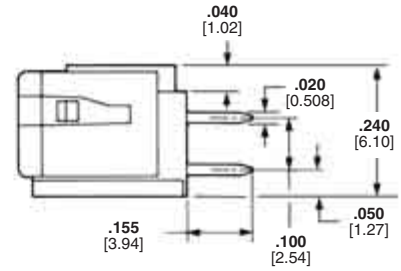
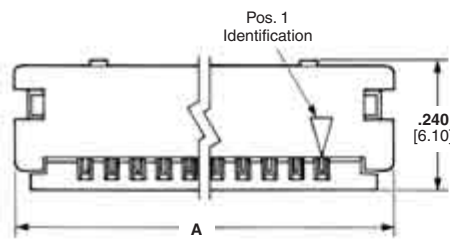

**Material and Finish**

**Housing and Cover** — Black thermoplastic, flame retardant, 94V-0 rated

**Contacts** — Phosphor bronze, plated .000150 [0.00381] min. bright tin over .000050 [0.00127] min. nickel on entire contact

**Performance Characteristic**

**Contact Current Rating** — 1 ampere†

†1 ampere rating is for single circuit. Multiple circuits, ambient temperature and conductor size affect current carrying capacity.

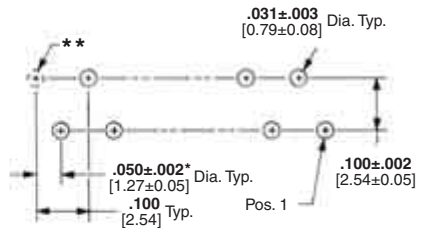
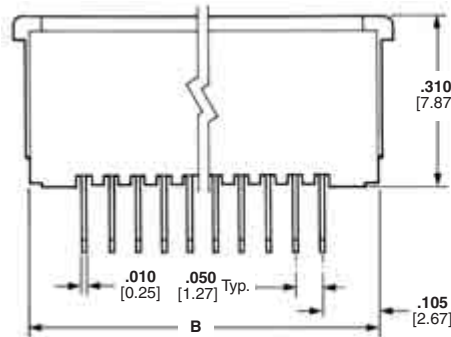

**Recommended Mounting Hole Pattern**

\*±.002 [±0.05] tolerance not to accumulate within one mounting hole pattern.

\*\*This mounting hole required for even-numbered connector sizes only.

**Note:** ZIF-Line connector illustrated above with cover in closed position.

**Related Product Data**

**FFC Cable (with Tin-Plated Prepared Ends)** — Consult Tyco Electronics.

**Technical Documents** — page 64

**Product Specification** 108-16025

**Application Specification** 114-16014

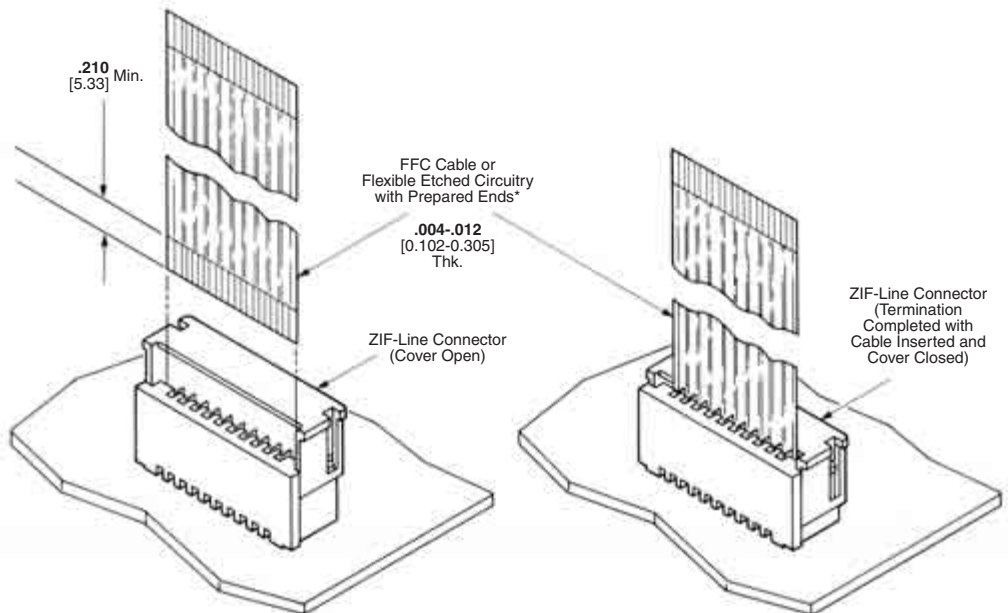

\*FFC cable with tin-plated prepared ends can be made available, consult Tyco Electronics.

**Note:** Special preparation of cable is required, refer to Tyco Electronics Application Specification No. 114-16014.

**Typical Flexible Flat Conductor Cable-to-Board Application**

**ZIF-Line Connectors, .050 x .100 [1.27 x 2.54] Centerline,  
Cable-to-Board (Continued)**

| No. of Pos. | Dimensions    |               | Connector Part Numbers |
|-------------|---------------|---------------|------------------------|
|             | A             | B             |                        |
| 5           | .470 [11.94]  | .410 [10.41]  | 5-487576-0             |
| 6           | .520 [13.21]  | .460 [11.68]  | 5-487576-1             |
| 7           | .570 [14.48]  | .510 [12.95]  | 4-487576-8             |
| 8           | .620 [15.75]  | .560 [14.22]  | 4-487576-9             |
| 9           | .670 [17.02]  | .610 [15.49]  | 487576-1               |
| 10          | .720 [18.29]  | .660 [16.76]  | 487576-2               |
| 11          | .770 [19.56]  | .710 [18.03]  | 487576-3               |
| 12          | .820 [20.83]  | .760 [19.30]  | 487576-4               |
| 13          | .870 [22.10]  | .810 [20.57]  | 487576-5               |
| 14          | .920 [23.37]  | .860 [21.84]  | 487576-6               |
| 15          | .970 [24.64]  | .910 [23.11]  | 487576-7               |
| 16          | 1.020 [25.91] | .960 [24.38]  | 487576-8               |
| 17          | 1.070 [27.18] | 1.010 [25.65] | 487576-9               |
| 18          | 1.120 [28.45] | 1.060 [26.92] | 1-487576-0             |
| 19          | 1.170 [29.72] | 1.110 [28.19] | 1-487576-1             |
| 20          | 1.220 [30.99] | 1.160 [29.46] | 1-487576-2             |
| 21          | 1.270 [32.26] | 1.210 [30.73] | 1-487576-3             |
| 22          | 1.320 [33.53] | 1.260 [32.00] | 1-487576-4             |
| 23          | 1.370 [34.80] | 1.310 [33.27] | 1-487576-5             |
| 24          | 1.420 [36.07] | 1.360 [34.54] | 1-487576-6             |
| 25          | 1.470 [37.34] | 1.410 [35.81] | 1-487576-7             |
| 26          | 1.520 [38.61] | 1.460 [37.08] | 1-487576-8             |
| 27          | 1.570 [39.88] | 1.510 [38.35] | 1-487576-9             |
| 28          | 1.620 [41.15] | 1.560 [39.62] | 2-487576-0             |
| 29          | 1.670 [42.42] | 1.610 [40.89] | 2-487576-1             |
| 30          | 1.720 [43.69] | 1.660 [42.16] | 2-487576-2             |

| No. of Pos. | Dimensions    |               | Connector Part Numbers |
|-------------|---------------|---------------|------------------------|
|             | A             | B             |                        |
| 31          | 1.770 [44.96] | 1.710 [43.43] | 2-487576-3             |
| 32          | 1.820 [46.23] | 1.760 [44.70] | 2-487576-4             |
| 33          | 1.870 [47.50] | 1.810 [45.97] | 2-487576-5             |
| 34          | 1.920 [48.77] | 1.860 [47.24] | 2-487576-6             |
| 35          | 1.970 [50.04] | 1.910 [48.51] | 2-487576-7             |
| 36          | 2.020 [51.31] | 1.960 [49.78] | 2-487576-8             |
| 37          | 2.070 [52.58] | 2.010 [51.05] | 2-487576-9             |
| 38          | 2.120 [53.85] | 2.060 [52.32] | 3-487576-0             |
| 39          | 2.170 [55.12] | 2.110 [53.59] | 3-487576-1             |
| 40          | 2.220 [56.39] | 2.160 [54.86] | 3-487576-2             |
| 41          | 2.270 [57.66] | 2.210 [56.13] | 3-487576-3             |
| 42          | 2.320 [58.93] | 2.260 [57.40] | 3-487576-4             |
| 43          | 2.370 [60.20] | 2.310 [58.67] | 3-487576-5             |
| 44          | 2.420 [61.47] | 2.360 [59.94] | 3-487576-6             |
| 45          | 2.470 [62.74] | 2.410 [61.21] | 3-487576-7             |
| 46          | 2.520 [64.01] | 2.460 [62.48] | 3-487576-8             |
| 47          | 2.570 [65.28] | 2.510 [63.75] | 3-487576-9             |
| 48          | 2.620 [66.55] | 2.560 [65.02] | 4-487576-0             |
| 49          | 2.670 [67.82] | 2.610 [66.29] | 4-487576-1             |
| 50          | 2.720 [69.09] | 2.660 [67.56] | 4-487576-2             |
| 51          | 2.770 [70.36] | 2.710 [68.83] | 4-487576-3             |
| 52          | 2.820 [71.63] | 2.760 [70.10] | 4-487576-4             |
| 53          | 2.870 [72.90] | 2.810 [71.37] | 4-487576-5             |
| 54          | 2.920 [74.17] | 2.860 [72.64] | 4-487576-6             |
| 55          | 2.970 [75.44] | 2.910 [73.91] | 4-487576-7             |

**Note:** All part numbers are RoHS compliant.

## Cable-to-Board Connectors, .050 x .100 [1.27 x 2.54] Centerline, Ribbon Cable, System 50

### Product Facts

- Preassembled housing and cover
- One step termination
- End and daisy chain termination
- Positive end latching of connector to shrouded headers
- Terminates 30 AWG [0.05 mm<sup>2</sup>] solid or stranded and 32 AWG [0.03 mm<sup>2</sup>]\* stranded .025 [0.64] centerline ribbon cable with PVC insulation
- 0.5 ampere current rating (limited by cable)

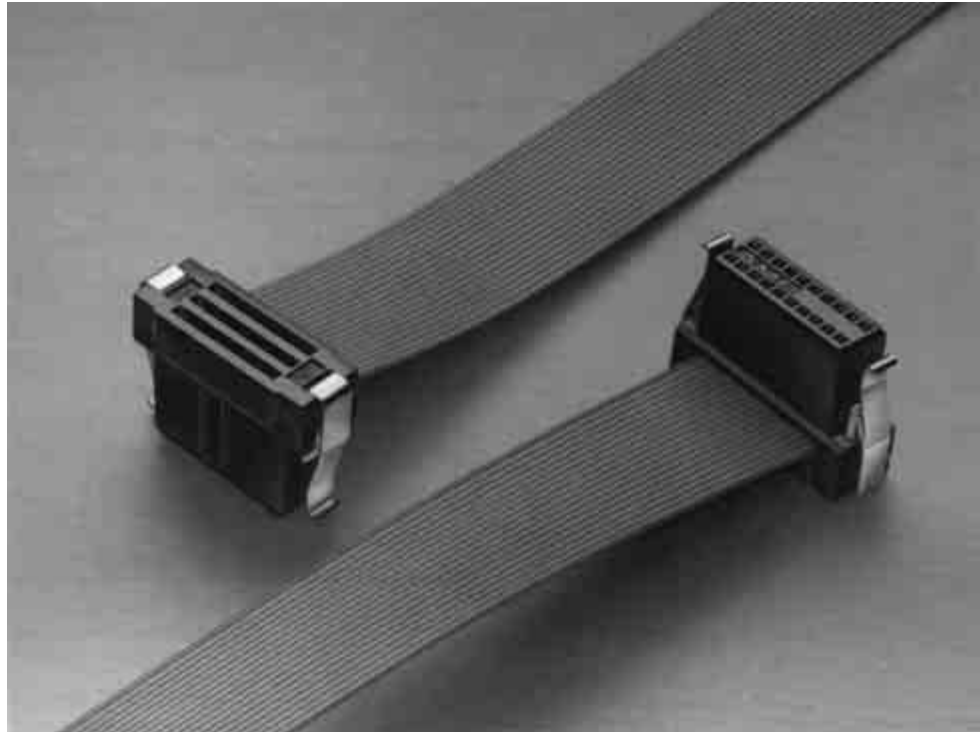

The AMP-LATCH System 50 Ribbon Cable connector is a receptacle connector that will terminate ribbon cable on .025 [0.64] centerlines. It is available in select sizes from 10 to 100 positions and will accommodate 30 AWG [0.05 mm<sup>2</sup>] solid or stranded and 32 AWG [0.03 mm<sup>2</sup>]

stranded conductors, with PVC cable insulation.

The housing and cover (black) have a 94V-0 rating. A copper alloy single mating beam contact provides the interconnect between the conductor and the .015 [0.38] square posts on the .050 x .100 [1.27 x 2.54] grid. The

contacts are plated with 30 gold duplex plating. The latching feature is located on the receptacle, not the header, and saves board space and eliminates future problems of "latch height compatibility."

**Double Row Receptacles, .050 x .100 [1.27 x 2.54] Centerline,  
Cable-to-Board, Ribbon Cable, System 50**

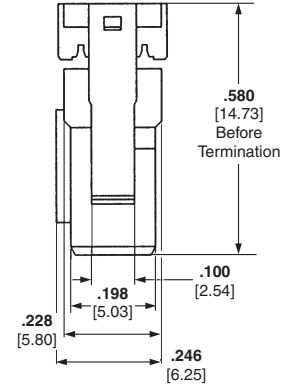
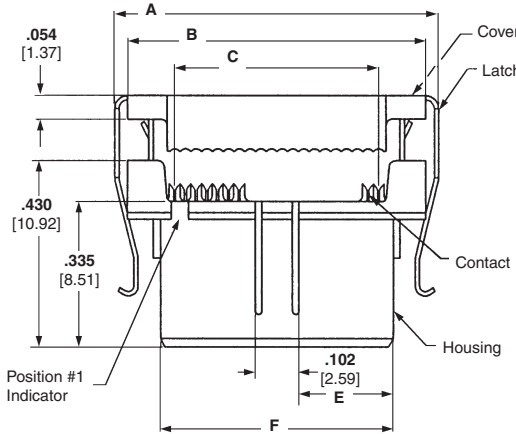
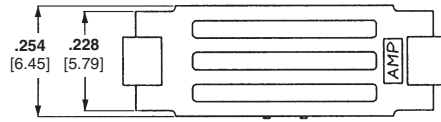

**Material and Finish**

- Housing** — Black thermoplastic, 94V-0 rated
- Latches** — Stainless steel
- Contacts** — Copper alloy, plated gold over nickel with tin in termination area

**Related Product Data**

- Performance Characteristics** — page 63
- Mateable Headers** — pages 29, 30, 34, 35 & 44
- Application Tooling** — page 60-62
- Mates with Posts** — .015 [0.38] square, .125 [3.18] long, on .050 x .100 [1.27 x 2.54] grid

- Technical Documents** — page 64
- Product Specification** 108-1109
- Application Specification** 114-25029

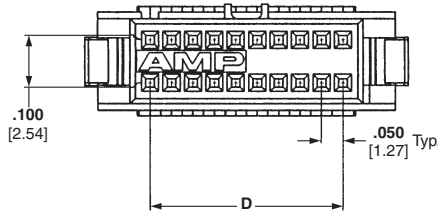

| No. of Pos. | Dimensions    |               |               |               |               |               | Part Numbers |
|-------------|---------------|---------------|---------------|---------------|---------------|---------------|--------------|
|             | A             | B             | C             | D             | E             | F             |              |
| 10          | .510 [12.95]  | .445 [11.30]  | .225 [5.72]   | .200 [5.08]   | .096 [2.44]   | .294 [7.47]   | 2-111196-5   |
| 14          | .610 [15.49]  | .545 [13.84]  | .325 [8.26]   | .300 [7.62]   | .146 [3.71]   | .394 [10.01]  | 2-111196-6   |
| 16          | .660 [16.76]  | .595 [15.11]  | .375 [9.52]   | .350 [8.89]   | .171 [4.34]   | .444 [11.28]  | 2-111196-7   |
| 20          | .760 [19.30]  | .695 [17.65]  | .475 [12.07]  | .450 [11.43]  | .221 [5.61]   | .544 [13.82]  | 1-111196-8   |
| 24          | .860 [20.32]  | .795 [20.19]  | .575 [14.61]  | .550 [13.97]  | .271 [6.88]   | .644 [16.36]  | 2-111196-8   |
| 26          | .910 [23.11]  | .845 [21.46]  | .625 [15.88]  | .600 [15.24]  | .296 [7.52]   | .694 [17.63]  | 2-111196-9   |
| 30          | 1.010 [25.65] | .945 [24.00]  | .725 [18.42]  | .700 [17.78]  | .346 [8.79]   | .794 [20.17]  | 1-111196-9   |
| 34          | 1.110 [28.19] | 1.045 [26.54] | .825 [20.96]  | .800 [20.32]  | .396 [10.06]  | .894 [22.71]  | 3-111196-0   |
| 40          | 1.260 [32.00] | 1.195 [30.35] | .975 [34.54]  | .950 [24.13]  | .471 [11.96]  | 1.044 [26.52] | 2-111196-0   |
| 44          | 1.360 [34.54] | 1.295 [32.89] | 1.075 [27.31] | 1.050 [26.67] | .521 [13.23]  | 1.144 [29.06] | 3-111196-1   |
| 50          | 1.510 [38.35] | 1.445 [36.70] | 1.225 [31.12] | 1.200 [30.48] | .596 [15.14]  | 1.294 [32.87] | 2-111196-1   |
| 60          | 1.760 [44.70] | 1.695 [43.05] | 1.475 [37.47] | 1.450 [36.83] | .721 [18.31]  | 1.544 [39.22] | 2-111196-2   |
| 64          | 1.860 [47.24] | 1.795 [45.59] | 1.575 [40.00] | 1.550 [39.37] | .771 [19.58]  | 1.644 [41.76] | 3-111196-2   |
| 68          | 1.960 [49.78] | 1.895 [48.13] | 1.675 [42.55] | 1.650 [41.91] | .821 [20.85]  | 1.744 [44.30] | 3-111196-4   |
| 72          | 2.060 [52.32] | 1.995 [50.67] | 1.775 [45.08] | 1.750 [44.45] | .871 [22.12]  | 1.844 [46.84] | 2-111196-3   |
| 80          | 2.260 [57.40] | 2.195 [55.75] | 1.975 [50.17] | 1.950 [49.53] | .971 [24.66]  | 2.044 [51.92] | 3-111196-3   |
| 100         | 2.760 [70.10] | 2.695 [68.45] | 2.475 [62.87] | 2.450 [62.23] | 1.221 [31.01] | 2.544 [64.62] | 2-111196-4   |

**Note:** All part numbers are RoHS compliant.



**Paddleboard Receptacles, .050 x .100 [1.27 x 2.54] Centerline, Cable-to-Board, Ribbon Cable, System 50**

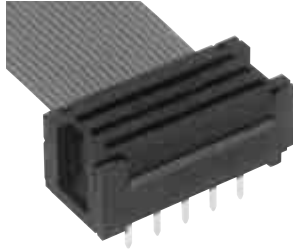

**Material and Finish**

**Housing** — Black LCP thermoplastic, 94V-0 rated

**Cover** — Black polyester, 94V-0 rated

**Contacts** — Copper alloy, plated .000100-.000200 [0.00245-0.00508] bright tin over .000050-.000100 [0.00127-0.00254] nickel

**Related Product Data**

**Performance Characteristics** — page 63

**Application Tooling** — pages 60-62

**Technical Documents** — page 64

**Product Specification** 108-1109

**Application Specification** 114-25040

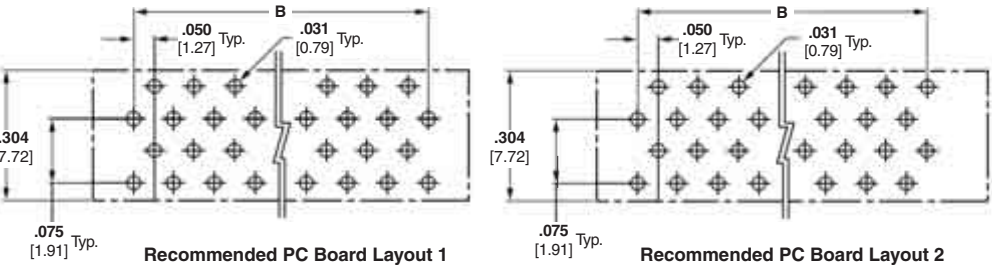
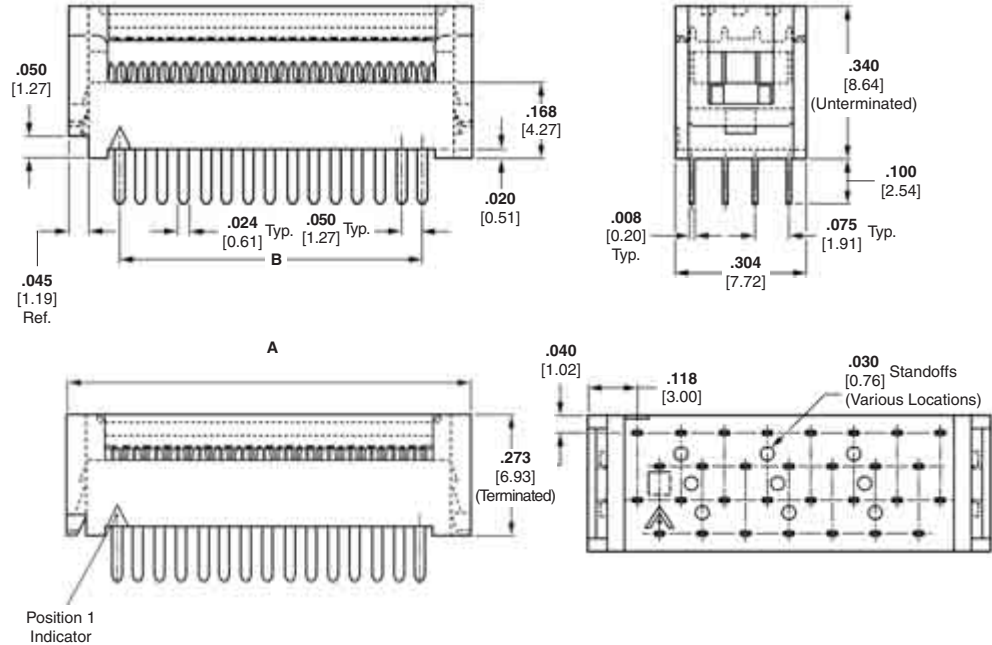

| No. of Pos. | PCB Hole Layout | Dimensions    |              | Part Numbers |
|-------------|-----------------|---------------|--------------|--------------|
|             |                 | A             | B            |              |
| 10          | 1               | .436 [11.07]  | .200 [5.08]  | 5111595-1    |
| 14          | 1               | .536 [13.61]  | .300 [7.62]  | 5111595-2    |
| 16          | 2               | .586 [14.88]  | .350 [8.89]  | 5111595-3    |
| 20          | 2               | .686 [17.42]  | .450 [11.43] | 5111595-4    |
| 24          | 2               | .786 [19.96]  | .550 [13.97] | 5111595-5    |
| 26          | 1               | .836 [21.23]  | .600 [15.24] | 5111595-6    |
| 28          | 2               | .886 [22.50]  | .650 [16.51] | 2-5111595-0  |
| 30          | 1               | .936 [23.77]  | .700 [17.78] | 5111595-7    |
| 34          | 1               | 1.036 [26.31] | .800 [20.32] | 5111595-8    |
| 40          | 2               | 1.186 [30.12] | .950 [24.13] | 5111595-9    |

| No. of Pos. | PCB Hole Layout | Dimensions    |               | Part Numbers |
|-------------|-----------------|---------------|---------------|--------------|
|             |                 | A             | B             |              |
| 44          | 2               | 1.286 [32.66] | 1.050 [26.67] | 1-5111595-0  |
| 46          | 1               | 1.336 [33.93] | 1.100 [27.94] | 1-5111595-7  |
| 50          | 1               | 1.436 [36.47] | 1.200 [30.48] | 1-5111595-1  |
| 60          | 2               | 1.686 [42.82] | 1.450 [36.83] | 1-5111595-2  |
| 64          | 2               | 1.786 [45.36] | 1.550 [39.37] | 1-5111595-3  |
| 68          | 2               | 1.886 [47.90] | 1.650 [41.91] | 1-5111595-9  |
| 72          | 2               | 1.986 [50.44] | 1.750 [44.45] | 1-5111595-4  |
| 80          | 2               | 2.186 [55.52] | 1.950 [49.53] | 1-5111595-5  |
| 100         | 2               | 2.686 [68.22] | 2.450 [62.23] | 1-5111595-6  |

**Note:** All part numbers are RoHS compliant.

**Flat Ribbon Cable, PVC Insulation**

**30 AWG [0.05 mm<sup>2</sup>],  
Solid Bare Copper**

**Product Specifications**

**Voltage** — 150 Volts  
**Impedance** — 80 Ohms Nominal (GND, SIG, GND, applies to 30AWG Solid Bare Copper)  
**Capacitance** — 19.2 pf/ft at 1 MHz nom.  
**Propagation Delay** — 1.51 ns/ft nom.  
**Crosstalk** —  
 10 ft sample 5 ns rise time:  
 Near End — 4.0% max.  
 Far End — 6.0% max.  
**UL Listing** — STYLE 2678

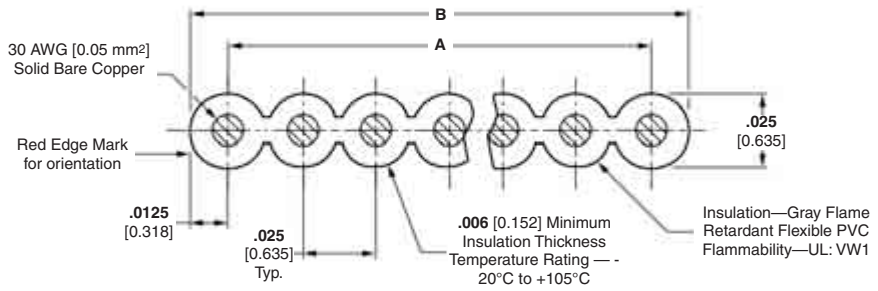

| No. of Conductors | Dimensions    |               | Part Numbers      |                   |
|-------------------|---------------|---------------|-------------------|-------------------|
|                   | A             | B             | Length Per Reel*  |                   |
|                   |               |               | 100 ft. [30.48 m] | 500 ft. [152.4 m] |
| 16                | .375 [9.52]   | .400 [10.16]  | 5-57013-1         | 5-57013-2         |
| 20                | .475 [12.07]  | .500 [12.70]  | 1-57013-3         | 57013-1           |
| 24                | .575 [14.61]  | .600 [15.24]  | 1-57013-4         | 57013-8           |
| 26                | .625 [15.88]  | .650 [16.51]  | 2-57013-5         | 2-57013-6         |
| 28                | .675 [17.14]  | .700 [17.78]  | 4-57013-6         | 4-57013-7         |
| 30                | .725 [18.42]  | .750 [19.05]  | 1-57013-5         | 57013-6           |
| 34                | .825 [20.95]  | .850 [21.59]  | 4-57013-9         | 5-57013-0         |
| 36                | .875 [22.23]  | .900 [22.86]  | 1-57013-6         | 57013-7           |
| 40                | .975 [24.77]  | 1.000 [25.40] | 1-57013-7         | 57013-2           |
| 44                | 1.075 [27.31] | 1.100 [27.94] | 1-57013-8         | 57013-9           |
| 50                | 1.225 [27.94] | 1.250 [31.75] | 1-57013-9         | 1-57013-0         |
| 60                | 1.475 [37.47] | 1.500 [38.10] | 2-57013-0         | 57013-3           |
| 68                | 1.675 [42.55] | 1.700 [43.18] | 2-57013-1         | 1-57013-1         |
| 72                | 1.775 [45.09] | 1.800 [45.72] | 2-57013-2         | 1-57013-2         |
| 80                | 1.975 [50.17] | 2.000 [50.80] | 2-57013-3         | 57013-4           |
| 100               | 2.475 [62.87] | 2.500 [63.50] | 2-57013-4         | 57013-5           |

\*Reel may contain separate lengths, 20 ft. [6.1 m] min. per length.

Recognized under the Component Program of Underwriters Laboratories Inc., File No. E53793



Certified by Canadian Standards Association, (CSA File No. LL83498)



**Electrical Characteristics of .025 [0.64] Centerline IDC Ribbon Cable**

| Base Part No.       | Insulation | AWG         | Voltage | Impedance Single Ended G-S-G | Capacitance Nominal G-S-G | Inductance Nominal | Nominal Prop. Delay | NEXT 10 Ft 5ns Rise Time | FEXT 10 Ft 5ns Rise Time |
|---------------------|------------|-------------|---------|------------------------------|---------------------------|--------------------|---------------------|--------------------------|--------------------------|
| 57013               | PVC        | 30 Solid    | 150 Vac | 80 Ohms Nom                  | 19.2 pf/ft                | .160 mh/ft         | 1.51 ns/ft          | 4.0% Max                 | 6.0% Max                 |
| 219054, 219137      | TPE        | 30 Solid    | 150 Vac | 90+/- 6 Ohms                 | 15.3 pf/ft                | .124 mh/ft         | 1.382 ns/ft         | 2.39% Nom                | 2.99% Nom                |
| 57119, 57139, 57145 | FEP        | 30 Solid    | 300 Vac | 93 Ohms Nom                  | 13.6 pf/ft                | .120 mn/ft         | 1.34 ns/ft          | 2.6% Nom                 | 2.8% Nom                 |
| 57131               | PVC        | 30 Stranded | 150 VAC | 66 Ohms Nom                  | 23.0 pf/ft                | .100 mh/ft         | 1.55 ns/ft          | 2.8% Max                 | 4.5% Max                 |
| 219055              | TPE        | 30 Stranded | 150 VAC | 78 Ohms Nom                  | 19.4 pf/ft                | .118 mh/ft         | 1.510 ns/fr         | 1.37% Nom                | 2.37% Nom                |
| 57288, 57289, 57290 | FEP        | 30 Stranded | 300 Vac | 85 Ohms Nom                  | 15.4 pf/ft                | .110 mh/ft         | 1.36 ns/ft          | 2.5% Nom                 | 2.8% Nom                 |
| 219253              | TPE        | 31 Stranded | 150 Vac | 90+/- 6 Ohms                 | 15.4 pf/ft                | .125 mh/ft         | 1.527 ns/ft         | 1.97% Nom                | 2.51% Nom                |
| 57038               | PVC        | 32 Stranded | 150 Vac | 80 Ohms Nom                  | 19.2 pf/ft                | .147 mh/ft         | 1.51 ns/ft          | 4.0% Max                 | 6.0% Max                 |
| 219138              | TPE        | 32 Stranded | 150 Vac | 104 Ohms Nom                 | 12.8 pf/ft                | .138 mh/ft         | 1.664 ns/ft         | 2.10% Nom                | 2.57% Nom                |
| 57118, 57138, 57144 | FEP        | 32 Stranded | 300 Vac | 105 Ohms Nom                 | 13.0 pf/ft                | .120 mh/ft         | 1.36 ns/ft          | 2.6% Nom                 | 2.8% Nom                 |

**Note:** All part numbers are RoHS compliant.

**Centerline IDC Ribbon Cable, PVC Insulation**

**30 AWG 7/38 Stranded Tinned Copper**

**For use with:**  
AMP-LATCH System 50, AMPLIMITE .050 Series and AMPMODU System 50 Connectors

**Compatible with:**  
AMP R-CAM Ribbon Cable Assembly Machine

**Product Specifications**

**Voltage Rating** — 150 Volts

**Impedance** — 66 ohms (GND, SIG, GND)

**Capacitance** — 23 pf/ft. at 1 KHz

**Propagation Delay** — 1.55 ns/ft. [5.6 ns/m]

**Crosstalk** —  
10 Ft. sample 5 ns rise time  
Near End — 2.8% max  
Near End — 4.5% max

**UL AWM** Style 2678

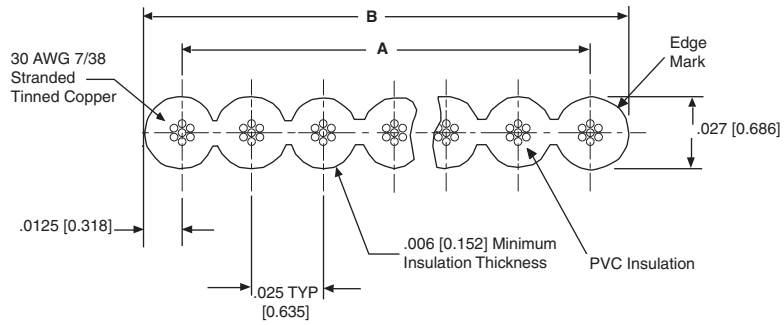

| No. of Conductors | Dimensions    |               | Part Numbers     |                   |
|-------------------|---------------|---------------|------------------|-------------------|
|                   | A             | B             | Length Per Reel  |                   |
|                   |               |               | 100 ft. [30.5 m] | 500 ft. [152.4 m] |
| 20                | .475 [12.07]  | .500 [12.70]  | 1-57131-3        | 57131-1           |
| 40                | .975 [24.77]  | 1.000 [25.40] | 1-57131-7        | 57131-2           |
| 50                | 1.225 [31.12] | 1.250 [31.75] | 1-57131-9        | 1-57131-0         |
| 68                | 1.675 [42.55] | 1.700 [43.18] | 2-57131-1        | 1-57131-1         |
| 80                | 1.975 [50.17] | 2.000 [50.80] | 2-57131-3        | 57131-4           |
| 100               | 2.475 [62.87] | 2.500 [63.50] | 2-57131-4        | 57131-5           |

Flat Ribbon Cable

**3**

**Note:** All part numbers are RoHS compliant.

## Application Tooling for Flexible Film Contacts

### Hand Crimping Tool Assemblies (for repair purposes)



**Part No. 90273-5**—for .100  $\text{C}$   
Multi-Crimp Contacts (408-9564)

### Extraction Tools for .100 $\text{C}$ Contacts

**Tool No. 91200-□\***— for Receptacle  
Housings with **Side Locking Lance  
Slot** (408-7916)

**Tool No. 91047-□\***— for Receptacle  
and Pin Housings with **End Locking  
Lance Slot** (408-7384)

\*Consult Tyco Electronics for  
specific dash nos.

For tooling information, contact the  
Technical Support Center:  
**1-800-522-6752.**

### Flexible Film Termination Machine (Terminates Continuous Strip Contacts Sequentially)



The flexible film semiautomatic bench machine for terminating .050 [1.27] and .100 [2.54] centerline flexible flat conductor cable (FFC), flexible etched circuitry (FEC), and flexible printed wiring (FPW) with AMP FFC reel-mounted contacts. For each cable or circuitry, the contacts are automatically applied one-at-a-time in a straight sequence. To skip positions, an optional programmer control box is available. Crimp height is easily adjustable in .0002 [.0051] increments. Termination rates up to 200 contacts per minute.

| Description                                 | Machine Part Numbers |                          |
|---|----------------------|--------------------------|
|   | Machine              | Machine With Programmer* |
| .100 [2.54] $\text{C}$ , Multi-Crimp, 120 V | 224910-1             | 318619-1                 |
| .100 [2.54] $\text{C}$ , Multi-Crimp, 240 V | 224910-2             | 318619-2                 |
| .100 [2.54] $\text{C}$ , ARINC, 120 V       | 224910-3             | 318619-3                 |
| .050 [1.27] $\text{C}$ , Multi-Crimp, 120 V | 224910-4             | 318619-4                 |
| .050 [1.27] $\text{C}$ , Multi-Crimp, 240 V | 224910-6             | 318619-6                 |

\*The Programmer Kit (**Part No. 356484-1**) may be purchased with a new machine, or separately for adding onto an existing machine.

### Technical Documents

**Customer Manuals**  
409-5835 (Part Numbers 224910 and 318619)  
409-5880 Programmer Kit (Part Number 356484-1)

### Specifications

**Width** — 20.5 [520]  
**Depth** — 27.5 [700]  
**Height** — 18 [460] (with reel support)  
**Reel Size** — 24 [610] (max.)  
**Weight** — 100 lb. [45.4 kg]  
**Electrical Source** —  
120 VAC, 50/60 Hz, 7.0 A;  
240 VAC, 50/60 Hz, 3.5 A

**Note:** All part numbers are RoHS compliant.

**Application Tooling for Compliant Pin Connectors**

**ASG Servo Electric Presses for Compliant Pin Connectors**

Tyco Electronics offers the ASG line of servo electric presses for the application of compliant pin products. Systems are available in a wide range of pressing forces, board size capabilities and automation levels to meet almost any applications requirements. Each system utilizes a servo electric motor with PC control. Coupled with force and distance monitoring and control, the entire line provides 100% quality assurance in real-time with SPC data collection capabilities. Automatic set up and a graphical operator interface help provide intuitive operation to help reduce common and costly operator errors.

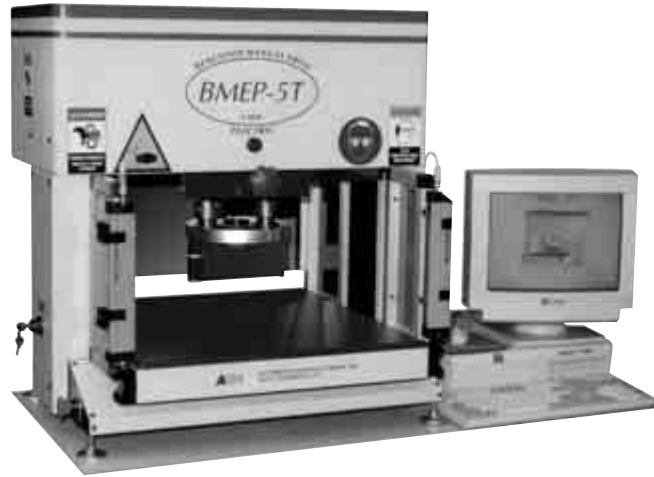

**Press Force Monitoring for Scrap Avoidance**

Every Tyco Electronics ASG servo press utilizes real-time force and distance monitoring and control. This allows the press to identify an error and react throughout the press stroke. Common problems such as PCB holes above/below specification and sometimes bent pins can be detected by monitoring both

minimum and maximum force parameters. Common operator error such as improperly placed connectors, missing\incorrect connector or tooling can also be found by monitoring premature or missing force parameters. In each case, the system can stop during the press cycle to avoid costly scrap and rework.

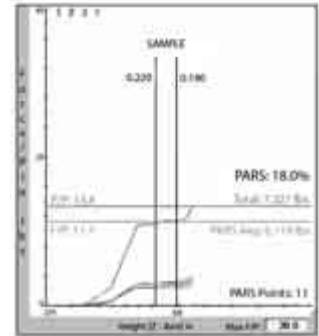

**Product Line Overview**



|                       | <b>BMEP</b>                   | <b>MEP</b>                       | <b>AEP 6T</b>                | <b>AEP 12T</b>                        |
|-----------------------|-------------------------------|----------------------------------|------------------------------|---------------------------------------|
| System Type           | Benchtop Semi-Automatic Press | Stand-Alone Semi-Automatic Press | Stand-Alone Automatic Press  | Stand-Alone or Inline Automatic Press |
| Force Capability      | Up to 5 Tons [44 kN]          | Up to 12 Tons [107 kN]           | Up to 6 Tons [53 kN]         | Up to 12 Tons [107 kN]                |
| Board Size Capability | Up to 18" x 24" [460x610 mm]  | Up to 30" x 36" [760x915 mm]     | Up to 30" x 36" [760x915 mm] | Up to 36" x 48" [915x1220 mm]         |

Please contact the Tyco Tooling Assistance Center at 1-800-722-1111 for help with choosing the correct press and tooling to meet your application needs. See Catalog 1309329 for more information on this equipment.

**Note:** All part numbers are RoHS compliant.

## Application Tooling for Ribbon Cable Connectors

These application tools are designed for one-step termination of ribbon cable connectors to planar, ground plane and shielded/jacketed ribbon cable on .025 [0.64] centers. A complete set of tooling consists of an Arbor Tool (manual, Part No. 91085-2 or pneumatic, Part No. 91112-3), a Base Assembly, Part No. 768338-4 and a Connector Specific Kit, Part No. 679167-1 (receptacle).



**Pneumatic Auto-Cycle Tool Part No. 91112-3**



**Manual Arbor Tool Part No. 91085-2**

### Technical Documents

#### Instruction Sheets

408-7777 — Manual Arbor Frame Assembly

408-6732 — Pneumatic Auto-Cycle Assembly

408-9827 — Universal Base Assembly, Arbor Tool

408-9872 — Connector Specific Kit for Receptacle Connectors (.025 [0.64] Centerline Cable)

408-9928 — Connector Specific Kit for Paddleboard Connectors (.025 [0.64] Centerline Cable)

**Note:** Tooling is available for other manufacturers' manual arbor tools. For information contact the Tyco Electronics Technical Support Center: 1-800-522-6752

**Note:** All part numbers are RoHS compliant.

**Performance Specifications**

**Board-to-Board Spacing for Thru-Hole and Surface-Mount Connector Combinations**

**Thru-Hole Receptacle-Thru-Hole Header**

(Single and Double Row, Shrouded and Unshrouded)

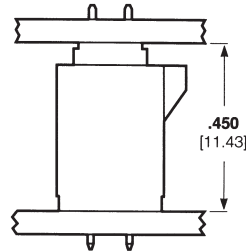

**Thru-Hole Receptacle-Surface-Mount Header**

(Double Row, Shrouded)

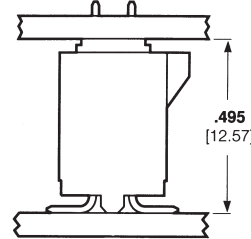

**Surface-Mount Receptacle-Thru-Hole Header**

(Double Row, Shrouded and Unshrouded)

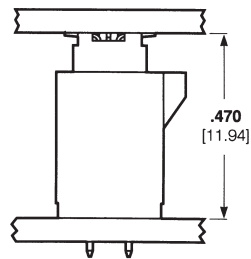

**Surface-Mount Receptacle-Surface-Mount Header**

(Double Row, Shrouded)

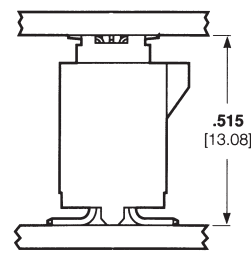

**Need more information?**

Call the Technical Support Center: **1-800-522-6752**.

The Technical Support Center is staffed with specialists well versed in all Tyco Electronics products. The Center can provide you with:

- Technical Support
- Catalogs
- Technical Documents
- Product Samples
- Tyco Electronics Authorized Distributor Locations

**Performance Specifications**

| Description                         | Board-to-Board, Thru-Hole Headers and Receptacles | Board-to-Board, Surface-Mount, Headers and Receptacles | Cable-to-Board, .050 [1.27] Centerline FFC Cable Receptacles | Cable-to-Board, .025 [0.64] Centerline Ribbon Cable Receptacles |
|-------------------------------------|---|--|--|---|
| Size Range-Single Row<br>Double Row | 4 thru 50<br>10 thru 100                          | —<br>10 thru 100                                       | 4 thru 50<br>8 thru 100                                      | —<br>10 thru 100  |
| Current Rating (per contact)        | 1.0 amperes                                       | 1.0 amperes  | 1.5 amperes  | 0.5 amperes   |
| Dielectric Withstanding Voltage     | 500 VAC   | 500 VAC  | 300 VAC  | 200 VAC   |
| Insulation Resistance               | 5,000 Megohms                                     | 5,000 Megohms  | 5,000 Megohms  | 5,000 Megohms   |
| Durability (tested to)              | 200 Cycles  | 200 Cycles   | 200 Cycles   | 150 Cycles  |
| Mating Force (per contact)          | 5 oz. [1.38 N] Max.                               | 5 oz. [1.38 N] Max.                                    | 8 oz. [2.22 N] Max.  | 4 oz. [1.11 N] Max.   |
| Unmating Force (per contact)        | 0.8 oz. [0.22 N] Min.                             | 0.8 oz. [0.22 N] Min.                                  | 1.0 oz. [0.27 N] Min.  | *0.5 oz. [0.13 N] Min.  |
| Operating Temperature               | -65°C to +105°C                                   | -65°C to +105°C  | -55°C to +105°C  | -65°C to +105°C   |

\*With latches depressed.

## Technical Documents

The following is a list of technical documents covering the application, performance and maintenance of AMPMODU System 50 connectors.

**Product Specifications** describe technical performance characteristics and verification tests. They are intended for the Design, Component and Quality Engineer.

- 108-1093—AMPMODU System 50 Interconnection System, Board-to-Board
- 108-1109—AMPLATCH System 50 Receptacle and Paddleboard Connector
- 108-16022—Connector System, .050 [1.27] Centerline FFC Cable
- 108-16025—Connector, ZIF-Line 50
- 108-16029—Shielded Flexible Flat Conductor Cable
- 108-40002—Flexible Flat Conductor Cable

**Application Specifications** describe requirements for using the product in its intended application and/or crimping information. They are intended for the Packaging and Design Engineer and the Machine Setup Person.

- 114-16008—Multiple Crimp Contact for .050 [1.27] Centerline FFC and FEC Cable
- 114-16014—AMP ZIF-Line 50 & 100 PCB Connectors
- 114-25029—AMPMODU System 50 Ribbon Cable Connectors
- 114-25031—AMPMODU System 50 Thru-Hole Connectors
- 114-25035—AMPMODU Surface-Mount Connectors
- 114-25040—AMPMODU System 50 Paddleboard Connectors

**Instruction Sheets** provide instructions for assembling or applying the product. They are intended for the Manufacturing Assembler or Operator.

- 408-6732—Pneumatic Arbor Tool, Part Number 91112-3 (Auto-Cycle)
- 408-7384—Extraction Tool, Part Number 91047
- 408-7763—Pneumatic Arbor Tool, Part Number 91112-2
- 408-7777—Manual Arbor Tool, Part Number 91085-2
- 408-7916—Extraction Tool, Part Number 91200
- 408-9827—Universal Base Assembly, Arbor Tool, Part Number 768338-1
- 408-9872—Connector Specific Kit, Part Number 679167-1, AMPMODU System 50 Receptacle Connectors (.025 [0.64] Centerline Cable)
- 408-9928—Connector Specific Kit, Part Number 679176-1, AMPMODU System 50 Paddleboard Connectors (.025 [0.64] Centerline Cable)
- 408-9564—Hand Crimping Tool Assembly, Part Number 90273-5
- 408-9719—FFC Contact Positioning Hand Tool Kit, Part Number 91292-1

**Note:** All part numbers are RoHS compliant.



## AMPMODU 2mm Connectors (Board to Board)

### Product Facts

- 2.0 x 2.0 [.08 x .08] centerline spacing
- Two-piece, double-row connector system
- Unshrouded header styles include; breakaway and surface-mount
- All headers with 0.5 [.02] square posted contacts
- Surface-mount connectors compatible with standard surface-mount processing (VPR, IR)
- Closed top-entry receptacle assemblies include; vertical mount and right-angle
- Receptacle contacts employ dual cantilever beams for two-point electrical stability
- Duplex (gold/tin-lead) plated posted contacts and receptacle contacts
- Thermoplastic housing material, UL 94V-0 rated
- Recognized under the Component Program of Underwriters Laboratories Inc., File No. E28476
- Certified by Canadian Standards Association, File No. LR7189
- Produced under a Quality Management System certified to ISO 9001



A copy of the certificate is available upon request.

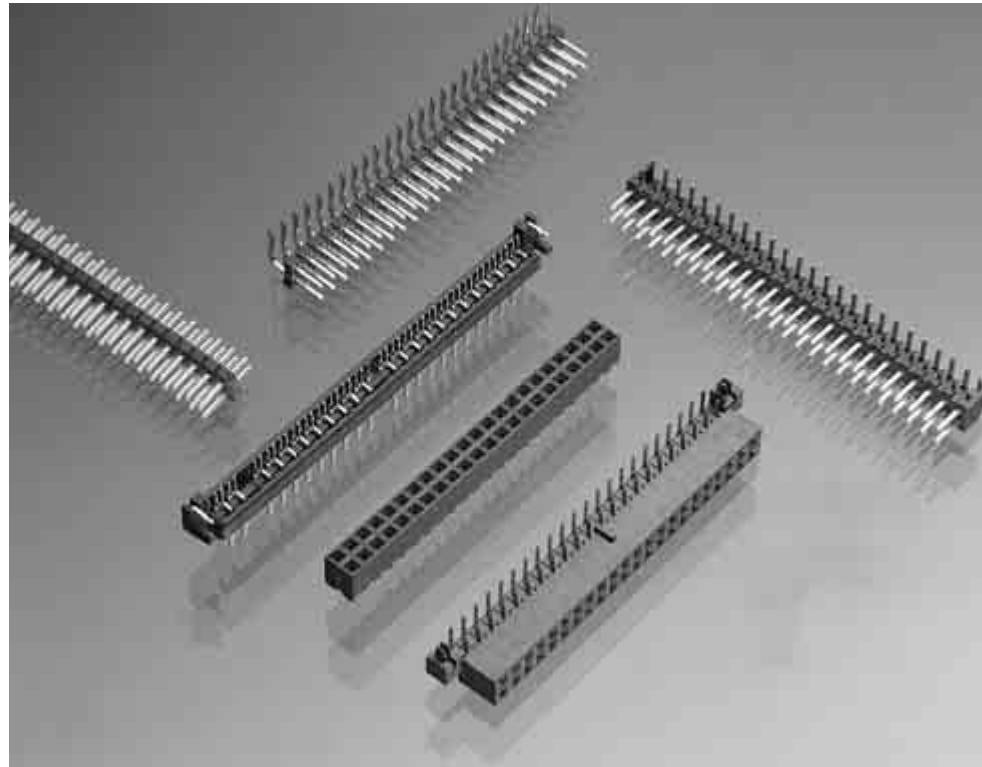

AMPMODU 2mm connectors reliably and economically meet the packaging and inter-connection requirements of today's miniature sophisticated electronics. They are ideal for mobile and portable personal computers and disk drive applications. In today's marketplace, 2mm is expanding over many other industry segments due to space constraints.

This versatile double-row connector system is comprised of various straight and right-angle posted headers for thru-hole and surface mounting and several closed top-entry receptacle assemblies for vertical and horizontal mounting. Headers and receptacle assemblies are available in selected sizes ranging from 4 through 80 positions.

Thru-hole breakaway headers feature brass straight or right-angle posts with a post length of 4.0 [.16] and a lead length of 2.6 [.10].

The receptacle assemblies employ phosphor bronze contacts with dual cantilever beams and built-in anti-overstress. This feature, coupled with duplex (gold/tin-lead) plating of the header posts and receptacle contacts, provide superior electrical performance as well as excellent solderability.

## 2mm Headers, Unshrouded, Double Row, Thru-Hole, Vertical Mount

### 0.5 [.02] Square Straight Posts

#### Material and Finish

**Housing** — Black thermoplastic, UL 94V-0 Rated

**Posted Contacts** — Copper alloy, duplex plated as follows:  
0.00020 [.000008] min. gold on contact area, 0.00254 [.000100] min. tin on solder area, with entire contact underplated 0.00127 [.000050] min. nickel

#### Related Product Data

**Mateable Receptacles** — pages 80-84

**Product Specification**  
108-57197

**Packaging Method** — Loose piece, bag

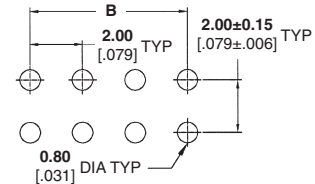
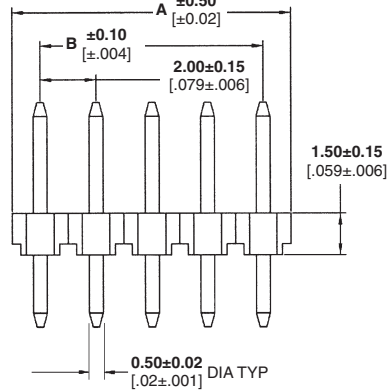
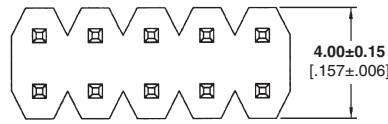

Recommended Solder Pad Layout

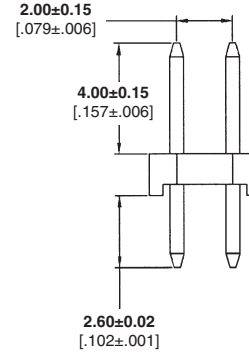

| Position | Dimensions  |             | Part Numbers |             |
|----------|-------------|-------------|--------------|-------------|
|          | A           | B           | Reflow       |             |
|          |             |             | 240°C        | 265°C       |
| 4        | 4.0 [.16]   | 2.0 [.08]   | 1470213-4    | 1734508-4   |
| 6        | 6.0 [.24]   | 4.0 [.16]   | 1470213-6    | 1734508-6   |
| 8        | 8.0 [.32]   | 6.0 [.24]   | 1470213-8    | 1734508-8   |
| 10       | 10.0 [.39]  | 8.0 [.32]   | 1-1470213-0  | 1-1734508-0 |
| 12       | 12.0 [.47]  | 10.0 [.39]  | 1-1470213-2  | 1-1734508-2 |
| 14       | 14.0 [.55]  | 12.0 [.47]  | 1-1470213-4  | 1-1734508-4 |
| 16       | 16.0 [.63]  | 14.0 [.55]  | 1-1470213-6  | 1-1734508-6 |
| 18       | 18.0 [.71]  | 16.0 [.63]  | 1-1470213-8  | 1-1734508-8 |
| 20       | 20.0 [.79]  | 18.0 [.71]  | 2-1470213-0  | 2-1734508-0 |
| 22       | 22.0 [.87]  | 20.0 [.79]  | 2-1470213-2  | 2-1734508-2 |
| 24       | 24.0 [.94]  | 22.0 [.87]  | 2-1470213-4  | 2-1734508-4 |
| 26       | 26.0 [1.02] | 24.0 [.94]  | 2-1470213-6  | 2-1734508-6 |
| 28       | 28.0 [1.10] | 26.0 [1.02] | 2-1470213-8  | 2-1734508-8 |
| 30       | 30.0 [1.18] | 28.0 [1.10] | 3-1470213-0  | 3-1734508-0 |
| 32       | 32.0 [1.26] | 30.0 [1.18] | 3-1470213-2  | 3-1734508-2 |
| 34       | 34.0 [1.34] | 32.0 [1.26] | 3-1470213-4  | 3-1734508-4 |
| 36       | 36.0 [1.42] | 34.0 [1.34] | 3-1470213-6  | 3-1734508-6 |
| 38       | 38.0 [1.50] | 36.0 [1.42] | 3-1470213-8  | 3-1734508-8 |
| 40       | 40.0 [1.57] | 38.0 [1.50] | 4-1470213-0  | 4-1734508-0 |
| 42       | 42.0 [1.65] | 40.0 [1.57] | 4-1470213-2  | 4-1734508-2 |
| 44       | 44.0 [1.73] | 42.0 [1.65] | 4-1470213-4  | 4-1734508-4 |
| 46       | 46.0 [1.81] | 44.0 [1.73] | 4-1470213-6  | 4-1734508-6 |
| 48       | 48.0 [1.89] | 46.0 [1.81] | 4-1470213-8  | 4-1734508-8 |
| 50       | 50.0 [1.97] | 48.0 [1.89] | 5-1470213-0  | 5-1734508-0 |
| 52       | 52.0 [2.05] | 50.0 [1.97] | 5-1470213-2  | 5-1734508-2 |
| 54       | 54.0 [2.13] | 52.0 [2.05] | 5-1470213-4  | 5-1734508-4 |
| 56       | 56.0 [2.20] | 54.0 [2.13] | 5-1470213-6  | 5-1734508-6 |
| 58       | 58.0 [2.28] | 56.0 [2.20] | 5-1470213-8  | 5-1734508-8 |
| 60       | 60.0 [2.36] | 58.0 [2.28] | 6-1470213-0  | 6-1734508-0 |
| 62       | 62.0 [2.44] | 60.0 [2.36] | 6-1470213-2  | 6-1734508-2 |
| 64       | 64.0 [2.52] | 62.0 [2.44] | 6-1470213-4  | 6-1734508-4 |
| 66       | 66.0 [2.60] | 64.0 [2.52] | 6-1470213-6  | 6-1734508-6 |
| 68       | 68.0 [2.68] | 66.0 [2.60] | 6-1470213-8  | 6-1734508-8 |
| 70       | 70.0 [2.76] | 68.0 [2.68] | 7-1470213-0  | 7-1734508-0 |
| 72       | 72.0 [2.83] | 70.0 [2.76] | 7-1470213-2  | 7-1734508-2 |
| 74       | 74.0 [2.91] | 72.0 [2.83] | 7-1470213-4  | 7-1734508-4 |
| 76       | 76.0 [2.99] | 74.0 [2.91] | 7-1470213-6  | 7-1734508-6 |
| 78       | 78.0 [3.07] | 76.0 [2.99] | 7-1470213-8  | 7-1734508-8 |
| 80       | 80.0 [3.15] | 78.0 [3.07] | 8-1470213-0  | 8-1734508-0 |

**Note:** All part numbers are RoHS compliant.

**2mm Headers, Unshrouded, Double Row, Thru-Hole, Right-Angle Mount**

**0.5 [0.02] Square  
Straight Posts**

**Material and Finish**

**Housing** — Black thermoplastic,  
UL 94V-0 Rated, 265°C Process Capable

**Posted Contacts** — Copper alloy,  
duplex plated as follows:  
0.00020 [0.00008] min. gold on contact  
area, 0.00254 [0.00100] min. tin on  
solder area, with entire contact  
underplated 0.00127 [0.00050] min.  
nickel

**Related Product Data**

**Mateable Receptacles** —  
pages 80-84

**Product Specification**  
108-57197

**Packaging Method** — Loose piece,  
bag

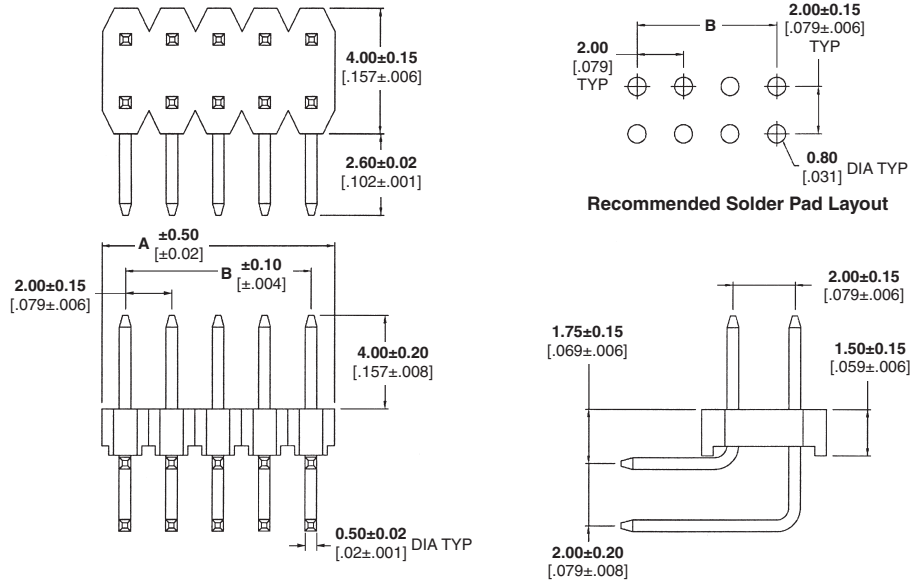

| Position | Dimensions  |             | Part Numbers |
|----------|-------------|-------------|--------------|
|          | A           | B           |              |
| 4        | 4.0 [0.16]  | 2.0 [0.08]  | 1734507-4    |
| 6        | 6.0 [0.24]  | 4.0 [0.16]  | 1734507-6    |
| 8        | 8.0 [0.31]  | 6.0 [0.24]  | 1734507-8    |
| 10       | 10.0 [0.39] | 8.0 [0.31]  | 1-1734507-0  |
| 12       | 12.0 [0.47] | 10.0 [0.39] | 1-1734507-2  |
| 14       | 14.0 [0.55] | 12.0 [0.47] | 1-1734507-4  |
| 16       | 16.0 [0.63] | 14.0 [0.55] | 1-1734507-6  |
| 18       | 18.0 [0.71] | 16.0 [0.63] | 1-1734507-8  |
| 20       | 20.0 [0.79] | 18.0 [0.71] | 2-1734507-0  |
| 22       | 22.0 [0.87] | 20.0 [0.79] | 2-1734507-2  |
| 24       | 24.0 [0.94] | 22.0 [0.87] | 2-1734507-4  |
| 26       | 26.0 [1.02] | 24.0 [0.94] | 2-1734507-6  |
| 28       | 28.0 [1.10] | 26.0 [1.02] | 2-1734507-8  |
| 30       | 30.0 [1.18] | 28.0 [1.10] | 3-1734507-0  |
| 32       | 32.0 [1.26] | 30.0 [1.18] | 3-1734507-2  |
| 34       | 34.0 [1.34] | 32.0 [1.26] | 3-1734507-4  |
| 36       | 36.0 [1.42] | 34.0 [1.34] | 3-1734507-6  |
| 38       | 38.0 [1.50] | 36.0 [1.42] | 3-1734507-8  |
| 40       | 40.0 [1.57] | 38.0 [1.50] | 4-1734507-0  |
| 42       | 42.0 [1.65] | 40.0 [1.57] | 4-1734507-2  |
| 44       | 44.0 [1.73] | 42.0 [1.65] | 4-1734507-4  |
| 46       | 46.0 [1.81] | 44.0 [1.73] | 4-1734507-6  |
| 48       | 48.0 [1.89] | 46.0 [1.81] | 4-1734507-8  |
| 50       | 50.0 [1.97] | 48.0 [1.89] | 5-1734507-0  |
| 52       | 52.0 [2.05] | 50.0 [1.97] | 5-1734507-2  |
| 54       | 54.0 [2.13] | 52.0 [2.05] | 5-1734507-4  |
| 56       | 56.0 [2.20] | 54.0 [2.13] | 5-1734507-6  |
| 58       | 58.0 [2.28] | 56.0 [2.20] | 5-1734507-8  |
| 60       | 60.0 [2.36] | 58.0 [2.28] | 6-1734507-0  |
| 62       | 62.0 [2.44] | 60.0 [2.36] | 6-1734507-2  |
| 64       | 64.0 [2.52] | 62.0 [2.44] | 6-1734507-4  |
| 66       | 66.0 [2.60] | 64.0 [2.52] | 6-1734507-6  |
| 68       | 68.0 [2.68] | 66.0 [2.60] | 6-1734507-8  |
| 70       | 70.0 [2.76] | 68.0 [2.68] | 7-1734507-0  |
| 72       | 72.0 [2.83] | 70.0 [2.76] | 7-1734507-2  |
| 74       | 74.0 [2.91] | 72.0 [2.83] | 7-1734507-4  |
| 76       | 76.0 [2.99] | 74.0 [2.91] | 7-1734507-6  |
| 78       | 78.0 [3.07] | 76.0 [2.99] | 7-1734507-8  |
| 80       | 80.0 [3.15] | 78.0 [3.07] | 8-1734507-0  |

**Note:** All part numbers are RoHS  
compliant.

## 2mm Breakaway Headers, Unshrouded, Double Row, Thru-Hole, Right-Angle Mount

### 0.5 [.02] Square Right-Angle Posts

#### Material and Finish

**Housing** — Black thermoplastic, UL 94V-0 rated

**Posted Contacts** — Brass, duplex plated as follows:

**A** — 0.00020 [.000008] min. gold on contact area, 0.00100 [.000039] min. tin on solder area, with entire contact underplated 0.00130 [.000051] min. nickel

**B** — 0.00076 [.000030] min. gold on contact area, 0.00100 [.000039] min. tin on solder area, with entire contact underplated 0.00130 [.000051] min. nickel

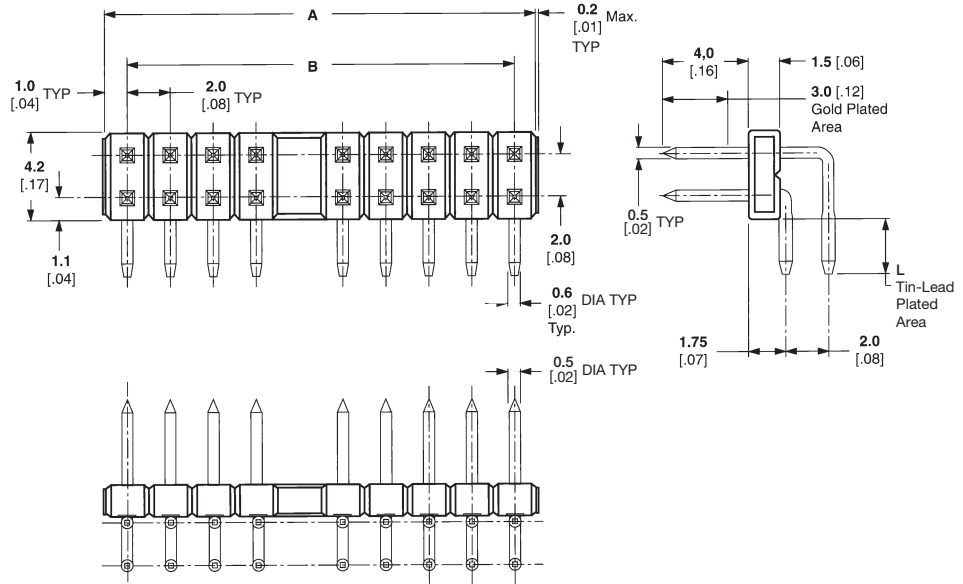

#### Related Product Data

**Mateable Receptacles** — pages 80-84

**Product Specification** 108-5296

**Packaging Method** — Loose piece, bag

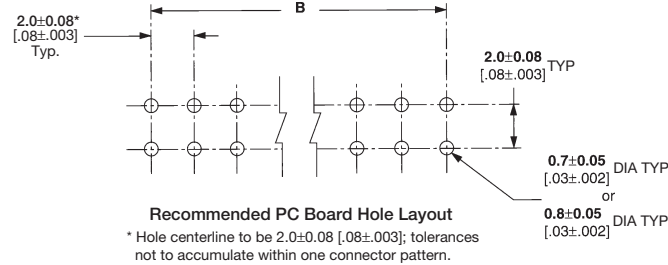

| No. of Positions | Dimensions  |             | Contact Plating<br>Lead Length L = 2.6[.10]** |             |
|------------------|-------------|-------------|---|-------------|
|                  | A           | B           | A   | B           |
| 4                | 4.0 [0.16]  | 2.0 [0.08]  | 5176837-1                                     | 2-5176837-5 |
| 6                | 6.0 [0.24]  | 4.0 [0.16]  | 5176837-2                                     | 2-5176837-6 |
| 8                | 8.0 [0.31]  | 6.0 [0.24]  | 5176837-3                                     | —           |
| 10               | 10.0 [0.39] | 8.0 [0.31]  | 5176837-4                                     | —           |
| 12               | 12.0 [0.47] | 10.0 [0.39] | 5176837-5                                     | —           |
| 14               | 14.0 [0.55] | 12.0 [0.47] | 5176837-6                                     | 3-5176837-0 |
| 16               | 16.0 [0.63] | 14.0 [0.55] | 5176837-7                                     | —           |
| 18               | 18.0 [0.71] | 16.0 [0.63] | —   | 3-5176837-2 |
| 20               | 20.0 [0.79] | 18.0 [0.71] | —   | 3-5176837-3 |
| 22               | 22.0 [0.87] | 20.0 [0.79] | —   | 3-5176837-4 |
| 26               | 26.0 [1.02] | 24.0 [0.94] | 1-5176837-2                                   | —           |
| 30               | 30.0 [1.18] | 28.0 [1.10] | 1-5176837-4                                   | —           |
| 32               | 32.0 [1.26] | 30.0 [1.18] | 1-5176837-5                                   | 3-5176837-9 |
| 34               | 34.0 [1.34] | 32.0 [1.26] | —   | 4-5176837-0 |
| 36               | 36.0 [1.42] | 34.0 [1.34] | —   | 4-5176837-1 |
| 38               | 38.0 [1.50] | 36.0 [1.42] | 1-5176837-8                                   | 4-5176837-2 |
| 40               | 40.0 [1.57] | 38.0 [1.50] | 1-5176837-9                                   | 5-5176837-2 |
| 42               | 42.0 [1.65] | 40.0 [1.57] | 2-5176837-0                                   | 4-5176837-4 |
| 44               | 44.0 [1.73] | 42.0 [1.65] | 2-5176837-1                                   | —           |
| 46               | 46.0 [1.81] | 44.0 [1.73] | 2-5176837-2                                   | 4-5176837-6 |
| 48               | 48.0 [1.89] | 46.0 [1.81] | 2-5176837-3                                   | 4-5176837-7 |
| 50               | 50.0 [1.97] | 48.0 [1.89] | 2-5176837-4                                   | 4-5176837-8 |

4 Breakaway Headers, Unshrouded, Double Row, Thru-Hole Mount

## 2mm Breakaway Headers, Unshrouded, Double Row, Thru-Hole, Vertical Mount

### 0.5 [.02] Square Straight Posts

#### Material and Finish

**Housing** — Black thermoplastic, UL 94V-0 rated

**Posted Contacts** — Brass, duplex plated as follows:

**Plating A** — 0.00020 [.000008] min. gold on contact area, 0.00100 [.000039] min. tin on solder area, with entire contact underplated 0.00130 [.000051] min. nickel

**Plating B** — 0.00076 [.000030] min. gold on contact area, 0.00100 [.000039] min. tin on solder area, with entire contact underplated 0.00130 [.000051] min. nickel

#### Related Product Data

**Mateable Receptacles** — pages 80-84

**Product Specification** 108-5296

**Packaging Method** — Loose piece, bag

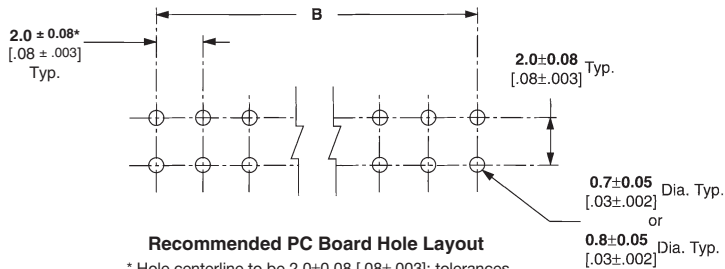
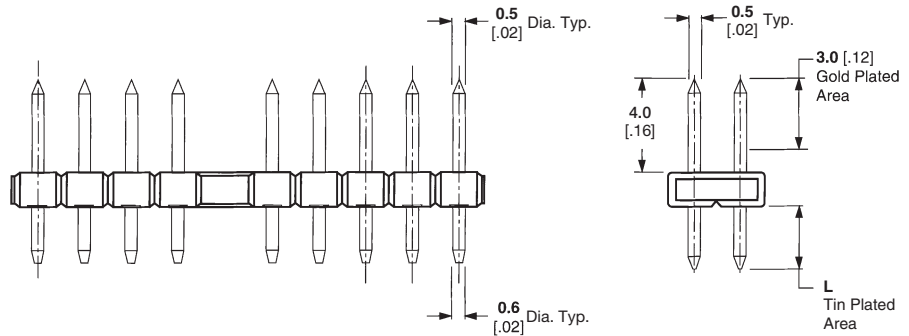
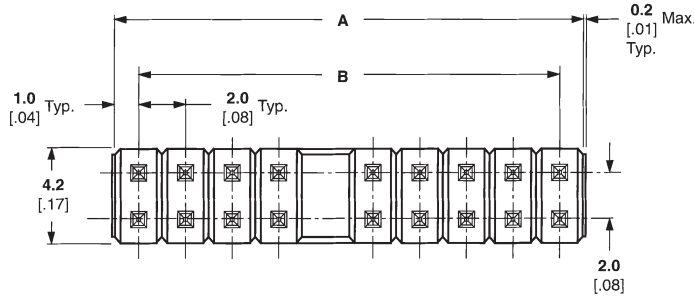

**Recommended PC Board Hole Layout**  
\* Hole centerline to be 2.0±0.08 [.08±.003]; tolerances not to accumulate within one connector pattern.

Breakaway Headers, Unshrouded, Double Row, Thru-Hole Mount

**4**

## 2mm Breakaway Headers, Unshrouded, Double Row, Thru-Hole, Vertical Mount (Continued)

### 0.5 [.02] Square Straight Posts

| No. of Positions | Dimensions  |             | Contact Plating           |             |                           |             |
|------------------|-------------|-------------|---------------------------|-------------|---------------------------|-------------|
|                  |             |             | Lead Length L = 1.5 [.06] |             | Lead Length L = 2.6 [.10] |             |
|                  | A           | B           | Plating A                 | Plating B   | Plating A                 | Plating B   |
| 4                | 4.0 [0.16]  | 2.0 [0.08]  | 5178751-1                 | 2-5178751-5 | 5176264-1                 | 1-5176264-6 |
| 6                | 6.0 [0.24]  | 4.0 [0.16]  | —                         | 2-5178751-6 | 5176264-2                 | 1-5176264-7 |
| 8                | 8.0 [0.31]  | 6.0 [0.24]  | —                         | 2-5178751-7 | 5176264-3                 | 1-5176264-8 |
| 10               | 10.0 [0.39] | 8.0 [0.31]  | 5178751-4                 | 2-5178751-8 | 5176264-4                 | 1-5176264-9 |
| 12               | 12.0 [0.47] | 10.0 [0.39] | —                         | 2-5178751-9 | 5176264-5                 | 2-5176264-0 |
| 14               | 14.0 [0.55] | 12.0 [0.47] | 5178751-6                 | 3-5178751-0 | 5176264-6                 | 2-5176264-1 |
| 16               | 16.0 [0.63] | 14.0 [0.55] | —                         | 3-5178751-1 | 5176264-7                 | 2-5176264-2 |
| 18               | 18.0 [0.71] | 16.0 [0.63] | 5178751-8                 | 3-5178751-2 | 5176264-8                 | 2-5176264-3 |
| 20               | 20.0 [0.79] | 18.0 [0.71] | 5178751-9                 | 3-5178751-3 | 5176264-9                 | 2-5176264-4 |
| 22               | 22.0 [0.87] | 20.0 [0.79] | 1-5178751-0               | 3-5178751-4 | 1-5176264-0               | 2-5176264-5 |
| 24               | 24.0 [0.94] | 22.0 [0.87] | 1-5178751-1               | 3-5178751-5 | 1-5176264-1               | 2-5176264-6 |
| 26               | 26.0 [1.02] | 24.0 [0.94] | 1-5178751-2               | 3-5178751-6 | —                         | —           |
| 28               | 28.0 [1.10] | 26.0 [1.02] | —                         | 3-5178751-7 | 1-5176264-3               | —           |
| 30               | 30.0 [1.18] | 28.0 [1.10] | 1-5178751-4               | 3-5178751-8 | 1-5176264-4               | 2-5176264-9 |
| 32               | 32.0 [1.26] | 30.0 [1.18] | 1-5178751-5               | 3-5178751-9 | 1-5176264-5               | —           |
| 34               | 34.0 [1.34] | 32.0 [1.26] | 1-5178751-6               | 4-5178751-0 | —                         | 4-5176264-0 |
| 36               | 36.0 [1.42] | 34.0 [1.34] | 1-5178751-7               | 4-5178751-1 | 3-5176264-2               | 4-5176264-1 |
| 38               | 38.0 [1.50] | 36.0 [1.42] | 1-5178751-8               | 4-5178751-2 | 3-5176264-3               | —           |
| 40               | 40.0 [1.57] | 38.0 [1.50] | 1-5178751-9               | 4-5178751-3 | 3-5176264-4               | —           |
| 42               | 42.0 [1.65] | 40.0 [1.57] | 2-5178751-0               | 4-5178751-4 | —                         | —           |
| 44               | 44.0 [1.73] | 42.0 [1.65] | 2-5178751-1               | 4-5178751-5 | 3-5176264-6               | 4-5176264-5 |
| 46               | 46.0 [1.81] | 44.0 [1.73] | 2-5178751-2               | 4-5178751-6 | —                         | 4-5176264-6 |
| 48               | 48.0 [1.89] | 46.0 [1.81] | 2-5178751-3               | 4-5178751-7 | —                         | 4-5176264-7 |
| 50               | 50.0 [1.97] | 48.0 [1.89] | 2-5178751-4               | 4-5178751-8 | 3-5176264-9               | 4-5176264-8 |

4 Breakaway Headers, Unshrouded, Double Row, Thru-Hole Mount

**Note:** All part numbers are RoHS compliant.

## 2mm Breakaway Headers, Unshrouded, Double Row, Surface Mount, Vertical Mount

### 0.5 [.02] Square Straight Posts

#### Material and Finish

**Housing** — Black polyphenylene sulfide, UL 94V-0 rated

**Posted Contacts** — Phosphor bronze, plated as follows, Duplex plated 0.00020 [.000008] min. gold on contact area, 0.00200 [.000079] min. tin on solder area, with entire contact underplated 0.00130 [.000051] min. nickel

#### Related Product Data

**Mateable Receptacles** — pages 80-84

**Product Specification** 108-51001

**Packaging Method** — Tape & Reel

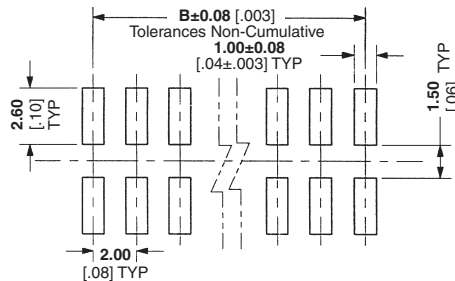
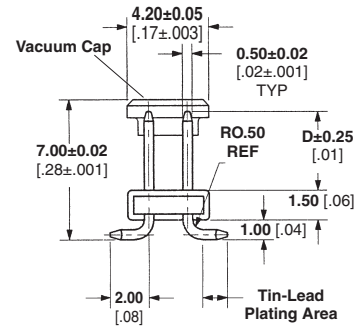
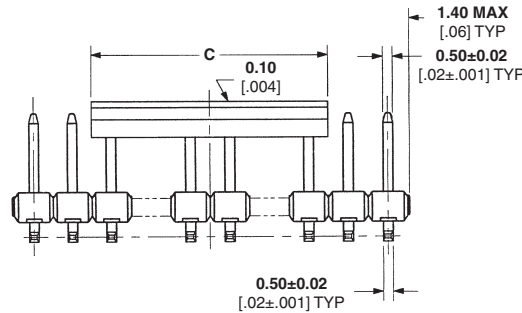
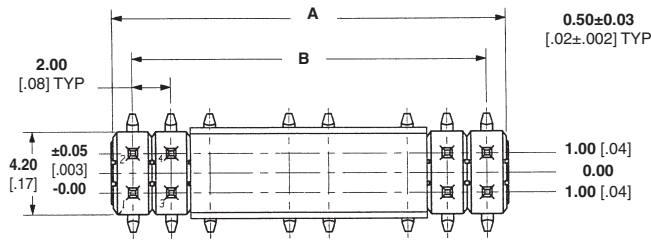

Recommended Solder Pad Layout

| No. of Positions | Dimensions  |             |            | Part Numbers |
|------------------|-------------|-------------|------------|--------------|
|                  | A           | B           | C          |              |
| 4                | 4.0 [0.16]  | 2.0 [0.08]  | 4.0 [0.16] | 5084476-1    |
| 6                | 6.0 [0.24]  | 4.0 [0.16]  | 6.0 [0.24] | 5084476-2    |
| 12               | 12.0 [0.47] | 10.0 [0.39] | 5.0 [0.20] | 5084476-7    |
| 16               | 16.0 [0.63] | 14.0 [0.55] | 8.0 [0.31] | 5084476-3    |

**Note:** All part numbers are RoHS compliant.

**2mm Breakaway Headers, Unshrouded, Double Row, Surface Mount, Vertical Mount** (Continued)

**0.5 [.02] Square Straight Posts**

**Material and Finish**

**Housing** — Black polyphenylene sulfide, UL 94V-0 rated

**Posted Contacts** — Phosphor bronze, plated as follows, Duplex plated 0.0076 [.000030] min. gold on contact area, 0.00254-0.00406 [.000100-.000160] min. tin on solder area, with entire contact underplated 0.00127 [.000050] min. nickel

**Related Product Data**

**Mateable Receptacles** — pages 80-84

**Product Specification** 108-18544

**Packaging Method** — Tape & Reel

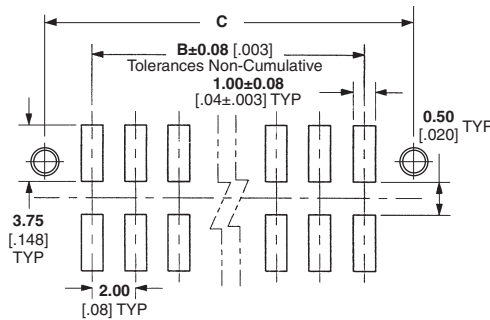
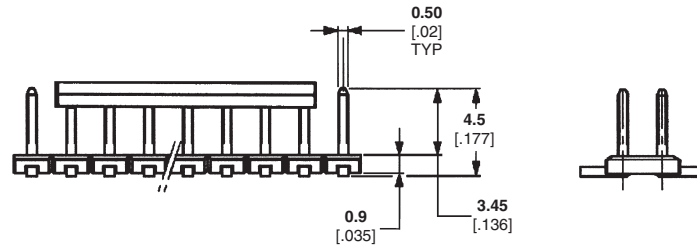
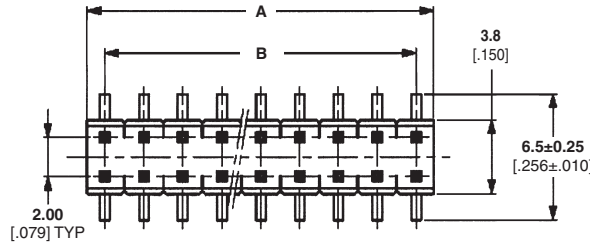

**Recommended Solder Pad Layout**

| No. of Positions | Dimensions  |             |              | Part Numbers |
|------------------|-------------|-------------|--------------|--------------|
|                  | A           | B           | C            |              |
| 4                | 4.0 [0.16]  | 2.0 [0.08]  | 7.60 [0.30]  | 966926-2     |
| 6                | 6.0 [0.24]  | 4.0 [0.16]  | 9.60 [0.38]  | 966926-3     |
| 8                | 8.0 [0.31]  | 6.0 [0.24]  | 11.60 [0.46] | 966926-4     |
| 10               | 10.0 [0.39] | 8.0 [0.31]  | 13.60 [0.53] | 966926-5     |
| 12               | 12.0 [0.47] | 10.0 [0.39] | 15.60 [0.61] | 966926-6     |
| 14               | 14.0 [0.55] | 12.0 [0.47] | 17.60 [0.69] | 966926-7     |
| 16               | 16.0 [0.63] | 14.0 [0.55] | 19.60 [0.77] | 966926-8     |
| 18               | 18.0 [0.71] | 16.0 [0.63] | 21.60 [0.85] | 966926-9     |
| 20               | 20.0 [0.79] | 18.0 [0.71] | 23.60 [0.93] | 1-966926-0   |
| 22               | 22.0 [0.87] | 20.0 [0.79] | 25.60 [1.01] | 1-966926-1   |
| 24               | 24.0 [0.94] | 22.0 [0.87] | 27.60 [1.09] | 1-966926-2   |

**Note:** All part numbers are RoHS compliant.



**2mm Stacking Header, Unshrouded, Double Row, Thru-Hole, Vertical Mount**

**0.5 [.02] Square Straight Posts**

**12 Position**  
**Part Number 1734770-1**

**Material and Finish**

**Housing** — Black thermoplastic, UL 94 V-0 Rated

**Posted Contacts** — Copper alloy, duplex plated as follows:

Gold flash all over contact underplated 0.00127 [.000050] min. nickel

**Related Product Data**

**Mateable Receptacles** — pages 80-84

**Product Specification** 108-57331

**Packaging Method** — Loose piece, bag

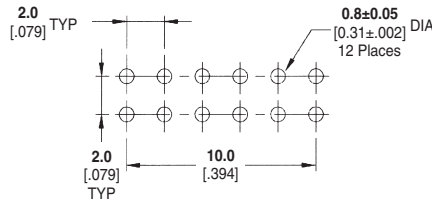
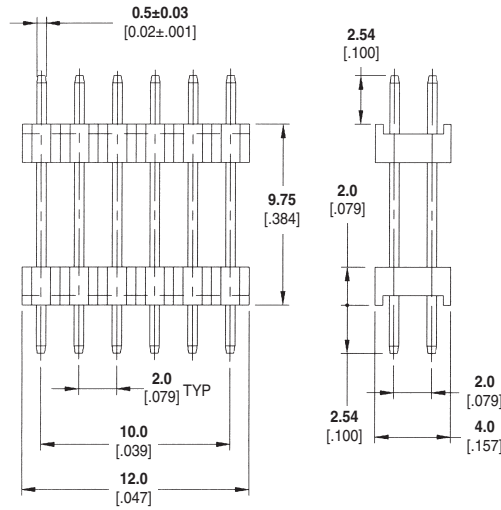

2.0 Pitch Vertical

4

**Note:** All part numbers are RoHS compliant.

**2mm Headers, Shrouded, Double Row, Thru-Hole, Right-Angle Mount**

**0.5 [.02] Square Right-Angle Posts**

**26 Position**  
**Part Number 5084780-1**

**Material and Finish**

**Housing** — High temperature, black thermoplastic, UL 94 V-O Rated

**Posted Contacts** — Copper alloy, duplex plated as follows: 0.00038 [.000015] min. gold on contact area, 0.00254 [.000100] min. tin on solder area, with entire contact underplated 0.00127 [.000050] min. nickel

**Related Product Data**

**Mateable Receptacles** — pages 80 and 84

**Product Specification**  
108-5296

**Packaging Method** — Tube

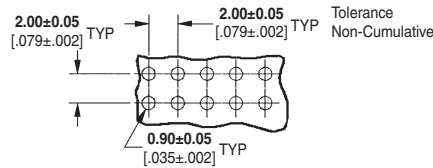
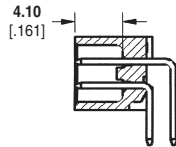
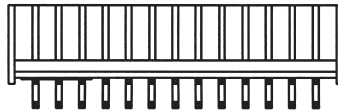
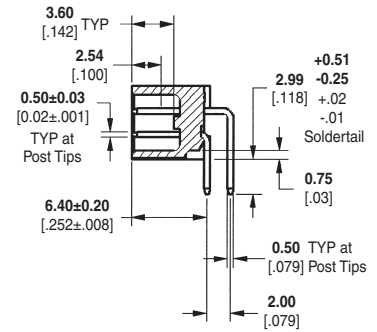
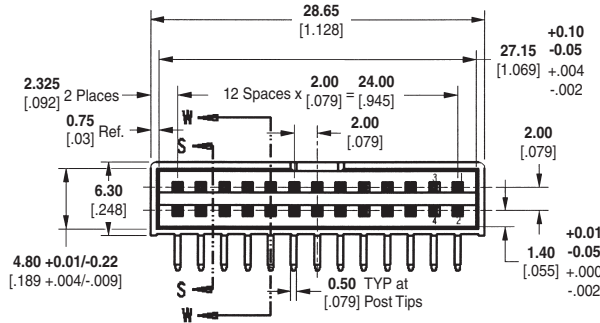
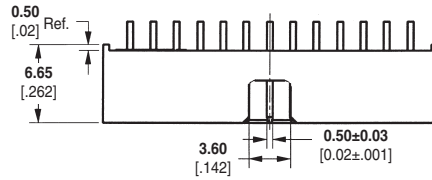

**Recommended PCB Layout**

**Note:** All part numbers are RoHS compliant.

2.0 Pitch Right-Angle

4

**2mm Headers, Shrouded, Double Row, Thru-Hole, Right-Angle Mount**

(Continued)

**0.5 [0.02] Square Right-Angle Posts**

**Material and Finish**

**Housing** — Natural color thermoplastic, UL 94 V-0 Rated

**Posted Contacts** — Brass, plated as follows:

0.00020 [0.00008] min. gold on contact area, with 0.00254 [0.00010] tin on soldertails, with entire contact underplated 0.00127 [0.00050] min. nickel

**Related Product Data**

**Mateable Receptacles** — pages 80 and 84

**Product Specification** 108-57197

**Packaging Method** — Tubes

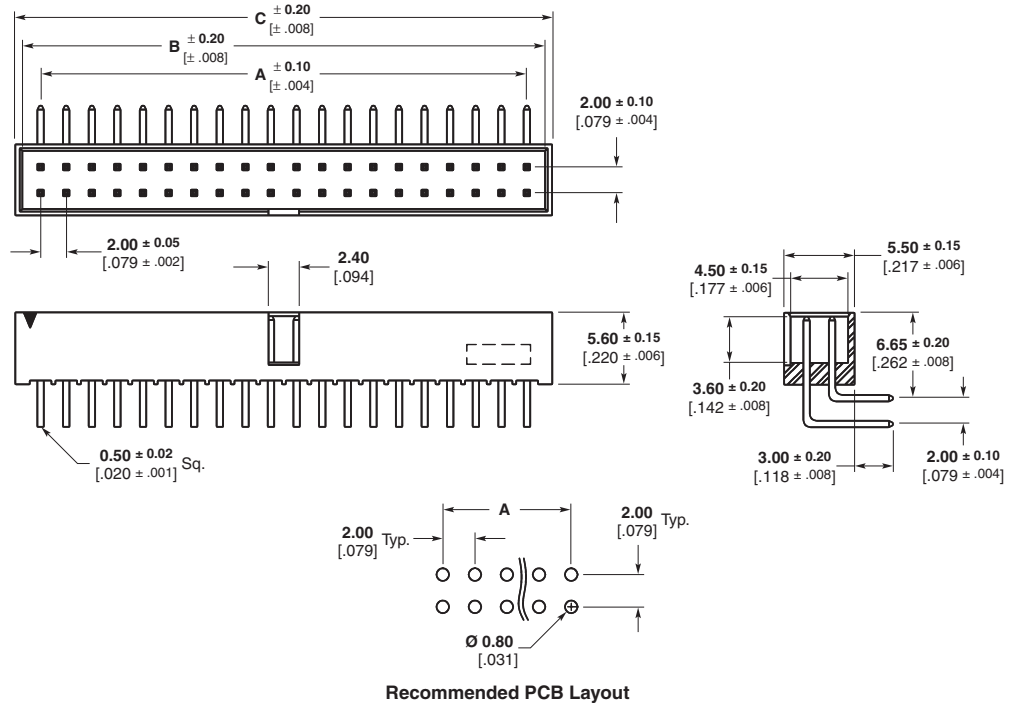

Recommended PCB Layout

| No. of Positions | Dimensions  |              |              | Part Numbers |
|------------------|-------------|--------------|--------------|--------------|
|                  | A           | B            | C            |              |
| 8                | 6.0 [0.24]  | 8.85 [0.35]  | 9.95 [0.39]  | 1734493-8    |
| 10               | 8.0 [0.31]  | 10.85 [0.43] | 11.95 [0.47] | 1-1734493-0  |
| 12               | 10.0 [0.39] | 12.85 [0.51] | 13.95 [0.55] | 1-1734493-2  |
| 14               | 12.0 [0.47] | 14.85 [0.58] | 15.95 [0.63] | 1-1734493-4  |
| 16               | 14.0 [0.55] | 16.85 [0.66] | 17.95 [0.71] | 1-1734493-6  |
| 18               | 16.0 [0.63] | 18.85 [0.74] | 19.95 [0.79] | 1-1734493-8  |
| 20               | 18.0 [0.71] | 20.85 [0.82] | 21.95 [0.86] | 2-1734493-0  |
| 22               | 20.0 [0.79] | 22.85 [0.90] | 23.95 [0.94] | 2-1734493-2  |
| 24               | 22.0 [0.87] | 24.85 [0.98] | 25.95 [1.02] | 2-1734493-4  |
| 26               | 24.0 [0.94] | 26.85 [1.06] | 27.95 [1.10] | 2-1734493-6  |
| 28               | 26.0 [1.02] | 28.85 [1.14] | 29.95 [1.18] | 2-1734493-8  |
| 30               | 28.0 [1.10] | 30.85 [1.21] | 31.95 [1.26] | 3-1734493-0  |
| 32               | 30.0 [1.18] | 32.85 [1.29] | 33.95 [1.34] | 3-1734493-2  |
| 34               | 32.0 [1.26] | 34.85 [1.37] | 35.95 [1.42] | 3-1734493-4  |
| 36               | 34.0 [1.34] | 36.85 [1.45] | 37.95 [1.49] | 3-1734493-6  |
| 38               | 36.0 [1.42] | 38.85 [1.53] | 39.95 [1.57] | 3-1734493-8  |
| 40               | 38.0 [1.50] | 40.85 [1.61] | 41.95 [1.65] | 4-1734493-0  |
| 42               | 40.0 [1.57] | 42.85 [1.69] | 43.95 [1.73] | 4-1734493-2  |
| 44               | 42.0 [1.65] | 44.85 [1.77] | 45.95 [1.81] | 4-1734493-4  |
| 46               | 44.0 [1.73] | 46.85 [1.84] | 47.95 [1.89] | 4-1734493-6  |
| 48               | 46.0 [1.81] | 48.85 [1.92] | 49.95 [1.97] | 4-1734493-8  |
| 50               | 48.0 [1.89] | 50.85 [2.00] | 51.95 [2.05] | 5-1734493-0  |
| 52               | 50.0 [1.97] | 52.85 [2.08] | 53.95 [2.12] | 5-1734493-2  |
| 54               | 52.0 [2.05] | 54.85 [2.16] | 55.95 [2.20] | 5-1734493-4  |
| 56               | 54.0 [2.13] | 56.85 [2.34] | 57.95 [2.28] | 5-1734493-6  |
| 58               | 56.0 [2.20] | 58.85 [2.32] | 59.95 [2.36] | 5-1734493-8  |
| 60               | 58.0 [2.28] | 60.85 [2.40] | 61.95 [2.44] | 6-1734493-0  |
| 62               | 60.0 [2.36] | 62.85 [2.47] | 63.95 [2.52] | 6-1734493-2  |
| 64               | 62.0 [2.44] | 64.85 [2.55] | 65.95 [2.60] | 6-1734493-4  |

**Note:** All part numbers are RoHS compliant.

**2mm Headers, Shrouded, Double Row, Surface Mount, Vertical Mount**

**0.5 [.02] Square Posts**

**Material and Finish**

**Housing** — Black color, PA9T (Nylon 9T), UL 94 V-0 Rated

**Posted Contacts** — Brass, plated as follows:

0.00076 [.000003] min. gold on contact area, with 0.00254 [.00010] matte tin on soldertails, with entire contact underplated 0.00127 [.000050] min. nickel

**Related Product Data**

**Mateable Receptacles** — pages 80, 81, and 84

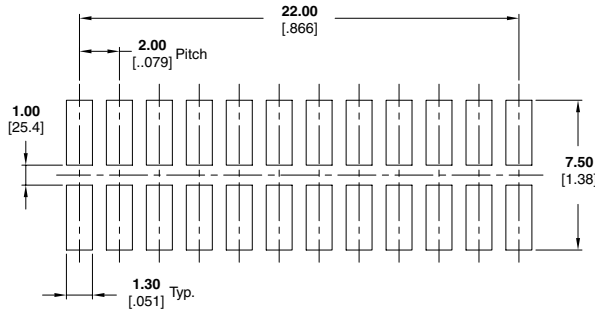
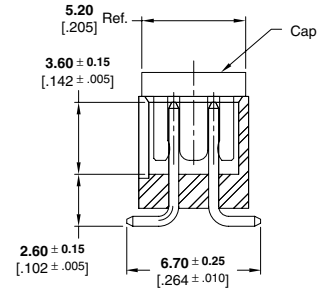
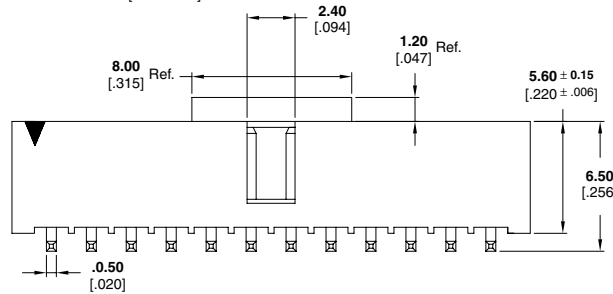
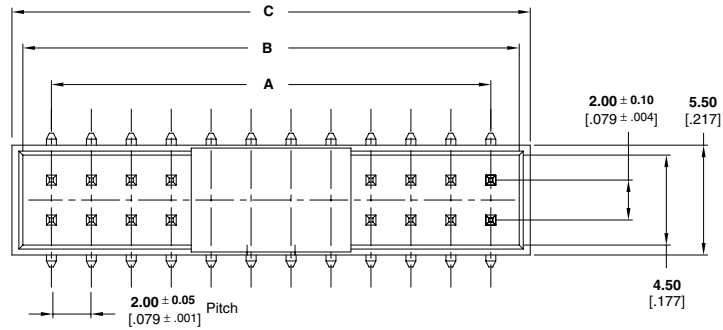

**Recommended PCB Layout**

| No. of Positions | Dimensions  |              |              | Part Numbers |
|------------------|-------------|--------------|--------------|--------------|
|                  | A           | B            | C            |              |
| 8                | 6.0 [0.24]  | 8.85 [0.35]  | 9.95 [0.39]  | 2041068-8    |
| 10               | 8.0 [0.31]  | 10.85 [0.43] | 11.95 [0.47] | 1-2041068-0  |
| 12               | 10.0 [0.39] | 12.85 [0.51] | 13.95 [0.55] | 1-2041068-2  |
| 14               | 12.0 [0.47] | 14.85 [0.58] | 15.95 [0.63] | 1-2041068-4  |
| 16               | 14.0 [0.55] | 16.85 [0.66] | 17.95 [0.71] | 1-2041068-6  |
| 18               | 16.0 [0.63] | 18.85 [0.74] | 19.95 [0.79] | 1-2041068-8  |
| 20               | 18.0 [0.71] | 20.85 [0.82] | 21.95 [0.86] | 2-2041068-0  |
| 22               | 20.0 [0.79] | 22.85 [0.90] | 23.95 [0.94] | 2-2041068-2  |
| 24               | 22.0 [0.87] | 24.85 [0.98] | 25.95 [1.02] | 2-2041068-4  |
| 26               | 24.0 [0.94] | 26.85 [1.06] | 27.95 [1.10] | 2-2041068-6  |
| 28               | 26.0 [1.02] | 28.85 [1.14] | 29.95 [1.18] | 2-2041068-8  |
| 30               | 28.0 [1.10] | 30.85 [1.21] | 31.95 [1.26] | 3-2041068-0  |
| 32               | 30.0 [1.18] | 32.85 [1.29] | 33.95 [1.34] | 3-2041068-2  |
| 34               | 32.0 [1.26] | 34.85 [1.37] | 35.95 [1.42] | 3-2041068-4  |
| 36               | 34.0 [1.34] | 36.85 [1.45] | 37.95 [1.49] | 3-2041068-6  |
| 38               | 36.0 [1.42] | 38.85 [1.53] | 39.95 [1.57] | 3-2041068-8  |
| 40               | 38.0 [1.50] | 40.85 [1.61] | 41.95 [1.65] | 4-2041068-0  |
| 42               | 40.0 [1.57] | 42.85 [1.69] | 43.95 [1.73] | 4-2041068-2  |
| 44               | 42.0 [1.65] | 44.85 [1.77] | 45.95 [1.81] | 4-2041068-4  |
| 46               | 44.0 [1.73] | 46.85 [1.84] | 47.95 [1.89] | 4-2041068-6  |
| 48               | 46.0 [1.81] | 48.85 [1.92] | 49.95 [1.97] | 4-2041068-8  |
| 50               | 48.0 [1.89] | 50.85 [2.00] | 51.95 [2.05] | 5-2041068-0  |

**Note:** All part numbers are RoHS compliant.

2.0 Pitch Vertical

4

**2mm Headers, Shrouded, Double Row, Surface Mount, Vertical Mount**

(Continued)

**0.5 [.02] Square Straight Posts**

**Material and Finish**

**Housing** — Black high temperature thermoplastic, UL 94 V-O Rated

**Posted Contacts** — Phosphor Bronze, duplex plated as follows:

0.00076(0.000030) min. gold on contact area, 0.00381(.000150) min. tin on solder area, with entire contact underplated 0.00127(.000050) min. nickel

**Product Specification**

108-57328

**Packaging Method** — Tape and reel

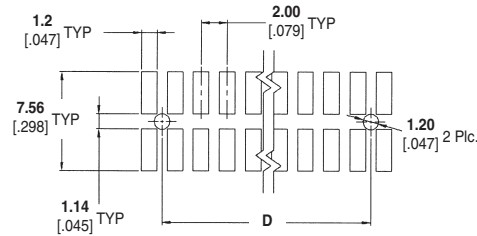
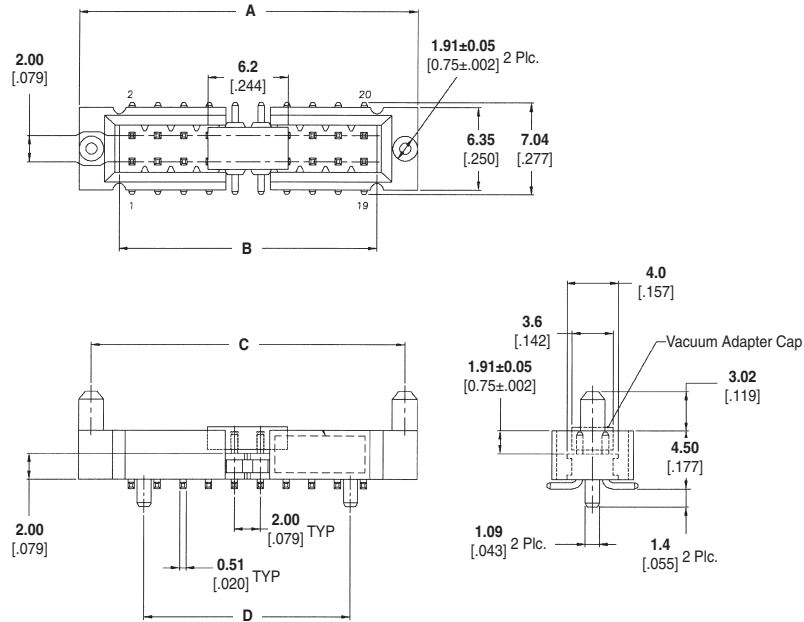

**Recommended PCB Layout**

| No. of Positions | Dimensions  |             |             |             | Part Numbers |
|------------------|-------------|-------------|-------------|-------------|--------------|
|                  | A           | B           | C           | D           |              |
| 20               | 26.2 [1.03] | 20.0 [0.79] | 24.3 [0.96] | 16.0 [.63]  | 2-1734569-0  |
| 30               | 36.2 [1.43] | 30.0 [1.18] | 34.3 [1.35] | 26.0 [1.02] | 3-1734569-0  |

**Note:** All part numbers are RoHS compliant.

**4**  
 Receptacle Assemblies,  
 Double Row, Vertical Mount with  
 Vacuum Adapter Cap

**2mm Headers, Shrouded, Double Row, Thru-Hole, Vertical Mount**

**0.5 [.02] Square Straight Posts with Cable Shroud**

**Material and Finish**

**Housing** — Black thermoplastic, UL 94 V-0 Rated

**Posted Contacts** — Brass, duplex plated as follows:  
0.00254 [.000100] min. tin on contact area, with entire contact underplated  
0.00127 [.000050] min. nickel

**Related Product Data**

**Mateable Receptacles** — See Drawings 1470106 Contacts and 1470107 Housing

**Product Specification**  
108-57217

**Packaging Method** — Loose piece, bag

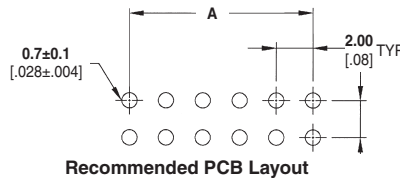
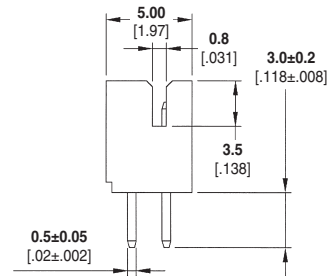
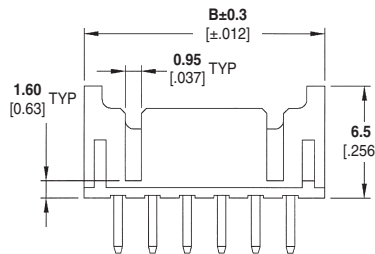
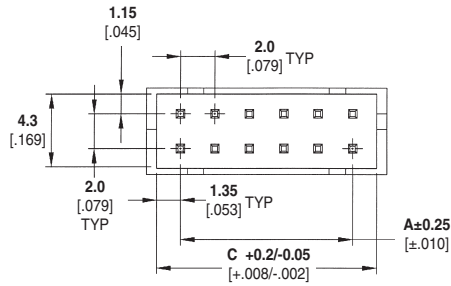

| No. of Position | Dimensions  |             |              | Part Numbers |
|-----------------|-------------|-------------|--------------|--------------|
|                 | A           | B           | C            |              |
| 6               | 4.0 [0.16]  | 8.0 [0.31]  | 6.74 [0.26]  | 1470109-6    |
| 8               | 6.0 [0.24]  | 10.0 [0.39] | 8.74 [0.34]  | 1470109-8    |
| 10              | 8.0 [0.31]  | 12.0 [0.47] | 10.74 [0.42] | 1-1470109-0  |
| 12              | 10.0 [0.39] | 14.0 [0.55] | 12.74 [0.50] | 1-1470109-2  |
| 14              | 12.0 [0.47] | 16.0 [0.63] | 14.74 [0.58] | 1-1470109-4  |
| 16              | 14.0 [0.55] | 18.0 [0.71] | 16.74 [0.66] | 1-1470109-6  |
| 18              | 16.0 [0.63] | 20.0 [0.79] | 18.74 [0.74] | 1-1470109-8  |
| 20              | 18.0 [0.71] | 22.0 [0.87] | 20.74 [0.82] | 2-1470109-0  |
| 22              | 20.0 [0.79] | 24.0 [0.94] | 22.74 [0.89] | 2-1470109-2  |
| 24              | 22.0 [0.87] | 26.0 [1.02] | 24.74 [0.97] | 2-1470109-4  |
| 26              | 24.0 [0.94] | 28.0 [1.10] | 26.74 [1.05] | 2-1470109-6  |
| 28              | 26.0 [1.02] | 30.0 [1.18] | 28.74 [1.13] | 2-1470109-8  |
| 30              | 28.0 [1.10] | 32.0 [1.26] | 30.74 [1.21] | 3-1470109-0  |
| 32              | 30.0 [1.18] | 34.0 [1.34] | 32.74 [1.29] | 3-1470109-2  |

**Note:** All part numbers are RoHS compliant.

Box Header  
**4**

**2mm Headers, Shrouded, Double Row, Thru-Hole, Right-Angle Mount**

**0.5 [ .02 ] Square Right-Angle Posts with Cable Shroud**

**Material and Finish**

**Housing** — Black thermoplastic, UL 94 V-0 Rated

**Posted Contacts** — Brass, duplex plated as follows:  
0.00254 [ .000100 ] min. tin on contact area, with entire contact underplated  
0.00127 [ .000050 ] min. nickel

**Related Product Data**

**Mateable Receptacles** — See Drawings 1470106 Contacts and 1470107 Housing

**Product Specification**  
108-57217

**Packaging Method** — Loose piece, bag

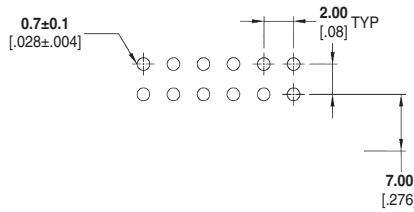
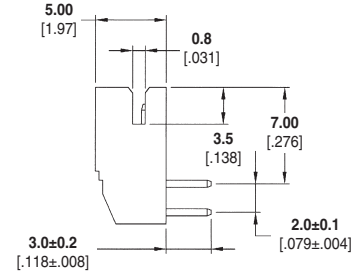
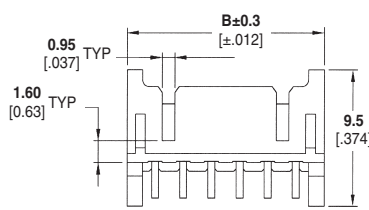
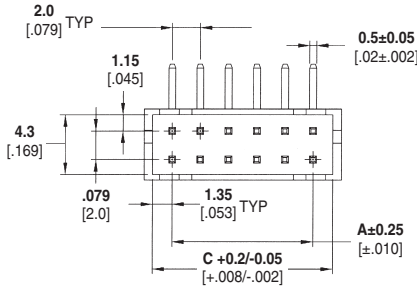

**Recommended PCB Layout**

| No. of Position | Dimensions    |                |                | Part Numbers |
|-----------------|---------------|----------------|----------------|--------------|
|                 | A             | B              | C              |              |
| 6               | 4.0 [ 0.16 ]  | 8.00 [ 0.31 ]  | 6.74 [ 0.26 ]  | 1470108-6    |
| 8               | 6.0 [ 0.24 ]  | 10.00 [ 0.39 ] | 8.74 [ 0.34 ]  | 1470108-8    |
| 10              | 8.0 [ 0.32 ]  | 12.00 [ 0.47 ] | 10.74 [ 0.42 ] | 1-1470108-0  |
| 12              | 10.0 [ 0.39 ] | 14.00 [ 0.55 ] | 12.74 [ 0.50 ] | 1-1470108-2  |
| 14              | 12.0 [ 0.47 ] | 16.00 [ 0.63 ] | 14.74 [ 0.58 ] | 1-1470108-4  |
| 16              | 18.0 [ 0.71 ] | 18.00 [ 0.71 ] | 16.74 [ 0.66 ] | 1-1470108-6  |
| 18              | 14.0 [ 0.55 ] | 20.00 [ 0.79 ] | 18.74 [ 0.74 ] | 1-1470108-8  |
| 20              | 16.0 [ 0.63 ] | 22.00 [ 0.87 ] | 20.74 [ 0.82 ] | 2-1470108-0  |
| 22              | 22.0 [ 0.87 ] | 24.00 [ 0.94 ] | 22.74 [ 0.89 ] | 2-1470108-2  |
| 24              | 20.0 [ 0.79 ] | 26.00 [ 1.02 ] | 24.74 [ 0.97 ] | 2-1470108-4  |
| 26              | 24.0 [ 0.94 ] | 28.00 [ 1.10 ] | 26.74 [ 1.05 ] | 2-1470108-6  |
| 28              | 28.0 [ 1.10 ] | 30.00 [ 1.18 ] | 28.74 [ 1.13 ] | 2-1470108-8  |
| 30              | 26.0 [ 1.02 ] | 32.00 [ 1.26 ] | 30.74 [ 1.21 ] | 3-1470108-0  |
| 32              | 30.0 [ 1.18 ] | 34.00 [ 1.34 ] | 32.74 [ 1.29 ] | 3-1470108-2  |

**Note:** All part numbers are RoHS compliant.

## 2mm Centerline Receptacles, Double Row, Thru-Hole, Vertical Mount

### Receptacle, Thru-Hole, Vertical

#### Material and Finish

**Housing** — Black thermoplastic, UL 94 V-0 Rated, 245°C Reflow

**Contacts** — Copper alloy, plated as follows:

**A** — 0.00020 [.000008] min. gold on contact area, 0.00203 [.000080] min. tin on solder area, with entire contact underplated 0.00127 [.000050] min. nickel

**B** — 0.00076 [.000030] min. gold on contact area, 0.00203 [.000080] min. tin on solder area, with entire contact underplated 0.00127 [.000050] min. nickel

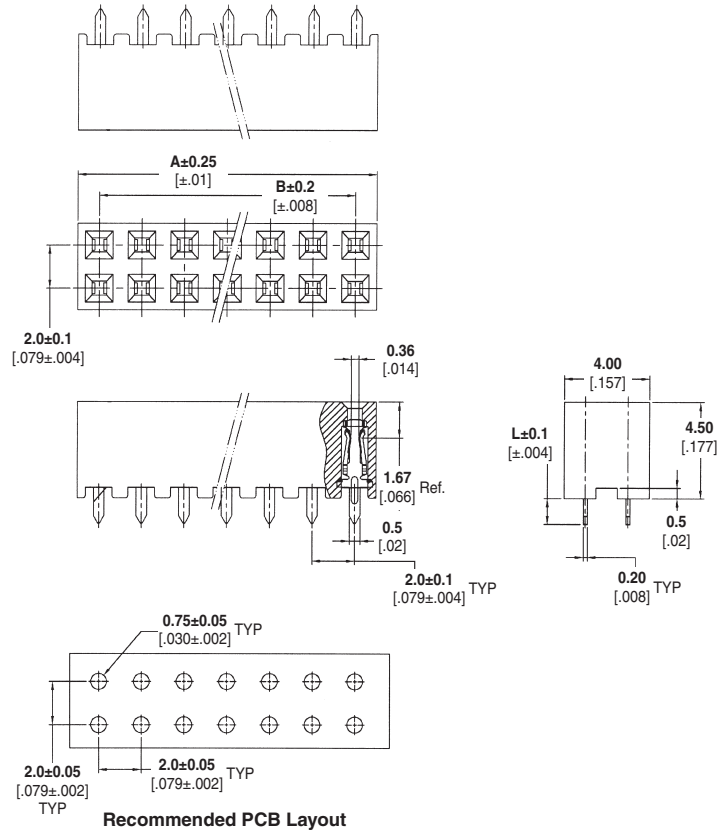

#### Related Product Data

**Mateable Headers** — pages 66-76, 78, 79

**Product Specification** 108-57197

**Packaging Method** — Tray

2.0 Mount Type w/PickUp

4

| No. of Positions | Dimensions   |              | Part Numbers                          |                                       |                                       |                                       |
|------------------|--------------|--------------|---------------------------------------|---------------------------------------|---------------------------------------|---------------------------------------|
|                  |              |              | Plating A                             |                                       | Plating B                             |                                       |
|                  |              |              | Dim. L<br>1.2+/-0.1<br>(.047+/-0.004) | Dim. L<br>2.6+/-0.1<br>(.102+/-0.004) | Dim. L<br>1.2+/-0.1<br>(.047+/-0.004) | Dim. L<br>2.6+/-0.1<br>(.102+/-0.004) |
| 4                | 4.0 [.157]   | 2.0 [.079]   | 1470209-1                             | 2-1470209-5                           | 5-1470209-1                           | 7-1470209-5                           |
| 6                | 6.0 [.236]   | 4.0 [.157]   | 1470209-2                             | 2-1470209-6                           | 5-1470209-2                           | 7-1470209-6                           |
| 8                | 8.0 [.315]   | 6.0 [.236]   | 1470209-3                             | 2-1470209-7                           | 5-1470209-3                           | 7-1470209-7                           |
| 10               | 10.0 [.394]  | 8.0 [.315]   | 1470209-4                             | 2-1470209-8                           | 5-1470209-4                           | 7-1470209-8                           |
| 12               | 12.0 [.472]  | 10.0 [.394]  | 1470209-5                             | 2-1470209-9                           | 5-1470209-5                           | 7-1470209-9                           |
| 14               | 14.0 [.551]  | 12.0 [.472]  | 1470209-6                             | 3-1470209-0                           | 5-1470209-6                           | 8-1470209-0                           |
| 16               | 16.0 [.630]  | 14.0 [.551]  | 1470209-7                             | 3-1470209-1                           | 5-1470209-7                           | 8-1470209-1                           |
| 18               | 18.0 [.709]  | 16.0 [.630]  | 1470209-8                             | 3-1470209-2                           | 5-1470209-8                           | 8-1470209-2                           |
| 20               | 20.0 [.787]  | 18.0 [.709]  | 1470209-9                             | 3-1470209-3                           | 5-1470209-9                           | 8-1470209-3                           |
| 22               | 22.0 [.866]  | 20.0 [.787]  | 1-1470209-0                           | 3-1470209-4                           | 6-1470209-0                           | 8-1470209-4                           |
| 24               | 24.0 [.945]  | 22.0 [.866]  | 1-1470209-1                           | 3-1470209-5                           | 6-1470209-1                           | 8-1470209-5                           |
| 26               | 26.0 [1.024] | 24.0 [.945]  | 1-1470209-2                           | 3-1470209-6                           | 6-1470209-2                           | 8-1470209-6                           |
| 28               | 28.0 [1.102] | 26.0 [1.024] | 1-1470209-3                           | 3-1470209-7                           | 6-1470209-3                           | 8-1470209-7                           |
| 30               | 30.0 [1.181] | 28.0 [1.102] | 1-1470209-4                           | 3-1470209-8                           | 6-1470209-4                           | 8-1470209-8                           |
| 32               | 32.0 [1.260] | 30.0 [1.181] | 1-1470209-5                           | 3-1470209-9                           | 6-1470209-5                           | 8-1470209-9                           |
| 34               | 34.0 [1.339] | 32.0 [1.260] | 1-1470209-6                           | 4-1470209-0                           | 6-1470209-6                           | 9-1470209-0                           |
| 36               | 36.0 [1.417] | 34.0 [1.339] | 1-1470209-7                           | 4-1470209-1                           | 6-1470209-7                           | 9-1470209-1                           |
| 38               | 38.0 [1.496] | 36.0 [1.417] | 1-1470209-8                           | 4-1470209-2                           | 6-1470209-8                           | 9-1470209-2                           |
| 40               | 40.0 [1.575] | 38.0 [1.496] | 1-1470209-9                           | 4-1470209-3                           | 6-1470209-9                           | 9-1470209-3                           |
| 42               | 42.0 [1.654] | 40.0 [1.575] | 2-1470209-0                           | 4-1470209-4                           | 7-1470209-0                           | 9-1470209-4                           |
| 44               | 44.0 [1.732] | 42.0 [1.654] | 2-1470209-1                           | 4-1470209-5                           | 7-1470209-1                           | 9-1470209-5                           |
| 46               | 46.0 [1.811] | 44.0 [1.732] | 2-1470209-2                           | 4-1470209-6                           | 7-1470209-2                           | 9-1470209-6                           |
| 48               | 48.0 [1.890] | 46.0 [1.811] | 2-1470209-3                           | 4-1470209-7                           | 7-1470209-3                           | 9-1470209-7                           |
| 50               | 50.0 [1.969] | 48.0 [1.890] | 2-1470209-4                           | 4-1470209-8                           | 7-1470209-4                           | 9-1470209-8                           |

**Note:** All part numbers are RoHS compliant.



**2mm Centerline Receptacles, Double Row, Thru-Hole, Vertical Mount (Continued)**

**Receptacle, Thru-Hole, Vertical**

**Material and Finish**

**Housing** — Black thermoplastic, UL 94 V-O Rated, 265°C Process Capable

**Contacts** — Copper alloy, plated as follows:

**A** — 0.00020 [.000008] min. gold on contact area, 0.00203 [.000080] min. tin on solder area, with entire contact underplated 0.00127 [.000050] min. nickel

**B** — 0.00076 [.000030] min. gold on contact area, 0.00203 [.000080] min. tin on solder area, with entire contact underplated 0.00127 [.000050] min. nickel

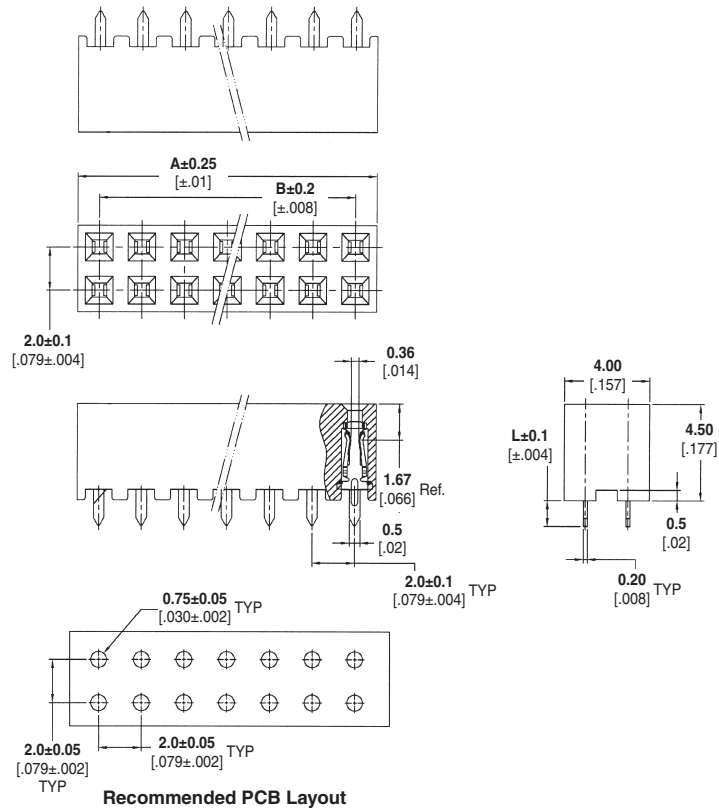

**Related Product Data**

**Mateable Headers** — pages 66-76, 78, 79

**Product Specification** 108-57197

**Packaging Method** — Tray

| No. of Positions | Dimensions   |              | Part Numbers                          |                                       |                                       |                                       |
|------------------|--------------|--------------|---------------------------------------|---------------------------------------|---------------------------------------|---------------------------------------|
|                  |              |              | Plating A                             |                                       | Plating B                             |                                       |
|                  | A            | B            | Dim. L<br>1.2+/-0.1<br>(.047+/- .004) | Dim. L<br>2.6+/-0.1<br>(.102+/- .004) | Dim. L<br>1.2+/-0.1<br>(.047+/- .004) | Dim. L<br>2.6+/-0.1<br>(.102+/- .004) |
| 4                | 4.0 [.157]   | 2.0 [.079]   | 1734506-1                             | 2-1734506-5                           | 5-1734506-1                           | 7-1734506-5                           |
| 6                | 6.0 [.236]   | 4.0 [.157]   | 1734506-2                             | 2-1734506-6                           | 5-1734506-2                           | 7-1734506-6                           |
| 8                | 8.0 [.315]   | 6.0 [.236]   | 1734506-3                             | 2-1734506-7                           | 5-1734506-3                           | 7-1734506-7                           |
| 10               | 10.0 [.394]  | 8.0 [.315]   | 1734506-4                             | 2-1734506-8                           | 5-1734506-4                           | 7-1734506-8                           |
| 12               | 12.0 [.472]  | 10.0 [.394]  | 1734506-5                             | 2-1734506-9                           | 5-1734506-5                           | 7-1734506-9                           |
| 14               | 14.0 [.551]  | 12.0 [.472]  | 1734506-6                             | 3-1734506-0                           | 5-1734506-6                           | 8-1734506-0                           |
| 16               | 16.0 [.630]  | 14.0 [.551]  | 1734506-7                             | 3-1734506-1                           | 5-1734506-7                           | 8-1734506-1                           |
| 18               | 18.0 [.709]  | 16.0 [.630]  | 1734506-8                             | 3-1734506-2                           | 5-1734506-8                           | 8-1734506-2                           |
| 20               | 20.0 [.787]  | 18.0 [.709]  | 1734506-9                             | 3-1734506-3                           | 5-1734506-9                           | 8-1734506-3                           |
| 22               | 22.0 [.866]  | 20.0 [.787]  | 1-1734506-0                           | 3-1734506-4                           | 6-1734506-0                           | 8-1734506-4                           |
| 24               | 24.0 [.945]  | 22.0 [.866]  | 1-1734506-1                           | 3-1734506-5                           | 6-1734506-1                           | 8-1734506-5                           |
| 26               | 26.0 [1.024] | 24.0 [.945]  | 1-1734506-2                           | 3-1734506-6                           | 6-1734506-2                           | 8-1734506-6                           |
| 28               | 28.0 [1.102] | 26.0 [1.024] | 1-1734506-3                           | 3-1734506-7                           | 6-1734506-3                           | 8-1734506-7                           |
| 30               | 30.0 [1.181] | 28.0 [1.102] | 1-1734506-4                           | 3-1734506-8                           | 6-1734506-4                           | 8-1734506-8                           |
| 32               | 32.0 [1.260] | 30.0 [1.181] | 1-1734506-5                           | 3-1734506-9                           | 6-1734506-5                           | 8-1734506-9                           |
| 34               | 34.0 [1.339] | 32.0 [1.260] | 1-1734506-6                           | 4-1734506-0                           | 6-1734506-6                           | 9-1734506-0                           |
| 36               | 36.0 [1.417] | 34.0 [1.339] | 1-1734506-7                           | 4-1734506-1                           | 6-1734506-7                           | 9-1734506-1                           |
| 38               | 38.0 [1.496] | 36.0 [1.417] | 1-1734506-8                           | 4-1734506-2                           | 6-1734506-8                           | 9-1734506-2                           |
| 40               | 40.0 [1.575] | 38.0 [1.496] | 1-1734506-9                           | 4-1734506-3                           | 6-1734506-9                           | 9-1734506-3                           |
| 42               | 42.0 [1.654] | 40.0 [1.575] | 2-1734506-0                           | 4-1734506-4                           | 7-1734506-0                           | 9-1734506-4                           |
| 44               | 44.0 [1.732] | 42.0 [1.654] | 2-1734506-1                           | 4-1734506-5                           | 7-1734506-1                           | 9-1734506-5                           |
| 46               | 46.0 [1.811] | 44.0 [1.732] | 2-1734506-2                           | 4-1734506-6                           | 7-1734506-2                           | 9-1734506-6                           |
| 48               | 48.0 [1.890] | 46.0 [1.811] | 2-1734506-3                           | 4-1734506-7                           | 7-1734506-3                           | 9-1734506-7                           |
| 50               | 50.0 [1.969] | 48.0 [1.890] | 2-1734506-4                           | 4-1734506-8                           | 7-1734506-4                           | 9-1734506-8                           |
| 40*              | 40.0 [1.575] | 38.0 [1.496] | —                                     | 4-1734506-9                           | —                                     | 9-1734506-9                           |

\*Keying position 6.

**Note:** All part numbers are RoHS compliant.

2.0 Mount Type w/PickUp

4

**2mm Receptacle, Double Row, Surface Mount, Right-Angle Mount**

**Receptacle, Surface Mount, Right-Angle**

**Material and Finish**

**Housing** — Black Thermoplastic, UL 94V-0 Rated

**Contact** — Phosphor Bronze

**Contact Finish** — 0.00020 [.000008]

Min. Gold Plated on Contact Area, 0.00229 [.000090] Min. Tin Plated on Solder Tail, 0.00127 [.000050] Min. Nickel Underplated Over All

**Related Product Data**

**Mateable Headers** — pages 66-73

**Product Specification** 108-57197

**Packaging Method** — Tape and reel

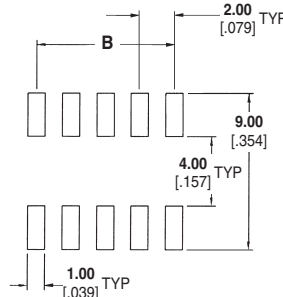
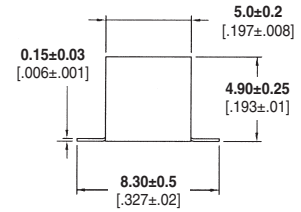
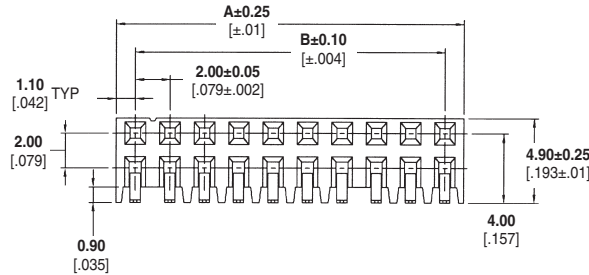
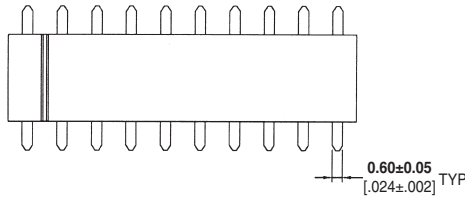

**Recommended PCB Layout**

| Position | Dimensions    |              | Part Numbers |
|----------|---------------|--------------|--------------|
|          | A             | B            |              |
| 6        | 6.20 [.244]   | 4.0 [.157]   | 1734606-6    |
| 8        | 8.20 [.323]   | 6.0 [.236]   | 1734606-8    |
| 10       | 10.20 [.402]  | 8.0 [.315]   | 1-1734606-0  |
| 12       | 12.20 [.480]  | 10.0 [.394]  | 1-1734606-2  |
| 14       | 14.20 [.559]  | 12.0 [.472]  | 1-1734606-4  |
| 16       | 16.20 [.638]  | 14.0 [.551]  | 1-1734606-6  |
| 18       | 18.20 [.717]  | 16.0 [.630]  | 1-1734606-8  |
| 20       | 20.20 [.795]  | 18.0 [.709]  | 2-1734606-0  |
| 22       | 22.20 [.874]  | 20.0 [.787]  | 2-1734606-2  |
| 24       | 24.20 [.953]  | 22.0 [.866]  | 2-1734606-4  |
| 26       | 26.20 [1.031] | 24.0 [.945]  | 2-1734606-6  |
| 28       | 28.20 [1.110] | 26.0 [1.024] | 2-1734606-8  |
| 30       | 30.20 [1.189] | 28.0 [1.102] | 3-1734606-0  |
| 32       | 32.20 [1.268] | 30.0 [1.181] | 3-1734606-2  |
| 34       | 34.20 [1.346] | 32.0 [1.260] | 3-1734606-4  |
| 36       | 36.20 [1.425] | 34.0 [1.339] | 3-1734606-6  |
| 38       | 38.20 [1.504] | 36.0 [1.417] | 3-1734606-8  |
| 40       | 40.20 [1.583] | 38.0 [1.496] | 4-1734606-0  |
| 42       | 42.20 [1.661] | 40.0 [1.575] | 4-1734606-2  |
| 44       | 44.20 [1.740] | 42.0 [1.654] | 4-1734606-4  |
| 46       | 46.20 [1.819] | 44.0 [1.732] | 4-1734606-6  |
| 48       | 48.20 [1.898] | 46.0 [1.811] | 4-1734606-8  |
| 50       | 50.20 [1.976] | 48.0 [1.890] | 5-1734606-0  |

**Note:** All part numbers are RoHS compliant.

## 2mm Receptacle, Double Row, Thru-Hole, Right-Angle Mount

### Receptacle, Thru-Hole, Right-Angle

#### Material and Finish

**Housing** — Black Thermoplastic, UL 94V-0 Rated

**Contact** — Phosphor Bronze

**Contact Finish** — 0.00020 [.000008]

Min. Gold Plated on Contact Area, 0.00254 [.000100] Min. Tin Plated on Solder Tail, 0.00127 [.000050] Min. Nickel Underplated Over All

#### Related Product Data

**Mateable Headers** — pages 66-73

#### Product Specification

108-57197

**Packaging Method** — Tube

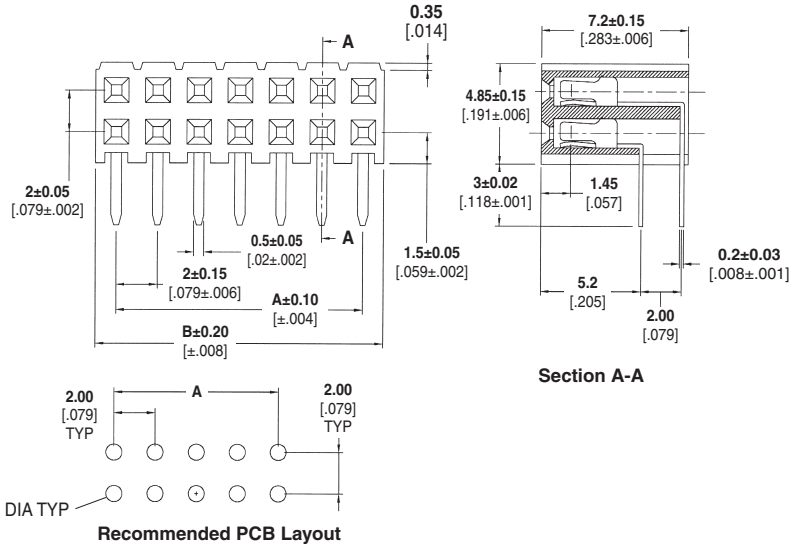

| Position | Dimensions   |               | Part Numbers |
|----------|--------------|---------------|--------------|
|          | A            | B             |              |
| 8        | 6.0 [.236]   | 8.50 [.335]   | 1734531-8    |
| 10       | 8.0 [.315]   | 10.50 [.413]  | 1-1734531-0  |
| 12       | 10.0 [.394]  | 12.50 [.492]  | 1-1734531-2  |
| 14       | 12.0 [.472]  | 14.50 [.571]  | 1-1734531-4  |
| 16       | 14.0 [.551]  | 16.50 [.650]  | 1-1734531-6  |
| 18       | 16.0 [.630]  | 18.50 [.728]  | 1-1734531-8  |
| 20       | 18.0 [.709]  | 20.50 [.807]  | 2-1734531-0  |
| 22       | 20.0 [.787]  | 22.50 [.886]  | 2-1734531-2  |
| 24       | 22.0 [.866]  | 24.50 [.965]  | 2-1734531-4  |
| 26       | 24.0 [.945]  | 26.50 [1.043] | 2-1734531-6  |
| 28       | 26.0 [1.024] | 28.50 [1.122] | 2-1734531-8  |
| 30       | 28.0 [1.102] | 30.50 [1.201] | 3-1734531-0  |
| 32       | 30.0 [1.181] | 32.50 [1.280] | 3-1734531-2  |
| 34       | 32.0 [1.260] | 34.50 [1.358] | 3-1734531-4  |
| 36       | 34.0 [1.339] | 36.50 [1.437] | 3-1734531-6  |
| 38       | 36.0 [1.417] | 38.50 [1.516] | 3-1734531-8  |
| 40       | 38.0 [1.496] | 40.50 [1.594] | 4-1734531-0  |
| 42       | 40.0 [1.575] | 42.50 [1.673] | 4-1734531-2  |
| 44       | 42.0 [1.654] | 44.50 [1.752] | 4-1734531-4  |
| 46       | 44.0 [1.732] | 46.50 [1.831] | 4-1734531-6  |
| 48       | 46.0 [1.811] | 48.50 [1.909] | 4-1734531-8  |
| 50       | 48.0 [1.890] | 50.50 [1.988] | 5-1734531-0  |
| 52       | 50.0 [1.969] | 52.50 [2.067] | 5-1734531-2  |
| 54       | 52.0 [2.047] | 54.50 [2.146] | 5-1734531-4  |
| 56       | 54.0 [2.123] | 56.50 [2.224] | 5-1734531-6  |
| 58       | 56.0 [2.205] | 58.50 [2.303] | 5-1734531-8  |
| 60       | 58.0 [2.283] | 60.50 [2.381] | 6-1734531-0  |
| 62       | 60.0 [2.362] | 62.50 [2.461] | 6-1734531-2  |
| 64       | 62.0 [2.441] | 64.50 [2.539] | 6-1734531-4  |
| 66       | 64.0 [2.520] | 66.50 [2.618] | 6-1734531-6  |
| 68       | 66.0 [2.598] | 68.50 [2.697] | 6-1734531-8  |
| 70       | 68.0 [2.677] | 70.50 [2.776] | 7-1734531-0  |
| 72       | 70.0 [2.756] | 72.50 [2.854] | 7-1734531-2  |
| 74       | 72.0 [2.834] | 74.50 [2.933] | 7-1734531-4  |
| 76       | 74.0 [2.913] | 76.50 [3.012] | 7-1734531-6  |
| 78       | 76.0 [2.992] | 78.50 [3.091] | 7-1734531-8  |
| 80       | 78.0 [3.071] | 80.50 [3.169] | 8-1734531-0  |

**Note:** All part numbers are RoHS compliant.

**2mm Receptacle, Double Row, Surface Mount, Vertical Mount**

**Receptacle, Top Entry, Surface Mount**

**Material and Finish**

**Housing**—Black Thermoplastic, UL 94V-0 Rated  
**Contact**—Copper Alloy, plated 0.00076 [0.00030] Min. Gold Plated on Contact Area, 0.00254 [0.00100] Tin Plated on Solder Tail, Underplated 0.00127 [0.00050] Nickel  
**Cap**—Thermoplastic

**Related Product Data**

**Mateable Headers**—pages 66-75, 78, 79

**Product Specification**  
108-57227

**Packaging Method**—Tape and reel

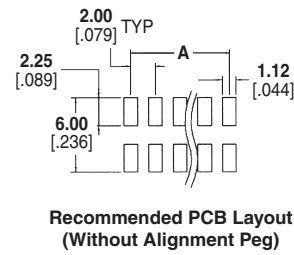
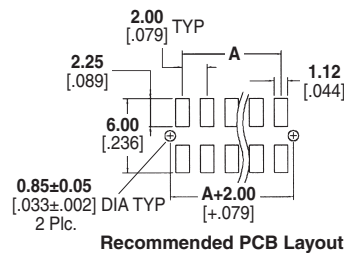
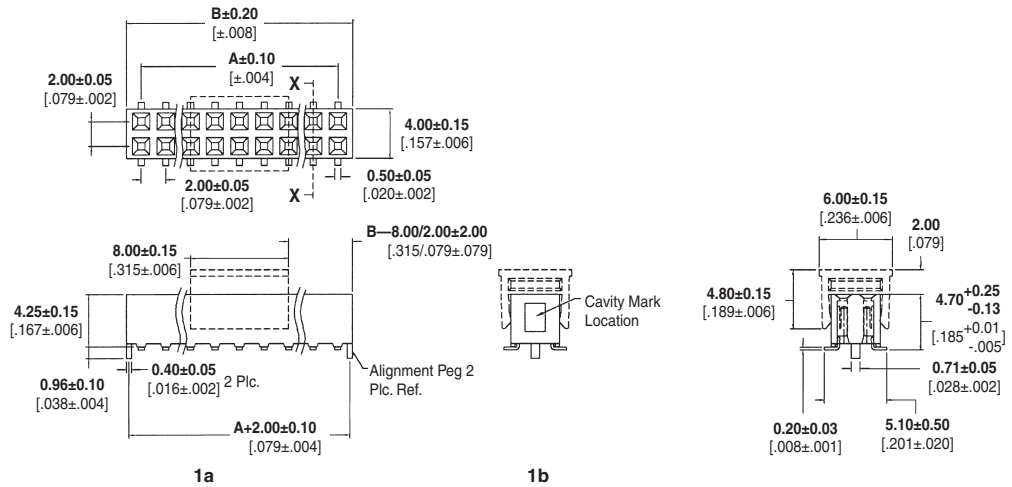

| Position | Dimensions   |               | 245C Reflow Part Numbers |                       | 265C Reflow Part Numbers |                       |
|----------|--------------|---------------|--------------------------|-----------------------|--------------------------|-----------------------|
|          | A            | B             | with Alignment Peg*      | without Alignment Peg | with Alignment Peg*      | without Alignment Peg |
| 8        | 6.0 [.236]   | 8.40 [.331]   | 1734516-8                | 5-1734516-8           | 2041069-8                | 5-2041069-8           |
| 10       | 8.0 [.315]   | 10.40 [.409]  | 1-1734516-0              | 6-1734516-0           | 1-2041069-0              | 6-2041069-0           |
| 12       | 10.0 [.394]  | 12.40 [.488]  | 1-1734516-2              | 6-1734516-2           | 1-2041069-2              | 6-2041069-2           |
| 14       | 12.0 [.472]  | 14.40 [.567]  | 1-1734516-4              | 6-1734516-4           | 1-2041069-4              | 6-2041069-4           |
| 16       | 14.0 [.551]  | 16.40 [.646]  | 1-1734516-6              | 6-1734516-6           | 1-2041069-6              | 6-2041069-6           |
| 18       | 16.0 [.630]  | 18.40 [.724]  | 1-1734516-8              | 6-1734516-8           | 1-2041069-8              | 6-2041069-8           |
| 20       | 18.0 [.709]  | 20.40 [.803]  | 2-1734516-0              | 7-1734516-0           | 2-2041069-0              | 7-2041069-0           |
| 22       | 20.0 [.787]  | 22.40 [.881]  | 2-1734516-2              | 7-1734516-2           | 2-2041069-2              | 7-2041069-2           |
| 24       | 22.0 [.866]  | 24.40 [.961]  | 2-1734516-4              | 7-1734516-4           | 2-2041069-4              | 7-2041069-4           |
| 26       | 24.0 [.945]  | 26.40 [1.039] | 2-1734516-6              | 7-1734516-6           | 2-2041069-6              | 7-2041069-6           |
| 28       | 26.0 [1.024] | 28.40 [1.118] | 2-1734516-8              | 7-1734516-8           | 2-2041069-8              | 7-2041069-8           |
| 30       | 28.0 [1.102] | 30.40 [1.197] | 3-1734516-0              | 8-1734516-0           | 3-2041069-0              | 8-2041069-0           |
| 32       | 30.0 [1.181] | 32.40 [1.276] | 3-1734516-2              | 8-1734516-2           | 3-2041069-2              | 8-2041069-2           |
| 34       | 32.0 [1.260] | 34.40 [1.354] | 3-1734516-4              | 8-1734516-4           | 3-2041069-4              | 8-2041069-4           |
| 36       | 34.0 [1.339] | 36.40 [1.433] | 3-1734516-6              | 8-1734516-6           | 3-2041069-6              | 8-2041069-6           |
| 38       | 36.0 [1.417] | 38.40 [1.512] | 3-1734516-8              | 8-1734516-8           | 3-2041069-8              | 8-2041069-7           |
| 40       | 38.0 [1.496] | 40.40 [1.591] | 4-1734516-0              | 9-1734516-0           | 4-2041069-0              | 9-2041069-0           |

\*See views 1a and 1b

**Note:** All part numbers are RoHS compliant.

2mm Receptacle  
**4**