

AMPMODU .025 [0.64] Square Interconnection System (Continued)

AMPMODU Headers and Receptacles, .100 [2.54] Centerline



Legend:

- SR Single Row
- DR Double Row
- VT Vertical
- RA Right Angle
- RET Retention Feature
- AP ACTION PIN
- BE Bottom Entry
- 3/4 3-Sided-Shrouded Header
- BA Breakaway
- TR Triple Row
- SMT Surface Mount
- HORZ Horizontal
- DE Dual Entry

For drawings, technical data or samples, contact your Tyco Electronics sales engineer or call the Tyco Electronics Product Information Center: 1-800-522-6752

Note: All part numbers are RoHS compliant.

AMPMODU .025 [0.64] Square Interconnection System

The AMPMODU interconnection system provides interconnections with a unique modular concept, utilizing precision formed receptacle contacts and mating posts.

Mating of the post and receptacle contacts of this system is very tolerant. This is made possible by a post with a burr-free lead-in and a receptacle contact featuring double cantilever beams and anti-overstress stops.

AMPMODU receptacle contacts and posts categorically fall into three general classifications of products, which include: board mounted posts and receptacle assemblies, post headers and wire-applied contact housings for crimp snap-in pin and receptacle contacts.

Board mounted receptacle assemblies are available in various geometries, offering packaging interconnections that include perpendicular, parallel and stacking capabilities.

Crimp snap-in pins for 26-22 AWG [0.12-0.4 mm²] wire and crimp snap-in receptacles for 32-20 AWG [0.03-0.6 mm²] wire provide excellent discrete wire terminations. Housings for these contacts provide ease of handling terminations in high density applications.

Machine applied terminations, through matched application equipment, are geared for virtually any production volume requirement, for the lowest possible applied cost.

AMPMODU mating posts are supplied typically as headers. They are available in various populations to meet the interconnection and packaging requirements of most systems. However, in instances where packaging configurations do not lend themselves to the economies of headers, Tyco Electronics can provide application equipment for the discrete location of individual posts.

Looking at the electronic industry's standard "levels of packaging," the AMPMODU .025 [0.64] square interconnection system is primarily used in levels three and four.

In level three it is used as a connection between two or more printed circuits. A mother/daughter board connection is typical. In

level four it is used as a connection between two subassemblies, such as a power supply and an associated subassembly.

It is also important to note this product can serve as an interconnection in more than one level, depending on the application.

The .025 [0.64] square interconnection system offers the most complete line of post/receptacle packaging products available today. This system, rated at 3 amperes per contact, has been used by almost every industry and marketplace over the last decade and is one of the oldest, most versatile and reliable interconnection systems employing .025 [0.64] square packaging technology.

Terms Explained

Receptacle Contacts

The AMPMODU receptacle cross-section is primarily rectangular, with rounded corners. Two integral cantilever beams contact the mating square or round male posts. Deflection of these spring members is limited by anti-overstress stops, and excessive permanent deformation is prevented. This feature allows a wide range for tolerance of misalignment of mating contacts.

The configuration of the receptacle completely encloses the spring members preventing damage during handling and assembly and makes the system compatible with automatic application techniques.

Note: Application of a contact lubricant is part of the manufacturing process of all AMPMODU tin-plated crimp products. However, it is not part of the manufacturing process of products that customers will solder, then clean. For these products, Tyco Electronics recommends that customers use contact lubricant. See the Tyco Electronics web page for further information.

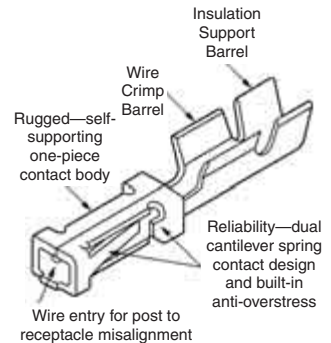

Offers standard, intermediate and high pressure contact forces



Receptacle-Closed Entry Housing Design

The closed entry housing style better eliminates the chance of a mating post stubbing on the edges of the receptacle contact.

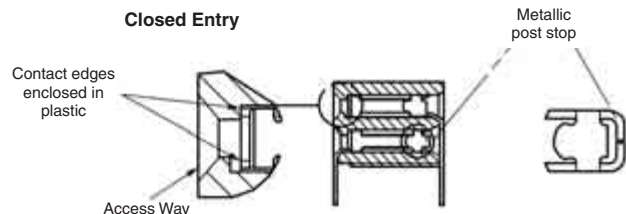

Wire-to-Board, .100 [2.54] Centerline Products

Wire Sizes

Wire Size		Product Family
AWG	[mm ²]	
20	0.5-0.6	Locking Clip, Mod. IV, IV.v, V, MT, Short Point
22-30	0.3-0.05	Locking Clip, Mod. IV, IV.v, V, MTE, MT, Short Point
32	0.03	Mod. IV, IV.v, V, Short Point

Contact Platings

Platings	Product Family
.000015 [0.00038] Gold	Mod. IV, IV.v, V, MTE, MT, Short Point
.000030 [0.00076] Gold	Locking Clip, Mod. IV, IV.v, V, MTE, MT, Short Point
.000050 [0.00127] Gold	Locking Clip, Mod. IV, IV.v, V, MT
Tin	Locking Clip, Mod. IV, IV.v, V, MTE, MT, Short Point

Mating Post Lengths

Post Lengths	Product Family
.210-.283 [5.33-7.19]	Mod. IV (.600 [15.24] Profile Height)
.205-.283 [5.21-7.19]	Mod. IV.v (.600 [15.24] Profile Height)
.185-.283 [4.70-7.19]	Mod. V (.600 [15.24] Profile Height)
.256-.323 [6.50-8.20]	Mod. IV (.645 [16.38] Profile Height)
.251-.323 [6.38-8.20]	Mod. IV.v (.645 [16.38] Profile Height)
.231-.323 [5.87-8.20]	Mod. V (.645 [16.38] Profile Height)
.222-.273 [5.64-6.93]	MT Assembly with Standard Pressure Contacts
.200-.273 [5.08-6.93]	MT Assembly with High Pressure Contacts
.200-.250 [5.08-6.35]	MTE Assembly
.169-.259 [4.29-6.58]	Short Point Connector Assembly
.273-.350 [6.93-8.89]	Locking Clip (Connector Assembly)
.200-.277 [5.08-7.04]	Locking Clip (Single Contact)

Application Tooling

Application Tooling Description	Product Family					
	Mod. IV, IV.v, V	MT	Locking Clip	MTE	Short Point	Level V
Manual Hand Tools (Wire Crimp)	•		•	•	•	
Manual Hand Tools (IDC)		•		•		•
AMP-O-MATIC Stripper/Crimper Machines with Applicator	•		•		•	
CHAMPOMATOR Model 2.5 Machine		•				•
CHAMPOMATOR Model 3A Machine		•				
AMP-O-LECTRIC Machines with Applicator	•		•		•	
Pneumatic Hand Tools	•	•	•	•	•	•
IDC Electric Power Unit				•		
Tube-Fed Ribbon Cable Machine				•		
AMPOMATOR CLS Machines	•		•		•	
Discrete Wire Machine		•				•
Manual Arbor Tool		•				•
Pneumatic Arbor Tool		•				•

Board-to-Board Solutions Guide, .100 [2.54] Centerline Products

Problem or Concern	Tyco Electronics' Potential Solution	Single-Row Vertical Headers and Receptacles (Page Ref.)	Single-Row Right-Angle Headers, Horizontal Receptacles (Page Ref.)	Double-Row Vertical Headers and Receptacles (Page Ref.)	Double-Row Right-Angle Headers, Horizontal Receptacles (Page Ref.)	
Headers Float Off Board Soldering Operation	HEADERS Retention Feature: Unshrouded Shrouded	102 —	103 —	198 104, 199	199 105, 200	
Header Contacts Damaged During Manufacturing Operation or In-Field Use	Shrouded HEADERS : Standard Profile	115	116	117-121	122-128	
Board/Backplane Requires High Temperature Surface-Mount Compatibility	Press-Fit ACTION PIN POST					
	HEADERS : Unshrouded Shrouded	146 —	— —	147 148, 149, 199	— —	
	Machine Applied Posts	163, 164				
	Surface-Mount Compatible Thru-Hole: HEADERS : Unshrouded Shrouded (Low Profile) RECEPTACLES	102* — — —	103* — — —	104* 130*, 137* 196*	105* 138* 195*	
Application Requires Board Guidance, Polarization and/or Blind-Mate Capability	Surface-Mount: HEADERS RECEPTACLES	109* 187, 188	— 172	110 189-192	— 173	
	Two-Piece Family: w/Guide Posts: HEADERS RECEPTACLES	— —	— —	198, 199 196*	200 195*	
Reduction in Parallel Board-to-Board Stack Height Necessary (Refer to Parallel Stack Guide on Page 62.)	Mod IV Low Profile RECEPTACLES : TOP ENTRY : Thru-Hole Surface-Mount BOTTOM ENTRY : Thru-Hole Surface-Mount DUAL ENTRY : Thru-Hole Surface Mount	178 — — 177 — 181 187, 188	— — — — — — —	179, 180* — — — — 182-184 189-192	— — — — — — —	
	Soldering Problems with Thru-Hole Bottom Entry Receptacles (Must Mask Post Holes in Board During Soldering Operation)	RECEPTACLES : Bottom Entry Outrigger (Separate Holes for Receptacle Leads and Mating Leads)	181	—	182	—
	Application Requires Connectors to be End-to-End Stackable on .100 [2.54] Grid	End-to-End Stackable: HEADERS (Unshrouded): Thru-Hole Thru-Hole* Surface-Mount RECEPTACLES : Thru-Hole Surface Mount	93, 102 102* 109* 175, 177, 178, 181 188	94, 95, 103* 103* — 169* 172	96, 97, 104* 104* 110* 176, 179, 180*, 182*, 183, 184 191, 192	98, 99, 105 108* — 170 173

*High temperature compatible version, refer to page ref. listed.

Wire-to-Board Solutions Guide, .100 [2.54] Centerline Products

Customer Requirement	Tyco Electronics' Potential Solution	Catalog Page(s)
Application Requires Guidance, Polarization	Mod IV Polarized Housing	220
	MTE Latched Receptacle and Header	230, 231, 244-250
	MT with Polarizing Covers	256-258
Wire-to-Wire Application	Short Point Polarized Housing	224
	Mod IV Receptacle Contacts and Pins	211-213
Wire-to-Wire Application (Latched)	MTE Latched Receptacle and Shrouded Pin Assembly	230, 231, 236, 237
Wire-to-Wire Application (Through Panel)	MTE Panel Mount	242
High Vibration and Shock Applications	Locking Clip Contacts and Housings	207-209
Printed Circuit Board Polarization	MTE Header with PC Board Orientation Peg	248, 249
Board Requires Surface Mount Capability	MTE Surface Mount Headers	251, 252
	MTE High Temperature Compatible Headers	249, 250
Need to mate to AMP-LATCH Eject Headers	Mod IV Ejection Housing	220
Need to Minimize Strain to Cable	MT with Eject Covers	256-259
	Mod IV Housing with Strain Relief	218, 219
Application Requires Self-Retaining Contacts	Locking Clip Contacts	207, 298
Header Secured to Board During/Prior to Soldering	MTE Headers with Post Retention or Holddowns	244-250
Mate to Unshrouded Header with Retention Requirements	Mod IV plain Housing with Mod V Contacts	213, 214, 216
	MTE with High Pressure Contacts	234, 235
Multiple Cables to be Common to One Header	MTE Coupling Shroud, Double- or Single-Row	240, 241
Right-Angle Cable Dress	MT with Hermaphroditic Covers	229, 256, 257, 259
Application Requires Crimp Contacts and MTE Housings	Short Point Contacts	222
Housings and End-to-End and Side-to-Side Stackable	Short Point Double-Row Housing, MTE Plain Housing	223, 228, 229
Connector Must Mate to Post Lengths of .169 [4.29] Min.	Short Point Contacts	222

Mating Post Selection Guide

The following selection guide is provided to help in choosing a mating product after a receptacle, header or post has been selected.

In some instances references are given on the catalog page to specific mating connectors. In other instances the reader is referred here to the selection guide for mating product recommendations.

If your application requirement is not answered here, consult Tyco Electronics for further recommendations.

Posts Without Shoulders

For drawn wire products (ie, AMPMODU Breakaway and Low Profile Headers) and for products having the shoulder of the post below the housing or pc board surface (ie, AMPMODU MTE and Single Row Shrouded Headers) the effective mating length starts at the housing or pc board surface.

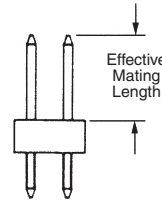

Posts With Shoulders

For product having the shoulder of the post extending above the housing or pc board surface (ie, Standard AMPMODU Shrouded and Unshrouded Headers) the effective mating length starts at the top of the shoulder.

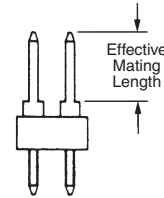

Receptacle Type	Recommended Effective Mating Posts Lengths	
	Minimum	Maximum
AMPMODU Mod II Horizontal Board Mount Receptacle, Single and Double Row, Short Point-of-Contact—pages 169, 170, 172, 173	.230 [5.84]	.280 [7.11]
AMPMODU Mod II Vertical Board Mount Receptacle, Single Row, Standard Profile, Top Entry—page 175	.183 [4.65]	.330 [8.38]
AMPMODU Mod II Vertical Board Mount Receptacle, Standard Profile, Double Row, Top Entry, 100 x .100 mt.—page 176	.183 [4.65]	.330 [8.38]
AMPMODU Mod IV Vertical Board Mount Receptacle, Low Profile, Single Row, Top Entry, Single Tine—page 178	.183 [4.65]	.255 [6.48]
AMPMODU Mod IV Vertical Board Mount Receptacle, Low Profile, Single Row, Bottom Entry—page 177	.280 [7.11]	*
AMPMODU Mod IV Vertical Board Mount Receptacle, Low Profile, Double Row, Top Entry—pages 179, 180	.183 [4.65]	.255 [6.48]
AMPMODU Surface-Mount Receptacle, Vertical Board Mount, Single Row, Dual Entry—page 187, 188	Top Entry .183 [4.65] Bottom Entry .204 [5.18]	* *
AMPMODU Mod IV Vertical Board Mount Receptacle, Low Profile, Double Row, Dual Entry—page 182	Top Entry .183 [4.65] Bottom Entry .204 [5.18]	* *
AMPMODU Surface-Mount Receptacle, Vertical Board Mount, Double Row, Dual Entry—page 189-192	Top Entry .183 [4.65] Bottom Entry .204 [5.18]	* *
AMPMODU .600 [15.24] Mod IV Housing with Standard Pressure Contacts—pages 211-220	.210 [5.33]	.283 [7.19]
AMPMODU .600 [15.24] Mod IV Housing with Intermediate Pressure Contacts—pages 211-220	.205 [5.21]	.283 [7.19]
AMPMODU .600 [15.24] Mod IV Housing with High Pressure Contacts—pages 211-220	.185 [4.70]	.283 [7.19]
AMPMODU Mod IV Vertical Board Mount Receptacle, Low Profile, Single Row, Dual Entry—page 181	Top Entry .183 [4.65] Bottom Entry .204 [5.18]	* *

Receptacle Type	Recommended Effective Mating Posts Lengths		
	Minimum	Maximum	
Short Point Housing with Contacts—pages 222-224	.169 [4.29]	.259 [6.58]	
AMPMODU MTE Unloaded Housing with Short Point Contacts—pages 222, 229, 231, 233	.169 [4.29]	.259 [6.58]	
AMPMODU MTE IDC Assemblies	.200 [5.08]	.250 [6.35]	
AMPMODU MT IDC Assembly with Standard Pressure Contacts—page 256	.222 [5.64]	.273 [6.93]	
AMPMODU MT IDC Assembly with High Pressure Contacts—page 257	.200 [5.08]	.273 [6.93]	
Locking Clip Housing with Contacts—pages 207-209	.273 [6.93]	.350 [8.89]	
Locking Clip Contact without Housing—page 207	.200 [5.08]	.277 [7.04]	
Flexible Flat Conductor Cable Receptacle with Round Wire Crimp High Pressure Contact—Catalog 82007	Single Row	.267 [6.78]	.323 [8.20]
	Double Row	.282 [7.16]	.323 [8.20]
Flexible Flat Conductor Cable Receptacle with Multiple Wire Crimp High Pressure Contact—Catalog 82007	Single Row	.210 [5.33]	.323 [8.20]
	Double Row	.225 [5.72]	.323 [8.20]
Flexible Flat Conductor Cable Receptacle with Round Wire Crimp Standard Pressure Contact—Catalog 82007	Single Row	.267 [6.78]	.323 [8.20]
	Double Row	.282 [7.16]	.323 [8.20]
Flexible Flat Conductor Cable Receptacle with Multiple Crimp Standard Pressure Contact—Catalog 82007	Single Row	.220 [5.59]	.323 [8.20]
	Double Row	.235 [5.97]	.323 [8.20]

*Maximum post length is determined by customer's application; (i.e., available space beyond rear of horizontal receptacle assembly, or above bottom entry vertical receptacle assembly or below vertical receptacle assemblies used in pass through applications).

Parallel Stacking Guide for Board-to-Board Applications

See Figure Below	Dimension Between PC Boards	Product Family Headers (See Note 1.)	Single-Row (Page Ref.)	Double-Row (Page Ref.)	Product Family Receptacles	Single-Row (Page Ref.)	Double-Row (Page Ref.)
	.060 [1.52]	Bandolier Posts	163	NA	Dual Entry, Mod IV	177, 181, 187, 188	182-184, 189-192
1	.090 [2.29]	Breakaway** (Unshrouded)	102**	104**	Dual Entry, Mod IV	177, 181, 187, 188	182-184, 189-192
	.153 [3.89]	Surface Mount** Breakaway (Unshrouded)	NA	110	Dual Entry, Mod IV	177, 181, 187, 188	182-184, 189-192
	.265 [6.73]	Bandolier Posts	163	137**	Top Entry, Mod IV	178, 181, 187, 188	179, 180, 182-184, 189-192
2	.355 [9.02]	Breakaway** (Unshrouded)	102**	104**	Top Entry, Mod IV	178, 181, 187, 188	179, 180, 182-184, 189-192
	.385 [9.78]	Low Profile Shrouded	NA	135, 137**	Top Entry, Mod IV	NA	179, 180
3	.418 [10.6]	Surface Mount** Breakaway (Unshrouded)	109	110	Surface Mount**, Mod IV, Top Entry	187, 188	189-192
2*	.430 [10.92]	Breakaway** (Unshrouded)	102**	104**	Top Entry, Mod II	175	176
4*	.440 [11.18]	Shrouded, Mod II	115, 116	117, 119	Top Entry, Mod II or Mod IV	175, 178	176, 179, 180
	.528 [13.41]	Stacking Shroud (See Note 2.)	NA	156 (Hood)	Inner Board Receptacle (See Note 2.)	NA	157
	.547 [13.89]	Stacking Shroud (See Note 2.)	NA	160	Outer Board Receptacle (See Note 2.)	NA	158
4	.550 [13.97]	Two-Piece Header Connector System	NA	198, 199	Two-Piece Receptacle** Connector System	NA	196**
	.748 [19.00]	Stacking Shroud (See Note 2.)	NA	156 (Hood)	Inner Board Receptacle (See Note 2.)	NA	157
	.768 [19.51]	Stacking Shroud (See Note 2.)	NA	161	Outer Board Receptacle (See Note 2.)	NA	158
	Various	Stacking Unshrouded	112	113	Mod II/IV Receptacles, Top/Bottom Entry	Various	Various

**High temperature version available, see page ref. listed.

Notes: 1. Headers listed are standard thru-hole versions. Many headers are available with retention feature and ACTION PIN posts. See product specification pages in individual sections for option availability.

2. These headers and receptacles are Related Board-to-Board products. They are not part of the AMPMODU .025 [0.64] Square Product Family.

Board-to-Board Stacking Heights (By Receptacle/Header Combination)

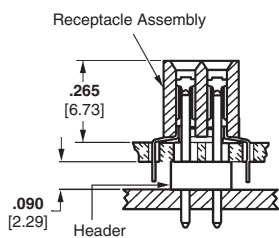

Figure 1
Double-Row, Mod IV, Bottom Entry, Breakaway Header

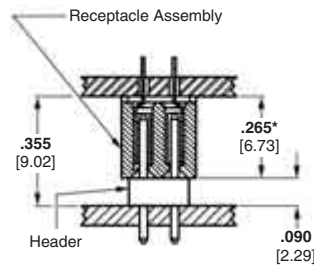

Figure 2
Double-Row, Mod IV, Top Entry, Breakaway Header
*Mod II Receptacle Height is .340 [8.64] for a total stack height of .430 [10.92]

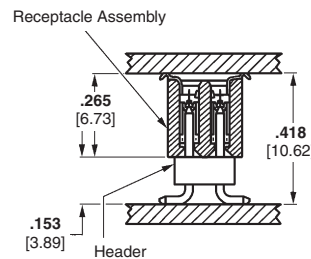

Figure 3
Double-Row, Mod IV, Surface-Mount, Top Entry, Receptacle and Surface-Mount Breakaway Header

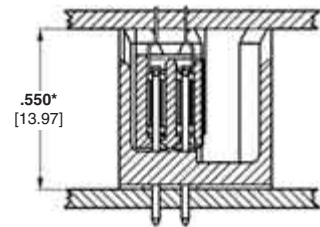
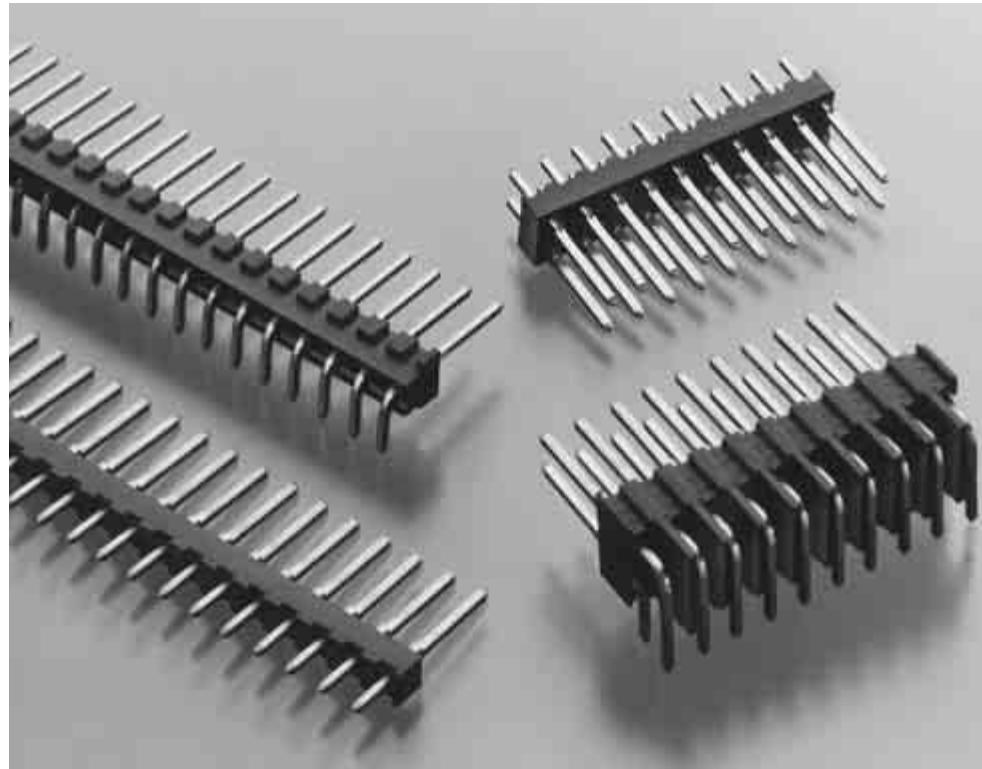

Figure 4
Double-Row, Two-Piece Receptacle and Two-Piece Shrouded Header
*Mod II Shrouded Header Height is .440 [11.18] for a total stack height of .440 [11.18]

Standard Headers—Unshrouded

Product Facts

- Variety of popular sizes available
- Substantial time/labor savings—install all posts at one time
- Vertical and right-angle versions available in single- and double-row configurations
- Triple-row version available in vertical configuration with .230 [5.84] mating length
- Copper alloy posts
- Choice of select gold or tin plated posts
- Mating length for single and double row is .318 [8.08] (.278 [7.06] effective mating length—see page 90)
- Flame retardant, black thermoplastic housings; 94V-0 rated
- Recognized under the Component Program of Underwriters Laboratories Inc., File No. E28476
- Certified by Canadian Standards Association, File No. LR 7189



Performance Characteristics

Electrical

Insulation Resistance — 5,000 megohms minimum initial

Dielectric Withstanding Voltage — 750 V rms at sea level

Environmental

Operating Temperature — -65°C to +105°C (black thermoplastic housings)

Current — 3 amperes maximum per contact (dependent upon mating connector)

Standard Headers—Unshrouded, Single Row, .100 [2.54] Centerline

.025 [0.64] Square Straight Post



Material and Finish

Housing — Black thermoplastic, 94V-0 rated

Posts — Copper alloy, plated as follows:

Plating A — Selectively plated .000030 [0.00076] gold on contact area, with gold flash over .000050 [0.00127] nickel on entire post

Plating B — Selectively plated .000015 [0.00038] gold on contact area, with gold flash over .000050 [0.00127] nickel on entire post

Tin/Nickel — Plating option available; minimum order quantities may apply. Consult Tyco Electronics.

Recommended PC Board Hole Layout (for .055 [1.40] min. thick PC board)
*±.003 [±0.08] tolerances not to accumulate within one connector pattern.

Related Product Data

Mateable Connectors — Refer to the Mating Post Selection Guide — page 90

Technical Documents — page 276

See mating connector for applicable product and application specifications.

No. of Pos.	Dimensions		Post Plating/Part Nos.	
	A	B	Plating A	Plating B
1	.084 [2.13]	—	87220-1	87224-1
2	.184 [4.67]	.100 [2.54]	87220-2	87224-2
3	.284 [7.21]	.200 [5.08]	87220-3	87224-3
4	.384 [9.75]	.300 [7.62]	87220-4	87224-4
5	.484 [12.29]	.400 [10.16]	87220-5	87224-5
6	.584 [14.83]	.500 [12.70]	87220-6	87224-6
7	.684 [17.37]	.600 [15.24]	87220-7	87224-7
8	.784 [19.91]	.700 [17.78]	87220-8	87224-8
9	.884 [22.45]	.800 [20.32]	87220-9	87224-9
10	.984 [24.99]	.900 [22.86]	1-87220-0	1-87224-0
11	1.084 [27.53]	1.000 [25.40]	1-87220-1	1-87224-1
12	1.184 [30.07]	1.100 [27.94]	1-87220-2	1-87224-2
13	1.284 [32.61]	1.200 [30.48]	1-87220-3	1-87224-3
14	1.384 [35.15]	1.300 [33.02]	1-87220-4	1-87224-4
15	1.484 [37.69]	1.400 [35.56]	1-87220-5	1-87224-5
16	1.584 [40.23]	1.500 [38.10]	1-87220-6	1-87224-6
17	1.684 [42.77]	1.600 [40.64]	1-87220-7	1-87224-7
18	1.784 [45.31]	1.700 [43.18]	1-87220-8	1-87224-8
19	1.884 [47.85]	1.800 [45.72]	1-87220-9	1-87224-9
20	1.984 [50.39]	1.900 [48.26]	2-87220-0	2-87224-0
21	2.084 [52.93]	2.000 [50.80]	2-87220-1	2-87224-1
22	2.184 [55.47]	2.100 [53.34]	2-87220-2	2-87224-2
23	2.284 [58.01]	2.200 [55.88]	2-87220-3	2-87224-3
24	2.384 [60.55]	2.300 [58.42]	2-87220-4	2-87224-4
25	2.484 [63.09]	2.400 [60.96]	2-87220-5	2-87224-5
26	2.584 [65.63]	2.500 [63.50]	2-87220-6	2-87224-6
27	2.684 [68.17]	2.600 [66.04]	2-87220-7	2-87224-7
28	2.784 [70.71]	2.700 [68.58]	2-87220-8	2-87224-8
29	2.884 [73.25]	2.800 [71.12]	2-87220-9	2-87224-9
30	2.984 [75.79]	2.900 [73.66]	3-87220-0	3-87224-0
31	3.084 [78.33]	3.000 [76.20]	3-87220-1	3-87224-1
32	3.184 [80.87]	3.100 [78.74]	3-87220-2	3-87224-2
33	3.284 [83.41]	3.200 [81.28]	3-87220-3	3-87224-3
34	3.384 [85.95]	3.300 [83.82]	3-87220-4	3-87224-4
35	3.484 [88.49]	3.400 [86.36]	3-87220-5	3-87224-5
36	3.584 [91.03]	3.500 [88.90]	3-87220-6	3-87224-6
37	3.684 [93.57]	3.600 [91.44]	3-87220-7	3-87224-7
38	3.784 [96.11]	3.700 [93.98]	3-87220-8	3-87224-8
39	3.884 [98.65]	3.800 [96.52]	3-87220-9	3-87224-9
40	3.984 [101.19]	3.900 [99.06]	4-87220-0	4-87224-0

Note: All part numbers are RoHS compliant.

Standard Headers—Unshrouded, Single Row, .100 [2.54] Centerline (Continued)

.025 [0.64] Square Right-Angle Post

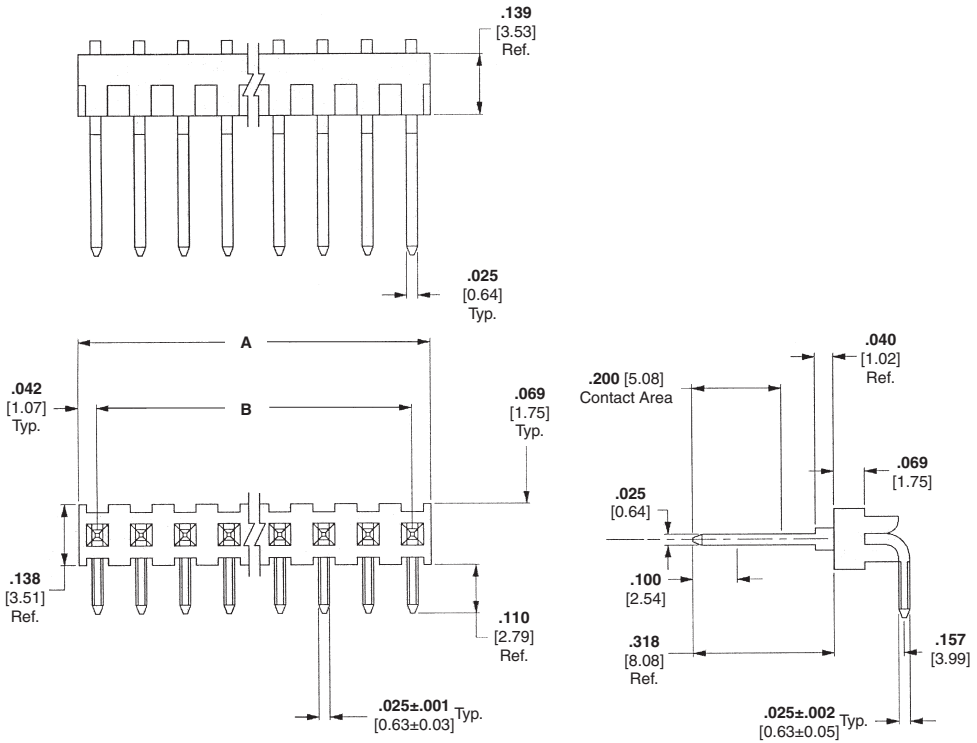

Material and Finish

Housing — Black thermoplastic, 94V-0 rated

Posts — Copper alloy, plated as follows:

Plating A — Selectively plated .000030 [0.00076] gold on contact area, with gold flash over .000050 [0.00127] nickel on entire post

Plating B — Selectively plated .000015 [0.00038] gold on contact area, with gold flash over .000050 [0.00127] nickel on entire post

Tin/Nickel — Plating option available; minimum order quantities may apply. Consult Tyco Electronics.

Related Product Data

Mateable Connectors — Refer to the Mating Post Selection Guide — page 90



Recommended PC Board Hole Layout
(for .055 [1.40] min. thick PC board)

*±.003 [±0.08] tolerances not to accumulate within one connector pattern.

Technical Documents — page 276

See mating connector for applicable product and application specifications.

No. of Pos.	Dimensions		Post Plating/Part Nos.	
	A	B	Plating A	Plating B
1	.084 [2.13]	—	87232-1	87233-1
2	.184 [4.67]	.100 [2.54]	87232-2	87233-2
3	.284 [7.21]	.200 [5.08]	87232-3	87233-3
4	.384 [9.75]	.300 [7.62]	87232-4	87233-4
5	.484 [12.29]	.400 [10.16]	87232-5	87233-5
6	.584 [14.83]	.500 [12.70]	87232-6	87233-6
7	.684 [17.37]	.600 [15.24]	87232-7	87233-7
8	.784 [19.91]	.700 [17.78]	87232-8	87233-8
9	.884 [22.45]	.800 [20.32]	87232-9	87233-9
10	.984 [24.99]	.900 [22.86]	1-87232-0	1-87233-0
11	1.084 [27.53]	1.000 [25.40]	1-87232-1	1-87233-1
12	1.184 [30.07]	1.100 [27.94]	1-87232-2	1-87233-2
13	1.284 [32.61]	1.200 [30.48]	1-87232-3	1-87233-3
14	1.384 [35.15]	1.300 [33.02]	1-87232-4	1-87233-4
15	1.484 [37.69]	1.400 [35.56]	1-87232-5	1-87233-5
16	1.584 [40.23]	1.500 [38.10]	1-87232-6	1-87233-6
17	1.684 [42.77]	1.600 [40.64]	1-87232-7	1-87233-7
18	1.784 [45.31]	1.700 [43.18]	1-87232-8	1-87233-8
19	1.884 [47.85]	1.800 [45.72]	1-87232-9	1-87233-9
20	1.984 [50.39]	1.900 [48.26]	2-87232-0	2-87233-0

Note: All part numbers are RoHS compliant.

Standard Headers—Unshrouded, Single Row, .100 [2.54] Centerline (Continued)

No. of Pos.	Dimensions		Post Plating/Part Nos.	
	A	B	Plating A	Plating B
21	2.084 [52.93]	2.000 [50.80]	2-87232-1	2-87233-1
22	2.184 [55.47]	2.100 [53.34]	2-87232-2	2-87233-2
23	2.284 [58.01]	2.200 [55.88]	2-87232-3	2-87233-3
24	2.384 [60.55]	2.300 [58.42]	2-87232-4	2-87233-4
25	2.484 [63.09]	2.400 [60.96]	2-87232-5	2-87233-5
26	2.584 [65.63]	2.500 [63.50]	2-87232-6	2-87233-6
27	2.684 [68.17]	2.600 [66.04]	2-87232-7	2-87233-7
28	2.784 [70.71]	2.700 [68.58]	2-87232-8	2-87233-8
29	2.884 [73.25]	2.800 [71.12]	2-87232-9	2-87233-9
30	2.984 [75.79]	2.900 [73.66]	3-87232-0	3-87233-0
31	3.084 [78.33]	3.000 [76.20]	3-87232-1	3-87233-1
32	3.184 [80.87]	3.100 [78.74]	3-87232-2	3-87233-2
33	3.284 [83.41]	3.200 [81.28]	3-87232-3	3-87233-3
34	3.385 [85.95]	3.300 [83.82]	3-87232-4	3-87233-4
35	3.484 [88.49]	3.400 [86.36]	3-87232-5	3-87233-5
36	3.584 [91.03]	3.500 [88.90]	3-87232-6	3-87233-6
37	3.684 [93.57]	3.600 [91.44]	3-87232-7	3-87233-7
38	3.784 [96.11]	3.700 [93.98]	3-87232-8	3-87233-8
39	3.884 [98.65]	3.800 [96.52]	3-87232-9	3-87233-9
40	3.984 [101.19]	3.900 [99.06]	4-87232-0	4-87233-0

Note: All part numbers are RoHS compliant.

Standard Headers—Unshrouded, Double-Row, .100 x .100 [2.54 x 2.54] Centerline

.025 [0.64] Square Straight Post



Material and Finish

Housing — Black thermoplastic, 94V-0 rated

Posts — Copper alloy, plated as follows:

Plating A — Selectively plated .000030 [0.00076] gold on contact area, with gold flash over .000050 [0.00127] nickel on entire post

Plating B — Selectively plated .000015 [0.00038] gold on contact area, with gold flash over .000050 [0.00127] nickel on entire post

Tin/Nickel — Plating option available; minimum order quantities may apply. Consult Tyco Electronics.



Recommended PC Board Hole Layout (for .055 [1.40] min. thick PC board)

*±.003 [±0.08] tolerances not to accumulate within one connector pattern.

Related Product Data

Mateable Connectors — Refer to the Mating Post Selection Guide — page 90

Accessories

Barrier Insert — page 204

Technical Documents — page 276

See mating connector for applicable product and application specifications.

No. of Pos.	Dimensions		Post Plating/Part Nos.	
	A	B	Plating A	Plating B
2	.084 [2.13]	—	1-87215-0	87227-1
4	.184 [4.67]	.100 [2.54]	1-87215-1	87227-2
6	.284 [7.21]	.200 [5.08]	1-87215-2	87227-3
8	.384 [9.75]	.300 [7.62]	87215-1	87227-4
10	.484 [12.29]	.400 [10.16]	87215-2	87227-5
12	.584 [14.83]	.500 [12.70]	87215-3	87227-6
14	.684 [17.37]	.600 [15.24]	87215-4	87227-7
16	.784 [19.91]	.700 [17.78]	87215-5	87227-8
18	.884 [22.45]	.800 [20.32]	87215-6	87227-9
20	.984 [24.99]	.900 [22.86]	87215-7	1-87227-0
22	1.084 [27.53]	1.000 [25.40]	1-87215-3	1-87227-1
24	1.184 [30.07]	1.100 [27.94]	87215-8	1-87227-2
26	1.284 [32.61]	1.200 [30.48]	87215-9	1-87227-3
28	1.384 [35.15]	1.300 [33.02]	1-87215-4	1-87227-4
30	1.484 [37.69]	1.400 [35.56]	1-87215-5	1-87227-5
32	1.584 [40.23]	1.500 [38.10]	1-87215-6	1-87227-6
34	1.684 [42.77]	1.600 [40.64]	1-87215-7	1-87227-7
36	1.784 [45.31]	1.700 [43.18]	1-87215-8	1-87227-8
38	1.884 [47.85]	1.800 [45.72]	1-87215-9	1-87227-9
40	1.984 [50.39]	1.900 [48.26]	2-87215-0	2-87227-0

Note: All part numbers are RoHS compliant.

**Standard Headers—Unshrouded, Double-Row,
 .100 x .100 [2.54 x 2.54] Centerline** (Continued)

No. of Pos.	Dimensions		Post Plating/Part Nos.	
	A	B	Plating A	Plating B
42	2.084 [52.93]	2.000 [50.80]	2-87215-1	2-87227-1
44	2.184 [55.47]	2.100 [53.34]	2-87215-2	2-87227-2
46	2.284 [58.01]	2.200 [55.88]	2-87215-3	2-87227-3
48	2.384 [60.55]	2.300 [58.42]	2-87215-4	2-87227-4
50	2.484 [63.09]	2.400 [60.96]	2-87215-5	2-87227-5
52	2.584 [65.63]	2.500 [63.50]	2-87215-6	2-87227-6
54	2.684 [68.17]	2.600 [66.04]	2-87215-7	2-87227-7
56	2.784 [70.71]	2.700 [68.58]	2-87215-8	2-87227-8
58	2.884 [73.25]	2.800 [71.12]	2-87215-9	2-87227-9
60	2.984 [75.79]	2.900 [73.66]	3-87215-0	3-87227-0
62	3.084 [78.33]	3.000 [76.20]	3-87215-1	3-87227-1
64	3.184 [80.87]	3.100 [78.74]	3-87215-2	3-87227-2
66	3.284 [83.41]	3.200 [81.28]	3-87215-3	3-87227-3
68	3.384 [85.95]	3.300 [83.82]	3-87215-4	3-87227-4
70	3.484 [88.49]	3.400 [86.36]	3-87215-5	3-87227-5
72	3.584 [91.03]	3.500 [88.90]	3-87215-6	3-87227-6
74	3.684 [93.57]	3.600 [91.44]	3-87215-7	3-87227-7
76	3.784 [96.11]	3.700 [93.98]	3-87215-8	3-87227-8
78	3.884 [98.65]	3.800 [96.52]	3-87215-9	3-87227-9
80	3.984 [101.19]	3.900 [99.06]	4-87215-0	4-87227-0

Note: All part numbers are RoHS compliant.

Standard Headers—Unshrouded, Double-Row, .100 x .100 [2.54 x 2.54] Centerline (Continued)

.025 [0.64] Square Right-Angle Post



Material and Finish

Housing — Black thermoplastic, 94V-0 rated

Posts — Copper alloy, plated as follows:

Plating A — Selectively plated .000030 [0.00076] gold on contact area, with gold flash over .000050 [0.00127] nickel on entire post

Plating B — Selectively plated .000015 [0.00038] gold on contact area, with gold flash over .000050 [0.00127] nickel on entire post

Tin/Nickel — Plating option available; minimum order quantities may apply. Consult Tyco Electronics.

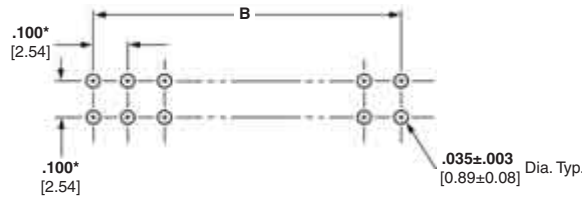
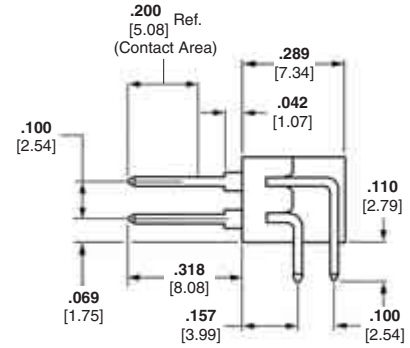
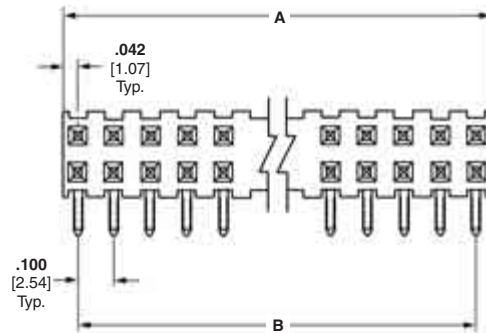

Recommended PC Board Hole Layout (for .055 [1.40] min. thick PC board)

*±.003 [±0.08] tolerances not to accumulate within one connector pattern.

Related Product Data

Mateable Connectors — Refer to the Mating Post Selection Guide — page 90

Technical Documents — page 276

See mating connector for applicable product and application specifications.

No. of Pos.	Dimensions		Post Plating/Part Nos.	
	A	B	Plating A	Plating B
2	.084 [2.13]	—	1-86479-3	87230-1
4	.184 [4.67]	.100 [2.54]	1-86479-4	87230-2
6	.284 [7.21]	.200 [5.08]	1-86479-5	87230-3
8	.384 [9.75]	.300 [7.62]	1-86479-6	87230-4
10	.484 [12.29]	.400 [10.16]	86479-3	87230-5
12	.584 [14.83]	.500 [12.70]	86479-4	87230-6
14	.684 [17.37]	.600 [15.24]	86479-5	87230-7
16	.784 [19.91]	.700 [17.78]	86479-2	87230-8
18	.884 [22.45]	.800 [20.32]	86479-6	87230-9
20	.984 [24.99]	.900 [22.86]	86479-1	1-87230-0
22	1.084 [27.53]	1.000 [25.40]	1-86479-7	1-87230-1
24	1.184 [30.07]	1.100 [27.94]	86479-7	1-87230-2
26	1.284 [32.61]	1.200 [30.48]	1-86479-0	1-87230-3
28	1.384 [35.15]	1.300 [33.02]	1-86479-8	1-87230-4
30	1.484 [37.69]	1.400 [35.56]	1-86479-9	1-87230-5
32	1.584 [40.23]	1.500 [38.10]	2-86479-0	1-87230-6
34	1.684 [42.77]	1.600 [40.64]	2-86479-1	1-87230-7
36	1.784 [45.31]	1.700 [43.18]	2-86479-2	1-87230-8
38	1.884 [47.85]	1.800 [45.72]	2-86479-3	1-87230-9
40	1.984 [50.39]	1.900 [48.26]	2-86479-4	2-87230-0

Note: All part numbers are RoHS compliant.

**Standard Headers—Unshrouded, Double-Row,
 .100 x .100 [2.54 x 2.54] Centerline** (Continued)

No. of Pos.	Dimensions		Post Plating/Part Nos.	
	A	B	Plating A	Plating B
42	2.084 [52.93]	2.000 [50.80]	2-86479-5	2-87230-1
44	2.184 [55.47]	2.100 [53.34]	2-86479-6	2-87230-2
46	2.284 [58.01]	2.200 [55.88]	2-86479-7	2-87230-3
48	2.384 [60.55]	2.300 [58.42]	2-86479-8	2-87230-4
50	2.484 [63.09]	2.400 [60.96]	2-86479-9	2-87230-5
52	2.584 [65.63]	2.500 [63.50]	3-86479-0	2-87230-6
54	2.684 [68.17]	2.600 [66.04]	3-86479-1	2-87230-7
56	2.784 [70.71]	2.700 [68.58]	3-86479-2	2-87230-8
58	2.884 [73.25]	2.800 [71.12]	3-86479-3	2-87230-9
60	2.984 [75.79]	2.900 [73.66]	3-86479-4	3-87230-0
62	3.084 [78.33]	3.000 [76.20]	3-86479-5	3-87230-1
64	3.184 [80.87]	3.100 [78.74]	3-86479-6	3-87230-2
66	3.284 [83.41]	3.200 [81.28]	3-86479-7	3-87230-3
68	3.384 [85.95]	3.300 [83.82]	3-86479-8	3-87230-4
70	3.484 [88.49]	3.400 [86.36]	3-86479-9	3-87230-5
72	3.584 [91.03]	3.500 [88.90]	4-86479-0	3-87230-6
74	3.684 [93.57]	3.600 [91.44]	4-86479-1	3-87230-7
76	3.784 [96.11]	3.700 [93.98]	4-86479-2	3-87230-8
78	3.884 [98.65]	3.800 [96.52]	4-86479-3	3-87230-9
80	3.984 [101.19]	3.900 [99.06]	4-86479-4	4-87230-0

Note: All part numbers are RoHS compliant.

Standard Headers—Unshrouded, Triple-Row, .100 [2.54] Centerline

.025 [0.64] Square Straight Post

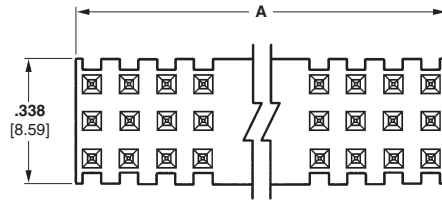
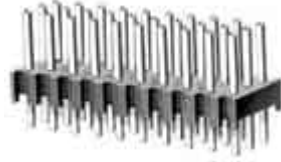

Material and Finish

Housing — Black thermoplastic, 94V-0 rated

Posts — Phosphor bronze, duplex plated 000030 [0.00076] gold on contact area, .000100-.000200 [0.00254-0.00508] tin on solder area, with entire post underplated .000050 [0.00127] nickel

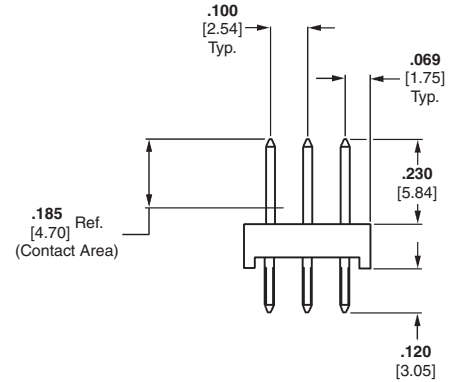
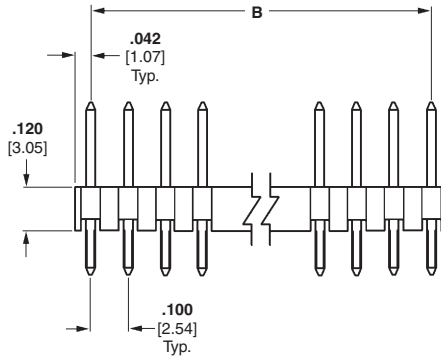

Technical Documents — page 276

See mating connector for applicable product and application specifications.

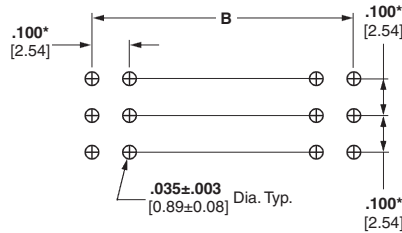

Recommended PC Board Hole Layout (for .055 [1.40] min. thick PC board)

*±.003 [±0.08] tolerances not to accumulate within one connector pattern.

Unshrouded Headers



5

No. of Pos.	Dimensions		Part Nos.
	A	B	
9	.284 [7.21]	.200 [5.08]	5-103817-1
12	.384 [9.75]	.300 [7.62]	5-103817-2
15	.484 [12.29]	.400 [10.16]	5-103817-3
18	.584 [14.83]	.500 [12.70]	5-103817-4
21	.684 [17.37]	.600 [15.24]	5-103817-5
24	.784 [19.91]	.700 [17.78]	5-103817-6
27	.884 [22.45]	.800 [20.32]	5-103817-7
30	.984 [24.99]	.900 [22.86]	5-103817-8
33	1.084 [27.53]	1.000 [25.40]	5-103817-9
42	1.384 [35.15]	1.300 [33.02]	6-103817-2
45	1.484 [37.69]	1.400 [35.56]	6-103817-3
60	1.984 [50.39]	1.900 [48.26]	6-103817-8
69	2.284 [58.01]	2.200 [55.88]	7-103817-1
72	2.384 [60.55]	2.300 [58.42]	7-103817-2
96	3.184 [80.87]	3.100 [78.74]	8-103817-0
120	3.984 [101.19]	3.900 [99.06]	8-103817-8

Note: All part numbers are RoHS compliant.

Breakaway and Retention Headers—Unshrouded

Product Facts

- Design and inventory versatility—headers can be broken into any size needed
- Variety of popular sizes available
- Substantial time/labor savings can install all posts at one time
- Vertical and right-angle versions available in single- and double-row configurations
- Phosphor bronze posts
- Choice of gold duplex or tin plated posts
- Post lengths include .230 [5.84] and .318 [8.08] for connector mating
- Board retention feature available
- Black, glass-filled thermoplastic housings; high temperature compatible
- Recognized under the Component Program of Underwriters Laboratories Inc., File No. E28476 
- Certified by Canadian Standards Association, File No. LR 7189 



Performance Characteristics

Electrical

Insulation Resistance — 5,000 megohms minimum initial

Dielectric Withstanding Voltage — 750 V rms at sea level

Environmental

Operating Temperature — -65°C to +105°C (black thermoplastic housings)

Current — 3 amperes maximum per contact (dependent upon mating receptacle)

Breakaway Headers—Unshrouded, Single-Row, .100 [2.54] Centerline

.025 [0.64] Square Straight Posts



Material and Finish

Housing — Black thermoplastic, 94V-0 rated, high temperature compatible

Posts — Phosphor bronze, plated as follows:

Plating A — Duplex plated .000030 [0.00076] gold on contact area, .000100-.000200 [0.00254-0.00508] tin on solder tail, with entire post underplated .000050 [0.00127] nickel

Plating B — Duplex plated .000015 [0.00038] gold on contact area, .000100-.000200 [0.00254-0.00508] tin on solder tail, with entire post underplated .000050 [0.00127] nickel

Plating C — .000100-.000200 [0.00254-0.00508] tin over .000050 [0.00127] nickel

Performance Characteristics (Board Retention Tails)

Insertion Force — 12 lb [53.4N] max.

Retention Force — .25 lb [1.11N] min.

Related Product Data

Mateable Connectors — Refer to the Mating Post Selection Guide — page 90

Technical Documents — page 276

See mating connector for applicable product and application specifications.

Headers with Solder Tails

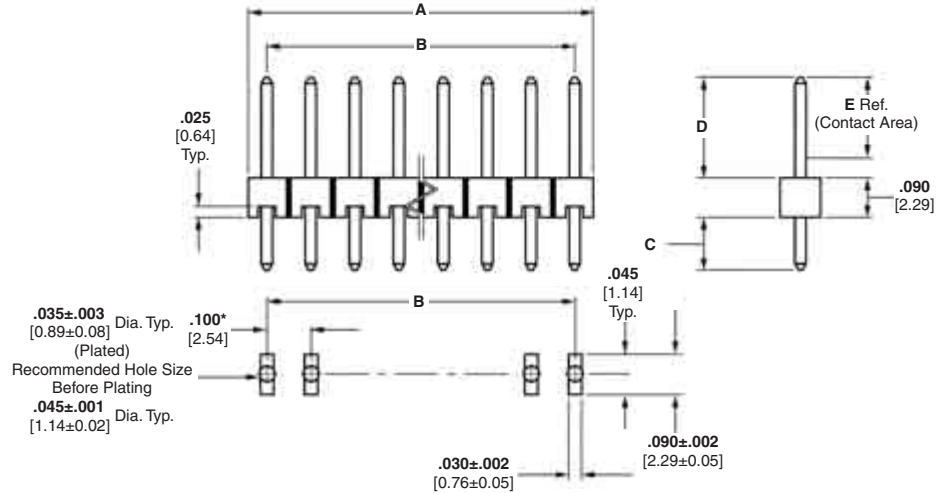

Recommended PC Board Mounting Pattern (for .062 [1.57] thick PC board; .008 [2.03] thick stencil)

*±.003 [±0.08] tolerances not to accumulate within one connector pattern.

Headers with Board Retention Tails

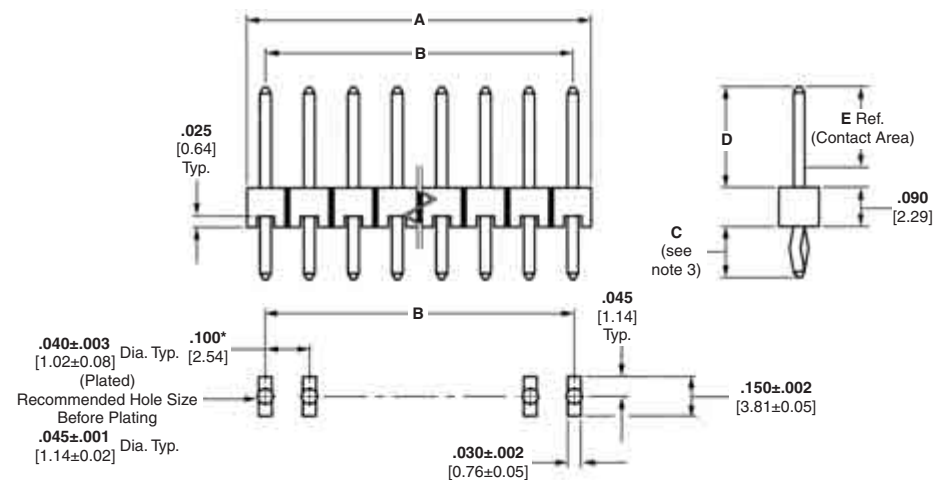

Recommended PC Board Mounting Pattern (for .062 [1.57] thick PC board; .008 [2.03] thick stencil)

*±.003 [±0.08] tolerances not to accumulate within one connector pattern.

Header Style	No. of Pos.	Dimensions		C = .090 [2.29] D = .230 [5.84] E = .185 [4.70]			C = .120 [3.05] D = .230 [5.84] E = .185 [4.70]			C = .125 [3.18] D = .318 [8.08] E = .200 [5.08]		
		A	B	Post Plating/Part Nos.			Post Plating/Part Nos.			Post Plating/Part Nos.		
				Plating A	Plating B	Plating C	Plating A	Plating B	Plating C	Plating A	Plating B	Plating C
With Solder Tails (See Notes 1 and 2.)	1	.084 [2.13]	—	5-146285-1	5-146284-1	5-146282-1	5-146281-1	5-146280-1	5-146278-1	5-146277-1	5-146276-1	5-146274-1
	40	3.984 [101.19]	3.900 [99.06]	9-146285-0	9-146284-0	9-146282-0	9-146281-0	9-146280-0	9-146278-0	9-146277-0	9-146276-0	9-146274-0
With Board Retention Tails (See Notes 2 and 3.)	3	.284 [7.21]	.200 [5.08]	5-146297-3	5-146296-3	5-146294-3	5-146293-3	5-146292-3	5-146290-3	5-146289-3	5-146288-3	5-146286-3
	40	3.984 [101.19]	3.900 [99.06]	9-146297-0	9-146296-0	9-146294-0	9-146293-0	9-146292-0	9-146290-0	9-146289-0	9-146288-0	9-146286-0

- Notes:** 1. Headers without retention tails may be broken to the desired number of positions using **Tool Kit No. 314818-1 (not shown)**.
 2. Headers are also available in sizes 2 thru 39 positions (with Solder Tails) and 4 thru 39 positions (with Board Retention Tails). When ordering, add the prefix and/or suffix (dash) numbers plus 5- -0 to the base part number that corresponds with the desired size. For example, the complete part number for an 8-position header with solder tails (C dimension .090 [2.29], post plating A) would be 5-146285-8. The complete part number for a 26-position header with board retention tails (C dimension .120 [3.05], post plating B) would be 7-146292-6. This part numbering system applies only to this page.
 3. For C dimensions .120 [3.05] and .125 [3.18], board retention using kinked tails are for headers 6 positions and smaller; headers 7 positions and larger use swaged tails. Headers with a C dimension of .090 [2.29] have swaged tails for all sizes.

Note: All part numbers are RoHS compliant.

Breakaway Headers—Unshrouded, Single-Row, .100 [2.54] Centerline (Continued)

.025 [0.64] Square Right-Angle Posts



Material and Finish

Housing — Black thermoplastic, 94V-0 rated, high temperature compatible

Posts — Phosphor bronze, duplex plated .000030 [0.00076] gold on contact area, .000100-.000200 [0.00254-0.00508] matte tin on solder tail, with entire post underplated .000050 [0.00127] nickel

Performance Characteristics (Board Retention Tails)

Insertion Force — 12 lb [53.4N] max.

Retention Force — .25 lb [1.11N] min.

Related Product Data

Mateable Connectors — Refer to the Mating Post Selection Guide — page 90

Technical Documents — page 276

See mating connector for applicable product and application specifications.

Headers with Solder Tails

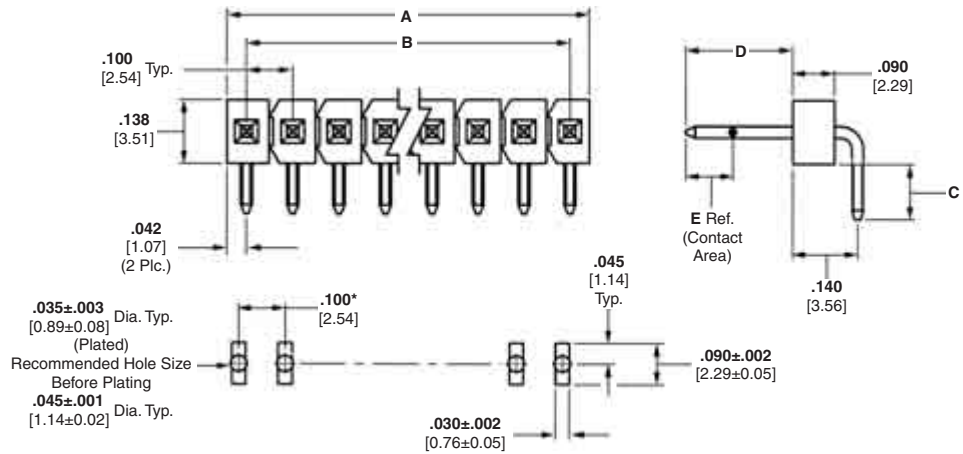

Recommended PC Board Mounting Pattern
(for .062 [1.57] thick PC board; .008 [.203] thick stencil)
*±.003 [±0.08] tolerances not to accumulate within one connector pattern.

Headers with Board Retention Tails

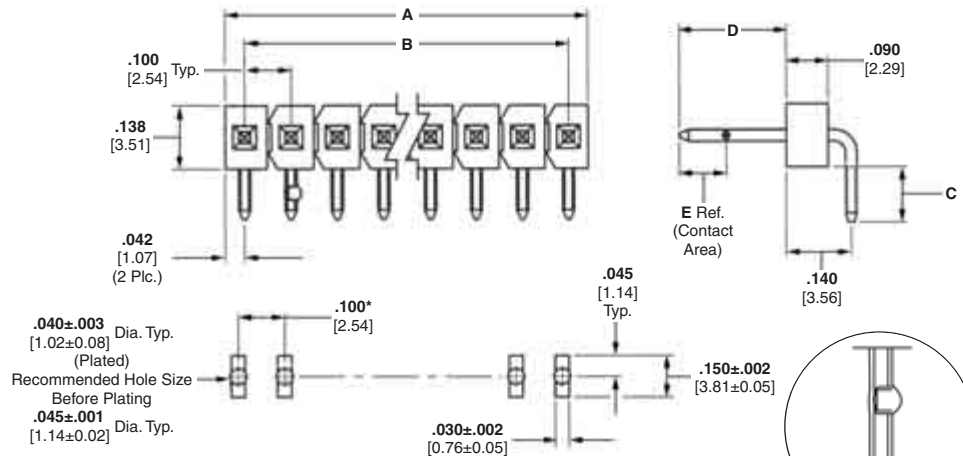

Recommended PC Board Mounting Pattern
(for .062 [1.57] thick PC board; .008 [.203] thick stencil)
*±.003 [±0.08] tolerances not to accumulate within one connector pattern.

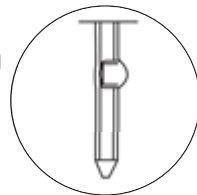

Board Retention Tails using Swaged Tails
(All Header Sizes)

Header Style	No. of Pos.	Dimensions		C = .120 [3.05] D = .230 [5.84] E = .185 [4.70]			C = .110 [2.79] D = .318 [8.08] E = .200 [5.08]		
		A	B	Part Nos.			Part Nos.		
With Solder Tails (See Notes 1 and 2.)	1	.084 [2.13]	—	5-146304-1			5-146305-1		
	40	3.984 [101.19]	3.900 [99.06]	9-146304-0			9-146305-0		
With Board Retention Tails (See Note 2.)	3	.084 [2.13]	—	5-146306-3			5-146307-3		
	40	3.984 [101.19]	3.900 [99.06]	9-146306-0			9-146307-0		

Notes: 1. Headers without retention tails may be broken to the desired number of positions using **Tool Kit No. 314818-1 (not shown)**.
2. Headers are also available in sizes 2 thru 39 positions (with Solder Tails) and 4 thru 39 positions (with Board Retention Tails).
When ordering, add the prefix and/or suffix (dash) numbers plus 5- -0 to the base part number that corresponds with the number of positions. For example, the complete part number for an 8-position header with solder tails (C dimension .120 [3.05]) would be 5-146304-8. The complete part number for a 26-position header with board retention tails (C dimension .120 [3.05]) would be 7-146306-6. This part numbering system applies only to this page.

Note: All part numbers are RoHS compliant.

Breakaway Headers—Unshrouded, Double-Row, .100 x .100 [2.54 x 2.54] Centerline

.025 [0.64] Square Straight Posts



Material and Finish

Housing — Black thermoplastic, 94V-0 rated, high temperature compatible

Posts — Phosphor bronze, plated as follows:

Plating A — Duplex plated .000030 [0.00076] gold on contact area, .000100-.000200 [0.00254-0.00508] tin on solder tail, with entire post underplated .000050 [0.00127] nickel

Plating B — Duplex plated .000015 [0.00038] gold on contact area, .000100-.000200 [0.00254-0.00508] tin on solder tail, with entire post underplated .000050 [0.00127] nickel

Plating C — .000100-.000200 [0.00254-0.00508] tin over .000050 [0.00127] nickel

Performance Characteristics (Board Retention Tails)

Insertion Force — 12 lb [53.4N] max.

Retention Force — .25 lb [1.11N] min.

Related Product Data

Mateable Connectors — Refer to the Mating Post Selection Guide — page 90

Technical Documents — page 276

See mating connector for applicable product and application specifications.

Headers with Solder Tails

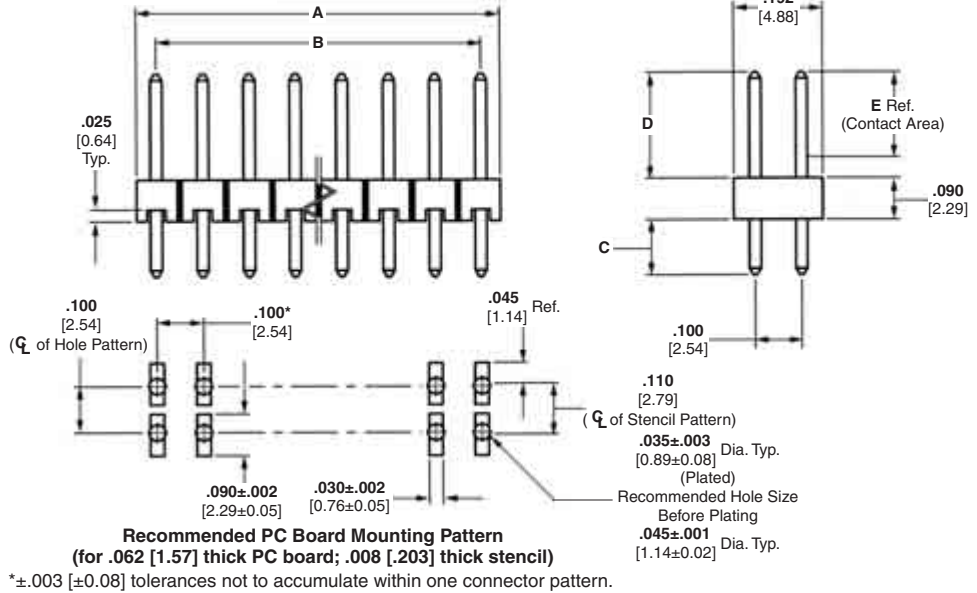

Headers with Board Retention Tails

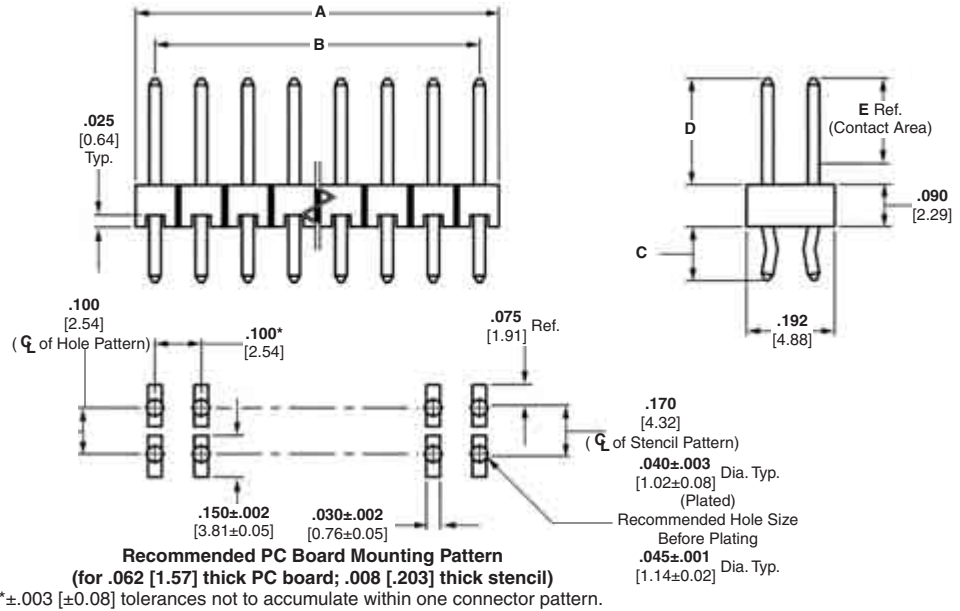

Header Style	No. of Pos.	Dimensions		C = .090 [2.29] D = .230 [5.84] E = .185 [4.70]			C = .120 [3.05] D = .230 [5.84] E = .185 [4.70]			C = .125 [3.18] D = .318 [8.08] E = .200 [5.08]		
		A	B	Post Plating/Part Nos.			Post Plating/Part Nos.			Post Plating/Part Nos.		
				Plating A	Plating B	Plating C	Plating A	Plating B	Plating C	Plating A	Plating B	Plating C
With Solder Tails (See Notes 1 and 2)	2	.084 [2.13]	—	5-146261-1	5-146260-1	5-146258-1	5-146257-1	5-146256-1	5-146254-1	5-146253-1	5-146252-1	5-146250-1
	80	3.984 [101.19]	3.900 [99.06]	9-146261-0	9-146260-0	9-146258-0	9-146257-0	9-146256-0	9-146254-0	9-146253-0	9-146252-0	9-146250-0
With Board Retention Tails (See Note 2)	2	.084 [2.13]	—	5-146273-1	5-146272-1	5-146270-1	5-146269-1	5-146268-1	5-146266-1	5-146265-1	5-146264-1	5-146262-1
	80	3.984 [101.19]	3.900 [99.06]	9-146273-0	9-146272-0	9-146270-0	9-146269-0	9-146268-0	9-146266-0	9-146265-0	9-146264-0	9-146262-0

Notes: 1. Headers without retention tails may be broken to the desired number of positions using **Tool Kit No. 314818-1 (not shown)**.
2. Headers are also available in sizes 4 thru 78 positions. When ordering, add the prefix and/or suffix (dash) numbers plus 5-0 to the base part number that corresponds with the number of positions per row. For example, the complete part number for a 16-position header with solder tails (C dimension .090 [2.29], post plating A) would be 5-146261-8. The complete part number for a 40-position header with board retention tails (C dimension .120 [3.05], post plating B) would be 7-146268-0. This part numbering system applies only to this page.

Note: All part numbers are RoHS compliant.

Breakaway Headers—Unshrouded, Double-Row, .100 x .100 [2.54 x 2.54] Centerline (Continued)

.025 [0.64] Square Right-Angle Posts



Material and Finish

Housing — Black thermoplastic, 94V-0 rated, high temperature compatible

Posts — Phosphor bronze, duplex plated .000030 [0.00076] gold on contact area, .000100-.000200 [0.00254-0.00508] tin on solder tail, with entire post underplated .000050 [0.00127] nickel

Performance Characteristics (Board Retention Tails)

Insertion Force — 12 lb [53.4N] max.

Retention Force — .25 lb [1.11N] min.

Related Product Data

Mateable Connectors — Refer to the Mating Post Selection Guide — page 90

Technical Documents — page 276

See mating connector for applicable product and application specifications.

Headers with Solder Tails

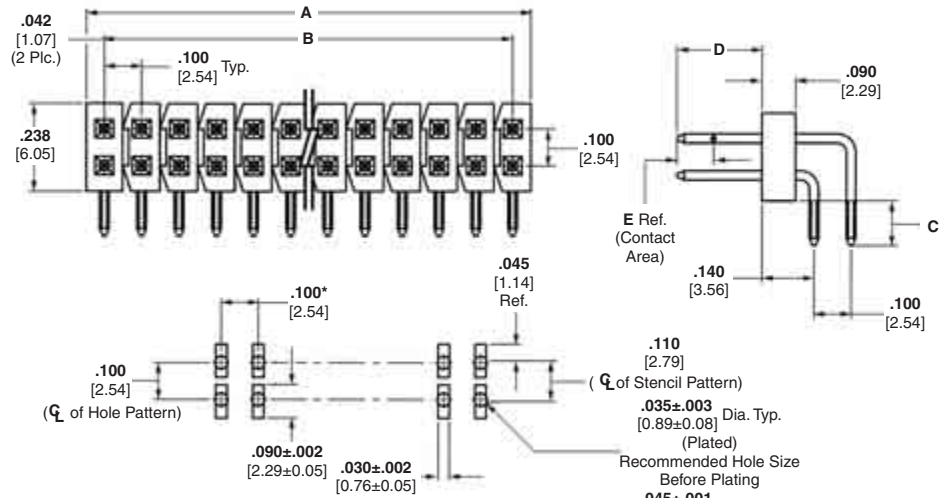

Recommended PC Board Mounting Pattern
(for .062 [1.57] thick PC board; .008 [.203] thick stencil)
*±.003 [±0.08] tolerances not to accumulate within one connector pattern.

Headers with Board Retention Tails

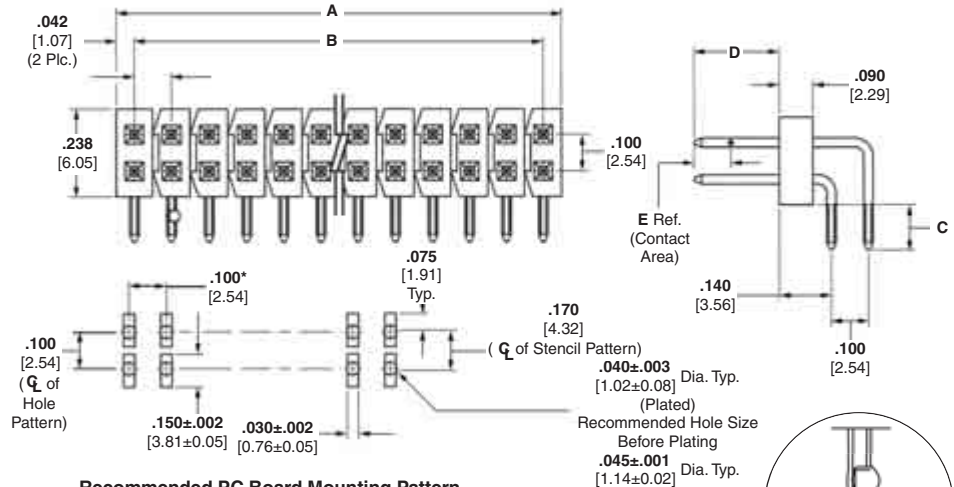

Recommended PC Board Mounting Pattern
(for .062 [1.57] thick PC board; .008 [.203] thick stencil)
*±.003 [±0.08] tolerances not to accumulate within one connector pattern.

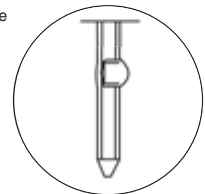

Board Retention using Swaged Tails (All Header Sizes)

Header Style	No. of Pos.	Dimensions		C = .120 [3.05] D = .230 [5.84] E = .185 [4.70] Part Nos.		C = .110 [2.79] D = .318 [8.08] E = .200 [5.08] Part Nos.	
		A	B				
With Solder Tails (See Notes 1 and 2.)	2	.084 [2.13]	—	5-146308-1	5-146309-1		
	80	3.984 [101.19]	3.900 [99.06]	9-146308-0	9-146309-0		
With Board Retention Tails (See Note 2.)	2	.084 [2.13]	—	5-146310-1	5-146311-1		
	80	3.984 [101.19]	3.900 [99.06]	9-146310-0	9-146311-0		

Notes: 1. Headers without retention tails may be broken to the desired number of positions using **Tool Kit No. 314818-1** (not shown).
2. Headers are also available in sizes 4 thru 78 positions. When ordering, add the prefix and/or suffix (dash) numbers plus 5-0 to the base part number that corresponds with the number of positions per row. For example, the complete part number for a 16-position header with solder tails (C dimension .120 [3.05]) would be 5-146308-8. The complete part number for a 40-position header with board retention tails (C dimension .120 [3.05]) would be 7-146310-0. This part numbering system applies only to this page.

Note: All part numbers are RoHS compliant.

AMPMODU Reeled Breakaway Headers

Features of Breakaway Headers

- Design and inventory versatility — headers can easily be made into a variety of sizes
- High Temperature Compatible
- Reduced part number base
- Reduced inventory burden

Applications

- Desktops & workstations
- Set-top boxes
- Televisions
- Automotive instrument panels & radios
- Medical and test equipment

Benefits

- Off the shelf availability
- Various header length capability using the same reel
- Reduction of inventory costs
- Economy version of the standard breakaway headers

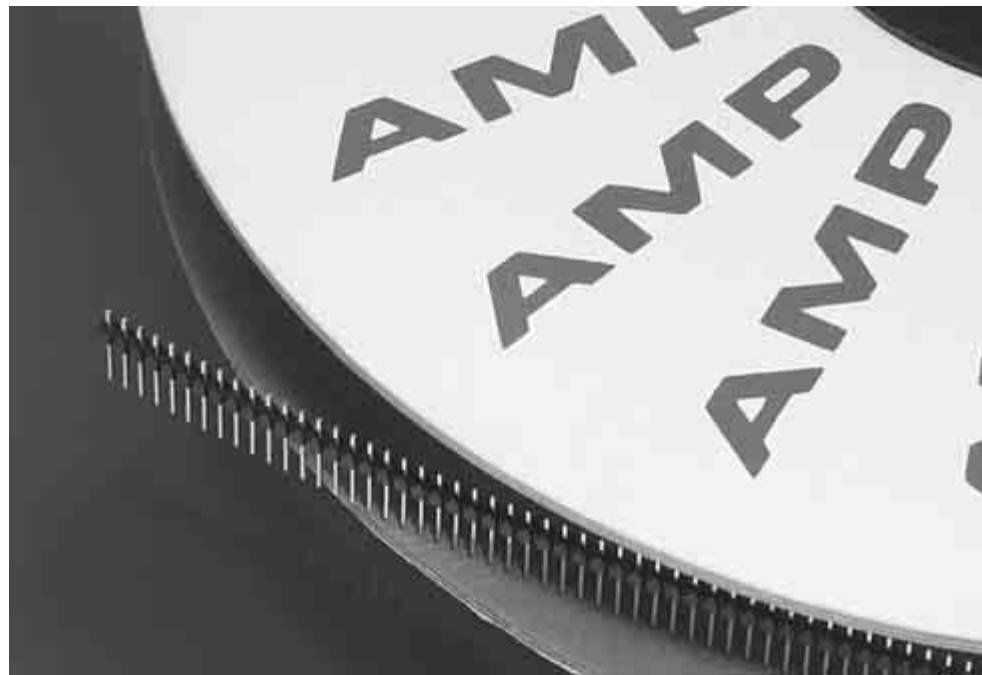

Tyco Electronics now offers AMPMODU reeled breakaway headers, which are used for board-to-board interconnections, on a continuous reel. The reeled breakaway headers are an economy version of the standard breakaway headers, and continue to provide the same high quality standards that Tyco Electronics is known for in the connector industry.

Reeled breakaway headers provide the flexibility to cut the headers to many different lengths, while only having to stock one part number. As a result, the amount of part numbers that need to be purchased and stored can be greatly reduced.

Reeled breakaway headers can be purchased in single and double rows with tin, 5 Au, 15 Au, and 30 Au duplex plating. The lower applied cost also offers .230" and .318" mating lengths. (See standard breakaway-to-reeled header conversion chart for vertical headers on the reverse side of this sheet)

Potential industries include: computer peripherals, telecommunications equipment, consumer, automotive, medical and test equipment.

Tooling available from:
Robo-Pak, Inc.
814 Lakeshore Drive
East Bethel, MN 55902

A pin retention and pin removal tooling option is also available in addition to cutting.

AMPMODU Reeled Breakaway Headers (Continued)

Single Row

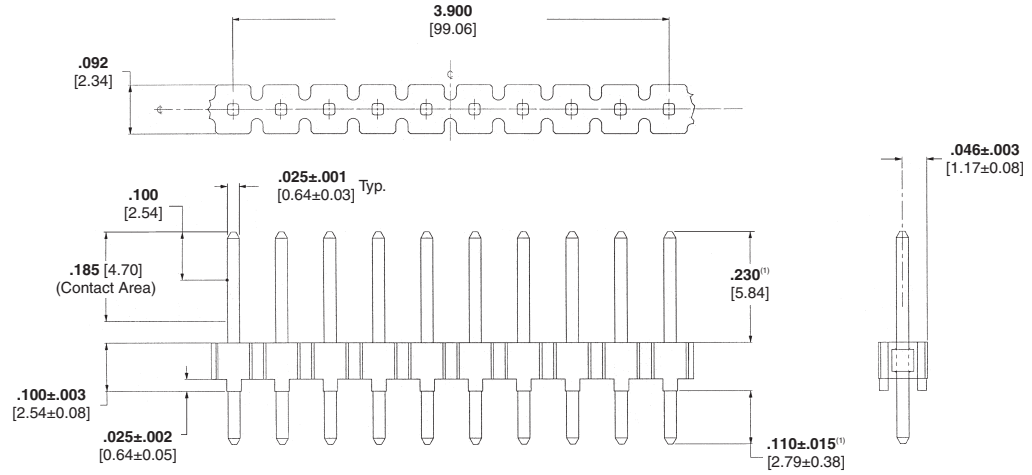

Double Row

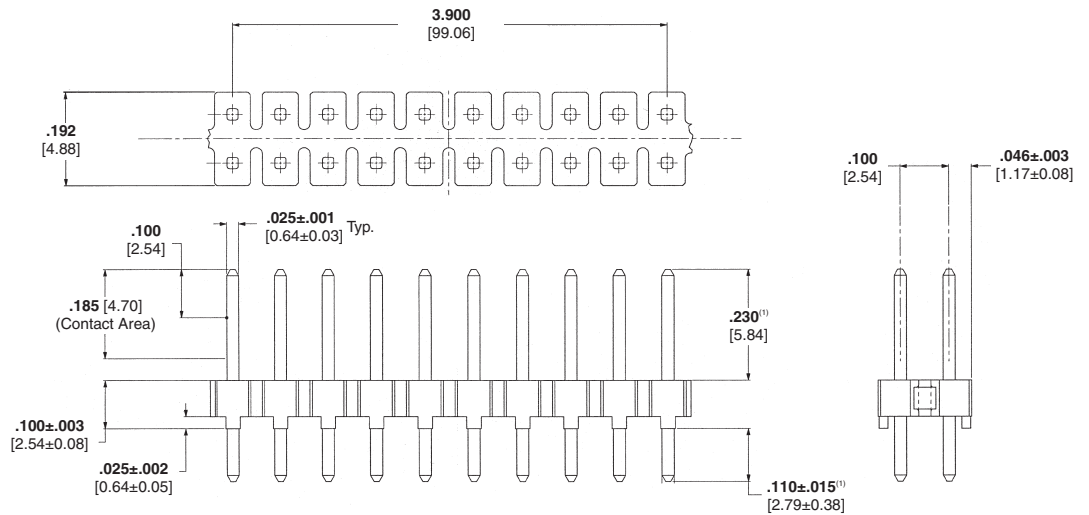

(1) See table for other mate and tail lengths.

Standard Breakaway-to-Reeled Header Conversion Chart (Vertical)								
Plating Options	Double Row Headers				Single Row Headers			
	Existing Tyco Electronics P/N	Make From Reeled P/N	Existing Tyco Electronics P/N	Make From Reeled P/N	Existing Tyco Electronics P/N	Make From Reeled P/N	Existing Tyco Electronics P/N	Make From Reeled P/N
	Mate: .318 Tail: .125	Mate: .318 Tail: .115	Mate: .230 Tail: .120	Mate: .230 Tail: .110	Mate: .318 Tail: .125	Mate: .318 Tail: .115	Mate: .230 Tail: .120	Mate: .230 Tail: .110
Tin	103322	5-146853-1	103328	5-146851-1	103321	5-146852-1	103327	5-146850-1
	146250		146254		146274		146278	
15 Au Duplex	102973	5-146861-1	103186	5-146859-1	102972	5-146860-1	103185	5-146858-1
	146252		146256		146276		146280	
30 Au Duplex	102977	5-146871-1	103240	5-146869-1	102976	5-146870-1	103239	5-146868-1
	146253		146257		146277		146281	

Note: Reeled Headers are a functional substitute for standard breakaways, however there are visual differences (i.e. housing appearance and bow due to reeling requirement).

Note: All part numbers are RoHS compliant.

Breakaway Surface Mount Headers, .100 x .100 [2.54 x 2.54] Centerline

Product Facts

- **Surface Mount Leads**
- **Contact Material:**
phosphor bronze
- **High temperature, black thermoplastic housings, 94V-0 rated, capable of withstanding IR or vapor-phase reflow**
- **Recognized under the Component Program of Underwriters Laboratories Inc.** 
File No. E28476
- **Certified by Canadian Standards Association,** 
File No. LR 7189
- **Choice of gold duplex or tin plated posts**
- **Posts coplanar within .006 [0.15]**
- **Tape and reel packaging available in addition to single tube packaging. Contact Tyco Electronics.**
- **Pick-and-place cap available for vacuum placement. Contact Tyco Electronics.**

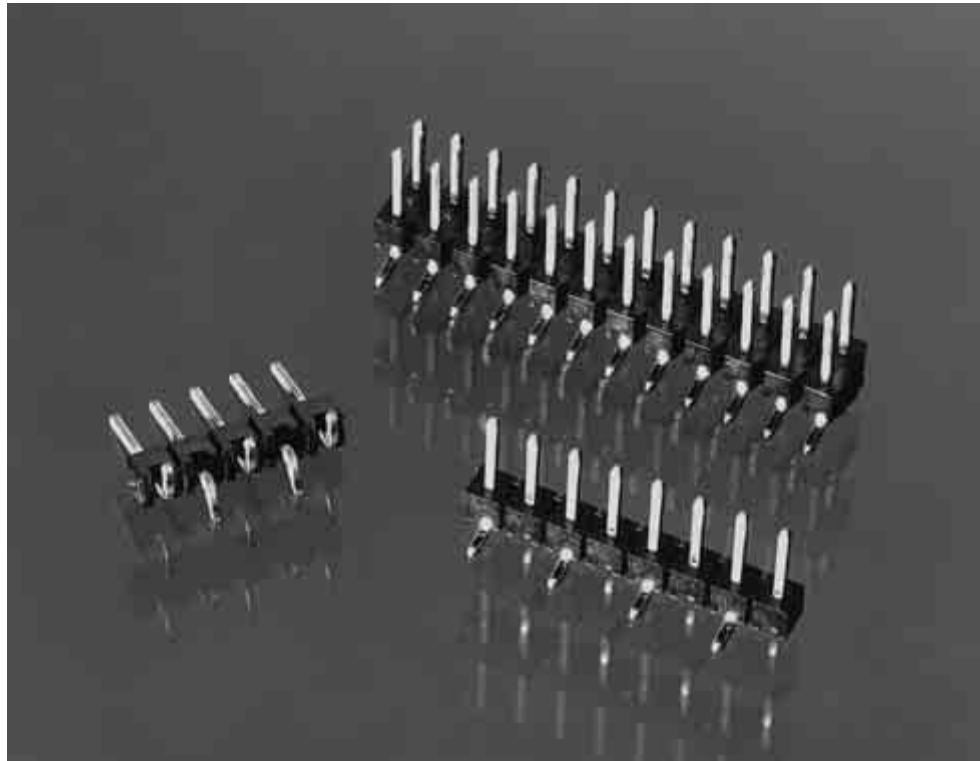

An extension of the AMPMODU Breakaway Header product family are the surface mount, vertical breakaway headers. The AMPMODU Surface Mount breakaway headers (Unshrouded) are available

in single- and double-row vertical configurations with mating lengths of .230 [5.84] and .320 [8.13]. Posts are offered with a choice of either .000030 [.0007] gold duplex or tin plating.

Current packaging is in a single tube but tape and reel is available for automatic pick-and-place. We also can provide a pick-and-place cap for vacuum placement if required.

Surface Mount
Breakaway Headers

5

Breakaway Surface Mount Headers—Unshrouded Single-Row, .100 [2.54] Centerline

.025 [0.64] Square Straight Post



Material and Finish

Housing — Black thermoplastic, 94V-0 rated

Posts — Phosphor bronze, plated as follows:

Plating A — Duplex plated .000030 [0.00076] gold on contact area, .000100-.000200 [0.00254-0.00508] tin on solder area, with entire post underplated .000050 [0.00127] nickel

Plating B — .000100-.000200 [0.00254-0.00508] tin over .000050 [0.00127] nickel entire post

Related Product Data

Mateable Receptacle — Refer to Mating Post Selection Guide — page 90

Technical Documents — page 276

See mating connector for applicable product and application specifications.

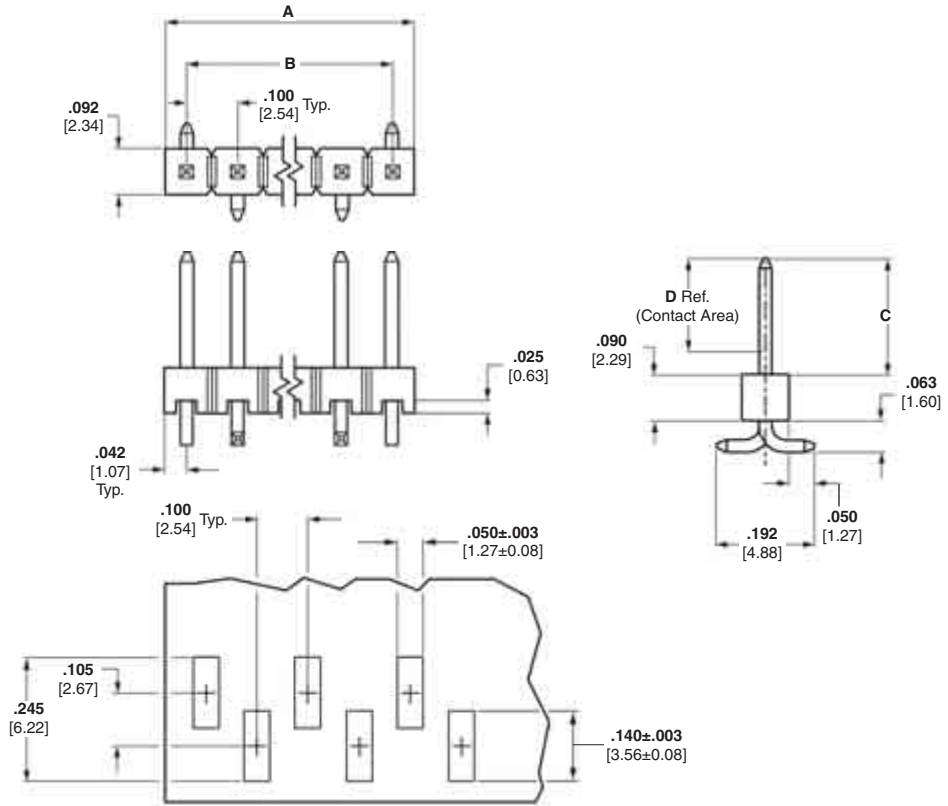

Recommended Etched Circuit Layout
(Using .008 [0.20] thick stencil)

Surface Mount
Breakaway Headers

5

No. of Pos.	Dimensions		C = .230 [5.84] D = .185 [4.70]		C = .320 [8.13] D = .200 [5.08]	
	A	B	Post Plating/Part Nos.		Post Plating/Part Nos.	
			Plating A	Plating B	Plating A	Plating B
3	.284 [7.21]	.200 [5.08]	5-146128-1	5-146132-1	5-146129-1	5-146133-1
4	.384 [9.75]	.300 [7.62]	5-146128-2	5-146132-2	5-146129-2	5-146133-2
5	.484 [12.29]	.400 [10.16]	5-146128-3	5-146132-3	5-146129-3	5-146133-3
6	.584 [14.83]	.500 [12.70]	5-146128-4	5-146132-4	5-146129-4	5-146133-4
7	.684 [17.37]	.600 [15.24]	5-146128-5	5-146132-5	5-146129-5	5-146133-5
8	.784 [19.91]	.700 [17.78]	5-146128-6	5-146132-6	5-146129-6	5-146133-6
9	.884 [22.45]	.800 [20.32]	5-146128-7	5-146132-7	5-146129-7	5-146133-7
10	.984 [24.99]	.900 [22.86]	5-146128-8	5-146132-8	5-146129-8	5-146133-8
11	1.084 [27.53]	1.000 [25.40]	5-146128-9	5-146132-9	5-146129-9	5-146133-9
12	1.184 [30.07]	1.100 [27.94]	6-146128-0	6-146132-0	6-146129-0	6-146133-0
13	1.284 [32.61]	1.200 [30.48]	6-146128-1	6-146132-1	6-146129-1	6-146133-1
14	1.384 [35.15]	1.300 [33.02]	6-146128-2	6-146132-2	6-146129-2	6-146133-2
15	1.484 [37.69]	1.400 [35.56]	6-146128-3	6-146132-3	6-146129-3	6-146133-3

Note: All part numbers are RoHS compliant.

Breakaway Surface Mount Headers—Unshrouded Double-Row, .100 x .100 [2.54 x 2.54] Centerline

.025 [0.64] Square Straight Post



Material and Finish

Housing — Black thermoplastic, 94V-0 rated

Posts — Phosphor bronze, plated as follows:

Plating A — Duplex plated .000030 [0.00076] gold on contact area, .000100-.000200 [0.00254-0.00508] tin on solder area, with entire post underplated .000050 [0.00127] nickel

Plating B — .000100-.000200 [0.00254-0.00508] tin over .000050 [0.00127] nickel entire post

Related Product Data

Mateable Receptacles — Refer to Mating Post Selection Guide — page 90

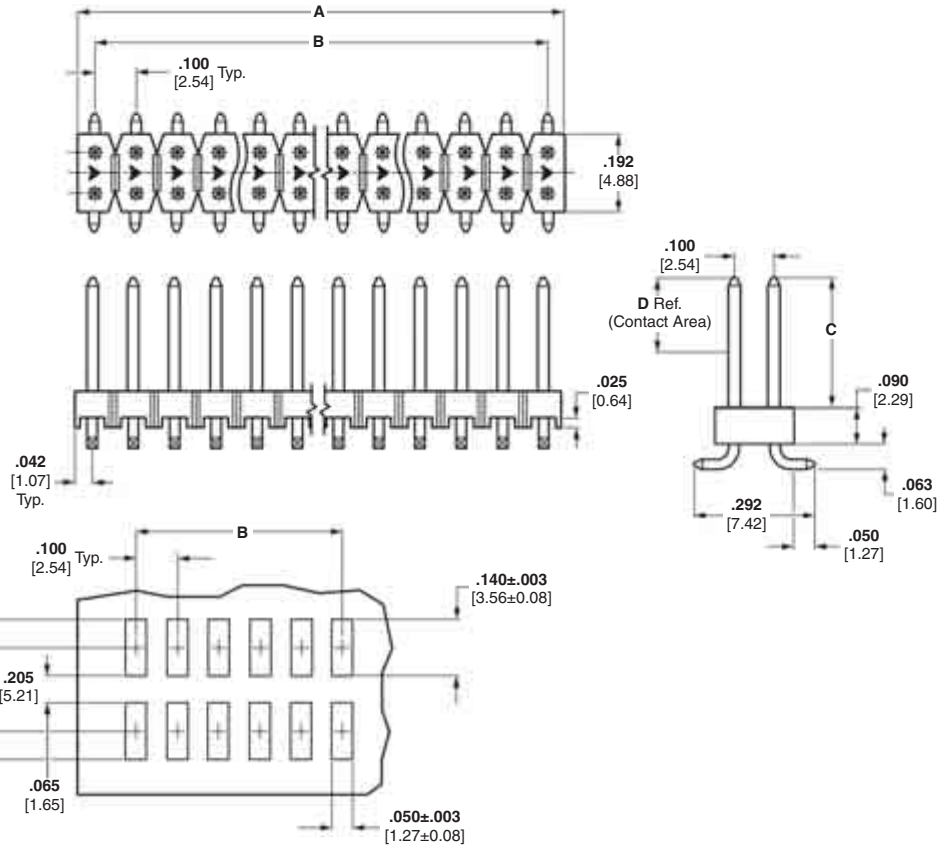

Recommended Etched Circuit Layout (Using .008 [0.20] thick stencil)

No. of Pos.	Dimensions		C = .230 [5.84] D = .185 [4.70]		C = .320 [8.13] D = .200 [5.08]	
	A	B	Post Plating/Part Nos.		Post Plating/Part Nos.	
			Plating A	Plating B	Plating A	Plating B
4	.184 [4.67]	.100 [2.54]	5-146130-1	5-146134-1	5-146131-1	5-146135-1
6	.284 [7.21]	.200 [5.08]	5-146130-2	5-146134-2	5-146131-2	5-146135-6
8	.384 [9.75]	.300 [7.62]	5-146130-3	5-146134-3	5-146131-3	5-146135-3
10	.484 [12.29]	.400 [10.16]	5-146130-4	1-146134-7	5-146131-4	5-146135-4
12	.584 [14.83]	.500 [12.70]	5-146130-5	5-146134-5	5-146131-5	5-146135-5
14	.684 [17.37]	.600 [15.24]	5-146130-6	5-146134-6	5-146131-6	5-146135-6
16	.784 [19.91]	.700 [17.78]	5-146130-7	1-146134-9	5-146131-7	5-146135-7
18	.884 [22.45]	.800 [20.32]	5-146130-8	5-146134-8	5-146131-8	5-146135-8
20	.984 [24.99]	.900 [22.86]	5-146130-9	5-146134-9	5-146131-9	5-146135-9
22	1.084 [27.53]	1.000 [25.40]	6-146130-0	6-146134-0	6-146131-0	6-146135-0
24	1.184 [30.07]	1.100 [27.94]	6-146130-1	6-146134-1	6-146131-1	6-146135-1
26	1.284 [32.61]	1.200 [30.48]	6-146130-2	6-146134-2	6-146131-2	6-146135-2
28	1.384 [35.15]	1.300 [33.02]	6-146130-3	6-146134-3	6-146131-3	6-146135-3
30	1.484 [37.69]	1.400 [35.56]	6-146130-4	2-146134-1	6-146131-4	6-146135-4

Note: All part numbers are RoHS compliant.

Unshrouded Stacking Headers—Breakaway .100 x .100 [2.54 x 2.54] Centerline

Product Facts

- Available in single and double row
- Parallel PC board stacking with numerous stack heights available
- Drawn wire posts allow 4 side mateability
- May eliminate the need for additional board spacers
- Can be used in conjunction with bottom entry receptacles
- Gold or tin plated
- Up to 1.430 [36.32] overall post length
- Retention and surface mount features available upon request
- Other header sizes can be made upon request
- Tape and reel packaging available. Contact Tyco Electronics.
- Pick-and-place cap available for vacuum placement. Contact Tyco Electronics.

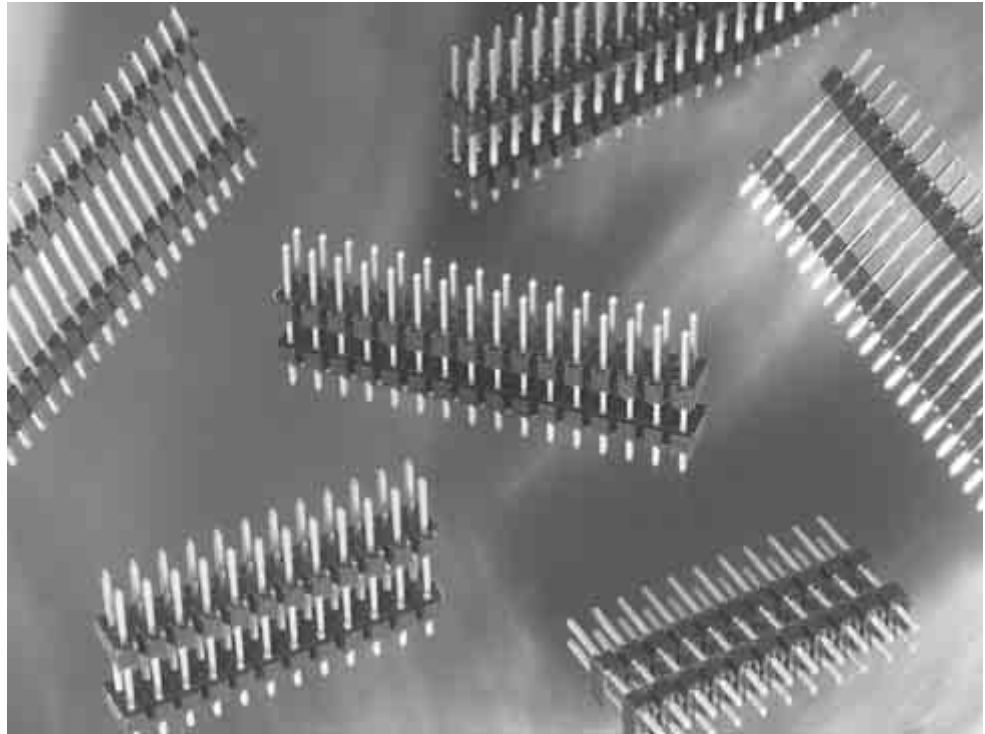

Unshrouded Stacking Headers — Breakaway, Single-Row, .100 [2.54] Centerline

.025 [0.64] Square Straight Posts

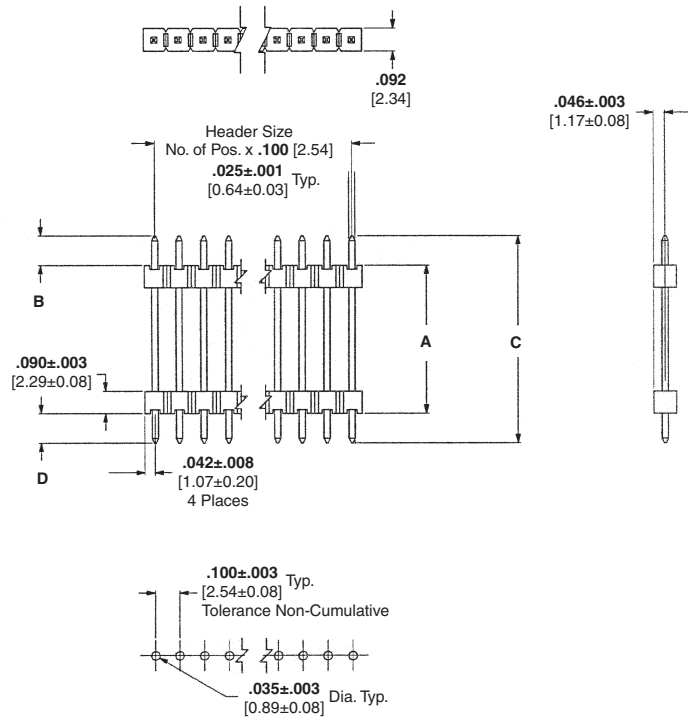

Recommended PC Board Hole Layout

Material and Finish

Housing — Black thermoplastic, 94V-0 rated

Posts — Phosphor bronze, plated as follows:

Plating — As noted in chart:

Tin — .000100-.000200 [0.00254-0.00508] tin over .000050 [0.00127] nickel entire post

15Au — .000015 [0.00038] gold over .000050 [0.00127] nickel entire post

Related Product Data

Mateable Receptacles — Refer to the Mating Post Selection Guide — page 88

Technical Documents — page 276

See mating connector for applicable product and application specifications.

Retention and surface mount features available upon request. Other header sizes can be made upon request.

***Note:** Headers are available in sizes 1 thru 40. When ordering, add the prefix and/or suffix (dash) numbers plus 5- -0 to the base part number that corresponds with the number of positions per row. For example, the complete part number for an 8-position header is 5-146455-8. The complete part number for a 16-position of the same series would be 6-146455-6.

Base Number (see note)	A Stack Height	B Tail Length	C Post Length	D Mating Length	B End Plating	D End Plating
146455	.200 [5.08]	.130 [3.30]	.440 [11.17]	.110 [2.79]	TIN	TIN
146456	.250 [6.35]	.080 [2.03]	.440 [11.17]	.110 [2.79]	TIN	TIN
146457	.250 [6.35]	.114 [2.89]	.474 [12.03]	.110 [2.79]	TIN	TIN
146458	.300 [7.62]	.123 [3.12]	.533 [13.53]	.110 [2.79]	TIN	TIN
146459	.400 [10.16]	.107 [2.71]	.617 [15.67]	.110 [2.79]	TIN	TIN
146460	.450 [11.43]	.057 [1.45]	.617 [15.67]	.110 [2.79]	TIN	TIN
146461	.500 [12.70]	.129 [3.27]	.739 [18.77]	.110 [2.79]	TIN	TIN
146462	.300 [7.62]	.109 [2.77]	.739 [18.77]	.330 [8.38]	TIN	15 AU
146463	.600 [15.24]	.107 [2.71]	.817 [20.75]	.110 [2.79]	TIN	TIN
146464	.400 [10.16]	.087 [2.20]	.817 [20.75]	.330 [8.38]	TIN	15 AU
146465	.700 [17.78]	.120 [3.05]	.930 [23.62]	.110 [2.79]	TIN	TIN
146466	.500 [12.70]	.100 [2.54]	.930 [23.62]	.330 [8.38]	TIN	15 AU
146467	.270 [6.86]	.330 [8.38]	.930 [23.62]	.330 [8.38]	15 AU	15 AU
146468	.800 [20.32]	.120 [3.05]	1.030 [26.16]	.110 [2.79]	TIN	TIN
146469	.600 [15.24]	.100 [2.54]	1.030 [26.16]	.330 [8.38]	TIN	15 AU
146470	.370 [9.39]	.330 [8.38]	1.030 [26.16]	.330 [8.38]	15 AU	15 AU
146471	.900 [22.86]	.120 [3.05]	1.130 [28.70]	.110 [2.79]	TIN	TIN
146472	.700 [17.78]	.100 [2.54]	1.130 [28.70]	.330 [8.38]	TIN	15 AU
146473	.470 [11.93]	.330 [8.38]	1.130 [28.70]	.330 [8.38]	15 AU	15 AU
146474	1.000 [25.40]	.120 [3.05]	1.230 [31.24]	.110 [2.79]	TIN	TIN
146475	.800 [20.32]	.100 [2.54]	1.230 [31.24]	.330 [8.38]	TIN	15 AU
146476	.570 [14.47]	.330 [8.38]	1.230 [31.24]	.330 [8.38]	15 AU	15 AU
146477	1.100 [27.94]	.120 [3.05]	1.330 [33.78]	.110 [2.79]	TIN	TIN
146478	.900 [22.68]	.100 [2.54]	1.330 [33.78]	.330 [8.38]	TIN	15 AU
146479	.670 [17.01]	.330 [8.38]	1.330 [33.78]	.330 [8.38]	15 AU	15 AU
146480	1.200 [30.48]	.120 [3.05]	1.430 [36.32]	.110 [2.79]	TIN	TIN
146481	1.000 [25.40]	.100 [2.54]	1.430 [36.32]	.330 [8.38]	TIN	15 AU
146482	.770 [19.55]	.330 [8.38]	1.430 [36.32]	.330 [8.38]	15 AU	15 AU

Note: All part numbers are RoHS compliant.

Unshrouded Stacking Headers — Breakaway, Double-Row, .100 x .100 [2.54 x 2.54] Centerline

.025 [0.64] Square Straight Posts

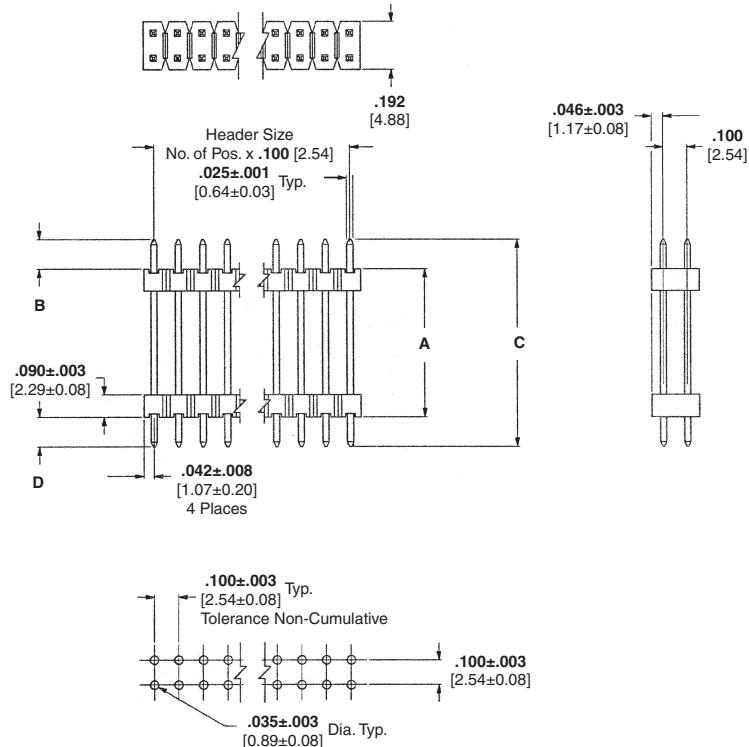

Material and Finish

Housing — Black thermoplastic, 94V-0 rated

Posts — Phosphor bronze, plated as follows:

Plating — As noted in chart:

Tin — .000100-.000200 [0.00254-0.00508] tin over .000050 [0.00127] nickel entire post

15Au — .000015 [0.00038] gold over .000050 [0.00127] nickel entire post

Related Product Data

Mateable Connectors —

Refer to the Mating Post Selection Guide — page 90

Technical Documents — page 276

See mating connector for applicable product and application specifications.

Retention and surface mount features available upon request. Other header sizes can be made upon request.

***Note:** Headers are available in sizes 2 thru 80. When ordering, add the prefix and/or suffix (dash) numbers plus 5- -0 to the base part number that corresponds with the number of positions per row. For example, the complete part number for a 16-position header is 5-146283-8. The complete part number for a 32-position of the same series would be 6-146283-6.

Recommended PC Board Hole Layout

Base Number (see note)	A Stack Height	B Tail Length	C Post Length	D Mating Length	B End Plating	D End Plating
146483	.200 [5.08]	.130 [3.30]	.440 [11.17]	.110 [2.79]	TIN	TIN
146484	.250 [6.35]	.080 [2.03]	.440 [11.17]	.110 [2.79]	TIN	TIN
146485	.250 [6.35]	.114 [2.89]	.474 [12.03]	.110 [2.79]	TIN	TIN
146486	.300 [7.62]	.123 [3.12]	.533 [13.53]	.110 [2.79]	TIN	TIN
146487	.400 [10.16]	.107 [2.71]	.617 [15.67]	.110 [2.79]	TIN	TIN
146488	.450 [11.43]	.057 [1.45]	.617 [15.67]	.110 [2.79]	TIN	TIN
146489	.500 [12.70]	.129 [3.27]	.739 [18.77]	.110 [2.79]	TIN	TIN
146490	.300 [7.62]	.109 [2.77]	.739 [18.77]	.330 [8.38]	TIN	15 AU
146491	.600 [15.24]	.107 [2.71]	.817 [20.75]	.110 [2.79]	TIN	TIN
146492	.400 [10.16]	.087 [2.20]	.817 [20.75]	.330 [8.38]	TIN	15 AU
146493	.700 [17.78]	.120 [3.05]	.930 [23.62]	.110 [2.79]	TIN	TIN
146494	.500 [12.70]	.100 [2.54]	.930 [23.62]	.330 [8.38]	TIN	15 AU
146495	.270 [6.86]	.330 [8.38]	.930 [23.62]	.330 [8.38]	15 AU	15 AU
146496	.800 [20.32]	.120 [3.05]	1.030 [26.16]	.110 [2.79]	TIN	TIN
146497	.600 [15.24]	.100 [2.54]	1.030 [26.16]	.330 [8.38]	TIN	15 AU
146498	.370 [9.39]	.330 [8.38]	1.030 [26.16]	.330 [8.38]	15 AU	15 AU
146499	.900 [22.86]	.120 [3.05]	1.130 [28.70]	.110 [2.79]	TIN	TIN
146500	.700 [17.78]	.100 [2.54]	1.130 [28.70]	.330 [8.38]	TIN	15 AU
146501	.470 [11.93]	.330 [8.38]	1.130 [28.70]	.330 [8.38]	15 AU	15 AU
146502	1.000 [25.40]	.120 [3.05]	1.230 [31.24]	.110 [2.79]	TIN	TIN
146503	.800 [20.32]	.100 [2.54]	1.230 [31.24]	.330 [8.38]	TIN	15 AU
146504	.570 [14.74]	.330 [8.38]	1.230 [31.24]	.330 [8.38]	15 AU	15 AU
146505	1.100 [27.94]	.120 [3.05]	1.330 [33.78]	.110 [2.79]	TIN	TIN
146506	.900 [22.86]	.100 [2.54]	1.330 [33.78]	.330 [8.38]	TIN	15 AU
146507	.670 [17.01]	.330 [8.38]	1.330 [33.78]	.330 [8.38]	15 AU	15 AU
146508	1.200 [30.48]	.120 [3.05]	1.430 [36.32]	.110 [2.79]	TIN	TIN
146509	1.000 [25.40]	.100 [2.54]	1.430 [36.32]	.330 [8.38]	TIN	15 AU
146510	.770 [19.55]	.330 [8.38]	1.430 [36.32]	.330 [8.38]	15 AU	15 AU

Note: All part numbers are RoHS compliant.

Standard Profile Headers—Shrouded

Product Facts

- Available in several styles—right-angle with three- and four-sided pin protection, and straight post with pin protection and mounting ears
- Post retention feature available
- Can be used for feed-to and feed-thru applications
- Housings are black thermoplastic, flame retardant 94V-0 rated
- Contacts are copper alloy
- Available in gold duplex, gold over nickel and tin over nickel platings
- Headers with .066 [1.68] and .150 [3.81] end dimensions are available in select sizes up to 60 positions
- Can be select loaded, consult Tyco Electronics
- Recognized under the Component Program of Underwriters Laboratories Inc. File No. E28476
- Certified by Canadian Standards Association, File No. LR 7189

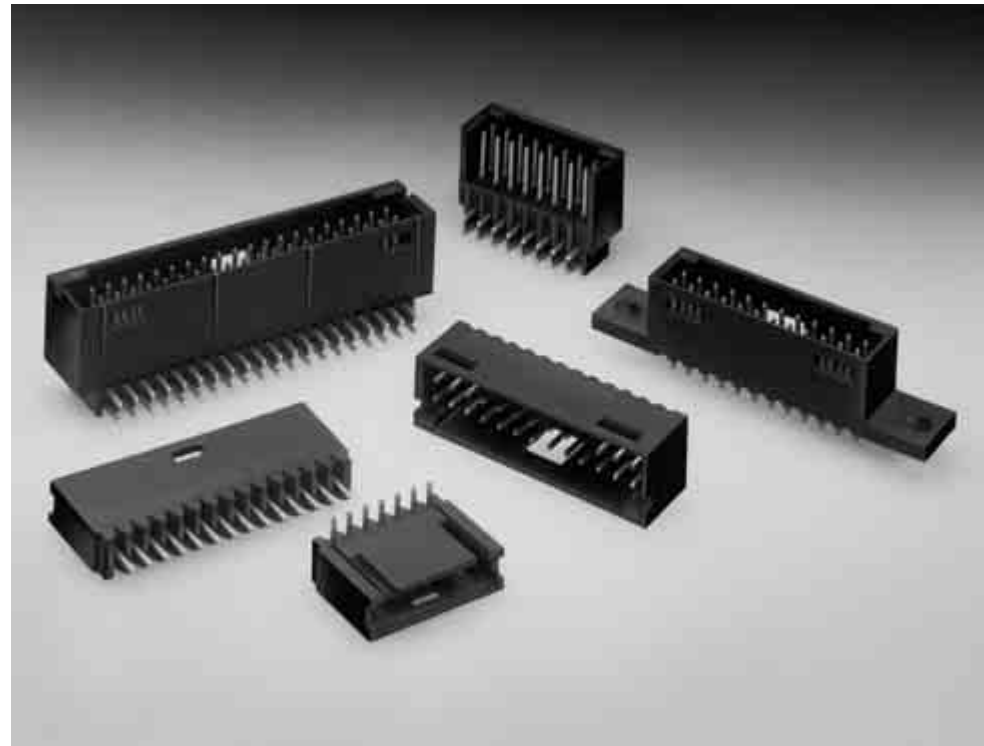

Performance Characteristics

Electrical

Insulation Resistance — 5,000 megohms minimum initial

Dielectric Withstanding Voltage — 750 RMS at sea level

Environmental

Operating Temperature — -65°C to +105°C (black thermoplastic housings)

Current — 3 amperes maximum per contact

Standard Profile Headers—Shrouded, Single-Row, .100 [2.54] Centerline

.025 [0.64] Square Straight Post (with Standoffs)



Material and Finish

Housing — Black thermoplastic, 94V-0 rated

Posts — Phosphor bronze, plated as follows:

Plating A — Duplex plated .000030 [0.00076] gold on contact area, .000100-.000200 [0.00254-0.00508] tin on solder area, with entire post under-plated .000050 [0.00127] nickel

Plating B — Duplex plated .000015 [0.00038] gold on contact area, .000100-.000200 [0.00254-0.00508] tin on solder area, with entire post under-plated .000050 [0.00127] nickel

Plating C — .000100-.000200 [0.00254-0.00508] tin over .000050 [0.00127] nickel on entire post

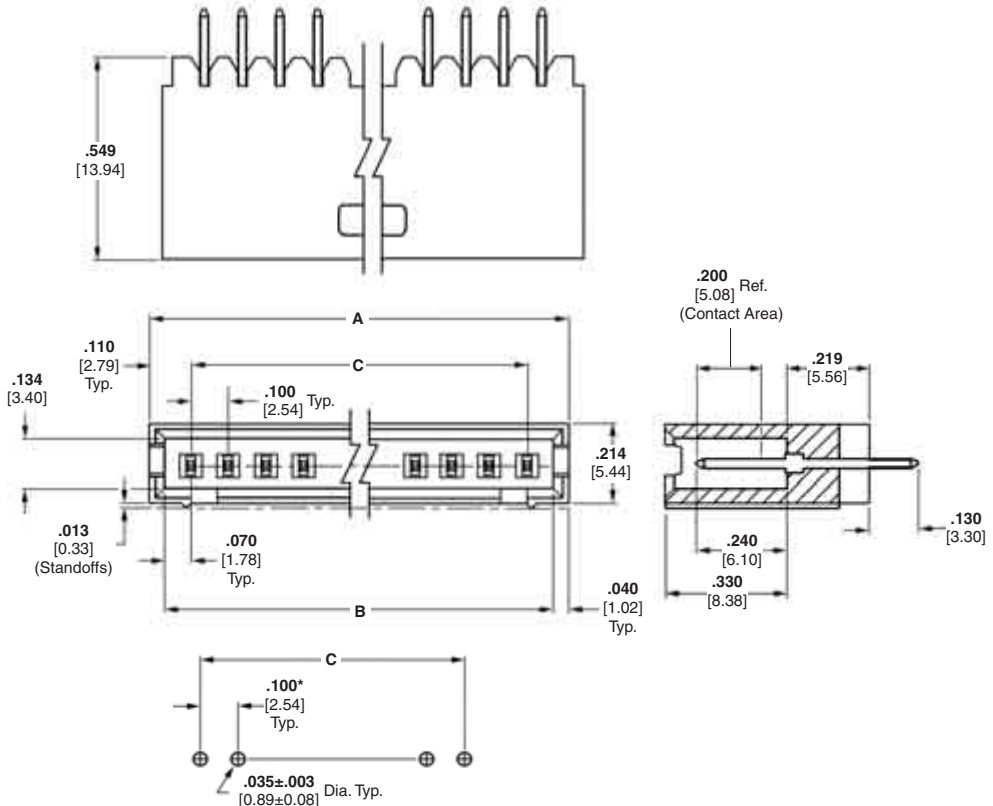

Recommended PC Board Hole Layout (for .055 [1.40] min. thick PC board)

*±.003 [±0.08] tolerances not to accumulate within one connector pattern.

Related Product Data

Mateable Connectors —

AMPMODU Wire-Applied Receptacles — page 215

AMPMODU MTE Receptacles — pages 228, 229, 234

Technical Documents — page 276

See mating connector for applicable product and application specifications.

No. of Pos.	Dimensions			Post Plating/Part Nos.		
	A	B	C	Plating A	Plating B	Plating C
3	.420 [10.67]	.340 [8.64]	.200 [5.08]	5-103414-1	8-102202-4	5-103080-1
4	.520 [13.21]	.440 [11.18]	.300 [7.62]	5-103414-2	5-102202-1	5-103080-2
5	.620 [15.75]	.540 [13.72]	.400 [10.16]	5-103414-3	5-102202-2	5-103080-3
6	.720 [18.29]	.640 [16.26]	.500 [12.70]	5-103414-4	5-102202-3	5-103080-4
7	.820 [20.83]	.740 [18.80]	.600 [15.24]	5-103414-5	5-102202-4	5-103080-5
8	.920 [23.37]	.840 [21.34]	.700 [17.78]	5-103414-6	5-102202-5	5-103080-6
9	1.020 [25.91]	.940 [23.88]	.800 [20.32]	5-103414-7	5-102202-6	5-103080-7
10	1.120 [28.45]	1.040 [26.42]	.900 [22.86]	5-103414-8	5-102202-7	5-103080-8
11	1.220 [30.99]	1.140 [28.96]	1.000 [25.40]	5-103414-9	5-102202-8	5-103080-9
12	1.320 [33.53]	1.240 [31.50]	1.100 [27.94]	6-103414-0	5-102202-9	6-103080-0
13	1.420 [36.07]	1.340 [34.04]	1.200 [30.48]	6-103414-1	6-102202-0	6-103080-1
14	1.520 [38.61]	1.440 [36.58]	1.300 [33.02]	6-103414-2	6-102202-1	6-103080-2
15	1.620 [41.15]	1.540 [39.12]	1.400 [35.56]	6-103414-3	6-102202-2	6-103080-3
16	1.720 [43.69]	1.640 [41.66]	1.500 [38.10]	6-103414-4	6-102202-3	6-103080-4
17	1.820 [46.23]	1.740 [44.20]	1.600 [40.64]	6-103414-5	6-102202-4	6-103080-5
18	1.920 [48.77]	1.840 [46.74]	1.700 [43.18]	6-103414-6	6-102202-5	6-103080-6
19	2.020 [51.31]	1.940 [49.28]	1.800 [45.72]	6-103414-7	6-102202-6	6-103080-7
20	2.120 [53.85]	2.040 [51.82]	1.900 [48.26]	6-103414-8	6-102202-7	6-103080-8
21	2.220 [56.39]	2.140 [54.36]	2.000 [50.80]	6-103414-9	6-102202-8	6-103080-9
22	2.320 [58.93]	2.240 [56.90]	2.100 [53.34]	7-103414-0	6-102202-9	7-103080-0
23	2.420 [61.47]	2.340 [59.44]	2.200 [55.88]	7-103414-1	7-102202-0	7-103080-1
24	2.520 [64.01]	2.440 [61.98]	2.300 [58.42]	7-103414-2	7-102202-1	7-103080-2
25	2.620 [66.55]	2.540 [64.52]	2.400 [60.96]	7-103414-3	7-102202-2	7-103080-3

Note: All part numbers are RoHS compliant.

**Standard Profile Headers—Shrouded, Single-Row,
.100 [2.54] Centerline** (Continued)

**.025 [0.64] Square
Right-Angle Post
(with Standoffs)**

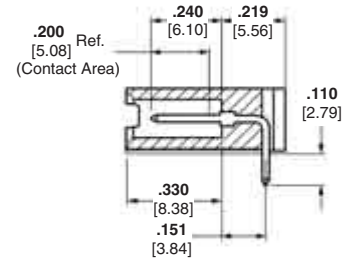
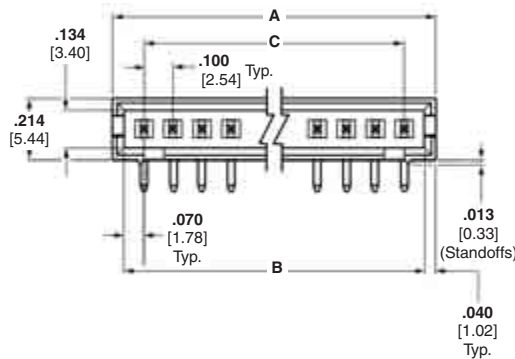
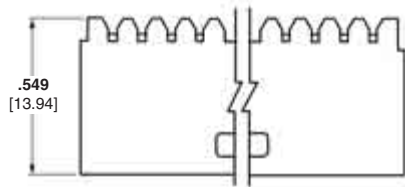

Material and Finish

Housing — Black thermoplastic, 94V-0 rated

Posts — Phosphor bronze, plated as follows:

Plating A — Duplex plated .000030 [0.00076] gold on contact area, .000100-.000200 [0.00254-0.00508] tin on solder area, with entire post underplated .000050 [0.00127] nickel

Plating B — Duplex plated .000015 [0.00038] gold on contact area, .000100-.000200 [0.00254-0.00508] tin on solder area, with entire post underplated .000050 [0.00127] nickel

Plating C — .000100-.000200 [0.00254-0.00508] tin over .000050 [0.00127] nickel on entire post

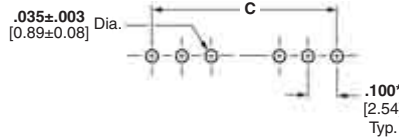

**Recommended PC Board Hole Layout
(for .055 [1.40] min. thick PC board)**

*±.003 [±0.08] tolerances not to accumulate within one connector pattern.

Related Product Data

Mateable Connectors —
AMPMODU Wire-Applied Receptacles — page 215

AMPMODU MTE Receptacles — pages 228, 229, 234

Technical Documents — page 276

See mating connector for applicable product and application specifications.

No. of Pos.	Dimensions			Post Plating/Part Nos.		
	A	B	C	Plating A	Plating B	Plating C
3	.420 [10.67]	.340 [8.64]	.200 [5.08]	5-103361-1	8-102203-4	5-102523-1
4	.520 [13.21]	.440 [11.18]	.300 [7.62]	5-103361-2	5-102203-1	5-102523-2
5	.620 [15.75]	.540 [13.72]	.400 [10.16]	5-103361-3	5-102203-2	5-102523-3
6	.720 [18.29]	.640 [16.26]	.500 [12.70]	5-103361-4	5-102203-3	5-102523-4
7	.820 [20.83]	.740 [18.80]	.600 [15.24]	5-103361-5	5-102203-4	5-102523-5
8	.920 [23.37]	.840 [21.34]	.700 [17.78]	5-103361-6	5-102203-5	5-102523-6
9	1.020 [25.91]	.940 [23.88]	.800 [20.32]	5-103361-7	5-102203-6	5-102523-7
10	1.120 [28.45]	1.040 [26.42]	.900 [22.86]	5-103361-8	5-102203-7	5-102523-8
11	1.220 [30.99]	1.140 [28.96]	1.000 [25.40]	5-103361-9	5-102203-8	5-102523-9
12	1.320 [33.53]	1.240 [31.50]	1.100 [27.94]	6-103361-0	5-102203-9	6-102523-0
13	1.420 [36.07]	1.340 [34.04]	1.200 [30.48]	6-103361-1	6-102203-0	6-102523-1
14	1.520 [38.61]	1.440 [36.58]	1.300 [33.02]	6-103361-2	6-102203-1	6-102523-2
15	1.620 [41.15]	1.540 [39.12]	1.400 [35.56]	6-103361-3	6-102203-2	6-102523-3
16	1.720 [43.69]	1.640 [41.66]	1.500 [38.10]	6-103361-4	6-102203-3	6-102523-4
17	1.820 [46.23]	1.740 [44.20]	1.600 [40.64]	6-103361-5	6-102203-4	6-102523-5
18	1.920 [48.77]	1.840 [46.74]	1.700 [43.18]	6-103361-6	6-102203-5	6-102523-6
19	2.020 [51.31]	1.940 [49.28]	1.800 [45.72]	6-103361-7	6-102203-6	6-102523-7
20	2.120 [53.85]	2.040 [51.82]	1.900 [48.26]	6-103361-8	6-102203-7	6-102523-8
21	2.220 [56.39]	2.140 [54.36]	2.000 [50.80]	6-103361-9	6-102203-8	6-102523-9
22	2.320 [58.93]	2.240 [56.90]	2.100 [53.34]	7-103361-0	6-102203-9	7-102523-0
23	2.420 [61.47]	2.340 [59.44]	2.200 [55.88]	7-103361-1	7-102203-0	7-102523-1
24	2.520 [64.01]	2.440 [61.98]	2.300 [58.42]	7-103361-2	7-102203-1	7-102523-2
25	2.620 [66.55]	2.540 [64.52]	2.400 [60.96]	7-103361-3	7-102203-2	7-102523-3

Note: All part numbers are RoHS compliant.

Standard Profile Headers—Shrouded, with .066 [1.68] End Dimension, Double-Row, .100 x .100 [2.54 x 2.54] Centerline

.025 [0.64] Square Straight Post (with Detent Windows)

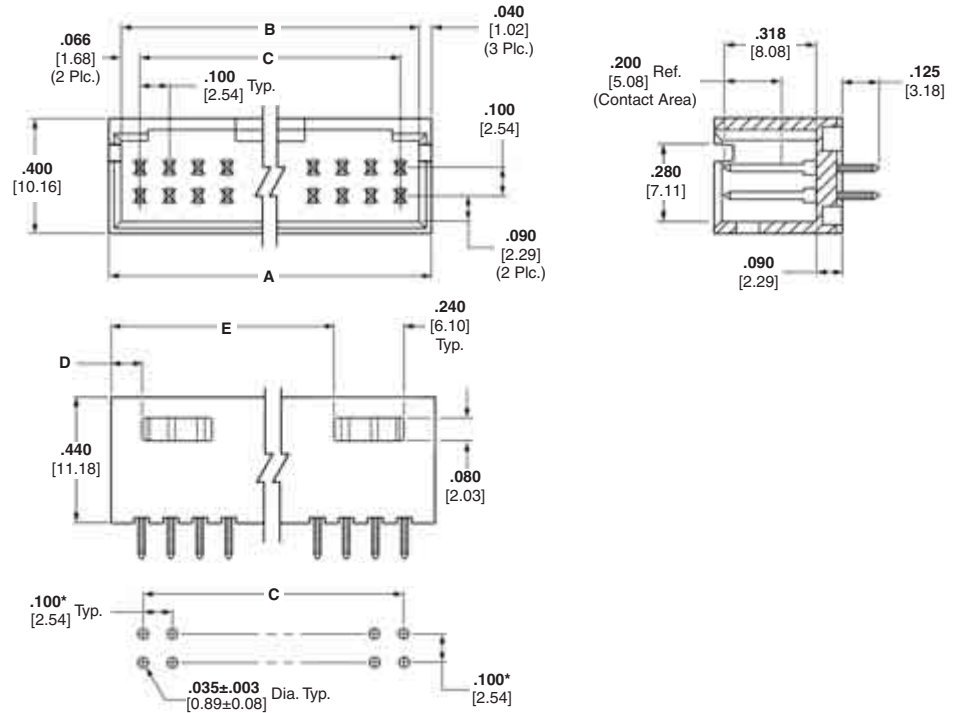

Recommended PC Board Hole Layout (for .055 [1.40] min. thick PC board)

*±.003 [±0.08] tolerances not to accumulate within one connector pattern.

Material and Finish

Housing — Black thermoplastic, 94V-0 rated

Posts — Phosphor bronze, plated as follows:

Plating A — Duplex plated .000030 [0.00076] gold on contact area, .000100-.000200 [0.00254-0.00508] tin on solder area, with entire post underplated .000050 [0.00127] nickel

Plating B — Duplex plated .000015 [0.00038] gold on contact area, .000100-.000200 [0.00254-0.00508] tin on solder area, with entire post underplated .000050 [0.00127] nickel

Plating C — .000100-.000200 [0.00254-0.00508] tin over .000050 [0.00127] nickel on entire post

Related Product Data

Mateable Connectors —

AMPMODU Board Mount Receptacles — pages 176, 179, 180

AMPMODU Wire-Applied Receptacles — pages 216-219

AMPMODU MTE Receptacles — pages 228, 229, 234

AMPMODU MT Receptacles — pages 256, 257

Accessories

Barrier Insert — page 204

Technical Documents — page 276

See mating connector for applicable product and application specifications.

No. of Pos.	Dimensions					Post Plating/Part Nos.		
	A	B	C	D	E	Plating A	Plating B	Plating C
6	.412 [10.46]	.332 [8.43]	.200 [5.08]	.106 [2.69]	—	5-103168-1	5-102618-1	8-87589-6
8	.512 [13.00]	.432 [10.97]	.300 [7.62]	.106 [2.69]	—	5-103168-2	5-102618-2	8-87589-5
10	.612 [15.54]	.532 [13.51]	.400 [10.16]	.206 [5.23]	—	5-103168-3	5-102618-3	5-87589-1
12	.712 [18.08]	.632 [16.05]	.500 [12.70]	.206 [5.23]	—	5-103168-4	5-102618-4	5-87589-2
14	.812 [20.62]	.732 [18.59]	.600 [15.24]	.306 [7.77]	—	5-103168-5	5-102618-5	5-87589-3
16	.912 [23.16]	.832 [21.13]	.700 [17.78]	.306 [7.77]	—	5-103168-6	5-102618-6	5-87589-4
18	1.012 [25.70]	.932 [23.67]	.800 [20.32]	.406 [10.31]	—	5-103168-7	5-102618-7	5-87589-5
20	1.112 [28.24]	1.032 [26.21]	.900 [22.86]	.106 [2.69]	.806 [20.47]	5-103168-8	5-102618-8	5-87589-6
22	1.212 [30.78]	1.132 [28.75]	1.000 [25.40]	.106 [2.69]	.906 [23.01]	5-103168-9	5-102618-9	5-87589-7
24	1.312 [33.32]	1.232 [31.29]	1.100 [27.94]	.106 [2.69]	1.006 [25.55]	6-103168-0	6-102618-0	5-87589-8
26	1.412 [35.86]	1.332 [33.83]	1.200 [30.48]	.106 [2.69]	1.106 [28.09]	6-103168-1	6-102618-1	5-87589-9
28	1.512 [38.40]	1.432 [36.37]	1.300 [33.02]	.106 [2.69]	1.206 [30.63]	6-103168-2	6-102618-2	6-87589-0
30	1.612 [40.94]	1.532 [38.91]	1.400 [35.56]	.106 [2.69]	1.306 [33.17]	6-103168-3	6-102618-3	6-87589-1

Note: All part numbers are RoHS compliant.

Standard Profile Headers—Shrouded, with .066 [1.68] End Dimension, Double-Row, .100 x .100 [2.54 x 2.54] Centerline (Continued)

No. of Positions	Dimensions					Post Plating/Part Nos.		
	A	B	C	D	E	Plating A	Plating B	Plating C
32	1.712 [43.48]	1.632 [41.45]	1.500 [38.10]	.106 [2.69]	1.406 [35.71]	6-103168-4	6-102618-4	6-87589-2
34	1.812 [46.02]	1.732 [43.99]	1.600 [40.64]	.106 [2.69]	1.506 [38.25]	6-103168-5	6-102618-5	6-87589-3
36	1.912 [48.56]	1.832 [46.53]	1.700 [43.18]	.106 [2.69]	1.606 [40.79]	6-103168-6	6-102618-6	6-87589-4
38	2.012 [51.10]	1.932 [49.07]	1.800 [45.72]	.106 [2.69]	1.706 [43.33]	6-103168-7	6-102618-7	6-87589-5
40	2.112 [53.64]	2.032 [51.61]	1.900 [48.26]	.106 [2.69]	1.806 [45.87]	6-103168-8	6-102618-8	6-87589-6
42	2.212 [56.18]	2.132 [54.15]	2.000 [50.80]	.106 [2.69]	1.906 [48.41]	6-103168-9	6-102618-9	6-87589-7
44	2.312 [58.72]	2.232 [56.69]	2.100 [53.34]	.106 [2.69]	2.006 [50.95]	7-103168-0	7-102618-0	6-87589-8
46	2.412 [61.26]	2.332 [59.23]	2.200 [55.88]	.106 [2.69]	2.106 [53.49]	7-103168-1	7-102618-1	6-87589-9
48	2.512 [63.80]	2.432 [61.77]	2.300 [58.42]	.106 [2.69]	2.206 [56.03]	7-103168-2	7-102618-2	7-87589-0
50	2.612 [66.34]	2.532 [64.31]	2.400 [60.96]	.106 [2.69]	2.306 [58.57]	7-103168-3	7-102618-3	7-87589-1
52	2.712 [68.88]	2.632 [66.85]	2.500 [63.50]	.106 [2.69]	2.406 [61.11]	7-103168-4	7-102618-4	7-87589-2
54	2.812 [71.42]	2.732 [69.39]	2.600 [66.04]	.106 [2.69]	2.506 [63.65]	7-103168-5	7-102618-5	7-87589-3
56	2.912 [73.96]	2.832 [71.93]	2.700 [68.58]	.106 [2.69]	2.606 [66.19]	7-103168-6	7-102618-6	7-87589-4
58	3.012 [76.50]	2.932 [74.47]	2.800 [71.12]	.106 [2.69]	2.706 [68.73]	7-103168-7	7-102618-7	7-87589-5
60	3.112 [79.04]	3.032 [77.01]	2.900 [73.66]	.106 [2.69]	2.806 [71.27]	7-103168-8	7-102618-8	7-87589-6
62	3.212 [81.58]	3.132 [79.55]	3.000 [76.20]	.106 [2.69]	2.906 [73.81]	7-103168-9	7-102618-9	7-87589-7
64	3.312 [84.12]	3.232 [82.09]	3.100 [78.74]	.106 [2.69]	3.006 [76.35]	8-103168-0	8-102618-0	7-87589-8
66	3.412 [86.66]	3.332 [84.63]	3.200 [81.28]	.106 [2.69]	3.106 [78.89]	8-103168-1	8-102618-1	7-87589-9
68	3.512 [89.20]	3.432 [87.17]	3.300 [83.82]	.106 [2.69]	3.206 [81.43]	8-103168-2	8-102618-2	8-87589-0
70	3.612 [91.74]	3.532 [89.71]	3.400 [86.36]	.106 [2.69]	3.306 [83.97]	8-103168-3	8-102618-3	8-87589-1
72	3.712 [94.28]	3.632 [92.25]	3.500 [88.90]	.106 [2.69]	3.406 [86.51]	8-103168-4	8-102618-4	8-87589-2
74	3.812 [96.82]	3.732 [94.79]	3.600 [91.44]	.106 [2.69]	3.506 [89.05]	8-103168-5	8-102618-5	8-87589-3

Note: All part numbers are RoHS compliant.

Standard Profile Headers—Shrouded, with .150 [3.81] End Dimension, Double-Row, .100 x .100 [2.54 x 2.54] Centerline

.025 [0.64] Square Straight Post (with Detent Windows)



Material and Finish

Housing — Black thermoplastic, 94V-0 rated

Posts — Phosphor bronze, plated as follows:

Plating A — Duplex plated .000030 [0.00076] gold on contact area, .000100-.000200 [0.00254-0.00508] tin on solder area, with entire post underplated .000050 [0.00127] nickel

Plating B — Duplex plated .000015 [0.00038] gold on contact area, .000100-.000200 [0.00254-0.00508] tin on solder area, with entire post underplated .000050 [0.00127] nickel

Plating C — .000100-.000200 [0.00254-0.00508] tin over .000050 [0.00127] nickel on entire post

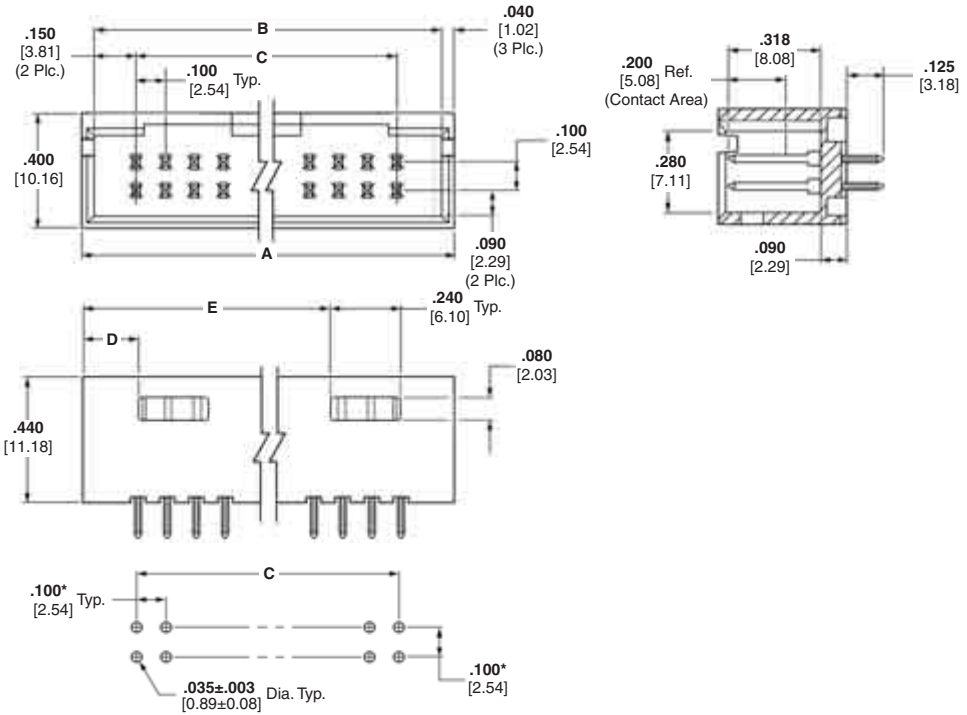

Recommended PC Board Hole Layout (for .055 [1.40] min. thick PC board)

*±.003 [±0.08] tolerances not to accumulate within one connector pattern.

Related Product Data

Mateable Connectors

AMPMODU MTE Receptacles — pages 232, 233, 235 (used with coupling shroud on page 241)

AMPMODU Wire-Applied Receptacles — pages 216-219

Accessories

Barrier Insert — page 204

Technical Documents — page 276

See mating connector for applicable product and application specifications.

No. of Pos.	Dimensions					Post Plating/Part Nos.		
	A	B	C	D	E	Plating A	Plating B	Plating C
6	.580 [14.73]	.500 [12.70]	.200 [5.08]	.190 [4.83]	—	5-103169-1	5-102619-1	8-87587-3
8	.680 [17.27]	.600 [15.24]	.300 [7.62]	.190 [4.83]	—	5-103169-2	5-102619-2	8-87587-4
10	.780 [19.81]	.700 [17.78]	.400 [10.16]	.290 [7.37]	—	5-103169-3	5-102619-3	5-87587-1
12	.880 [22.35]	.800 [20.32]	.500 [12.70]	.290 [7.37]	—	5-103169-4	5-102619-4	5-87587-2
14	.980 [24.89]	.900 [22.86]	.600 [15.24]	.390 [9.91]	—	5-103169-5	5-102619-5	5-87587-3
16	1.080 [27.43]	1.000 [25.40]	.700 [17.78]	.390 [9.91]	—	5-103169-6	5-102619-6	5-87587-4
18	1.180 [29.97]	1.100 [27.94]	.800 [20.32]	.490 [12.45]	—	5-103169-7	5-102619-7	5-87587-5
20	1.280 [32.51]	1.200 [30.48]	.900 [22.86]	.190 [4.83]	.890 [22.61]	5-103169-8	5-102619-8	5-87587-6
22	1.380 [35.05]	1.300 [33.02]	1.000 [25.40]	.190 [4.83]	.990 [25.15]	5-103169-9	5-102619-9	5-87587-7
24	1.480 [37.59]	1.400 [35.56]	1.100 [27.94]	.190 [4.83]	1.090 [27.69]	6-103169-0	6-102619-0	5-87587-8
26	1.580 [40.13]	1.500 [38.10]	1.200 [30.48]	.190 [4.83]	1.190 [30.23]	6-103169-1	6-102619-1	5-87587-9
28	1.680 [42.67]	1.600 [40.64]	1.300 [33.02]	.190 [4.83]	1.290 [32.77]	6-103169-2	6-102619-2	6-87587-0
30	1.780 [45.21]	1.700 [43.18]	1.400 [35.56]	.190 [4.83]	1.390 [35.31]	6-103169-3	6-102619-3	6-87587-1

Note: All part numbers are RoHS compliant.

Standard Profile Headers—Shrouded, with .150 [3.81] End Dimension, Double-Row, .100 x .100 [2.54 x 2.54] Centerline (Continued)

No. of Pos.	Dimensions					Post Plating/Part Nos.		
	A	B	C	D	E	Plating A	Plating B	Plating C
32	1.880 [47.75]	1.800 [45.72]	1.500 [38.10]	.190 [4.83]	1.490 [37.85]	6-103169-4	6-102619-4	6-87587-2
34	1.980 [50.29]	1.900 [48.26]	1.600 [40.64]	.190 [4.83]	1.590 [40.39]	6-103169-5	6-102619-5	6-87587-3
36	2.080 [52.83]	2.000 [50.80]	1.700 [43.18]	.190 [4.83]	1.690 [42.93]	6-103169-6	6-102619-6	6-87587-4
38	2.180 [55.37]	2.100 [53.34]	1.800 [45.72]	.190 [4.83]	1.790 [45.47]	6-103169-7	6-102619-7	6-87587-5
40	2.280 [57.91]	2.200 [55.88]	1.900 [48.26]	.190 [4.83]	1.890 [48.01]	6-103169-8	6-102619-8	6-87587-6
42	2.380 [60.45]	2.300 [58.42]	2.000 [50.80]	.190 [4.83]	1.990 [50.55]	6-103169-9	6-102619-9	6-87587-7
44	2.480 [62.99]	2.400 [60.96]	2.100 [53.34]	.190 [4.83]	2.090 [53.09]	7-103169-0	7-102619-0	6-87587-8
46	2.580 [65.53]	2.500 [63.50]	2.200 [55.88]	.190 [4.83]	2.190 [55.63]	7-103169-1	7-102619-1	6-87587-9
48	2.680 [68.07]	2.600 [66.04]	2.300 [58.42]	.190 [4.83]	2.290 [58.17]	7-103169-2	7-102619-2	7-87587-0
50	2.780 [70.61]	2.700 [68.58]	2.400 [60.96]	.190 [4.83]	2.390 [60.71]	7-103169-3	7-102619-3	7-87587-1
52	2.880 [73.15]	2.800 [71.12]	2.500 [63.50]	.190 [4.83]	2.490 [63.25]	7-103169-4	7-102619-4	7-87587-2
54	2.980 [75.69]	2.900 [73.66]	2.600 [66.04]	.190 [4.83]	2.590 [65.79]	7-103169-5	7-102619-5	7-87587-3
56	3.080 [78.23]	3.000 [76.20]	2.700 [68.58]	.190 [4.83]	2.690 [68.33]	7-103169-6	7-102619-6	7-87587-4
58	3.180 [80.77]	3.100 [78.74]	2.800 [71.12]	.190 [4.83]	2.790 [70.87]	7-103169-7	7-102619-7	7-87587-5
60	3.280 [83.31]	3.200 [81.28]	2.900 [73.66]	.190 [4.83]	2.890 [73.41]	7-103169-8	7-102619-8	7-87587-6
62	3.380 [85.85]	3.300 [83.82]	3.000 [76.20]	.190 [4.83]	2.990 [75.95]	7-103169-9	7-102619-9	7-87587-7
64	3.480 [88.39]	3.400 [86.36]	3.100 [78.74]	.190 [4.83]	3.090 [78.49]	8-103169-0	8-102619-0	7-87587-8
66	3.580 [90.93]	3.500 [88.90]	3.200 [81.28]	.190 [4.83]	3.190 [81.03]	8-103169-1	8-102619-1	7-87587-9
68	3.680 [93.47]	3.600 [91.44]	3.300 [83.82]	.190 [4.83]	3.290 [83.57]	8-103169-2	8-102619-2	8-87587-0
70	3.780 [96.01]	3.700 [93.98]	3.400 [86.36]	.190 [4.83]	3.390 [86.11]	8-103169-3	8-102619-3	8-87587-1
72	3.880 [98.55]	3.800 [96.52]	3.500 [88.90]	.190 [4.83]	3.490 [88.65]	8-103169-4	8-102619-4	8-87587-2

Note: All part numbers are RoHS compliant.

Standard Profile Headers—Shrouded, with .150 [3.81] End Dimension, Double-Row, .100 x .100 [2.54 x 2.54] Centerline (Continued)

.025 [0.64] Square Straight Post (with Plastic Holddowns)

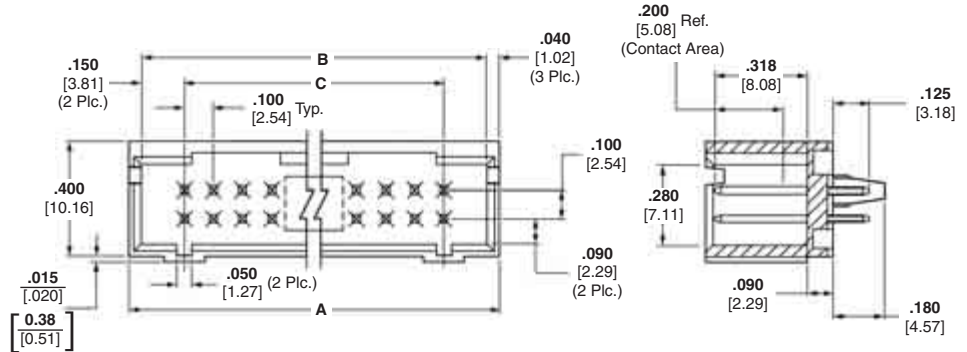

Material and Finish

Housing — Black thermoplastic, 94V-0 rated

Posts — Phosphor bronze, duplex plated .000015 [0.00038] gold on contact area, .000100-.000200 [0.00254-0.00508] tin on solder area, with entire post underplated .000050 [0.00127] nickel

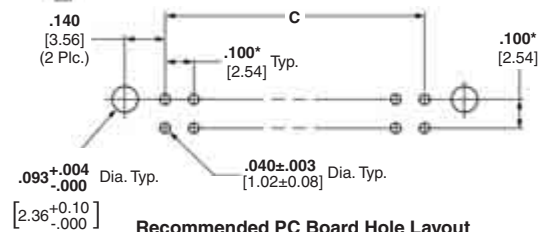
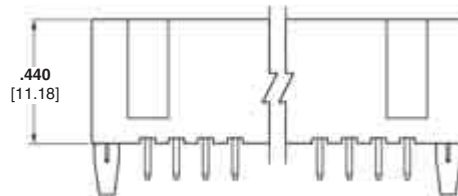

Recommended PC Board Hole Layout (for .055 [1.40] min. thick PC board)

*±.003 [±0.08] tolerances not to accumulate within one connector pattern.

Related Product Data

Mateable Connectors

AMPMODU MTE Receptacles — pages 232, 233, 235 (used with coupling shroud on page 241)

AMPMODU Wire-Applied Receptacles — pages 216-219

Accessories

Barrier Insert — page 204

Technical Documents — page 276

See mating connector for applicable product and application specifications.

No. of Pos.	Dimensions			Part Nos. Plating A
	A	B	C	
6	.580 [14.73]	.500 [12.70]	.200 [5.08]	5-104317-1
10	.780 [19.81]	.700 [17.78]	.400 [10.16]	5-104317-2
12	.880 [22.35]	.800 [20.32]	.500 [12.70]	5-104317-3
14	.980 [24.89]	.900 [22.86]	.600 [15.24]	5-104317-4
16	1.080 [27.43]	1.000 [25.40]	.700 [17.78]	6-104317-6
18	1.180 [29.97]	1.100 [27.94]	.800 [20.32]	5-104317-5
20	1.280 [32.51]	1.200 [30.48]	.900 [22.86]	5-104317-6
22	1.380 [35.05]	1.300 [33.02]	1.000 [25.40]	5-104317-7
24	1.480 [37.59]	1.400 [35.56]	1.100 [27.94]	5-104317-8
26	1.580 [40.13]	1.500 [38.10]	1.200 [30.48]	5-104317-9
30	1.780 [45.21]	1.700 [43.18]	1.400 [35.56]	6-104317-0
32	1.880 [47.75]	1.800 [45.72]	1.500 [38.10]	6-104317-1
34	1.980 [50.29]	1.900 [48.26]	1.600 [40.64]	6-104317-8
36	2.080 [52.83]	2.000 [50.80]	1.700 [43.18]	6-104317-7
40	2.280 [57.91]	2.200 [55.88]	1.900 [48.26]	6-104317-2
42	2.380 [60.45]	2.300 [58.42]	2.000 [50.80]	6-104317-5
48	2.680 [68.07]	2.600 [66.04]	2.300 [58.42]	6-104317-3
50	2.780 [70.61]	2.700 [68.58]	2.400 [60.96]	6-104317-4

Note: All part numbers are RoHS compliant.

Standard Profile Headers—Shrouded, with .066 [1.68] End Dimension, Double-Row, .100 x .100 [2.54 x 2.54] Centerline

.025 [0.64] Square Right-Angle Post (with Detent Windows)

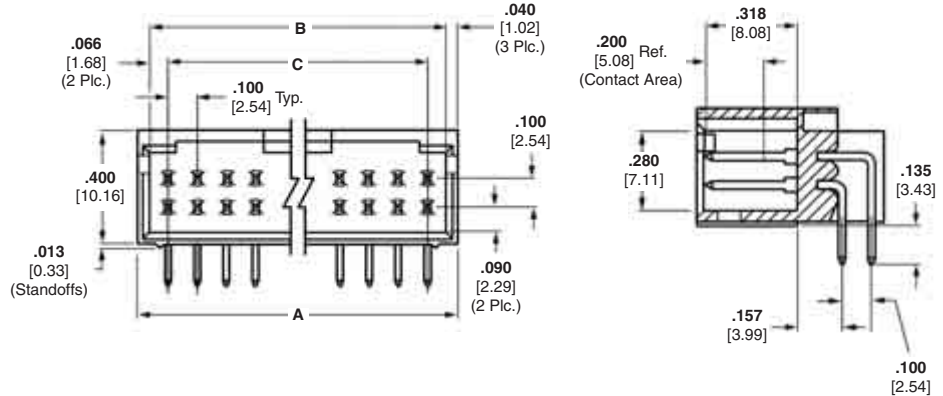

Material and Finish

Housing — Black thermoplastic, 94V-0 rated

Posts — Phosphor bronze, plated as follows:

Plating A — Duplex plated .000030 [0.00076] gold on contact area, .000100-.000200 [0.00254-0.00508] tin on solder area, with entire post underplated .000050 [0.00127] nickel

Plating B — Duplex plated .000015 [0.00038] gold on contact area, .000100-.000200 [0.00254-0.00508] tin on solder area, with entire post underplated .000050 [0.00127] nickel

Plating C — .000100-.000200 [0.00254-0.00508] tin over .000050 [0.00127] nickel on entire post

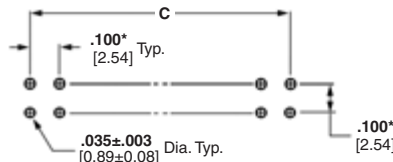
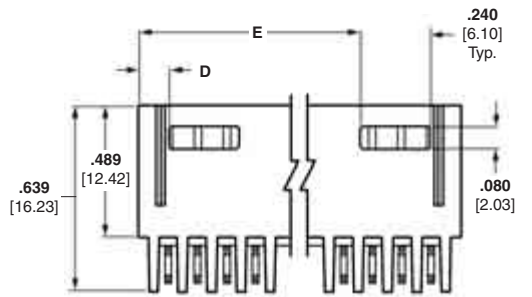

Recommended PC Board Hole Layout (for .055 [1.40] min. thick PC board)

*±.003 [±0.08] tolerances not to accumulate within one connector pattern.

Related Product Data

Mateable Connectors

AMPMODU Board Mount Receptacles — pages 176, 179, 180

AMPMODU Wire-Applied Receptacles — pages 216-219

AMPMODU MTE Receptacles — pages 228, 229, 234

AMPMODU MT Receptacles — pages 256, 257

Technical Documents — page 276

See mating connector for applicable product and application specifications.

No. of Pos.	Dimensions					Post Plating/Part Nos.		
	A	B	C	D	E	Plating A	Plating B	Plating C
6	.412 [10.46]	.332 [8.43]	.200 [5.08]	.106 [2.69]	—	5-103166-1	5-102617-1	8-87579-5
8	.512 [13.00]	.432 [10.97]	.300 [7.62]	.106 [2.69]	—	5-103166-2	5-102617-2	5-87579-1
10	.612 [15.54]	.532 [13.51]	.400 [10.16]	.206 [5.23]	—	5-103166-3	5-102617-3	5-87579-2
12	.712 [18.08]	.632 [16.05]	.500 [12.70]	.206 [5.23]	—	5-103166-4	5-102617-4	5-87579-3
14	.812 [20.62]	.732 [18.59]	.600 [15.24]	.306 [7.77]	—	5-103166-5	5-102617-5	5-87579-4
16	.912 [23.16]	.832 [21.13]	.700 [17.78]	.306 [7.77]	—	5-103166-6	5-102617-6	5-87579-5
18	1.012 [25.70]	.932 [23.67]	.800 [20.32]	.406 [10.31]	—	5-103166-7	5-102617-7	5-87579-6
20	1.112 [28.24]	1.032 [26.21]	.900 [22.86]	.106 [2.69]	.806 [20.47]	5-103166-8	5-102617-8	5-87579-7
22	1.212 [30.78]	1.132 [28.75]	1.000 [25.40]	.106 [2.69]	.906 [23.01]	5-103166-9	5-102617-9	5-87579-8
24	1.312 [33.32]	1.232 [31.29]	1.100 [27.94]	.106 [2.69]	1.006 [25.55]	6-103166-0	6-102617-0	5-87579-9
26	1.412 [35.86]	1.332 [33.83]	1.200 [30.48]	.106 [2.69]	1.106 [28.09]	6-103166-1	6-102617-1	6-87579-0
28	1.512 [38.40]	1.432 [36.37]	1.300 [33.02]	.106 [2.69]	1.206 [30.63]	6-103166-2	6-102617-2	6-87579-1
30	1.612 [40.94]	1.532 [38.91]	1.400 [35.56]	.106 [2.69]	1.306 [33.17]	6-103166-3	6-102617-3	6-87579-2

Note: All part numbers are RoHS compliant.

Standard Profile Headers, Shrouded

5

Standard Profile Headers—Shrouded, with .066 [1.68] End Dimension, Double-Row, .100 x .100 [2.54 x 2.54] Centerline (Continued)

No. of Pos.	Dimensions					Post Plating/Part Nos.		
	A	B	C	D	E	Plating A	Plating B	Plating C
32	1.712 [43.48]	1.632 [41.45]	1.500 [38.10]	.106 [2.69]	1.406 [35.71]	6-103166-4	6-102617-4	6-87579-3
34	1.812 [46.02]	1.732 [43.99]	1.600 [40.64]	.106 [2.69]	1.506 [38.25]	6-103166-5	6-102617-5	6-87579-4
36	1.912 [48.56]	1.832 [46.53]	1.700 [43.18]	.106 [2.69]	1.606 [40.79]	6-103166-6	6-102617-6	6-87579-5
38	2.012 [51.10]	1.932 [49.07]	1.800 [45.72]	.106 [2.69]	1.706 [43.33]	6-103166-7	6-102617-7	6-87579-6
40	2.112 [53.64]	2.032 [51.61]	1.900 [48.26]	.106 [2.69]	1.806 [45.87]	6-103166-8	6-102617-8	6-87579-7
42	2.212 [56.18]	2.132 [54.15]	2.000 [50.80]	.106 [2.69]	1.906 [48.41]	6-103166-9	6-102617-9	6-87579-8
44	2.312 [58.72]	2.232 [56.69]	2.100 [53.34]	.106 [2.69]	2.006 [50.95]	7-103166-0	7-102617-0	6-87579-9
46	2.412 [61.26]	2.332 [59.23]	2.200 [55.88]	.106 [2.69]	2.106 [53.49]	7-103166-1	7-102617-1	7-87579-0
48	2.512 [63.80]	2.432 [61.77]	2.300 [58.42]	.106 [2.69]	2.206 [56.03]	7-103166-2	7-102617-2	7-87579-1
50	2.612 [66.34]	2.532 [64.31]	2.400 [60.96]	.106 [2.69]	2.306 [58.57]	7-103166-3	7-102617-3	7-87579-2
52	2.712 [68.88]	2.632 [66.85]	2.500 [63.50]	.106 [2.69]	2.406 [61.11]	7-103166-4	7-102617-4	7-87579-3
54	2.812 [71.42]	2.732 [69.39]	2.600 [66.04]	.106 [2.69]	2.506 [63.65]	7-103166-5	7-102617-5	7-87579-4
56	2.912 [73.96]	2.832 [71.93]	2.700 [68.58]	.106 [2.69]	2.606 [66.19]	7-103166-6	7-102617-6	7-87579-5
58	3.012 [76.50]	2.932 [74.47]	2.800 [71.12]	.106 [2.69]	2.706 [68.73]	7-103166-7	7-102617-7	7-87579-6
60	3.112 [79.04]	3.032 [77.01]	2.900 [73.66]	.106 [2.69]	2.806 [71.27]	7-103166-8	7-102617-8	7-87579-7
62	3.212 [81.58]	3.132 [79.55]	3.000 [76.20]	.106 [2.69]	2.906 [73.81]	7-103166-9	7-102617-9	7-87579-8
64	3.312 [84.12]	3.232 [82.09]	3.100 [78.74]	.106 [2.69]	3.006 [76.35]	8-103166-0	8-102617-0	7-87579-9
66	3.412 [86.66]	3.332 [84.63]	3.200 [81.28]	.106 [2.69]	3.106 [78.89]	8-103166-1	8-102617-1	8-87579-0
68	3.512 [89.20]	3.432 [87.17]	3.300 [83.82]	.106 [2.69]	3.206 [81.43]	8-103166-2	8-102617-2	8-87579-1
70	3.612 [91.74]	3.532 [89.71]	3.400 [86.36]	.106 [2.69]	3.306 [83.97]	8-103166-3	8-102617-3	8-87579-2
72	3.712 [94.28]	3.632 [92.25]	3.500 [88.90]	.106 [2.69]	3.406 [86.51]	8-103166-4	8-102617-4	8-87579-3
74	3.812 [96.82]	3.732 [94.79]	3.600 [91.44]	.106 [2.69]	3.506 [89.05]	8-103166-5	8-102617-5	8-87579-4

 Standard Profile Headers,
Shrouded

5

Note: All part numbers are RoHS compliant.

Standard Profile Headers—Shrouded, with .150 [3.81] End Dimension, Double-Row, .100 x .100 [2.54 x 2.54] Centerline

.025 [0.64] Square Right-Angle Post (with Detent Windows)

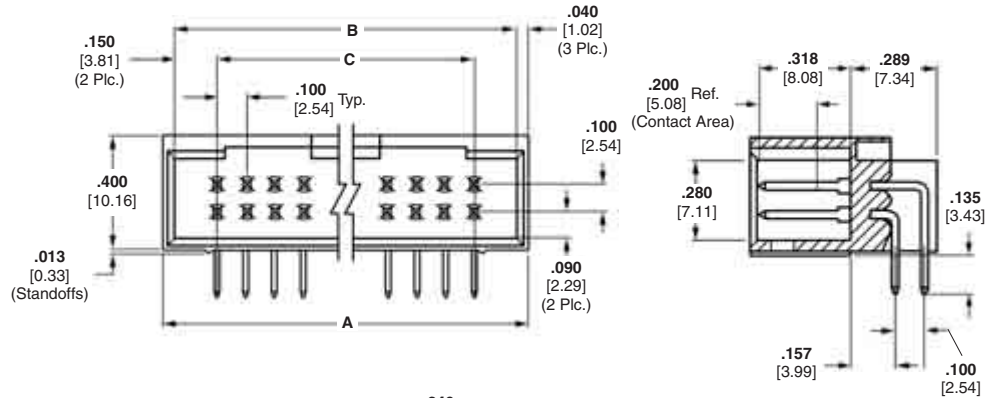

Material and Finish

Housing — Black thermoplastic, 94V-0 rated

Posts — Phosphor bronze, plated as follows:

Plating A — Duplex plated .000030 [0.00076] gold on contact area, .000100-.000200 [0.00254-0.00508] tin on solder area, with entire post underplated .000050 [0.00127] nickel

Plating B — Duplex plated .000015 [0.00038] gold on contact area, .000100-.000200 [0.00254-0.00508] tin on solder area, with entire post underplated .000050 [0.00127] nickel

Plating C — .000100-.000200 [0.00254-0.00508] tin over .000050 [0.00127] nickel on entire post

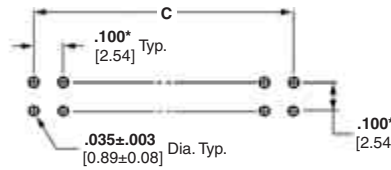
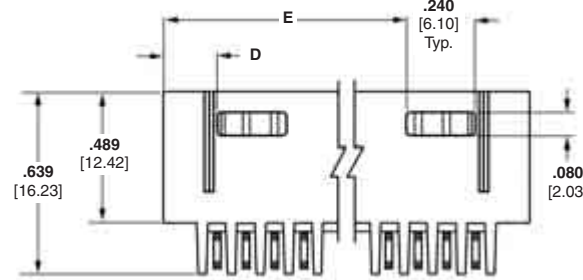

Recommended PC Board Hole Layout (for .055 [1.40] min. thick PC board)

*±.003 [±0.08] tolerances not to accumulate within one connector pattern.

Related Product Data

Mateable Connectors

AMPMODU MTE Receptacles — pages 232, 233, 235 (used with coupling shroud on page 241)

AMPMODU Wire-Applied Receptacles — pages 216-219

Technical Documents — page 276

See mating connector for applicable product and application specifications.

No. of Pos.	Dimensions					Post Plating/Part Nos.		
	A	B	C	D	E	Plating A	Plating B	Plating C
8	.680 [17.27]	.600 [15.24]	.300 [7.62]	.190 [4.83]	—	5-103167-1	5-102570-2	5-87577-1
10	.780 [19.81]	.700 [17.78]	.400 [10.16]	.290 [7.37]	—	5-103167-2	5-102570-3	5-87577-2
12	.880 [22.35]	.800 [20.32]	.500 [12.70]	.290 [7.37]	—	5-103167-3	5-102570-4	5-87577-3
14	.980 [24.89]	.900 [22.86]	.600 [15.24]	.390 [9.91]	—	5-103167-4	5-102570-5	5-87577-4
16	1.080 [27.43]	1.000 [25.40]	.700 [17.78]	.390 [9.91]	—	5-103167-5	5-102570-6	5-87577-5
18	1.180 [29.97]	1.100 [27.94]	.800 [20.32]	.490 [12.45]	—	5-103167-6	5-102570-7	5-87577-6
20	1.280 [32.51]	1.200 [30.48]	.900 [22.86]	.190 [4.83]	.890 [22.61]	5-103167-7	5-102570-8	5-87577-7
22	1.380 [35.05]	1.300 [33.02]	1.000 [25.40]	.190 [4.83]	.990 [25.15]	5-103167-8	5-102570-9	5-87577-8
24	1.480 [37.59]	1.400 [35.56]	1.100 [27.94]	.190 [4.83]	1.090 [27.69]	5-103167-9	6-102570-0	5-87577-9
26	1.580 [40.13]	1.500 [38.10]	1.200 [30.48]	.190 [4.83]	1.190 [30.23]	6-103167-0	6-102570-1	6-87577-0
28	1.680 [42.67]	1.600 [40.64]	1.300 [33.02]	.190 [4.83]	1.290 [32.77]	6-103167-1	6-102570-2	6-87577-1
30	1.780 [45.21]	1.700 [43.18]	1.400 [35.56]	.190 [4.83]	1.390 [35.31]	6-103167-2	6-102570-3	6-87577-2

Note: All part numbers are RoHS compliant.

Standard Profile Headers, Shrouded

5

Standard Profile Headers—Shrouded, with .150 [3.81] End Dimension, Double-Row, .100 x .100 [2.54 x 2.54] Centerline (Continued)

No. of Pos.	Dimensions					Post Plating/Part Nos.		
	A	B	C	D	E	Plating A	Plating B	Plating C
32	1.880 [47.75]	1.800 [45.72]	1.500 [38.10]	.190 [4.83]	1.490 [37.85]	6-103167-3	6-102570-4	6-87577-3
34	1.980 [50.29]	1.900 [48.26]	1.600 [40.64]	.190 [4.83]	1.590 [40.39]	6-103167-4	6-102570-5	6-87577-4
36	2.080 [52.83]	2.000 [50.80]	1.700 [43.18]	.190 [4.83]	1.690 [42.93]	6-103167-5	6-102570-6	6-87577-5
38	2.180 [55.37]	2.100 [53.34]	1.800 [45.72]	.190 [4.83]	1.790 [45.47]	6-103167-6	6-102570-7	6-87577-6
40	2.280 [57.91]	2.200 [55.88]	1.900 [48.26]	.190 [4.83]	1.890 [48.01]	6-103167-7	5-102570-1	6-87577-7
42	2.380 [60.45]	2.300 [58.42]	2.000 [50.80]	.190 [4.83]	1.990 [50.55]	6-103167-8	6-102570-8	6-87577-8
44	2.480 [62.99]	2.400 [60.96]	2.100 [53.34]	.190 [4.83]	2.090 [53.09]	6-103167-9	6-102570-9	6-87577-9
46	2.580 [65.53]	2.500 [63.50]	2.200 [55.88]	.190 [4.83]	2.190 [55.63]	7-103167-0	7-102570-0	7-87577-0
48	2.680 [68.07]	2.600 [66.04]	2.300 [58.42]	.190 [4.83]	2.290 [58.17]	7-103167-1	7-102570-1	7-87577-1
50	2.780 [70.61]	2.700 [68.58]	2.400 [60.96]	.190 [4.83]	2.390 [60.71]	7-103167-2	7-102570-2	7-87577-2
52	2.880 [73.15]	2.800 [71.12]	2.500 [63.50]	.190 [4.83]	2.490 [63.25]	7-103167-3	7-102570-3	7-87577-3
54	2.980 [75.69]	2.900 [73.66]	2.600 [66.04]	.190 [4.83]	2.590 [65.79]	7-103167-4	7-102570-4	7-87577-4
56	3.080 [78.23]	3.000 [76.20]	2.700 [68.58]	.190 [4.83]	2.690 [68.33]	7-103167-5	7-102570-5	7-87577-5
58	3.180 [80.77]	3.100 [78.74]	2.800 [71.12]	.190 [4.83]	2.790 [70.87]	7-103167-6	7-102570-6	7-87577-6
60	3.280 [83.31]	3.200 [81.28]	2.900 [73.66]	.190 [4.83]	2.890 [73.41]	7-103167-7	7-102570-7	7-87577-7
62	3.380 [85.85]	3.300 [83.82]	3.000 [76.20]	.190 [4.83]	2.990 [75.95]	7-103167-8	7-102570-8	7-87577-8
64	3.480 [88.39]	3.400 [86.36]	3.100 [78.74]	.190 [4.83]	3.090 [78.49]	7-103167-9	7-102570-9	7-87577-9
66	3.580 [90.93]	3.500 [88.90]	3.200 [81.28]	.190 [4.83]	3.190 [81.03]	8-103167-0	8-102570-0	8-87577-0
68	3.680 [93.47]	3.600 [91.44]	3.300 [83.82]	.190 [4.83]	3.290 [83.57]	8-103167-1	8-102570-1	8-87577-1
70	3.780 [96.01]	3.700 [93.98]	3.400 [86.36]	.190 [4.83]	3.390 [86.11]	8-103167-2	8-102570-2	8-87577-2
72	3.880 [98.55]	3.800 [96.52]	3.500 [88.90]	.190 [4.83]	3.490 [88.65]	8-103167-3	8-102570-3	8-87577-3

Note: All part numbers are RoHS compliant.

Standard Profile Headers—Shrouded, with .066 [1.68] End Dimension, Double-Row, .100 x .100 [2.54 x 2.54] Centerline

.025 [0.64] Square Right-Angle Post (with Pin Protection on 3 Sides)



Material and Finish

Housing — Black thermoplastic, 94V-0 rated

Posts — Phosphor bronze, plated as follows:

Plating A — Duplex plated .000030 [0.00076] gold on contact area, .000100-.000200 [0.00254-0.00508] tin on solder area, with entire post underplated .000050 [0.00127] nickel

Plating B — Duplex plated .000015 [0.00038] gold on contact area, .000100-.000200 [0.00254-0.00508] tin on solder area, with entire post underplated .000050 [0.00127] nickel

Plating C — .000100-.000200 [0.00254-0.00508] tin over .000050 [0.00127] nickel on entire post

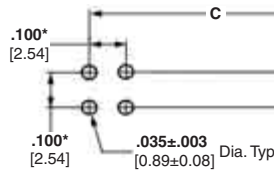
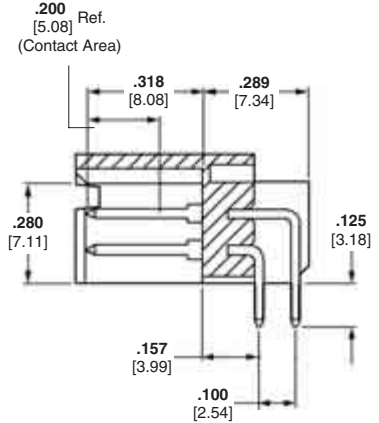
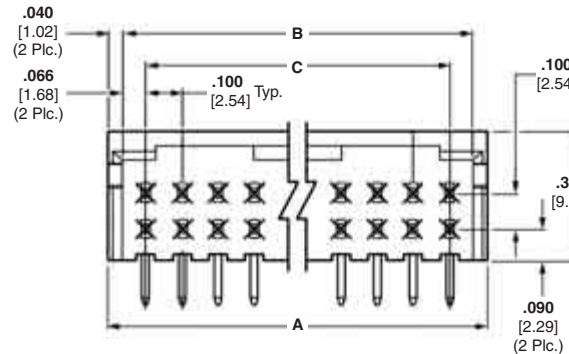

Recommended PC Board Hole Layout (for .055 [1.40] min. thick PC board)

*±.003 [±0.08] tolerances not to accumulate within one connector pattern.

Related Product Data

Mateable Connectors

AMPMODU Board Mount

Receptacles — pages 176, 179, 180

AMPMODU Wire-Applied Receptacles — pages 216, 217

AMPMODU MTE Receptacles — pages 228, 229, 234

AMPMODU MT Receptacles — pages 256, 257

Technical Documents — page 276

See mating connector for applicable product and application specifications.

No. of Pos.	Dimensions			Post Plating/Part Nos.		
	A	B	C	Plating A	Plating B	Plating C
6	.412 [10.46]	.332 [8.43]	.200 [5.08]	5-103164-1	5-102055-2	8-87572-5
8	.512 [13.00]	.432 [10.97]	.300 [7.62]	5-103164-2	5-102055-3	5-87572-1
10	.612 [15.54]	.532 [13.51]	.400 [10.16]	5-103164-3	5-102055-4	5-87572-2
12	.712 [18.08]	.632 [16.05]	.500 [12.70]	5-103164-4	5-102055-5	5-87572-3
14	.812 [20.62]	.732 [18.59]	.600 [15.24]	5-103164-5	5-102055-6	5-87572-4
16	.912 [23.16]	.832 [21.13]	.700 [17.78]	5-103164-6	5-102055-7	5-87572-5
18	1.012 [25.70]	.932 [23.67]	.800 [20.32]	5-103164-7	5-102055-8	5-87572-6
20	1.112 [28.24]	1.032 [26.21]	.900 [22.86]	5-103164-8	5-102055-1	5-87572-7
24	1.312 [33.32]	1.232 [31.29]	1.100 [27.94]	6-103164-0	6-102055-0	—
26	1.412 [35.86]	1.332 [33.83]	1.200 [30.48]	6-103164-1	—	6-87572-0
30	1.612 [40.94]	1.532 [38.91]	1.400 [35.56]	6-103164-3	6-102055-3	—
34	1.812 [46.02]	1.732 [43.99]	1.600 [40.64]	6-103164-5	6-102055-5	6-87572-4
40	2.112 [53.64]	2.032 [51.61]	1.900 [48.26]	6-103164-8	6-102055-8	6-87572-7
50	2.612 [66.34]	2.532 [64.31]	2.400 [60.96]	7-103164-3	7-102055-3	7-87572-2
52	2.712 [68.88]	2.632 [66.85]	2.500 [63.50]	7-103164-4	—	—
54	2.812 [71.42]	2.732 [69.36]	2.600 [66.04]	—	7-102055-5	—
60	3.112 [79.04]	3.032 [77.01]	2.900 [73.66]	7-103164-8	7-102055-8	7-87572-7

Note: All part numbers are RoHS compliant.

Standard Profile Headers, Shrouded

5

Standard Profile Headers—Shrouded, with .150 [3.81] End Dimension, Double-Row, .100 x .100 [2.54 x 2.54] Centerline

.025 [0.64] Square Right-Angle Post (with Pin Protection on 3 Sides)

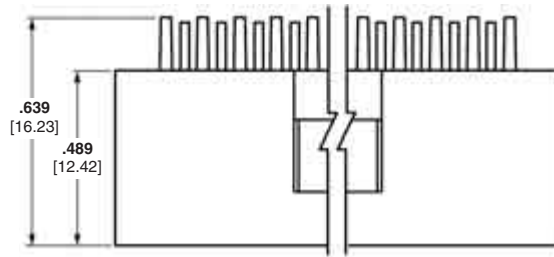
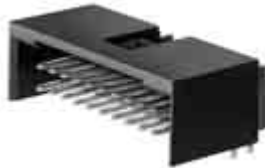

Material and Finish

Housing — Black thermoplastic, 94V-0 rated

Posts — Phosphor bronze, plated as follows:

Plating A — Duplex plated .000030 [0.00076] gold on contact area, .000100-.000200 [0.00254-0.00508] tin on solder area, with entire post underplated .000050 [0.00127] nickel

Plating B — Duplex plated .000015 [0.00038] gold on contact area, .000100-.000200 [0.00254-0.00508] tin on solder area, with entire post underplated .000050 [0.00127] nickel

Plating C — .000100-.000200 [0.00254-0.00508] tin over .000050 [0.00127] nickel on entire post

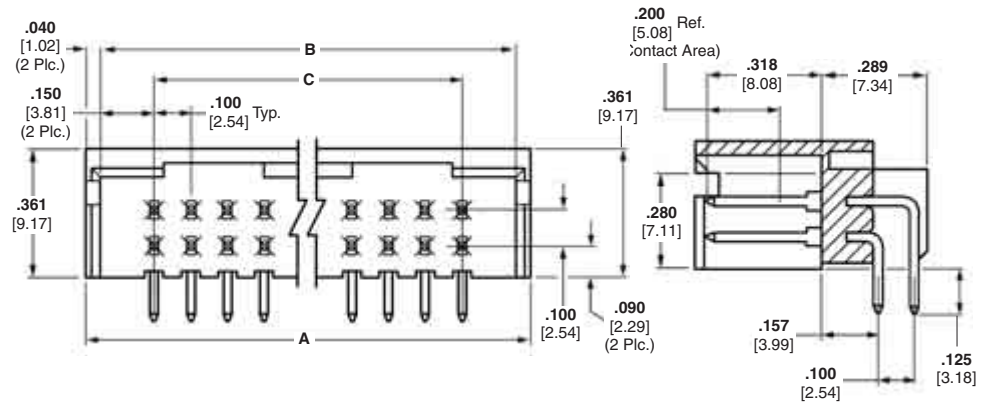

Related Product Data

Mateable Connectors

AMPMODU Wire-Applied

Receptacles — pages 216, 217

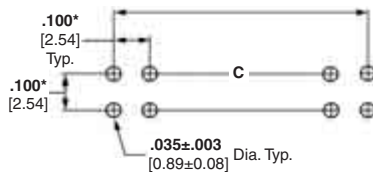

Recommended PC Board Hole Layout (for .055 [1.40] min. thick PC board)

*±.003 [±0.08] tolerances not to accumulate within one connector pattern.

Technical Documents — page 276

See mating connector for applicable product and application specifications.

No. of Pos.	Dimensions			Post Plating/Part Nos.		
	A	B	C	Plating A	Plating B	Plating C
10	.780 [19.81]	.700 [17.78]	.400 [10.16]	5-103165-1	5-102620-1	5-87568-1
12	.880 [22.35]	.800 [20.32]	.500 [12.70]	5-103165-2	5-102620-2	5-87568-2
14	.980 [24.89]	.900 [22.86]	.600 [15.24]	5-103165-3	5-102620-3	5-87568-3
16	1.080 [27.43]	1.000 [25.40]	.700 [17.78]	5-103165-4	5-102620-4	5-87568-4
18	1.180 [29.97]	1.100 [27.94]	.800 [20.32]	5-103165-5	5-102620-5	5-87568-5
20	1.280 [32.51]	1.200 [30.48]	.900 [22.86]	5-103165-6	5-102620-6	5-87568-6
24	1.480 [37.59]	1.400 [35.56]	1.100 [27.94]	5-103165-8	5-102620-8	—
26	1.580 [40.13]	1.500 [38.10]	1.200 [30.48]	5-103165-9	5-102620-9	5-87568-9
30	1.780 [45.21]	1.700 [43.18]	1.400 [35.56]	6-103165-1	6-102620-1	—
34	1.980 [50.29]	1.900 [48.26]	1.600 [40.64]	6-103165-3	6-102620-3	6-87568-3
40	2.280 [57.91]	2.200 [55.88]	1.900 [48.26]	6-103165-6	6-102620-6	6-87568-6
50	2.780 [70.61]	2.700 [68.58]	2.400 [60.96]	7-103165-1	7-102620-1	7-87568-1
60	3.280 [83.31]	3.200 [81.28]	2.900 [73.66]	7-103165-6	7-102620-6	7-87568-6

Note: All part numbers are RoHS compliant.

Standard Profile Headers—Shrouded, with .150 [3.81] End Dimension, Double-Row, .100 x .100 [2.54 x 2.54] Centerline

.025 [0.64] Square Right-Angle Post (with Plastic Holddowns)



Material and Finish

Housing — Black thermoplastic, 94V-0 rated

Posts — Phosphor bronze, duplex plated .000015 [0.00038] gold on contact area, .000100-.000200 [0.00254-0.00508] tin on solder area, with entire post underplated .000050 [0.00127] nickel

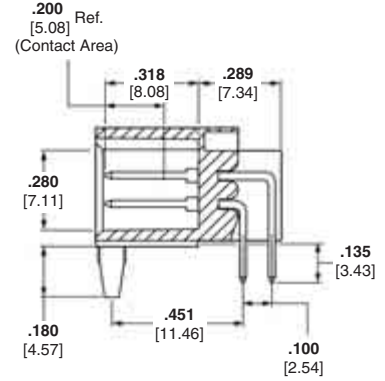
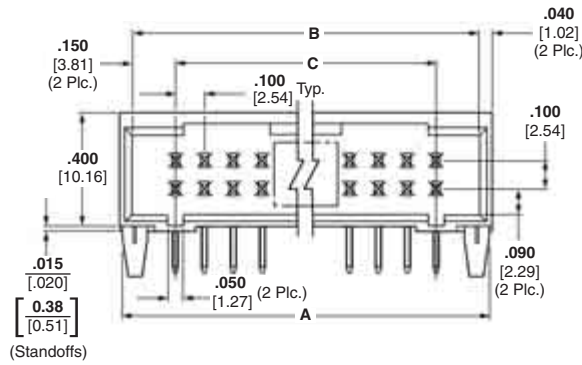
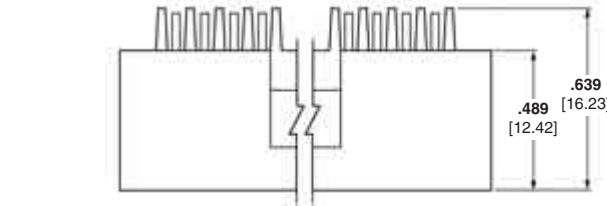

Related Product Data

Mateable Connectors

AMPMODU MTE Receptacles — pages 232, 233, 235 (used with coupling shroud on page 241)

AMPMODU Wire-Applied Receptacles — pages 216-219

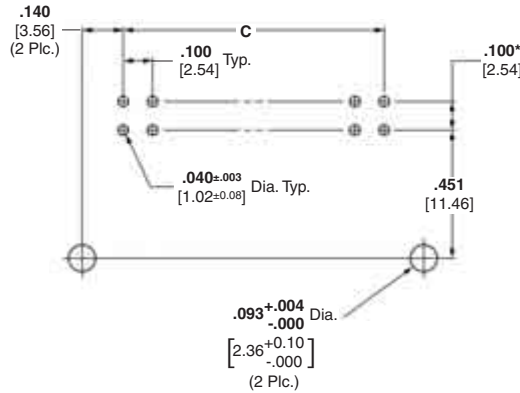

Recommended PC Board Hole Layout (for .055 [1.40] min. thick PC board)

*±.003 [±0.08] tolerances not to accumulate within one connector pattern.

Technical Documents — page 276

See mating connector for applicable product and application specifications.

No. of Pos.	Dimensions			Part Nos.
	A	B	C	
10	.780 [19.81]	.700 [17.78]	.400 [10.16]	5-104319-7
12	.880 [22.35]	.800 [20.32]	.500 [12.70]	5-104319-8
14	.980 [24.89]	.900 [22.86]	.600 [15.24]	5-104319-5
16	1.080 [27.43]	1.000 [25.40]	.700 [17.78]	5-104319-1
20	1.280 [32.51]	1.200 [30.48]	.900 [20.86]	5-104319-2
30	1.780 [45.21]	1.700 [43.18]	1.400 [35.56]	5-104319-3
34	1.980 [50.29]	1.900 [48.26]	1.600 [40.64]	5-104319-6
40	2.280 [57.91]	2.200 [55.88]	1.900 [48.26]	5-104319-4
48	2.680 [68.07]	2.600 [66.04]	2.300 [58.42]	5-104319-9

Note: All part numbers are RoHS compliant.

Standard Profile Headers—Shrouded, with .150 [3.81] End Dimension, Double-Row, .100 x .100 [2.54 x 2.54] Centerline (Continued)

.025 [0.64] Square Straight Post (with Detent Windows and Mounting Ears)



Material and Finish

Housing — Black thermoplastic, 94V-0 rated

Posts — Copper alloy, plated .000030 [0.00076] gold over .000050 [0.00127] nickel on entire post

Related Product Data

Mateable Connectors

AMPMODU Wire-Applied Receptacles — pages 216-219

AMPMODU MTE Receptacles — pages 232, 233, 235 (used with coupling shroud on page 241)

Accessories

Barrier Insert — page 204

Technical Documents — page 276

See mating connector for applicable product and application specifications.

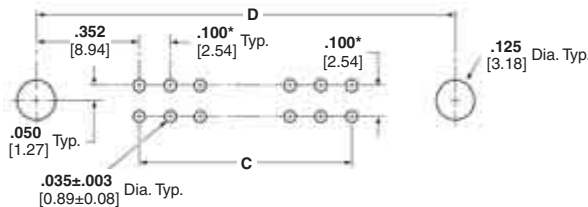
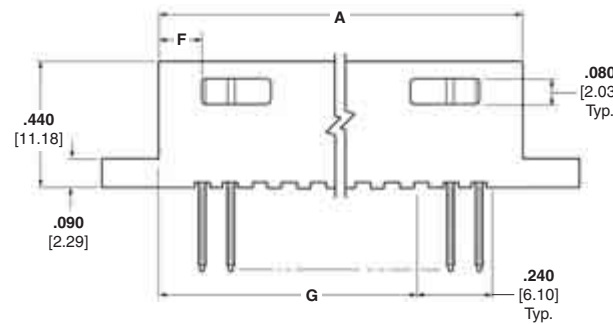
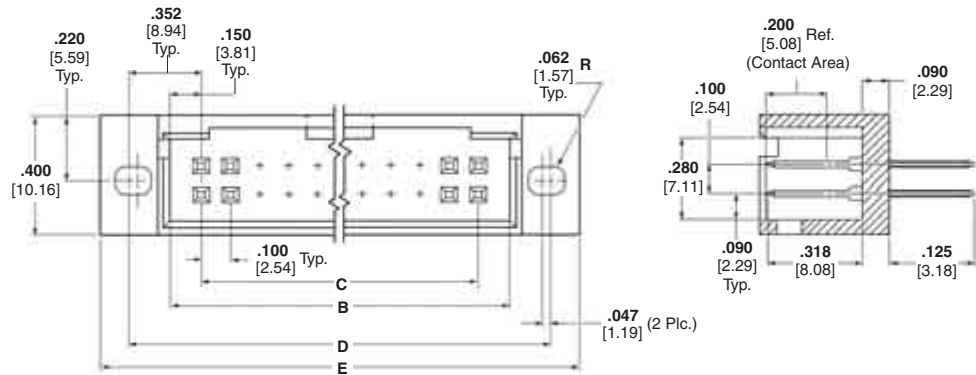

Recommended PC Board Hole Layout
(for .055 [1.40] min. thick PC board)

*±.003 [±0.08] tolerances not to accumulate within one connector pattern.

No. of Pos.	Dimensions							Part Nos.
	A	B	C	D	E	F	G	
10	.780 [19.81]	.700 [17.78]	.400 [10.16]	1.104 [28.04]	1.304 [33.12]	.290 [7.37]	—	87474-1
14	.980 [24.89]	.900 [22.86]	.600 [15.24]	1.304 [33.12]	1.504 [38.20]	.190 [4.83]	—	87474-9
20	1.280 [32.51]	1.200 [30.48]	.900 [22.86]	1.604 [40.74]	1.804 [45.82]	.190 [4.83]	.890 [22.61]	87474-2
24	1.480 [37.59]	1.400 [35.56]	1.100 [27.94]	1.804 [45.82]	2.004 [50.90]	.190 [4.83]	1.090 [27.69]	1-87474-3
26	1.580 [40.13]	1.500 [38.10]	1.200 [30.48]	1.904 [48.36]	2.104 [53.44]	.190 [4.83]	1.190 [30.23]	87474-3
34	1.980 [50.29]	1.900 [48.26]	1.600 [40.64]	2.304 [58.52]	2.504 [63.60]	.190 [4.83]	1.590 [40.39]	87474-4
40	2.280 [57.91]	2.200 [55.88]	1.900 [48.26]	2.604 [66.14]	2.804 [71.22]	.190 [4.83]	1.890 [48.01]	87474-6
50	2.780 [70.61]	2.700 [68.58]	2.400 [60.96]	3.104 [78.84]	3.304 [83.92]	.190 [4.83]	2.390 [60.71]	87474-7
60	3.280 [83.31]	3.200 [81.28]	2.900 [73.66]	3.604 [91.54]	3.804 [96.62]	.190 [4.83]	2.890 [73.41]	2-87474-6

Note: All part numbers are RoHS compliant.

Standard Profile Headers—Shrouded Bulkhead Type; with .066 [1.68] End Dimension, Double-Row, .100 x .100 [2.54 x 2.45] Centerline

.025 [0.64] Square Straight Post (with Detent Windows and Mounting Ears)

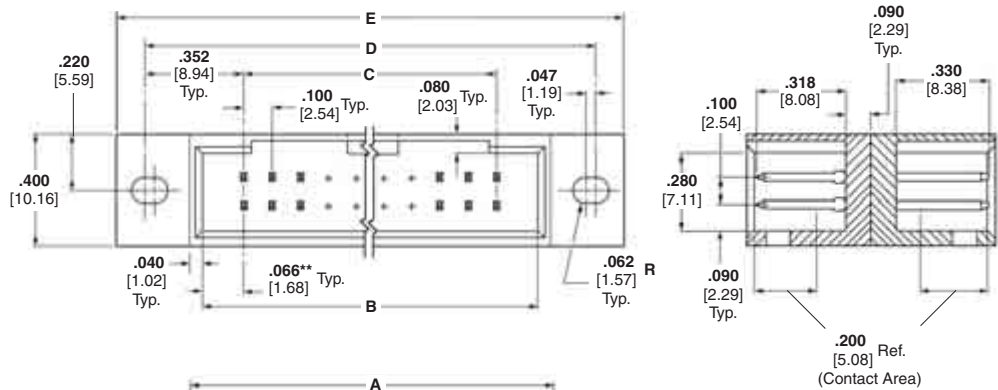

Material and Finish

Housing — Black thermoplastic, 94V-0 rated

Posts — Copper alloy, plated .000030 [0.00076] gold over .000050 [0.00127] nickel on entire post

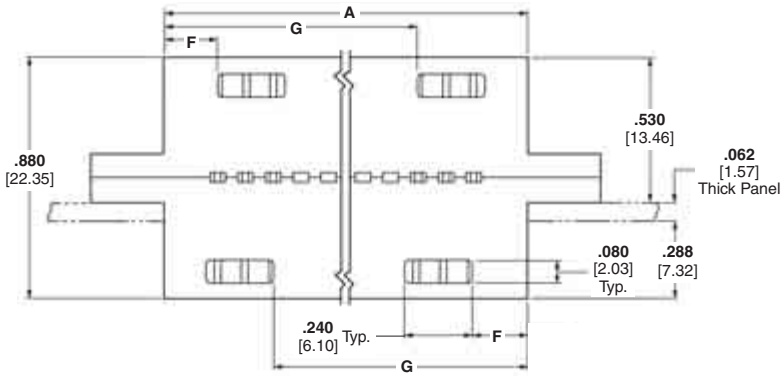

Related Product Data

Mateable Connectors

AMPMODU Board Mount Receptacles — pages 176, 179, 180

AMPMODU Wire-Applied Receptacles — pages 216-219

AMPMODU MTE Receptacles — pages 228, 229, 234

AMPMODU MT Receptacles — pages 256, 257

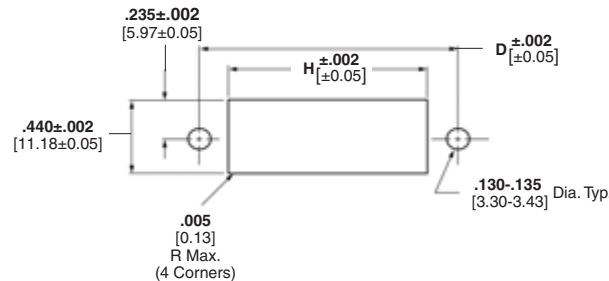

Recommended Panel Cutout

**Both mating faces have same end dimension.

Accessories

Barrier Insert — page 204

Technical Documents — page 276

See mating connector for applicable product and application specifications.

No. of Pos.	Dimensions								Part Nos.
	A	B	C	D	E	F	G	H	
10	.612 [15.54]	.532 [13.51]	.400 [10.16]	1.104 [28.04]	1.304 [33.12]	.206 [5.23]	—	.632 [16.05]	87608-1
12	.712 [18.08]	.632 [16.05]	.500 [12.70]	1.204 [30.58]	1.404 [35.66]	.206 [5.23]	—	.732 [18.59]	87608-2
20	1.112 [28.24]	1.032 [26.21]	.900 [22.86]	1.604 [40.74]	1.804 [45.82]	.106 [2.69]	.806 [20.47]	1.132 [28.75]	87608-6
24	1.312 [33.32]	1.232 [31.29]	1.100 [27.94]	1.804 [45.82]	2.004 [50.90]	.106 [2.69]	1.006 [25.55]	1.332 [33.83]	87608-8
26	1.412 [35.86]	1.332 [33.83]	1.200 [30.48]	1.904 [48.36]	2.104 [53.44]	.106 [2.69]	1.106 [28.09]	1.432 [36.37]	87608-9
34	1.812 [46.02]	1.732 [43.99]	1.600 [40.64]	2.304 [58.52]	2.504 [63.60]	.106 [2.69]	1.506 [38.25]	1.832 [46.53]	1-87608-3
40	2.112 [53.64]	2.032 [51.61]	1.900 [48.26]	2.604 [66.14]	2.804 [71.22]	.106 [2.69]	1.806 [45.87]	2.132 [54.15]	1-87608-6
50	2.612 [66.34]	2.532 [64.31]	2.400 [60.96]	3.104 [78.84]	3.304 [83.92]	.106 [2.69]	2.306 [58.57]	2.632 [66.85]	2-87608-1
60	3.112 [79.04]	3.032 [77.01]	2.900 [73.66]	3.604 [91.54]	3.804 [96.62]	.106 [2.69]	2.806 [71.27]	3.132 [79.55]	2-87608-6

Note: All part numbers are RoHS compliant.

Standard Profile Headers, Shrouded

5

Standard Profile Headers—Shrouded Bulkhead Type; with .150 [3.81] End Dimension, Double-Row, .100 x .100 [2.54 x 2.45] Centerline

.025 [0.64] Square Straight Post (with Detent Windows and Mounting Ears)

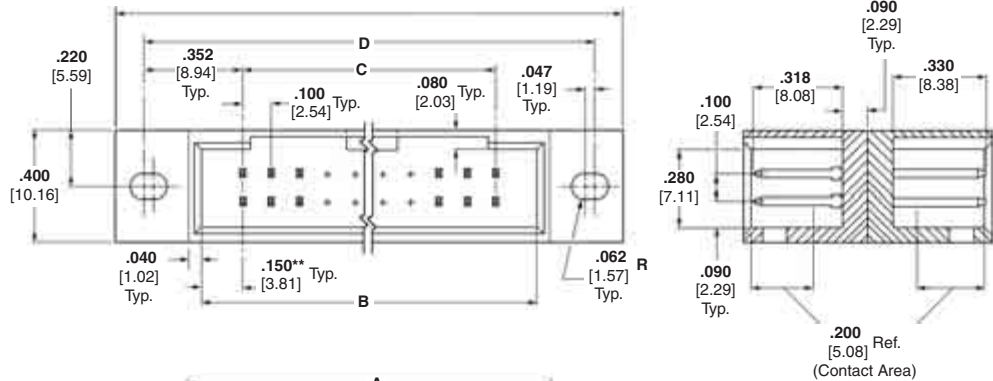

Material and Finish

Housing — Black thermoplastic, 94V-0 rated

Posts — Copper alloy, plated .000030 [0.00076] gold over .000050 [0.00127] nickel on entire post

Related Product Data

Mateable Connectors

AMPMODU MTE Receptacles — pages 232, 233, 235 (used with coupling shroud on page 241)

AMPMODU Wire-Applied Receptacles — pages 216-219

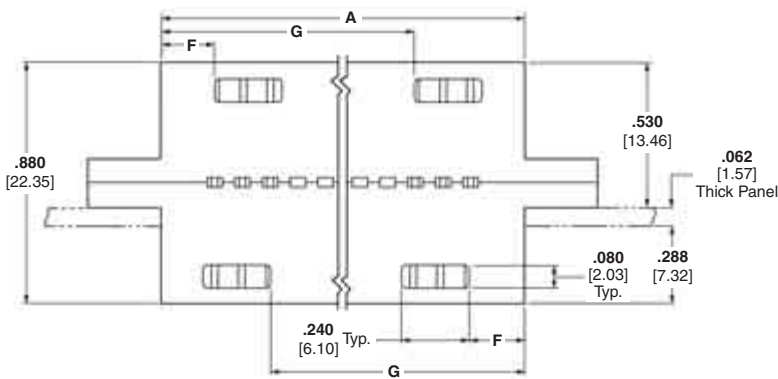

Accessories

Barrier Insert — page 204

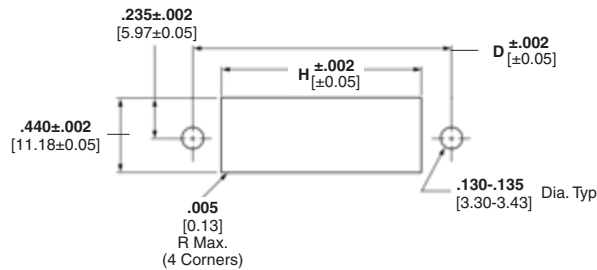

Technical Documents — page 276

See mating connector for applicable product and application specifications.

Recommended Panel Cutout

**Both mating faces have same end dimension.

No. of Pos.	Dimensions								Part Nos.
	A	B	C	D	E	F	G	H	
10	.780 [19.81]	.700 [17.78]	.400 [10.16]	1.104 [28.04]	1.304 [33.12]	.290 [7.37]	—	.800 [20.32]	87605-1
20	1.280 [32.51]	1.200 [30.48]	.900 [22.86]	1.604 [40.74]	1.804 [45.82]	.190 [4.83]	.890 [22.61]	1.300 [33.02]	87605-6
24	1.480 [37.59]	1.400 [35.56]	1.100 [27.94]	1.804 [45.82]	2.004 [50.90]	.190 [4.83]	1.090 [27.69]	1.500 [38.10]	87605-8
26	1.580 [40.13]	1.500 [38.10]	1.200 [30.48]	1.904 [48.36]	2.104 [53.44]	.190 [4.83]	1.190 [30.23]	1.600 [40.64]	87605-9
30	1.780 [45.21]	1.700 [43.18]	1.400 [35.56]	2.104 [53.44]	2.304 [58.52]	.190 [4.83]	1.390 [35.31]	1.800 [45.72]	1-87605-1
32	1.880 [47.75]	1.800 [45.72]	1.500 [38.10]	2.204 [55.98]	2.404 [61.06]	.190 [4.83]	1.490 [37.85]	1.900 [48.26]	1-87605-2
34	1.980 [50.29]	1.900 [48.26]	1.600 [40.64]	2.304 [58.52]	2.504 [63.60]	.190 [4.83]	1.590 [40.39]	2.000 [50.80]	1-87605-3
40	2.280 [57.91]	2.200 [55.88]	1.900 [48.26]	2.604 [66.14]	2.804 [71.22]	.190 [4.83]	1.890 [48.01]	2.300 [58.42]	1-87605-6
50	2.780 [70.61]	2.700 [68.58]	2.400 [60.96]	3.104 [78.84]	3.304 [83.92]	.190 [4.83]	2.390 [60.71]	2.800 [71.12]	2-87605-1
60	3.280 [83.31]	3.200 [81.28]	2.900 [73.66]	3.604 [91.54]	3.804 [96.62]	.190 [4.83]	2.890 [73.41]	3.300 [83.82]	2-87605-6

Note: All part numbers are RoHS compliant.

Standard Profile Headers—Shrouded Bulkhead Type; with .066/.150 [1.68/3.81] End Dimension, Double-Row, .100 x .100 [2.54 x 2.45] Centerline

.025 [0.64] Square Straight Post (with Detent Windows and Mounting Ears)

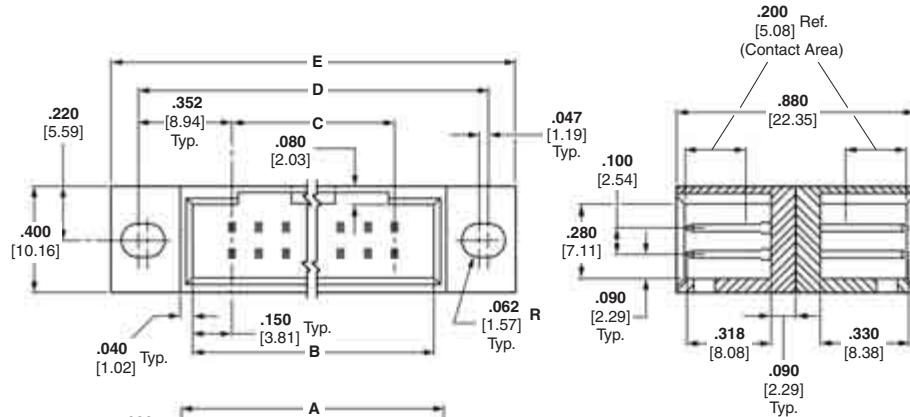

Material and Finish

Housing — Black thermoplastic, 94V-0 rated

Posts — Copper alloy, plated .000030 [0.00076] gold over .000050 [0.00127] nickel on entire post

Related Product Data

Mateable Connectors with .066 [1.68] End Dimension — AMPMODU Board Mount Receptacles — pages 176, 179, 180

AMPMODU Wire-Applied Receptacles — pages 216-219
AMPMODU MTE Receptacles — pages 228, 229, 234

AMPMODU MT Receptacles — pages 256, 257

Mateable Connectors with .150 [3.81] End Dimension — AMPMODU MTE Receptacles — pages 232, 233, 235 (used with coupling shroud on page 241)

Accessories

Barrier Insert — page 204

Technical Documents — page 276

See mating connector for applicable product and application specifications.

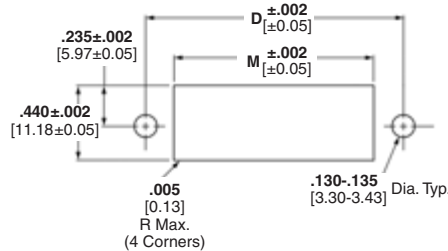
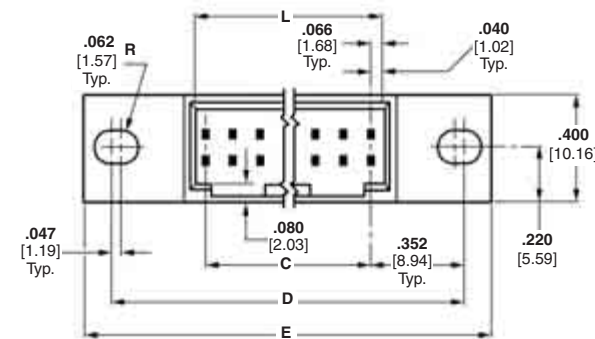
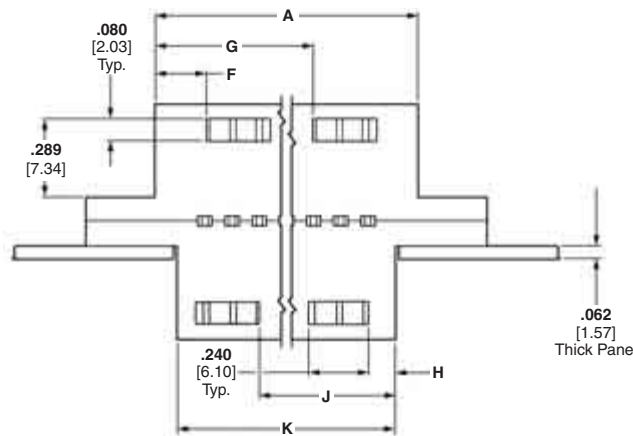

Recommended Panel Cutout

Standard Profile Headers,
Shrouded

5

Standard Profile Headers—Shrouded Bulkhead Type; with .066/.150 [1.68/3.81] End Dimension, Double-Row, .100 x .100 [2.54 x 2.45] Centerline (Continued)



No. of Pos.	Dimensions						Part Nos.
	A	B	C	D	E	F	
10	.780 [19.81]	.700 [17.78]	.400 [10.16]	1.104 [28.04]	1.304 [33.12]	.290 [7.37]	87496-2
20	1.280 [32.51]	1.200 [30.48]	.900 [22.86]	1.604 [40.74]	1.804 [45.82]	.190 [4.83]	87496-7
24	1.480 [37.59]	1.400 [35.56]	1.100 [27.94]	1.804 [45.82]	2.004 [50.90]	.190 [4.83]	87496-9
26	1.580 [40.13]	1.500 [38.10]	1.200 [30.48]	1.904 [48.36]	2.104 [53.44]	.190 [4.83]	1-87496-0
30	1.780 [45.21]	1.700 [43.18]	1.400 [35.56]	2.104 [53.44]	2.304 [58.52]	.190 [4.83]	1-87496-2
34	1.980 [50.29]	1.900 [48.26]	1.600 [40.64]	2.304 [58.52]	2.504 [63.60]	.190 [4.83]	1-87496-4
40	2.280 [57.91]	2.200 [55.88]	1.900 [48.26]	2.604 [66.14]	2.804 [71.22]	.190 [4.83]	1-87496-7
50	2.780 [70.61]	2.700 [68.58]	2.400 [60.96]	3.304 [83.92]	3.304 [83.92]	.190 [4.83]	87496-1
60	3.280 [83.31]	3.200 [81.38]	2.900 [73.66]	3.604 [91.54]	3.804 [96.62]	.190 [4.83]	2-87496-6

No. of Pos.	Dimensions						Part Nos.
	G	H	J	K	L	M	
10	—	.206 [5.23]	—	.612 [15.54]	.532 [13.51]	.632 [16.05]	87496-2
20	.890 [22.61]	.106 [2.69]	.806 [20.47]	1.112 [28.24]	1.032 [26.21]	1.132 [28.75]	87496-7
24	1.090 [27.69]	.106 [2.69]	1.006 [25.55]	1.312 [33.32]	1.232 [31.29]	1.332 [33.83]	87496-9
26	1.190 [30.23]	.106 [2.69]	1.106 [28.09]	1.412 [35.86]	1.332 [33.83]	1.432 [36.37]	1-87496-0
30	1.390 [35.31]	.106 [2.69]	1.306 [33.17]	1.612 [40.94]	1.532 [38.91]	1.632 [41.45]	1-87496-2
34	1.590 [40.39]	.106 [2.69]	1.506 [38.25]	1.812 [46.02]	1.732 [43.99]	1.832 [46.53]	1-87496-4
40	1.890 [48.01]	.106 [2.69]	1.806 [45.87]	2.112 [53.64]	2.032 [51.61]	2.132 [54.15]	1-87496-7
50	2.390 [60.71]	.106 [2.69]	2.306 [58.57]	2.612 [66.34]	2.532 [64.31]	2.632 [66.85]	87496-1
60	2.890 [73.41]	.106 [2.69]	2.806 [71.27]	3.112 [79.04]	3.032 [77.01]	3.132 [79.55]	2-87496-6

Note: All part numbers are RoHS compliant.

AMP-LATCH Low Profile Headers—Shrouded

Product Facts

- Available in selected positions 10 thru 60
- Flame retardant, thermoplastic housings, 94V-0 rated
- Vertical and right-angle versions available in double row configurations
- Available in .025 [0.64] square drawn wire posts
- Wash out clearance for flux removal
- Mates with AMP-LATCH Ribbon Cable Connectors
- Available with and without eject latches
- Available with and without kinked soldertails for PCB retention
- Recognized under the Component Program of Underwriters Laboratories Inc.  File No. E28476
- Certified by Canadian Standards Association,  File No. LR 7189

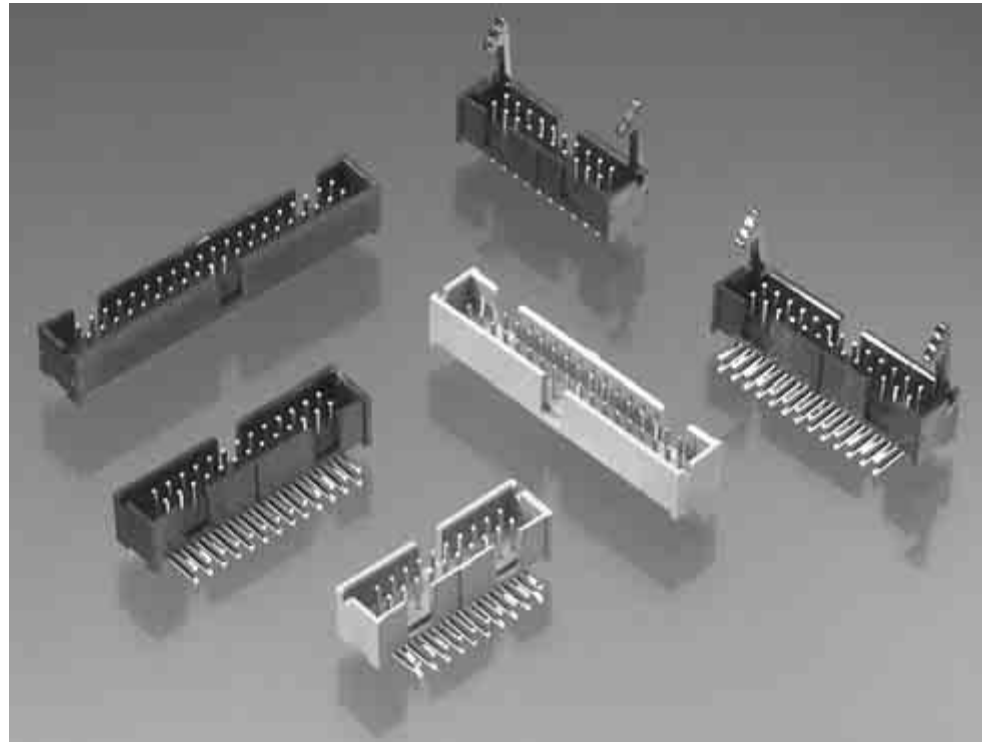

Performance Characteristics

Electrical

Insulation Resistance — 5,000 megohms minimum initial

Dielectric Withstanding Voltage — 1,000 V rms at sea level

Environmental

Operating Temperature — -65°C to +105°C

Current — 1 ampere maximum per contact

AMP-LATCH Low Profile Headers—Shrouded, with .150 [3.81] End Dimension, Double-Row, .100 x .100 [2.54 x 2.54] Centerline

.025 [0.64] Square Straight Post

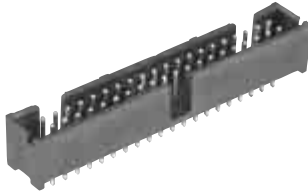

Material and Finish

Housing — Glass-filled nylon, black, 94V-0 rated

Posts — Copper alloy, plated as follows:

Plating A — Gold flash over .000030 [0.00076] min. palladium-nickel plate on the mating surfaces, .000100 [0.00254] min. tin plate on soldertails, with entire post underplated .000050 [0.00127] min. nickel

Plating B — Gold flash over .000015 [0.00038] min. palladium-nickel plate on the mating surfaces, .000100 [0.00254] min. tin plate on soldertails, with entire post underplated .000050 [0.00127] min. nickel

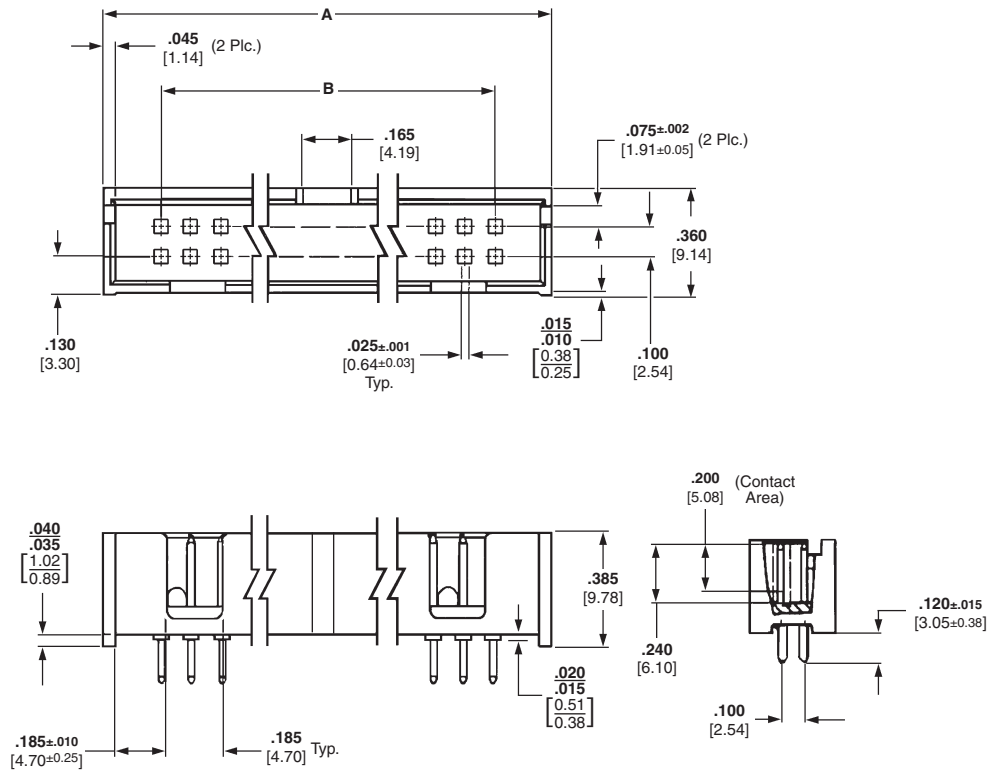

Related Product Data

Electrical Characteristics — page 134

Mateable Connectors —

AMPMODU Wire-Applied Receptacles — page 220

AMPMODU Board Mount Receptacles — pages 179, 180

Short Point Wire-Applied Connectors — page 224

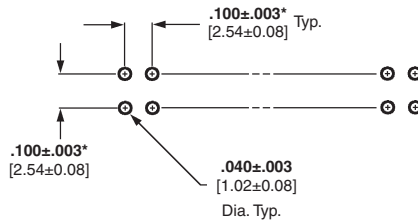

Recommended PC Board Hole Layout For Manual Insertion

*±.003 [±0.08] tolerances not to accumulate within one connector pattern.

No. of Pos.	Dimensions		Post Plating/Part Nos.	
	A	B	Plating A	Plating B
10	.800 [20.32]	.400 [10.16]	5103309-1	5103308-1
14	1.000 [25.40]	.600 [15.24]	5103309-2	5103308-2
16	1.100 [27.94]	.700 [17.78]	5103309-3	5103308-3
20	1.300 [33.02]	.900 [22.86]	5103309-5	5103308-5
24	1.400 [35.56]	1.100 [27.94]	—	1-5103308-3
26	1.600 [40.64]	1.200 [30.48]	5103309-6	5103308-6
34	2.000 [50.80]	1.600 [40.64]	5103309-7	5103308-7
40	2.300 [58.42]	1.900 [48.26]	5103309-8	5103308-8
50	2.800 [71.12]	2.400 [60.96]	1-5103309-0	1-5103308-0
60	3.300 [83.82]	2.900 [73.66]	—	1-5103308-2

Note: All part numbers are RoHS compliant.

AMP-LATCH Low Profile Headers—Shrouded, with .150 [3.81] End Dimension, Double-Row, .100 x .100 [2.54 x 2.54] Centerline (Continued)

.025 [0.64] Square Right-Angle Post

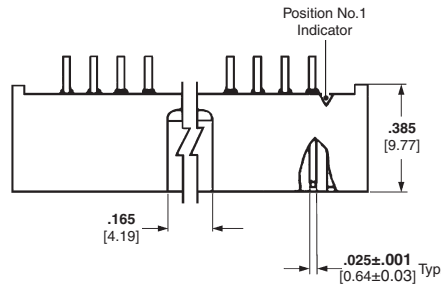
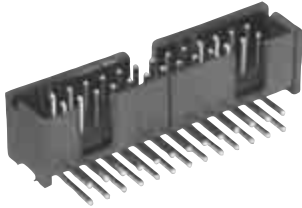

Material and Finish

Housing — Glass-filled nylon, black, 94V-0 rated

Posts — Copper alloy, plated as follows:

Plating A — Gold flash over .000030 [0.00076] min. palladium-nickel plate on the mating surfaces, .000100 [0.00254] min. tin plate on soldertails, with entire post underplated .000050 [0.00127] min. nickel

Plating B — Gold flash over .000015 [0.00038] min. palladium-nickel plate on the mating surfaces, .000100 [0.00254] min. tin plate on soldertails, with entire post underplated .000050 [0.00127] min. nickel

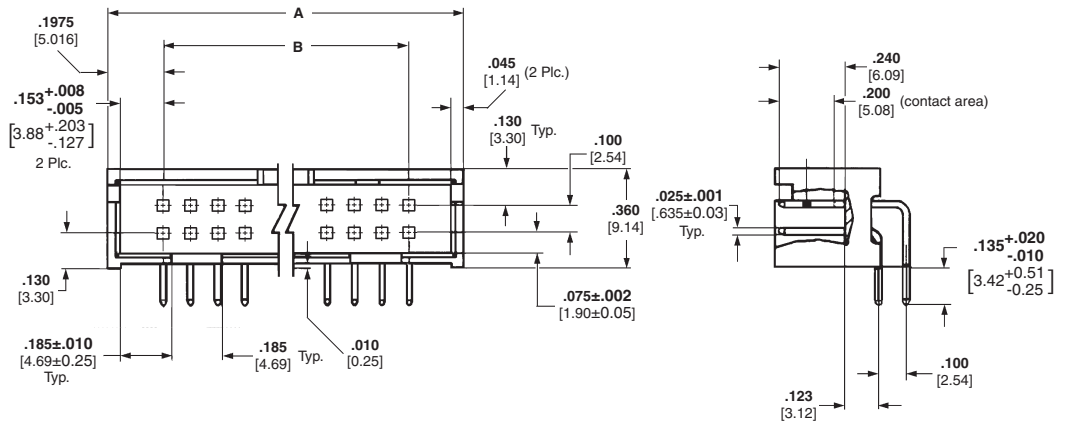

Related Product Data

Electrical Characteristics — page 134

Mateable Connectors — AMPMODU Wire-Applied Receptacles — page 220

Short Point Wire-Applied Connectors — page 224

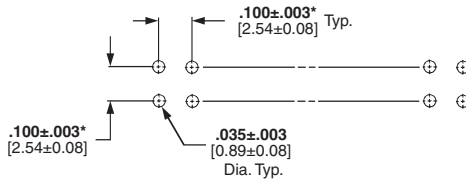

Recommended PC Board Hole Layout For Manual Insertion

*±.003 [±0.08] tolerances not to accumulate within one connector pattern.

No. of Pos.	Dimensions		Post Plating/Part Nos.	
	A	B	Plating A	Plating B
10	.800 [20.32]	.400 [10.16]	5103311-1	5103310-1
14	1.000 [25.40]	.600 [15.24]	5103311-2	5103310-2
16	1.100 [27.94]	.700 [17.78]	5103311-3	5103310-3
20	1.300 [33.02]	.900 [22.86]	5103311-5	5103310-5
26	1.600 [40.64]	1.200 [30.48]	5103311-6	5103310-6
34	2.000 [50.80]	1.600 [40.64]	5103311-7	5103310-7
40	2.300 [58.42]	1.900 [48.26]	5103311-8	5103310-8
50	2.800 [71.12]	2.400 [60.96]	1-5103311-0	1-5103310-0
60	3.300 [83.82]	2.900 [73.66]	1-5103311-2	—

Note: All part numbers are RoHS compliant.

AMP-LATCH Low Profile Headers—Shrouded, with .150 [3.81] End Dimension, Double-Row, .100 x .100 [2.54 x 2.54] Centerline & “Kinked” Solderetails for PCB Retention

.025 [0.64] Square Straight Post (with Board Retention Feature)

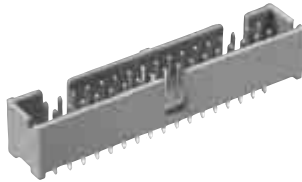

Material and Finish

Housing — Glass-filled PPA, black, 94V-0 rated

Posts — Copper alloy, plated with gold flash over .000015 [0.00038] min. palladium-nickel plate on the mating surfaces, .000100 [0.00254] min. tin plate on solderetails, with entire post underplated .000050 [0.00127] min. nickel

Related Product Data

Electrical Characteristics — page 134

Mateable Connectors —

AMPMODU Wire-Applied Receptacles — page 220

AMPMODU Board Mount Receptacles — pages 179, 180

Short Point Wire-Applied Connectors — page 224

*Reflow solder process compatible

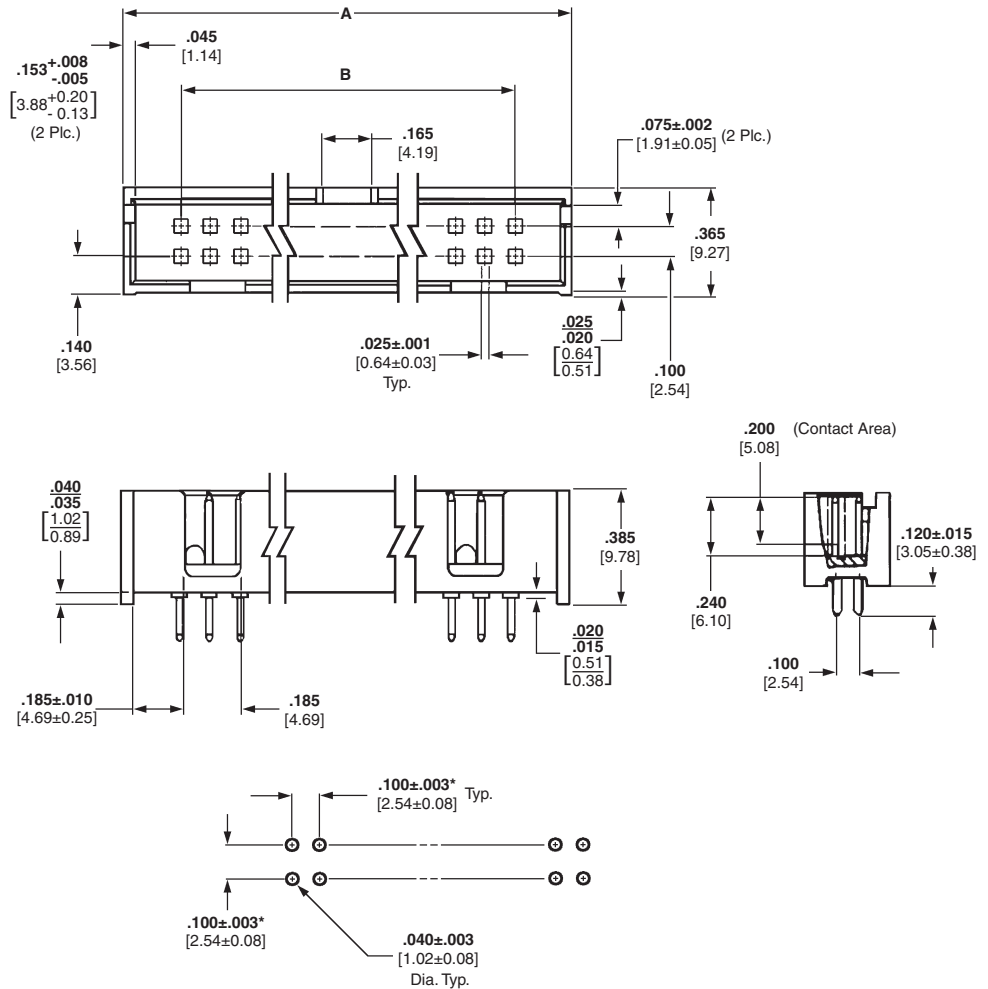

Recommended PC Board Hole Layout For Manual Insertion

*±.003 [±0.08] tolerances not to accumulate within one connector pattern.

No. of Pos.	Dimensions		Post Plating Part Nos.
	A	B	
10	.800 [20.32]	.400 [10.16]	5104338-1
14	1.000 [25.40]	.600 [15.24]	5104338-2
16	1.100 [27.94]	.700 [17.78]	5104338-3
20	1.300 [33.02]	.900 [22.86]	5104338-4
24	1.400 [35.56]	1.100 [27.94]	5104338-5
34	2.000 [50.80]	1.600 [40.64]	5104338-7
40	2.300 [58.42]	1.900 [48.26]	5104338-8
50	2.800 [71.12]	2.400 [60.96]	5104338-9
60	3.300 [83.82]	2.900 [73.66]	1-5104338-0

Note: All part numbers are RoHS compliant.

AMP-LATCH Low Profile Headers—Shrouded, with .150 [3.81] End Dimension, Double-Row, .100 x .100 [2.54 x 2.54] Centerline & “Kinked” Solderetails for PCB Retention (Continued)

.025 [0.64] Square Right-Angle Post (with Board Retention Feature)

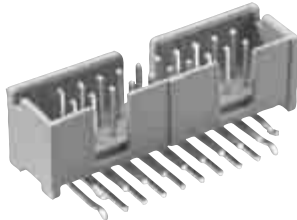

Material and Finish

Housing — Glass-filled PPA, black, 94V-0 rated

Posts — Copper alloy, plated with gold flash over .000015 [0.00038] min. palladium-nickel plate on the mating surfaces, .000100 [0.00254] min. tin plate on solderetails, with entire post underplated .000050 [0.00127] min. nickel

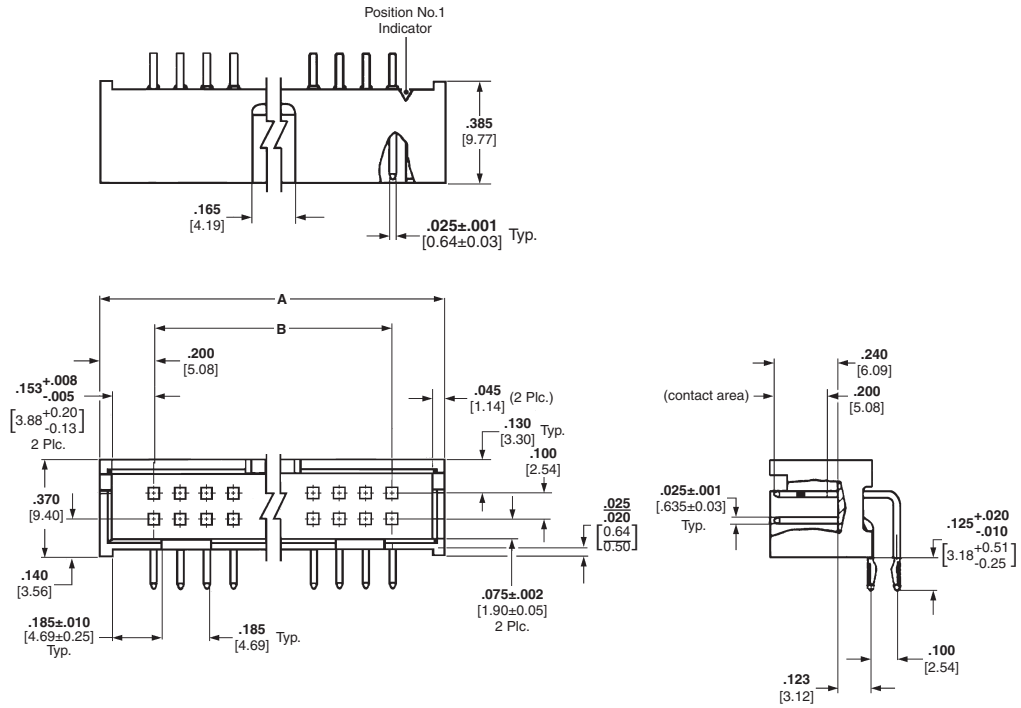

Related Product Data

Electrical Characteristics — page 134

Mateable Connectors —

AMPMODU Wire-Applied Receptacles — page 220

Short Point Wire-Applied Connectors — page 224

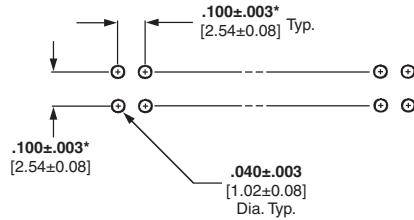

Recommended PC Board Hole Layout For Manual Insertion

*±.003 [±0.08] tolerances not to accumulate within one connector pattern.

No. of Pos.	Dimensions		Post Plating Part Nos.
	A	B	
10	.800 [20.32]	.400 [10.16]	5104340-1
14	1.000 [25.40]	.600 [15.24]	5104340-2
16	1.100 [27.94]	.700 [17.78]	5104340-3
20	1.300 [33.02]	.900 [22.86]	5104340-4
40	2.300 [58.42]	1.900 [48.26]	5104340-8
50	2.800 [71.12]	2.400 [60.96]	5104340-9

Note: All part numbers are RoHS compliant.

Universal Ejection Style Pin Headers, Military, Center and Dual Polarized, .100 x .100 [2.54 x 2.54] Centers

Straight-Thru, 4-Sided .025 [0.64] Sq. Posts



Pin Header with Latches



Pin Header without Latches

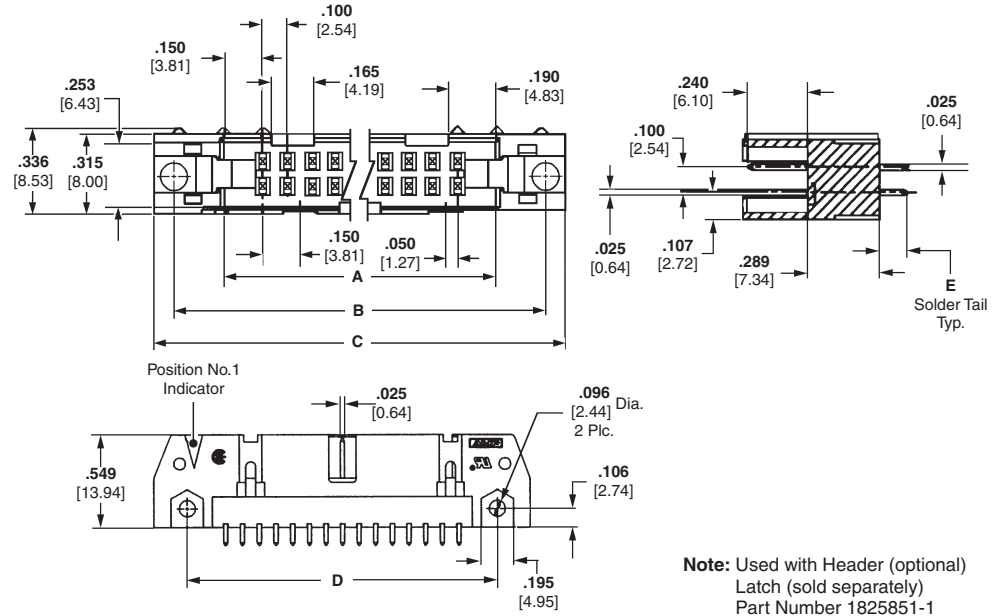

Note: Used with Header (optional) Latch (sold separately) Part Number 1825851-1

Material and Finish

Housing & Latches — Black thermoplastic, 94V-0 rated

Contacts — Brass or phosphor bronze (at Tyco Electronics' option); Duplex .000030 [0.00076] gold on mating end, .000100 [0.00254] min. tin on termination end, with entire contact underplated .000050 [0.00127] nickel

Related Product Data

Electrical Characteristics — page 134

Mateable Connectors —

AMPMODU Wire-Applied Receptacles — page 220

Mounting Information

4-24 self-tapping screws and 2-56 bolts and nuts are available for mounting straight-thru pin headers of pc boards. Typical applications and part nos. for ordering this hardware are presented below.

Note: 2-56 bolts and nuts may be used to mount pin headers with and without latches. If latches are to be used, the bolts must be positioned in the pin header before the latches are installed.

Note: All part numbers are RoHS compliant.

No. of Positions	Dimensions					Part Number (Without Latches)
	A	B	C	D	E	
10	.700	1.100	1.260	.860	.110 [2.79]	5102154-1
	17.78	27.94	32.00	21.84	.155 [3.94]	5102156-1
14	.900	1.300	1.460	1.060	.110 [2.79]	5102154-2
	22.86	33.02	37.08	26.92	.155 [3.94]	5102156-2
16	1.000	1.400	1.560	1.180	.110 [2.79]	5102154-3
	25.40	35.56	39.62	29.46	.155 [3.94]	5102156-3
20	1.200	1.600	1.760	1.360	.110 [2.79]	5102154-4
	30.48	40.64	44.70	34.54	.155 [3.94]	5102156-4
24	1.400	1.800	1.960	1.560	.110 [2.79]	5102154-5
	35.56	45.72	49.78	39.62	.155 [3.94]	5102156-5
26	1.500	1.900	2.060	1.660	.110 [2.79]	5102154-6
	38.10	48.26	52.32	42.16	.155 [3.94]	5102156-6
34	1.900	2.300	2.460	2.060	.110 [2.79]	5102154-8
	48.26	58.42	62.48	52.32	.155 [3.94]	5102156-8
40	2.200	2.600	2.760	2.360	.110 [2.79]	5102154-9
	55.88	66.04	70.10	59.94	.155 [3.94]	5102156-9
50	2.700	3.100	3.260	2.860	.110 [2.79]	1-5102154-0
	68.58	78.74	82.80	72.64	.155 [3.94]	1-5102156-0

- Notes:** 1. Pin headers in 10- and 14-position sizes have only one slot for snap-in polarizer (military polarization), located as shown.
2. Pin headers in 10-position size have only slot for dual polarization, located as shown.

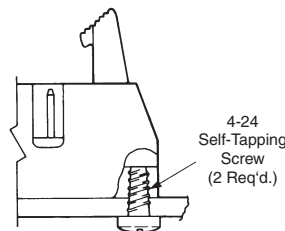

Pin Header Mounting using 4-24 Self-Tapping Screws:
Part No. 19156-1 (for .062 [1.57] Thick PC Board)
19156-2 (for .093 [2.36] Thick PC Board)
19156-3 (for .125 [3.18] Thick PC Board)

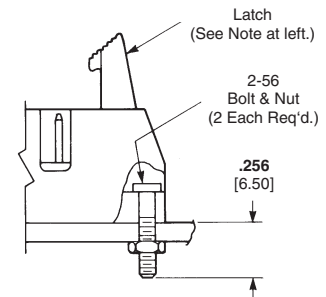

Pin Header Mounting with 2-56 Bolts and Nuts:
Part No. 746383-1 (Bolt Only)
Kit No. 102198-1 (Bolt and Nut, 2 Each per Kit)

Universal Ejection Style Pin Headers, Military, Center and Dual Polarized, .100 x .100 [2.54 x 2.54] Centers (Continued)

**Right-Angle, 4-Sided
.025 [0.64] Sq. Posts**



Pin Header with Latches



Pin Header without Latches

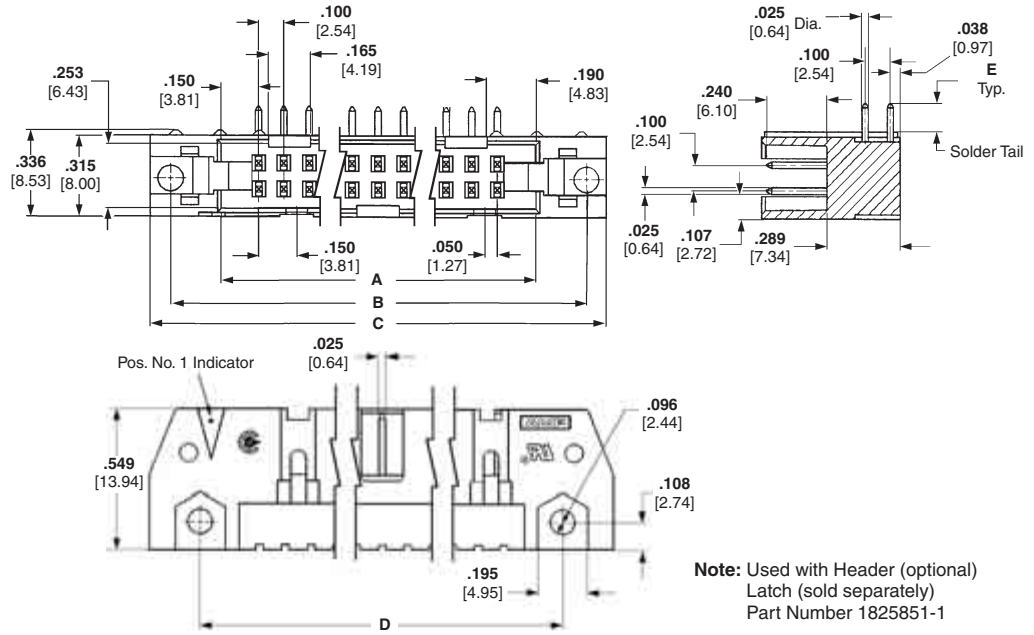

Note: Used with Header (optional) Latch (sold separately) Part Number 1825851-1

Material and Finish

Housing & Latches — Black thermoplastic, 94V-0 rated

Contacts — Brass or phosphor bronze (at Tyco Electronics' option); Duplex .000030 [0.00076] gold on mating end, .000100 [0.00254] min. tin on termination end, with entire contact underplated .000050 [0.00127] nickel

Related Product Data

Electrical Characteristics — page 134

Mateable Connectors — AMPMODU Wire-Applied Receptacles — page 220

Mounting Information

4-24 self-tapping screws and 2-56 bolts and nuts are available for mounting straight-thru pin headers of pc boards. Typical applications and part nos. for ordering this hardware are presented below.

Note: 2-56 bolts and nuts may be used to mount pin headers with and without latches. If latches are to be used, the bolts must be positioned in the pin header before the latches are installed.

Note: All part numbers are RoHS compliant.

No. of Positions	Dimensions					Part Number (Without Latches)
	A	B	C	D	E	
10	.700	1.100	1.260	.860	.110 [2.79]	5102160-1
	17.78	27.94	32.00	21.84	.155 [3.94]	5102162-1
14	.900	1.300	1.460	1.060	.110 [2.79]	2-5102160-2*
	22.86	33.02	37.08	26.92	.155 [3.94]	2-5102162-2*
16	1.000	1.400	1.560	1.180	.110 [2.79]	5102160-3
	25.40	35.56	39.62	29.46	.155 [3.94]	—
20	1.200	1.600	1.760	1.360	.110 [2.79]	5102160-4
	30.48	40.64	44.70	34.54	.155 [3.94]	—
24	1.400	1.800	1.960	1.560	.110 [2.79]	5102160-5
	35.56	45.72	49.78	39.62	.155 [3.94]	—
26	1.500	1.900	2.060	1.660	.110 [2.79]	5102160-6
	38.10	48.26	52.32	42.16	.155 [3.94]	2-5102162-6*
34	1.900	2.300	2.460	2.060	.110 [2.79]	5102160-8
	48.26	58.42	62.48	52.32	.155 [3.94]	5102162-8
40	2.200	2.600	2.760	2.360	.110 [2.79]	5102160-9
	55.88	66.04	70.10	59.94	.155 [3.94]	—
50	2.700	3.100	3.260	2.860	.110 [2.79]	1-5102160-0
	68.58	78.74	82.80	72.64	.155 [3.94]	1-5102162-0

Notes: 1. Pin headers in 10- and 14-position sizes have only one slot for snap-in polarizer (military polarization), located as shown.
2. Pin headers in 10-position size have only slot for dual polarization, located as shown.

*Blue housing.

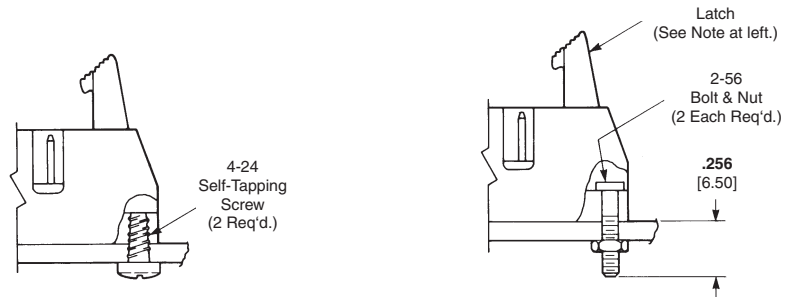

Pin Header Mounting using 4-24 Self-Tapping Screws:
Part No. 19156-1 (for .062 [1.57] Thick PC Board)
19156-2 (for .093 [2.36] Thick PC Board)
19156-3 (for .125 [3.18] Thick PC Board)

Pin Header Mounting with 2-56 Bolts and Nuts:
Part No. 746383-1 (Bolt Only)
Kit No. 102198-1 (Bolt and Nut, 2 Each per Kit)

**AMPMODU Stacking Connectors—Shrouded,
.025 x .025 [0.64 x 0.64] Posts**

Product Facts

- Parallel PC board stacking without use of mother boards
- Provides space between boards for interference-free routing of wire-to-board connections
- Two header heights available: .785 [19.94] and 1.200 [30.48]
- Vertical mount headers are fully shrouded
- Receptacle contacts have dual cantilever beams with built-in overstress protection
- .025 [0.64] sq. posts and receptacle contacts on double-row, .100 x .100 [2.54 x 2.54] centers
- Header posts and receptacle contacts are phosphor bronze, duplex plated
- Housings are made of flame retardant, glass-filled thermoplastic



AMPMODU stacking connectors are a two-piece interconnection system designed for parallel stacking printed circuit boards, without the use of mother boards.

Vertical mount headers and receptacle assemblies feature duplex plated posts and receptacle contacts on a double-row, .100 x .100 [2.54 x 2.54] grid. The .025 [0.64] sq. header posts are more protected, and the top-entry receptacle contacts utilize the proven

AMPMODU receptacle contact design; dual cantilever beams with built-in overstress protection.

Headers are available in two heights: .785 [19.94] and 1.200 [30.48]. This allows the customer to use the height of the header to keep wire-to-board connections up and away from other board components, particularly if the components are densely packaged around the header.

Receptacle Assemblies, Double-Row Board Mounted

Vertical Mount, Top Entry, High Profile, Selectively Loaded (with Standoffs)

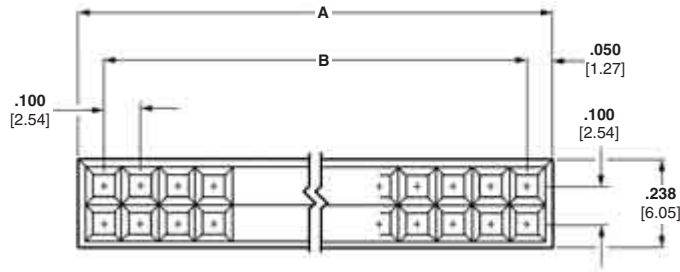

Material and Finish

Housing — Glass-filled thermoplastic, black, 94V-0 rated

Contacts — Phosphor bronze, plated .000010 [0.000254] min. gold on mating area, .000150-.000300 [0.00381-0.00762] matte tin on solder area, with entire contact underplated .000050-.000100 [0.00127-0.00254] nickel

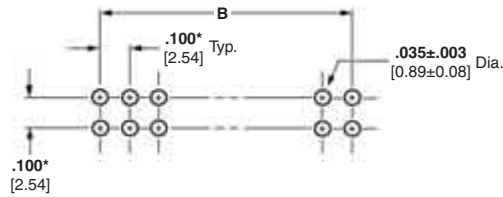
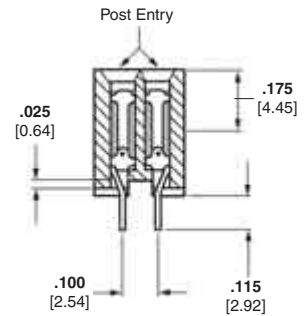
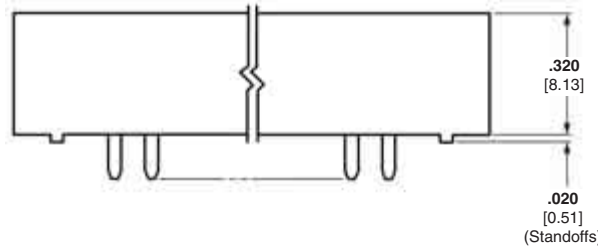

Recommended PC Board Hole Layout

*±.003 [±0.08] tolerances not to accumulate within one connector pattern.

No. of Pos.	Dimensions		Receptacle Assembly Part No.
	A	B	
48* (40 Active)	2.400 [60.96]	2.300 [58.42]	5-102766-1
60* (52 Active)	3.000 [76.2]	2.900 [73.66]	5-102766-4

*In addition to the *active* positions, each receptacle has four cavities on each end that are not loaded with contacts. These empty cavities aid in aligning the receptacle with header posts during mating.

- Notes:**
1. Part no. and date code stamped on housing where size permits.
 2. These receptacle assemblies mate with headers of the same size as the *active* positions listed above. Refer to pages 143 and 144.

Note: All part numbers are RoHS compliant.

Headers, Double-Row, .785 [19.94] Height

**.025 x .025 [0.64 x 0.64]
Straight Post (with
Pin Protection)**



Material and Finish

Housing — Glass-filled thermoplastic, black, 94V-0 rated

Contacts — Phosphor bronze, plated .000015 [0.000381] min. gold on mating area, .000100-.000200 [0.00254-.00508] matte tin on solder area, with entire post underplated .000050 [0.00127] nickel

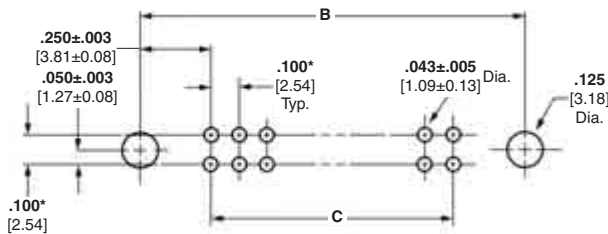
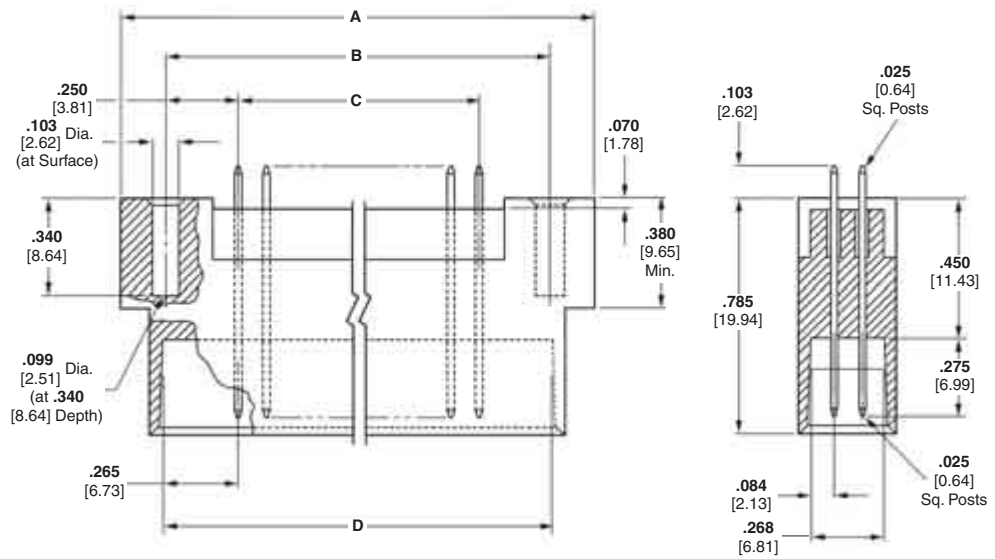
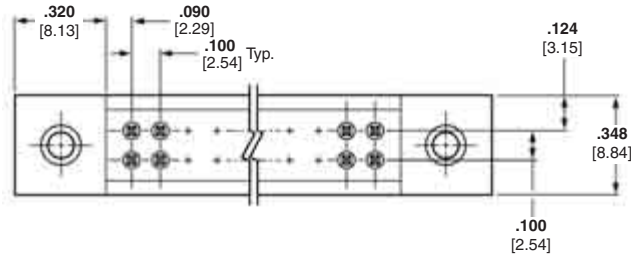

Recommended PC Board Hole Layout

*±.003 [±0.08] tolerances not to accumulate within one connector pattern.

No. of Pos.	Dimensions				Header Part No.
	A	B	C	D	
40	2.720 [69.09]	2.400 [60.96]	1.900 [48.26]	2.430 [61.27]	5-102871-2
52	3.320 [84.33]	3.000 [76.2]	2.500 [63.5]	3.030 [76.96]	5-102871-1

Note: These headers mate with receptacle assemblies having the same number of active positions. See page 142.

Note: All part numbers are RoHS compliant.

Headers, Double-Row, 1.200 [30.48] Height

**.025 x .025 [0.64 x 0.64]
Straight Post (with
Pin Protection)**

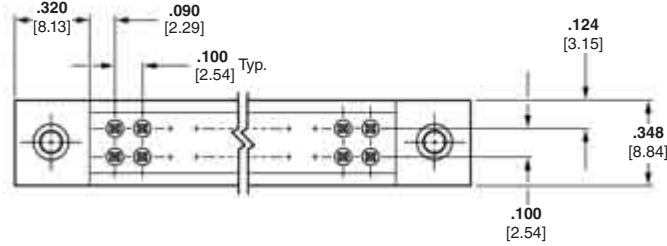

Material and Finish

Housing — Glass-filled thermoplastic, black, 94V-0 rated

Contacts — Phosphor bronze, plated .000015 [0.000381] min. gold on mating area, .000100-.000200 [0.00254-0.00508] matte tin on solder area, with entire post underplated .000050 [0.00127] nickel

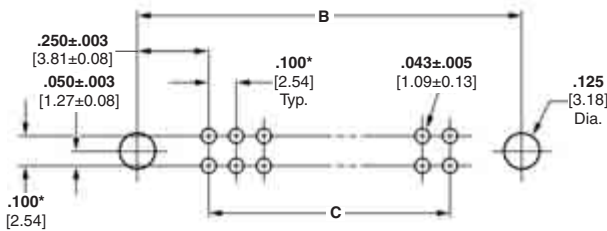
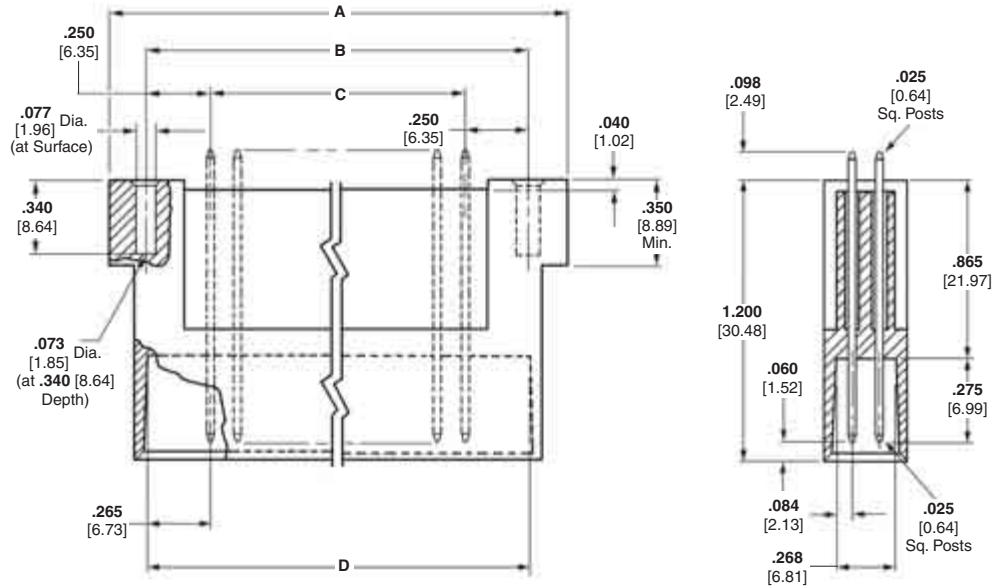

Recommended PC Board Hole Layout

*±.003 [±0.08] tolerances not to accumulate within one connector pattern.



No. of Pos.	Dimensions				Header Part No.
	A	B	C	D	
52	3.320 [84.33]	3.000 [76.2]	2.500 [63.5]	3.030 [76.96]	5-102826-1

Note: This header mates with receptacle assembly having the same number of active positions. See page 142.

Note: All part numbers are RoHS compliant.

ACTION PIN Headers—Shrouded and Unshrouded

Product Facts

- Straight posted unshrouded and shrouded versions
- .025 [0.64] square ACTION PIN posts
- ACTION PIN posts make a gas-tight, press-fit connection in plated-through holes
- Designed not to damage plated-through holes
- Unshrouded headers available in selected sizes 1 through 40 positions (single-row) and 4 through 80 positions (double-row)
- Shrouded headers (double-row) available in selected sizes of 6 through 60 positions
- Flame retardant, black thermoplastic housings, 94V-0 rated
- .100 [2.54] Centerline spacing
- Recognized under the Component Program of Underwriters Laboratories Inc.,  File No. E28476
- Certified by Canadian Standards Association,  File No. LR 16455

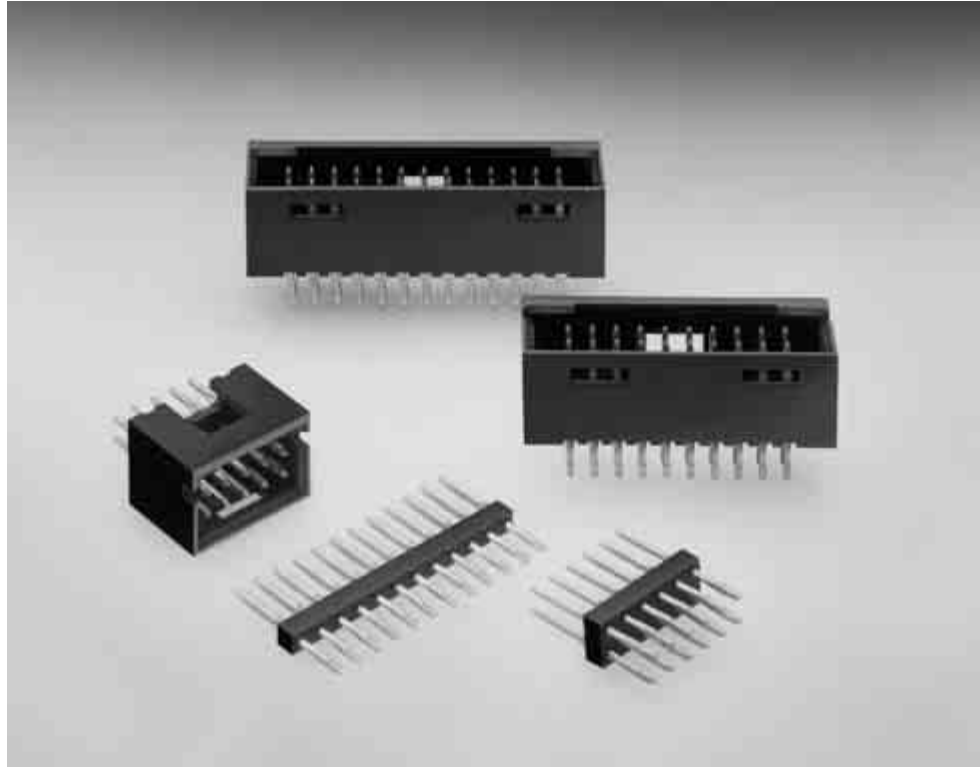

**ACTION PIN Headers—Unshrouded, Single-Row,
.100 [2.54] Centerline**

**.025 [0.64] Square
Straight Post**

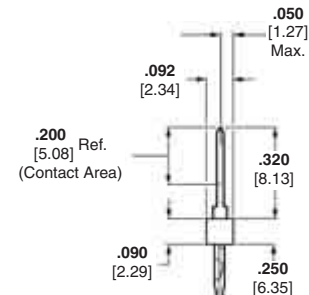
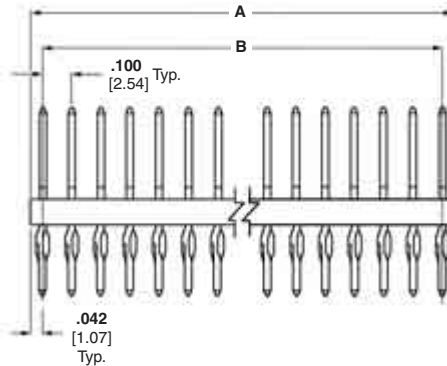

Material and Finish

Housing — Black thermoplastic, 94V-0 rated

Posts — Copper alloy, duplex plated .000030 [0.00076] gold on contact area, .000100-.000200 [0.00254-0.00508] matte tin on termination end, with entire post underplated .000050 [0.00127] nickel

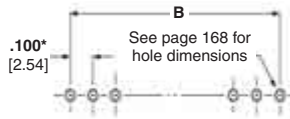

Recommended PC Board Hole Layout
*±.003 [±0.08] tolerances not to accumulate within one connector pattern.

Related Product Data

Mateable Connectors —

Refer to the Mating Post Selection Guide — page 90

ACTION PIN Posts — pages 150, 151

Application Tooling — page 152

Technical Documents — page 276

See mating connector for applicable product and application specifications

No. of Pos.	Dimensions		Part Nos.	
	A	B	For .062 [1.57] Thick PC Boards	For .093-.125 [2.36-3.18] Thick PC Boards
1	.084 [2.13]	—	8-103336-5	8-102898-5
2	.184 [4.67]	.100 [2.54]	8-103336-4	8-102898-4
3	.284 [7.21]	.200 [5.08]	9-103336-0	9-102898-0
4	.384 [9.75]	.300 [7.62]	8-103336-6	8-102898-6
5	.484 [12.29]	.400 [10.16]	8-103336-8	8-102898-8
6	.584 [14.83]	.500 [12.70]	8-103336-7	8-102898-7
7	.684 [17.37]	.600 [15.24]	8-103336-9	8-102898-9
8	.784 [19.91]	.700 [17.78]	5-103336-1	5-102898-1
9	.884 [22.45]	.800 [20.32]	5-103336-2	5-102898-2
10	.984 [24.99]	.900 [22.86]	5-103336-3	5-102898-3
11	1.084 [27.53]	1.000 [25.40]	5-103336-4	5-102898-4
12	1.184 [30.07]	1.100 [27.94]	5-103336-5	5-102898-5
13	1.284 [32.61]	1.200 [30.48]	5-103336-6	5-102898-6
14	1.384 [35.15]	1.300 [33.02]	5-103336-7	5-102898-7
15	1.484 [37.69]	1.400 [35.56]	5-103336-8	5-102898-8
16	1.584 [40.23]	1.500 [38.10]	5-103336-9	5-102898-9
17	1.684 [42.77]	1.600 [40.64]	6-103336-0	6-102898-0
18	1.784 [45.31]	1.700 [43.18]	6-103336-1	6-102898-1
19	1.884 [47.85]	1.800 [45.72]	6-103336-2	6-102898-2
20	1.984 [50.39]	1.900 [48.26]	6-103336-3	6-102898-3
21	2.084 [52.93]	2.000 [50.80]	—	6-102898-4
22	2.184 [55.47]	2.100 [53.34]	—	6-102898-5
23	2.284 [58.01]	2.200 [55.88]	—	6-102898-6
24	2.384 [60.55]	2.300 [58.42]	—	6-102898-7
25	2.484 [63.09]	2.400 [60.96]	6-103336-8	6-102898-8
26	2.584 [65.63]	2.500 [63.50]	—	6-102898-9
27	2.684 [68.17]	2.600 [66.04]	—	7-102898-0
28	2.784 [70.71]	2.700 [68.58]	—	7-102898-1
29	2.884 [73.25]	2.800 [71.12]	—	7-102898-2
30	2.984 [75.79]	2.900 [73.66]	7-103336-3	7-102898-3
32	3.184 [80.87]	3.100 [78.74]	7-103336-5	7-102898-5
36	3.584 [91.03]	3.500 [88.90]	7-103336-9	7-102898-9
40	3.984 [101.19]	3.900 [99.06]	8-103336-3	8-102898-3

Note: To insert header into PC board, use seating tool with arbor tool or air powered machine—page 152.

Note: All part numbers are RoHS compliant.

ACTION PIN Headers—Unshrouded, Double-Row, .100 x .100 [2.54 x 2.54] Centerline

.025 [0.64] Square Straight Post

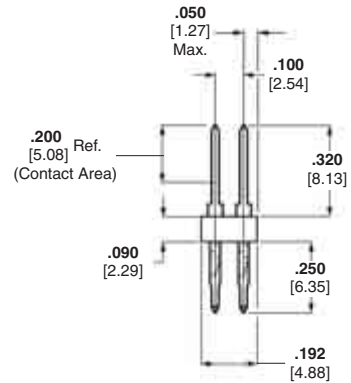
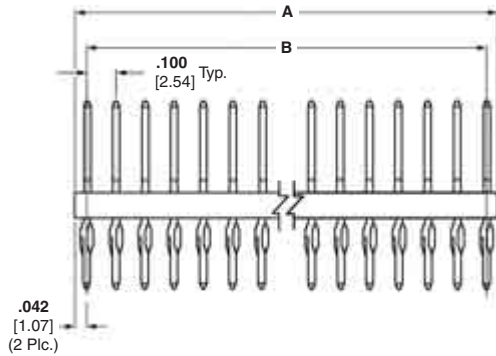
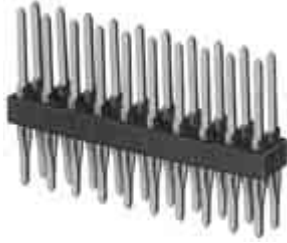

Material and Finish

Housing — Black thermoplastic, 94V-0 rated

Posts — Copper alloy, duplex plated .000030 [0.00076] gold on contact area, .000100-.000200 [0.00254-0.00508] matte tin on termination end, with entire post underplated .000050 [0.00127] nickel

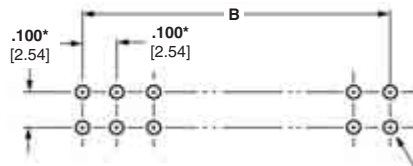

See page 151 for hole dimensions

Recommended PC Board Hole Layout

*±.003 [±0.08] tolerances not to accumulate within one connector pattern.

Related Product Data

Mateable Connectors — Refer to the Mating Post Selection Guide — page 90

ACTION PIN Posts — pages 150, 151

Application Tooling — page 152

Accessories

Barrier Insert — page 204

Technical Documents — page 276

See mating connector for applicable product and application specifications

No. of Pos.	Dimensions		Part Nos.	
	A	B	For .062 [1.57] Thick PC Boards	For .093-.125 [.236-3.18] Thick PC Boards
4	.184 [4.67]	.100 [2.54]	5-103542-1	5-103233-1
6	.284 [7.21]	.200 [5.08]	5-103542-2	5-103233-2
8	.384 [9.75]	.300 [7.62]	5-103542-3	5-103233-3
10	.484 [12.29]	.400 [10.16]	5-103542-4	5-103233-4
12	.584 [14.83]	.500 [12.70]	5-103542-5	5-103233-5
14	.684 [17.37]	.600 [15.24]	5-103542-6	5-103233-6
16	.784 [19.91]	.700 [17.78]	5-103542-7	5-103233-7
18	.884 [22.45]	.800 [20.32]	5-103542-8	5-103233-8
20	.984 [24.99]	.900 [22.86]	5-103542-9	5-103233-9
22	1.084 [27.53]	1.000 [25.40]	6-103542-0	6-103233-0
24	1.184 [30.07]	1.100 [27.94]	6-103542-1	6-103233-1
26	1.284 [32.61]	1.200 [30.48]	6-103542-2	6-103233-2
28	1.384 [35.15]	1.300 [33.02]	6-103542-3	6-103233-3
30	1.484 [37.69]	1.400 [35.56]	6-103542-4	6-103233-4
32	1.584 [40.23]	1.500 [38.10]	6-103542-5	6-103233-5
34	1.684 [42.77]	1.600 [40.64]	6-103542-6	6-103233-6
36	1.784 [45.31]	1.700 [43.18]	6-103542-7	6-103233-7
38	1.884 [47.85]	1.800 [45.72]	6-103542-8	6-103233-8
40	1.984 [50.39]	1.900 [48.26]	6-103542-9	6-103233-9
42	2.084 [52.93]	2.000 [50.80]	7-103542-0	7-103233-0
46	2.284 [58.01]	2.200 [55.88]	7-103542-2	—
50	2.484 [63.09]	2.400 [60.96]	7-103542-4	7-103233-4
60	2.984 [75.79]	2.900 [73.66]	7-103542-9	7-103233-9
66	3.284 [83.41]	3.200 [81.28]	8-103542-2	—
80	3.984 [101.19]	3.900 [99.06]	8-103542-9	8-103233-9

Note: All part numbers are RoHS compliant.

ACTION PIN Headers—Shrouded with .066 [1.68] End Dimension, Double-Row, .100 x .100 [2.54 x 2.54] Centerline

.025 [0.64] Square Straight Post (with Detent Windows, for .093-.125 [.236-3.18] Thick PC Board)

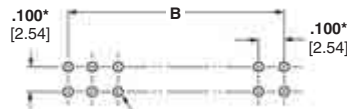
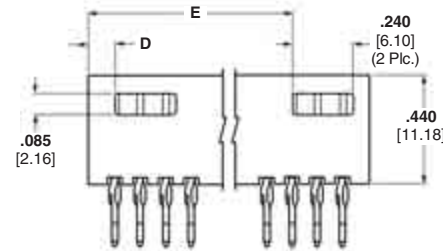
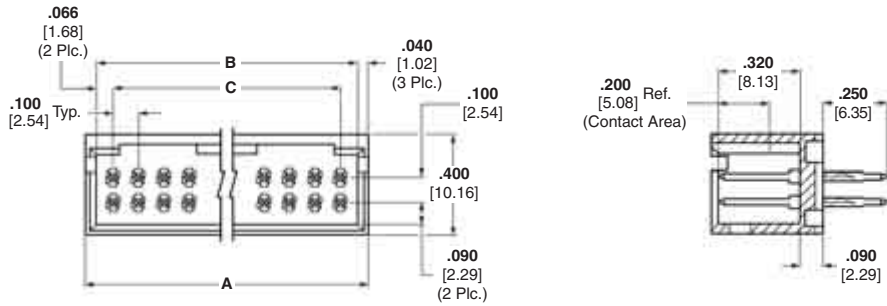

See page 151 for hole dimensions

Recommended PC Board Hole Layout

*±.003 [±0.08] tolerances not to accumulate within one connector pattern.

Material and Finish

Housing — Black thermoplastic, 94V-0 rated

Posts — Copper alloy, duplex plated .000030 [0.00076] gold on contact area, .000100-.000200 [0.00254-0.00508] matte tin on termination end, with entire post underplated .000050 [0.00127] nickel

Related Product Data

Mateable Connectors —

AMPMODU Board Mount Receptacles — pages 176, 179, 180

AMPMODU Wire-Applied Receptacles — pages 217-219

AMPMODU MT Receptacles — pages 256, 257

ACTION PIN Posts — pages 150, 151

Application Tooling — page 152

Accessories

Barrier Insert — page 204

Technical Documents — page 276

See mating connector for applicable product and application specifications

No. of Pos.	Dimensions					Header Part Nos.
	A	B	C	D	E	
6	.412 [10.46]	.332 [8.43]	.200 [5.08]	.106 [2.69]	—	5-102699-2
8	.512 [13.00]	.432 [10.97]	.300 [7.62]	.106 [2.69]	—	5-102699-3
10	.612 [15.54]	.532 [13.51]	.400 [10.16]	.206 [5.23]	—	5-102699-4
12	.712 [18.08]	.632 [16.05]	.500 [12.70]	.206 [5.23]	—	5-102699-5
14	.812 [20.62]	.732 [18.59]	.600 [15.24]	.306 [7.77]	—	5-102699-6
16	.912 [23.16]	.832 [21.13]	.700 [17.78]	.306 [7.77]	—	5-102699-7
18	1.012 [25.70]	.932 [23.67]	.800 [20.32]	.406 [10.31]	—	5-102699-8
20	1.112 [28.24]	1.032 [26.21]	.900 [22.86]	.106 [2.69]	.806 [20.47]	5-102699-9
26	1.412 [35.86]	1.332 [33.83]	1.200 [30.48]	.106 [2.69]	1.106 [28.09]	6-102699-2
30	1.612 [40.94]	1.532 [38.91]	1.400 [35.56]	.106 [2.69]	1.306 [33.17]	6-102699-4
34	1.812 [46.02]	1.732 [43.99]	1.600 [40.64]	.106 [2.69]	1.506 [38.25]	6-102699-6
40	2.112 [53.64]	2.032 [51.61]	1.900 [48.26]	.106 [2.69]	1.806 [45.87]	6-102699-9
50	2.612 [66.34]	2.532 [64.31]	2.400 [60.96]	.106 [2.69]	2.306 [58.57]	7-102699-3
60	3.112 [79.04]	3.032 [77.01]	2.900 [73.66]	.106 [2.69]	2.806 [71.27]	7-102699-8

Note: All part numbers are RoHS compliant.

ACTION PIN Headers—Shrouded with .150 [3.81] End Dimension, Double-Row, .100 x .100 [2.54 x 2.54] Centerline

.025 [0.64] Square Straight Post (with Detent Windows, for .093-.125 [.236-3.18] Thick PC Board)



Material and Finish

Housing — Black thermoplastic, 94V-0 rated

Posts — Copper alloy, duplex plated .000030 [0.00076] gold on contact area, .000100-.000200 [0.00254-0.00508] matte tin on termination end, with entire post underplated .000050 [0.00127] nickel

Related Product Data

Mateable Connectors —

AMPMODU MTE Receptacles — pages 232, 233

ACTION PIN Posts — pages 150, 151

Application Tooling — page 152

Accessories

Barrier Insert — page 204

Technical Documents — page 276

See mating connector for applicable product and application specifications

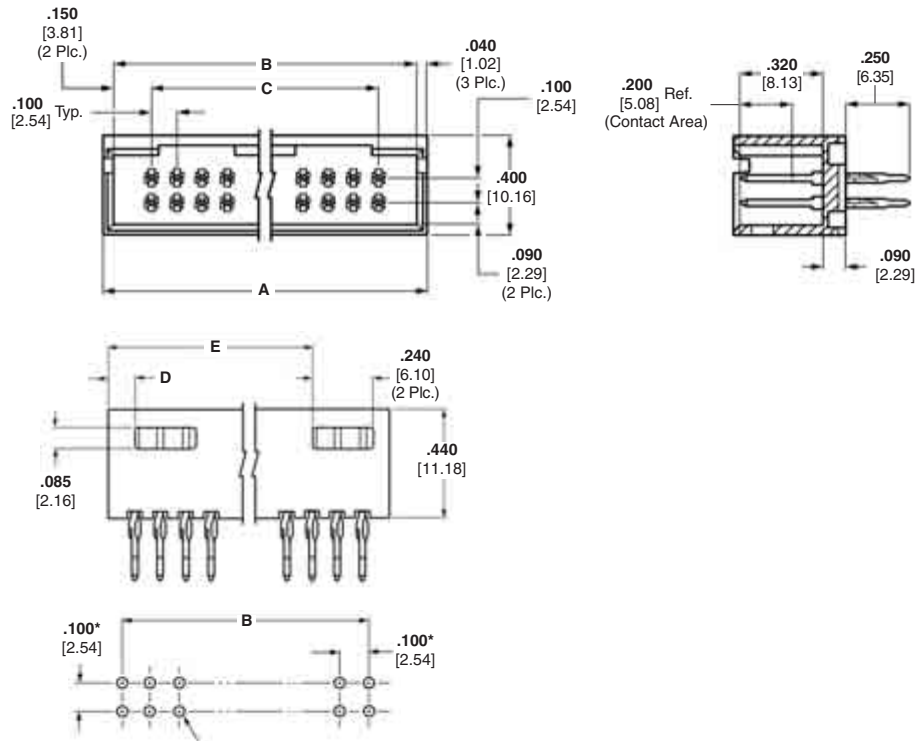

See page 151 for hole dimensions

Recommended PC Board Hole Layout

*±.003 [±0.08] tolerances not to accumulate within one connector pattern.

No. of Pos.	Dimensions					Header Part Nos.
	A	B	C	D	E	
6	.580 [14.73]	.500 [8.43]	.200 [5.08]	.190 [4.83]	—	6-102557-0
8	.680 [17.27]	.600 [10.97]	.300 [7.62]	.190 [4.83]	—	6-102557-1
10	.780 [19.81]	.700 [17.78]	.400 [10.16]	.290 [7.37]	—	5-102557-9
12	.880 [22.35]	.800 [20.32]	.500 [12.70]	.290 [7.37]	—	6-102557-2
14	.980 [24.89]	.900 [22.86]	.600 [15.24]	.390 [9.91]	—	6-102557-3
16	1.080 [27.43]	1.000 [25.40]	.700 [17.78]	.390 [9.91]	—	6-102557-4
18	1.180 [29.97]	1.100 [27.94]	.800 [20.32]	.490 [10.31]	—	6-102557-5
20	1.280 [32.51]	1.200 [30.48]	.900 [22.86]	.190 [4.83]	.890 [22.61]	5-102557-2
24	1.480 [37.59]	1.400 [35.56]	1.100 [27.94]	.190 [4.83]	1.090 [27.69]	6-102557-7
26	1.580 [40.13]	1.500 [38.10]	1.200 [30.48]	.190 [4.83]	1.190 [30.23]	5-102557-3
30	1.780 [45.21]	1.700 [43.18]	1.400 [35.56]	.190 [4.83]	1.390 [35.31]	5-102557-4
34	1.980 [50.29]	1.900 [48.26]	1.600 [40.64]	.190 [4.83]	1.590 [40.39]	5-102557-5
40	2.280 [57.91]	2.200 [55.88]	1.900 [48.26]	.190 [4.83]	1.890 [48.01]	5-102557-1
50	2.780 [70.61]	2.700 [68.58]	2.400 [60.96]	.190 [4.83]	2.390 [60.71]	5-102557-6
60	3.280 [83.31]	3.200 [81.28]	2.900 [73.66]	.190 [4.83]	2.890 [73.41]	5-102557-7

Note: All part numbers are RoHS compliant.

ACTION PIN Press-Fit Posts

The Reliable Plated-Through Hole Interconnect

Solderless interconnections have been popular in electrical and electronic applications with world-wide success for decades. They provide reliable electrical and mechanical stability and offer applied-cost savings across the board. For PC board applications, compliant ACTION PIN posts provide these features:

- Large gas-tight contact zone
- High reliability due to stored energy
- More resistant to damage to plated-through holes during installation
- Especially suited for multilayer PC boards
- Less costly board manufacturing due to larger hole tolerances compared to use of solid pins
- Application can be made by end-user
- Repairability—contact can be replaced in the same pin location (two repairs)
- Installation with no heat cycling of board
- Permits mass insertion by minimizing forces needed to insert pins as compared to solid pin press-fit application
- Significant applied-cost savings in many applications

Since compliant ACTION PIN posts do not have to be soldered, problems associated with solder are eliminated, such as:

- Faulty solder joints
- Solder fumes; contaminants are deposited on the contacts
- Solder spots; short circuits between printed circuits
- Flux residuals
- Thermal strain on printed circuit boards and components
- Degassing of plated-through holes

Solderless press-fit interconnections using compliant pins are primarily integrated in, but not limited to, backplanes.

Solderless press-fit interconnections are used in racks, especially where connectors must be fixed on the solder side of the PC board and/or component side. In these applications, the holes for ACTION PIN post connectors are covered during the soldering process and press-fitting is performed after soldering.

Other applications for ACTION PIN post interconnections include PC boards that incorporate components using surface mount technology (SMT). Here, too, press-fit interconnections can be applied after soldering, thus eliminating complications associated with connectors suitable for surface mounting.



Principle of the Compliant ACTION PIN Post

When a compliant ACTION PIN post is inserted into a plated-through hole, two spring members are compressed, exerting force against the hole for a gas-tight connection. The diameter of the hole is smaller than the diagonal size of the pin (see cross-section illustration below).

The beam characteristics of the pin are designed so that a plastic, as well as an elastic, deformation takes place during insertion. The two spring members compress to different degrees to accommodate hole tolerances. The compliant pin also reduces strain on the board. With a rigid pin, the elastic strain energy is stored entirely in the board, leading to damage of the plated-through holes. With the compliant ACTION PIN post, the residual force of the elastic deformation maintains stored energy to produce a tight contact zone between the pin and the plated-through hole. This maintains long-term electrical and mechanical reliability of the interconnection.

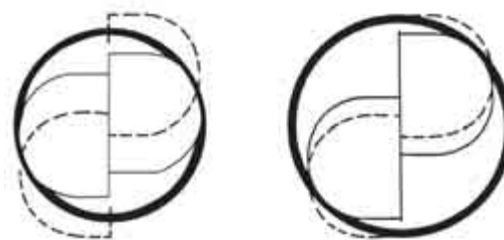

**Minimum
Hole Dia.**
.037 [0.94]

**Maximum
Hole Dia.**
.043 [1.09]

Cross-Section Area of ACTION PIN Press-Fit Post in Printed Circuit Board Holes

ACTION PIN Press-Fit Posts (Continued)



ACTION PIN posts provide a more reliable press-fit connection. Localized pressure in the interface area provides oxide break-through and prevents corrosion better in many of the harshest environments to help provide a reliable connection. Also, radial and axial distortion are controlled to meet today's standards for multilayer board applications.

PC Board Thickness

ACTION PIN posts are designed for use in a variety of PC board thicknesses. However, certain ACTION PIN posts are to be used in specific ranges of board thicknesses. To promote optimum performance, the recommended board thicknesses provided with the connector being used must be followed.



- ① Annular Ring (See Note)
- ② Drilled Hole
- ③ Copper Thickness
- ④ Tin-lead Thickness
- ⑤ Plated-Through Hole

ACTION PIN Post/PC Board Applications

ACTION PIN Contact Material Thickness	Drilled Hole Diameter [®]	Plating Thicknesses		Plated-Through Hole Diameter [®]	Distortion Specification*	
		Copper ^{®*}	Tin-lead [®]		Average	Maximum
.025 [0.64]	.0453 ^{+0.001} [1.151 ^{+0.03}]	.001-.003 [0.03-0.08]	.0003 [0.008]Min.	.037-.043 [0.94-1.09]	.0015 [0.038]	.002 [0.05]

*Maximum hardness of copper layer is 150 Knoop.

**Radial hole distortion.

Note: Recommended annular ring diameter is hole diameter plus .020 [0.51].

Application Tooling for AMPMODU Headers with ACTION PIN Posts

ACTION PIN Post Replacement Tooling



Rear Insertion/Extraction Tool
No. 265871-7 (Ref. 408-2636)

Includes:

- Impact Tool No. 380392-8
- Removal Tool No. 265964-1
- Replacement Tip No. 308554-1

Single-Row Connector Seating Tools

Tooling Assembly No. 91171-1 is used to install single-row AMPMODU headers with ACTION PIN posts into PC boards.

Pin headers with ACTION PIN posts allow high speed, solderless back-plane construction through press-fit application. Press fitting connectors to printed circuit boards requires special seating tools which transfer application force directly to the contacts.

Force applied to the tool to seat the connectors can be provided by the Tyco Electronics seating machines shown on this page.

For tooling information, call the Tyco Electronics Automation Group 1-800-722-1111.

Double-Row Connector Seating Tools

Header Size (No. of Pos.)	Tool Assembly No.
4	91170-1
6	91170-1
8	91170-2
12	91170-5
14	91170-6
16	91170-7
20	91170-9
24	1-91170-1
30	1-91170-4
36	1-91170-7
40	1-91170-9
50	2-91170-4
60	2-91170-9
80	3-91170-2
96	3-91170-5
100	3-91170-6
120	3-91170-8
140	4-91170-0
200	4-91170-2

Triple-Row Connector Seating Tools

Header Size (No. of Pos.)	Tool Assembly No.
96	91169-8
105	91169-6
120	91169-7
150	91169-3
195	91169-2
204	91169-1
210	91169-5
300	91169-9

Application Tooling for ACTION PIN Posts

5



BMEP 5T



AEP 6T

ASG Servo Electric Presses

Tyco Electronics offers a wide range of servo-electric presses for the application of press-fit connectors. Systems are available with varying force capacity, board size capacity and process capability. Each system features real-time force feedback and PC control to allow the highest level of control and traceability. Every connector pressed is

monitored to confirm that maximum force is not exceeded and minimum force is met. Each system controls force, height and speed to allow termination of the pressing cycle by force or height parameters. Complete SPC data is available as each connector press cycle is monitored and stored.

Please see the matrix below and contact Tyco Electronics Automation Group at 1-800-722-1111 for assistance in understanding which system will best meet your needs.

Press Model	Description	Max Pressing Force tons [kN]	Max Board Size (L x W) in [mm]
BMEP 3T	Semi-automatic, benchtop servo-electric press	3 [26.7]	18 x 24 [460 x 610]
BMEP 5T	Semi-automatic, benchtop servo-electric press	5 [44.5]	18 x 24 [460 x 610]
MEP 6T	Semi-automatic, stand-alone servo-electric press	6 [53.4]	24 x 36 [610 x 914]
MEP 12T	Semi-automatic, stand-alone servo-electric press	12 [106.8]	30 x 36 [762 x 914]
AEP 12T	Automatic, inline servo-electric press	12 [106.8]	36 x 48 [914 x 1219]
AEP 6T	Automatic, stand alone servo-electric press	6 [53.4]	30 x 36 [762 x 914]

Note: All part numbers are RoHS compliant.

Application Tooling for Post Insertion

Tyco Electronics offers a wide range of application tooling solutions ranging from stand alone manual insertion systems through fully automatic inline systems. Please contact your local Tyco Electronics representative or the Tyco Electronics Tooling Assistance Center at 1-800-722-1111 for help in finding the right solution to meet your particular requirements.

Modular Insertion System Bench Machine No. 217600-1

This machine uses Tyco Electronics insertion heads to install a variety of printed circuit board products at rates of 2,000 per hour. The printed circuit board is placed in a Board Holding Fixture which is attached to a two-hand controlled mechanism. The operator moves the board over the machine anvil; a switch in the anvil actuates the machine when the printed circuit board is placed on the anvil. A spotlight illuminates the insertion area.

Consult Tyco Electronics for further information on this machine and the insertion heads.



P300 and P350 Automatic Insertion Machines

The P300 and P350 are automatic insertion machines for the application of reeled compliant pin and thru-hole products. Systems are available as stand alone or fully inline with SMEMA compatible conveyor system. Up to 3 different insertion heads can be mounted on a system allowing one machine to apply up to 3 different products. Insertion rates of up to 3 insertions per second on the P300 and up to 5 insertions per second on a P350 are possible (application dependent). PCBs up to 15.5" x 23.5" [400x600mm] on the P300 and up to 17.5" x 17.5" [450x450mm] on the P350 can be processed by high speed XY positioning tables. A wide range of options, including force monitoring, PCB vision correct, and PCB thickness measurement are available to meet your performance and production flexibility requirements.

Note: All part numbers are RoHS compliant.

ACTION PIN Stacking Connector System (Non-Intermateable with AMPMODU Connectors)

Product Facts

- Can stack multiple printed circuit boards without the need of a mother board
- Connect bus lines in the shortest possible distance
- Receptacle assembly has ACTION PIN posts for solderless board mounting
- Can be mounted onto the board simply by press fitting with Mini-Press
- Receptacle assembly is easy to service and replace (up to 2 times)
- Receptacle contacts are of fork design to mate with posts at two points. Virtually eliminates danger of scooping at mating/unmating
- Stacking dimensions are 13.4 [.528] or 19.0 [.748] when using receptacle assemblies together, and 13.9 [.547] or 19.5 [.768] when using a combination of receptacle and post header assemblies
- Accepts 1.6 [.062] thick boards
- Housing provided with polarization to help prevent mismatching
- Housing made of chemical-resistant glass-filled PBT, black in color
- Contacts are of copper alloy material with high spring characteristics, gold-over-nickel plated
- Post hood available to protect the post portion of receptacle contacts. Can be selected depending on stacking dimensions
- Connectors available in sizes of 26, 30, 34, 40, 50 and 60 positions
- Product specification: 108-5197

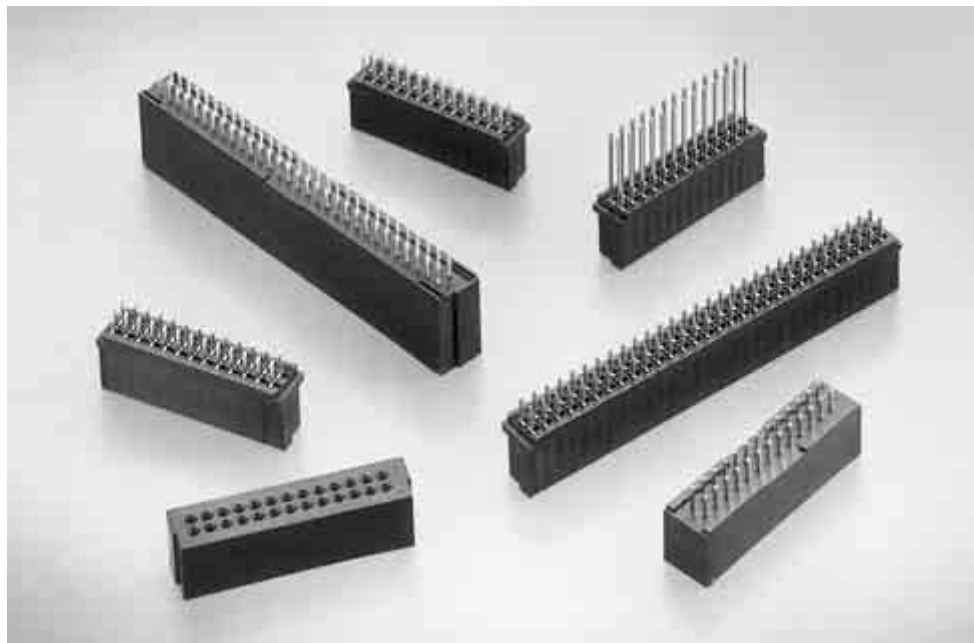

ACTION PIN Stacking Connectors are a family of two-piece connectors used to stack multiple printed circuit boards in parallel. They have been developed to provide a more reliable and economical means of compact wiring and high-density packaging inside a variety of electronic equipment.

The connectors have many advanced features: they can be used to connect

bus lines in the shortest possible distance without the need of a mother board, thus permitting effective utilization of space above the board; compared with other methods of jumper connection using cable connectors, they make the overall board layout more clean and straight for compact packaging.

Contacts are on 2.54 x 2.54 [.100 x .100] grid. The connectors are available in

sizes of 26, 30, 34, 40, 50 and 60 positions. ACTION PIN Stacking Connectors consist of a receptacle assembly, a mating post header and a post hood to protect the post portion of the receptacle assembly.

A complete description of the ACTION PIN Stacking Connectors is presented on the following page (155).

ACTION PIN Stacking Connector System
(Non-Intermateable with AMPMODU Connectors) (Continued)

Receptacle Assembly

The receptacle assembly features reliability and economy characteristic of this product line.

The mating portion of its built-in receptacle contacts is a fork design, highly resilient and helps prevent damage to contacts by scooping at mating/unmating.

On the board mount side of the assembly are 0.55 [.022] square ACTION PIN posts.

No soldering is required to mount the assembly on the board, the posts being simply, press fit into the board's 0.825 [.032] diameter holes.

Two types of receptacle assemblies are available;

one is used with an outermost board and the other with intermediary boards. A solder version is also available for the outer board mount assembly.

Post Hood

When using the intermediary board mount receptacle assembly, this post hood is used to protect the post portion of the assembly. The post hood is available in two types: one with the housing height of 10.0 [.394] and the other with the housing height of 15.7 [.618]. They can be selected, depending on stacking dimensions.

Post Header

The post header is mounted onto the outer board on the other side of the board to

which an outer board mount receptacle assembly is applied. The post header is preloaded with 0.50 [.022] square soldering posts. These posts are protected by the side walls of the housing.

Stacking dimensions provided by this connector line are as follows:

When the outer board receptacle and intermediary board receptacle assemblies are used 13.4 [.528] or 19.0 [.748].

When the intermediary board receptacle assembly and the post header assembly are used 13.9 [.547] or 19.5 [.768].

Typical Application

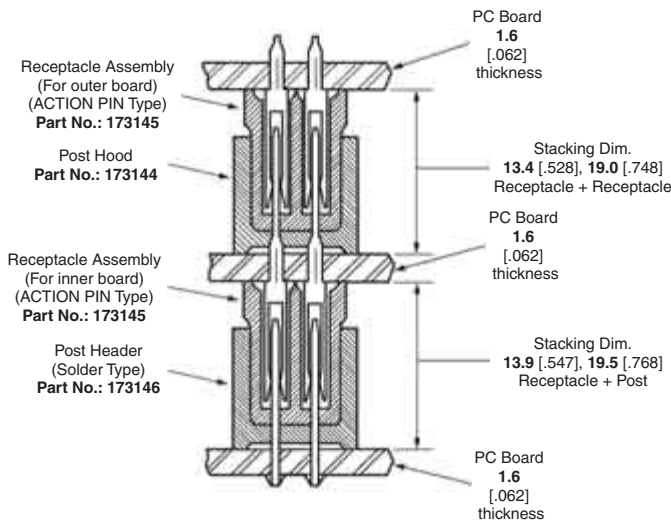

Note: All part numbers are RoHS compliant.

Post Hood (Non-Intermateable with AMPMODU Connectors)



The post hood, mounted onto the post of the intermediary receptacle assembly, protects the post and serves as a header assembly when stacking several boards.

Material

Black glass-filled PBT, 94V-0 rated

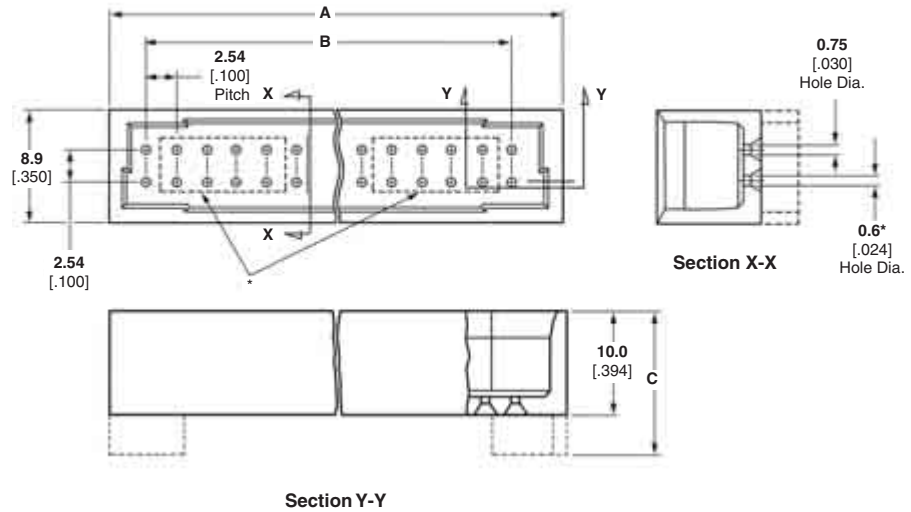

Stacking Connectors, Post Hood

5

Acceptable Post Length	No. of Pos.	Dimensions (See Note.)			Post Hood Part Nos.
		A	B	C	
For 8.9 [.350] or 10.9 [.429] (For Stacking Dimension) 13.4 [.528]	26	38.1 [1.500]	30.48 [1.200]	10.0 [.394]	1-173144-1
	30	43.2 [1.700]	33.56 [1.321]	10.0 [.394]	173144-2
	34	48.3 [1.900]	40.64 [1.600]	10.0 [.394]	1-173144-2
	40	55.9 [2.200]	48.26 [1.900]	10.0 [.394]	173144-3
	50	68.6 [2.700]	65.96 [2.597]	10.0 [.394]	173144-4
	60	81.3 [3.200]	73.66 [2.900]	10.0 [.394]	173144-5
For 14.5 [.571] or 16.5 [.650] (For Stacking Dimension) 19.0 [.748]	26	38.1 [1.500]	30.48 [1.200]	15.6 [.614]	1-173144-3
	30	43.2 [1.700]	33.56 [1.321]	15.6 [.614]	173144-7
	34	48.3 [1.900]	40.64 [1.600]	15.6 [.614]	1-173144-4
	40	55.9 [2.200]	48.26 [1.900]	15.6 [.614]	173144-8
	50	68.6 [2.700]	65.96 [2.597]	15.6 [.614]	3-173144-8*
	60	81.3 [3.200]	73.66 [2.900]	15.6 [.614]	173144-9
					1-173144-0

*0.60 [.024] dia. applies to 16 holes on both sides, except Part No. 3-173144-8.

Note: All part numbers are RoHS compliant.

Receptacle Assembly for Outer Board (With 0.55 [.022] Square Post)



Material and Finish

Housing — Black glass-filled PBT, 94V-0 rated

Contacts — Copper alloy, plated 0.00020 [.000008] gold on contact area and post mating area, gold flash on ACTION PIN tail or 0.000070 [.0000027] tin on solder tail, with entire contact underplated 0.00130 [.000050] nickel

Application Tooling shown on page 162.

PC Board Mounting Dimensions

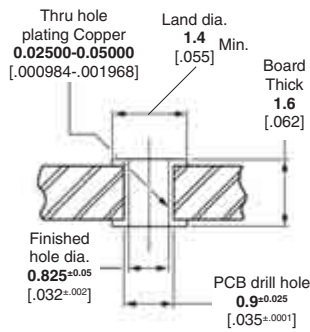

ACTION PIN Post

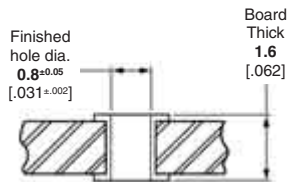

Solder Post

Receptacle Assemblies with ACTION PIN Posts and Solder Posts (Non-Intermateable with AMPMODU Connectors)

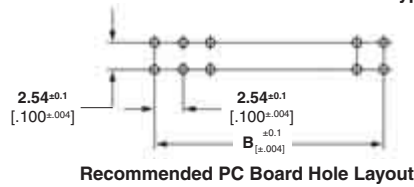
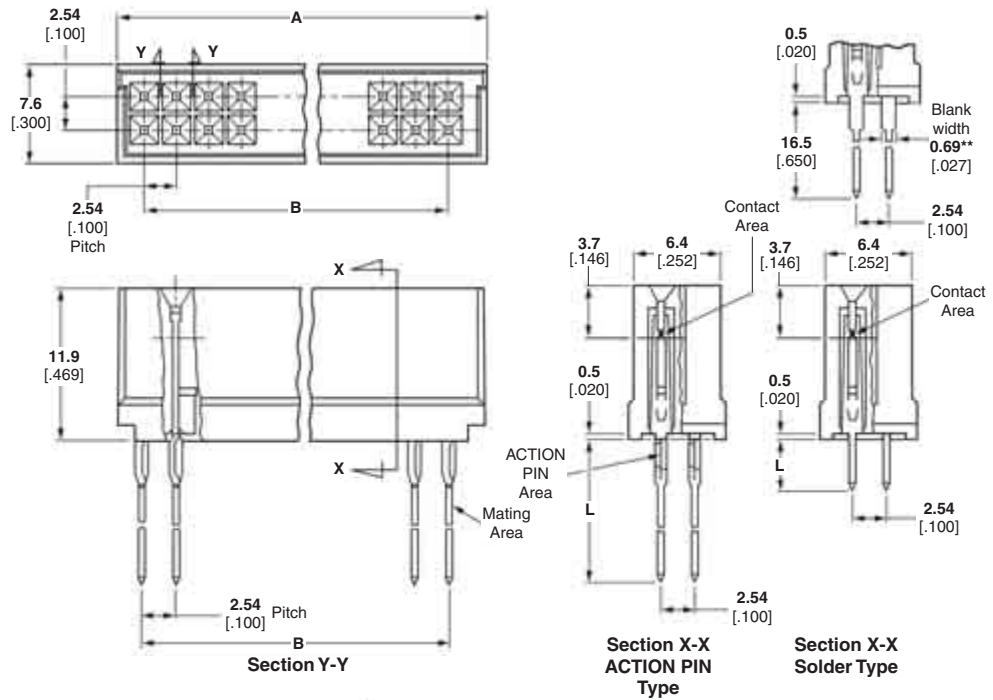

For Outer Board

Type	Post Length L	No. of Pos.	Dimensions (See Note.)		Receptacle Assembly Part Nos.
			A	B	
ACTION PIN Post	4.2*	26	35.6 [1.402]	30.48 [1.200]	1-173145-7
		30	40.6 [1.598]	35.56 [1.400]	173145-2
		34	45.7 [1.799]	40.64 [1.600]	1-173145-8
		40	53.3 [2.098]	48.26 [1.900]	173145-3
		50	66.0 [2.598]	60.96 [2.400]	173145-4
		60	78.7 [3.098]	73.66 [2.900]	173145-5
Solder Post	4.2*	26	35.6 [1.402]	30.48 [1.200]	2-173145-8
		30	40.6 [1.598]	35.56 [1.400]	2-173145-4
		34	45.7 [1.799]	40.64 [1.600]	2-173145-9
		40	53.3 [2.098]	48.26 [1.900]	2-173145-5
		50	66.0 [2.598]	60.96 [2.400]	2-173145-6
		60	78.7 [3.098]	73.66 [2.900]	2-173145-7 3-173145-0**

*After mounted receptacle assembly is on board, dimension of extrude length from board is 2.6 [.102].
**Post Length = 17.0 [.669], Blank Width = 0.69 [.027] (see above figure) (finished hole dia. = 1.0 [.039]).

Note: All part numbers are RoHS compliant.

Receptacle Assembly for Inner Board (With 0.55 [.022] Square Post)



Material and Finish

Housing — Black glass-filled PBT, 94V-0 rated
Contacts — Copper alloy, plated 0.00020 [.000008] gold on contact area and post mating area, gold flash on ACTION PIN tail or 0.000070 [.0000027] tin on solder tail, with entire contact underplated 0.00130 [.000050] nickel

Application Tooling shown on page 162.

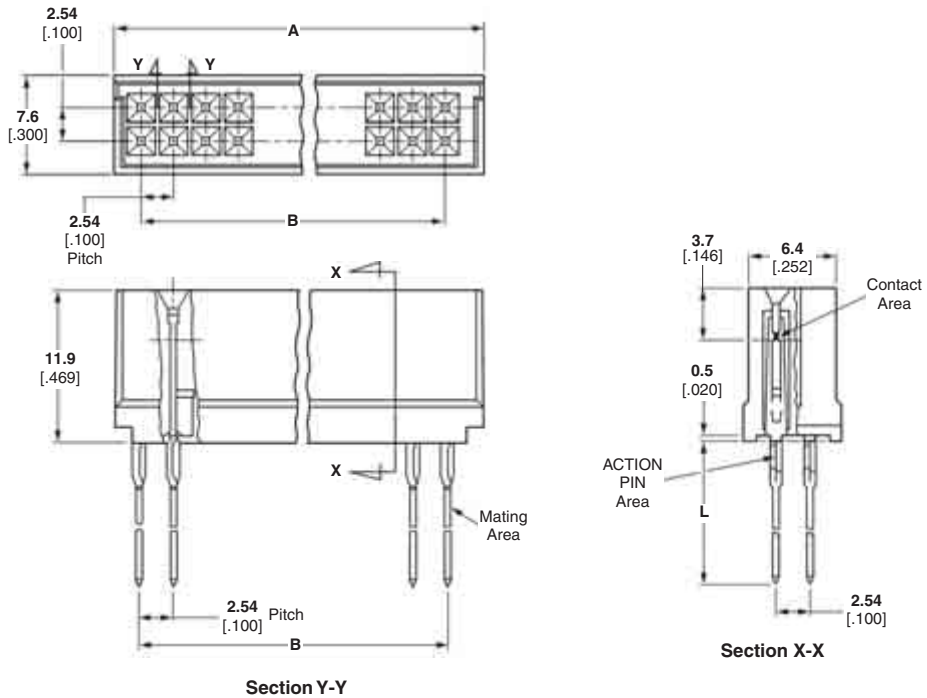

PC Board Mounting Dimensions

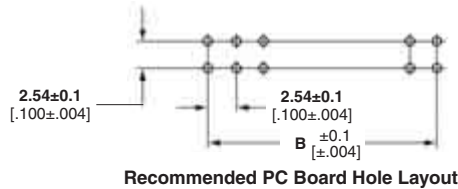
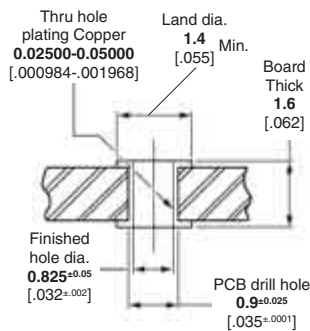

For Inner Board

Stacking Dimensions	Post Length L	No. of Pos.	Dimensions (See Note.)		Receptacle Assembly Part Nos.
			A	B	
13.4 [.528]	8.9 .350	30	40.6 [1.598]	35.56 [1.400]	3-173145-2
		34	45.7 [1.799]	40.64 [1.600]	3-173145-7
		40	53.3 [2.098]	48.26 [1.900]	3-173145-3
		50	66.0 [2.598]	60.96 [2.400]	3-173145-1*
		60	78.7 [3.098]	73.66 [2.900]	3-173145-4
	10.9 .429	26	35.6 [1.402]	30.48 [1.200]	1-173145-9
		30	40.6 [1.598]	35.56 [1.400]	173145-7
		34	45.7 [1.799]	40.64 [1.600]	2-173145-0
		40	53.3 [2.098]	48.26 [1.900]	173145-8
		50	66.0 [2.598]	60.96 [2.400]	173145-9
		60	78.7 [3.098]	73.66 [2.900]	1-173145-0

*Contact area and post mating area: 0.00050 [.000020] min. gold over 0.00130 [.000050] min. nickel plated.

Note: All part numbers are RoHS compliant.

Receptacle Assemblies with ACTION PIN Posts (Non-Intermateable with AMPMODU Connectors) (Continued)

For Inner Board (Continued)

Stacking Dimensions	Post Length L	No. of Pos.	Dimensions (See Note.)		Receptacle Assembly Part Nos.
			A	B	
19.0 [.748]	14.5 [.571]	26	35.6 [1.402]	30.48 [1.200]	4-173145-2
		30	40.6 [1.598]	35.56 [1.400]	3-173145-8
		34	45.7 [1.799]	40.64 [1.600]	4-173145-3
		40	53.3 [2.098]	48.26 [1.900]	3-173145-9
		50	66.0 [2.598]	60.96 [2.400]	4-173145-0
		60	78.7 [3.098]	73.66 [2.900]	4-173145-1
	16.5 [.650]	26	35.6 [1.402]	30.48 [1.200]	2-173145-1
		30	40.6 [1.598]	35.56 [1.400]	1-173145-2
		34	45.7 [1.799]	40.64 [1.600]	2-173145-2
		40	53.3 [2.098]	48.26 [1.900]	1-173145-3
		50	66.0 [2.598]	60.96 [2.400]	1-173145-4
		60	78.7 [3.098]	73.66 [2.900]	1-173145-5

*Contact area and post mating area: 0.00050 [.000020] min. gold over 0.00130 [.000050] min. nickel plated.

Note: All part numbers are RoHS compliant.

Post Headers with Solder Posts (Non-Intermateable with AMPMODU Connectors)

Post Header (With 0.55 [.022] Square Post)

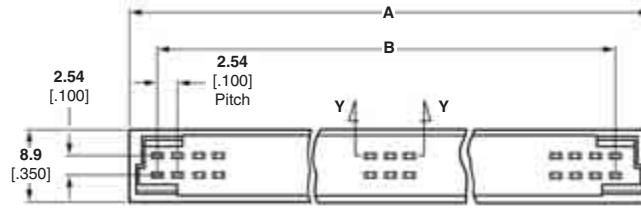
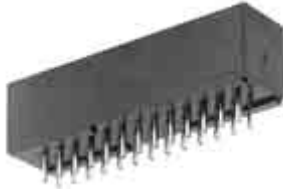

Material and Finish

Housing — Black glass-filled PBT, 94V-0 rated

Posts — Copper alloy, plated 0.00020 [.000008] gold on contact area, 0.000070 [.0000027] min. tin on solder tail, with entire post underplated 0.00130 [.000050] nickel

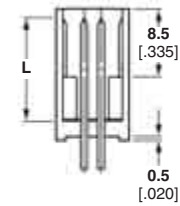
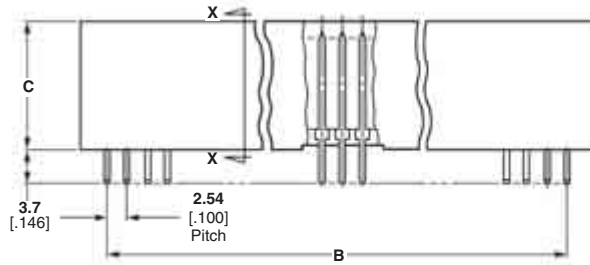

PC Board Mounting Dimensions

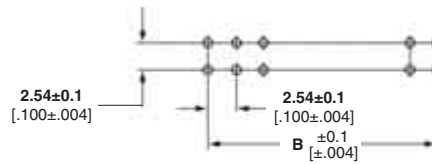
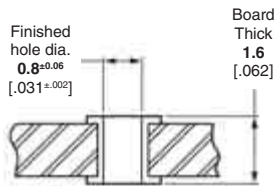

Recommended PC Board Hole Layout

Stacking Dimensions	Post Length L	No. of Pos.	Dimensions (See Note.)			Part Nos. of Post Header Assembly
			A	B	C	
13.9 [.547]	5.8 [.228]	26	38.1 [1.500]	30.48 [1.200]	10.5 [.413]	3-173146-5
		30	43.2 [1.700]	35.56 [1.400]	10.5 [.413]	3-173146-1
		34	48.3 [1.900]	40.64 [1.600]	10.5 [.413]	3-173146-6
		40	55.9 [2.200]	48.26 [1.900]	10.5 [.413]	3-173146-2
		50	68.6 [2.700]	60.96 [2.400]	10.5 [.413]	3-173146-3
		60	81.3 [3.200]	73.66 [2.900]	10.5 [.413]	3-173146-4
	7.8 [.307]	26	38.1 [1.500]	30.48 [1.200]	10.5 [.413]	2-173146-1
		30	43.2 [1.700]	35.56 [1.400]	10.5 [.413]	1-173146-7
		34	48.3 [1.900]	40.64 [1.600]	10.5 [.413]	2-173146-2
		40	55.9 [2.200]	48.26 [1.900]	10.5 [.413]	1-173146-8
		50	68.6 [2.700]	60.96 [2.400]	10.5 [.413]	4-173146-3*
		60	81.3 [3.200]	73.66 [2.900]	10.5 [.413]	1-173146-9
		60	81.3 [3.200]	73.66 [2.900]	10.5 [.413]	2-173146-0

*Contact mating area: 0.00050 [.000020] min. gold over 0.00130 [.000050] min. nickel plated.

Note: All part numbers are RoHS compliant.

**Post Headers with Solder Posts
(Non-Intermateable with AMPMODU Connectors)** (Continued)

Stacking Dimensions	Post Length L	No. of Pos.	Dimensions (See Note.)			Part Nos. of Post Header Assembly
			A	B	C	
19.5 [.768]	11.4 [.449]	26	38.1 [1.500]	30.48 [1.200]	16.1 [.634]	4-173146-1
		30	43.2 [1.700]	35.56 [1.400]	16.1 [.634]	3-173146-7
		34	48.3 [1.900]	40.64 [1.600]	16.1 [.634]	4-173146-2
		40	55.9 [2.200]	48.26 [1.900]	16.1 [.634]	3-173146-8
		50	68.6 [2.700]	60.96 [2.400]	16.1 [.634]	3-173146-9
		60	81.3 [3.200]	73.66 [2.900]	16.1 [.634]	4-173146-0
	13.4 [.528]	26	38.1 [1.500]	30.48 [1.200]	16.1 [.634]	2-173146-8
		30	43.2 [1.700]	35.56 [1.400]	16.1 [.634]	2-173146-4
		34	48.3 [1.900]	40.64 [1.600]	16.1 [.634]	2-173146-9
		40	55.9 [2.200]	48.26 [1.900]	16.1 [.634]	2-173146-5
		50	68.6 [2.700]	60.96 [2.400]	16.1 [.634]	2-173146-6
		60	81.3 [3.200]	73.66 [2.900]	16.1 [.634]	2-173146-7

*Contact mating area: 0.00050 [.000020] min. gold over 0.00130 [.000050] min. nickel plated.

Note: All part numbers are RoHS compliant.

Application Tooling for ACTION PIN Stacking Connectors

Mini-Press



No. of Pos.	Part No.
40	1-758030-1
50	1-758030-2
60	1-758030-3

The part numbers above include the Mini-Press unit, insertion support plate and press-fit jig.

**Mini-Press Unit
Part No. 1-758030-3**

When ordering a press-fit jig only, consult the table below.

Press-fit Jig (separate order)

No. of Pos.	Part No.
26	907459-1
30	907459-2
34	907459-3
40	907459-4
50	907459-5
60	907459-6

Also, optional insertion support plates are obtainable by separate order to meet your specific requirements for improved board handling.

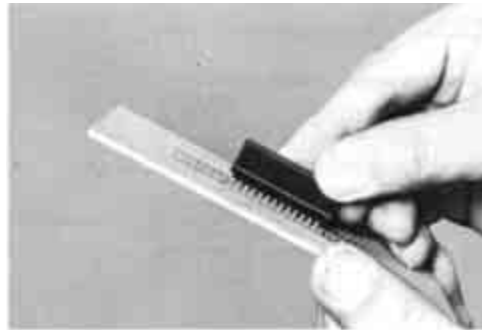

1. Insert connector into the board tentatively (Be sure that connector is in the right direction).

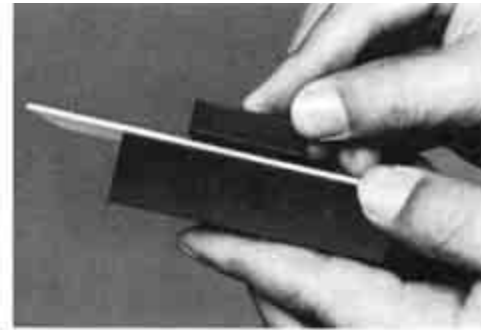

2. Attach insertion support plate to the leg portion of connector from below.



3. Set insertion support plate in place by butting it against Mini-Press platform.

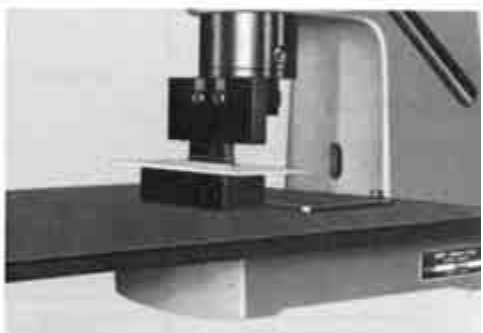

4. By pressing Mini-Press handle down, rest the press-fit jig against connector.

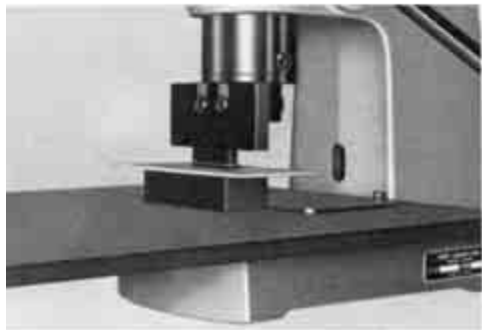

5. Press handle down gently and insert connector into the board.

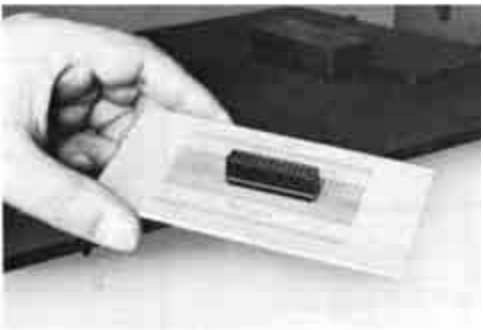

6. Now connector has been mounted to the board securely.



Insertion Support Unit (Option)



Note: All part numbers are RoHS compliant.

.025 [0.64] Square Posts

Bandolier Posts (Uninsulated)

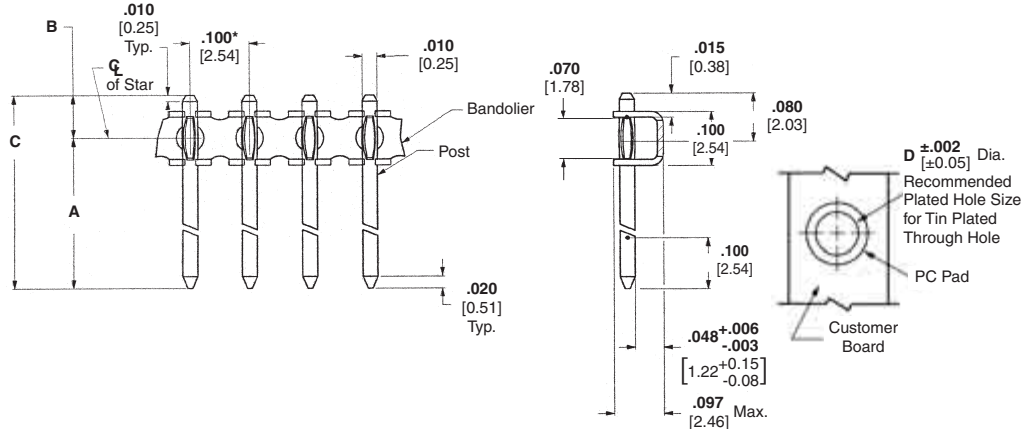

Material and Finish

- Bandolier** — Brass
- Posts** — Phosphor bronze, plated as follows:
 - Plating A** — Duplex plated .000030 [0.00076] gold on contact area, .000100-.000200 [0.00254-0.00508] tin on solder area, with entire post underplated. .000050 [0.00127] nickel
 - Plating B** — Duplex plated .000015 [0.00038] gold on contact area, .000100-.000200 [0.00254-0.00508] tin on solder area, with entire post underplated. .000050 [0.00127] nickel
 - Plating C** — .000100-.000200 [0.00254-0.00508] tin over .000050 [0.00127] nickel on entire post

Related Product Data

Mateable Connectors — Refer to the Mating Post Selection Guide — page 90

Accessories

- End Shrouds** — page 203
- Application Tooling** — page 153

Technical Documents — page 276

See mating connector for applicable product and application specifications.

Strip Form Posts (Uninsulated)

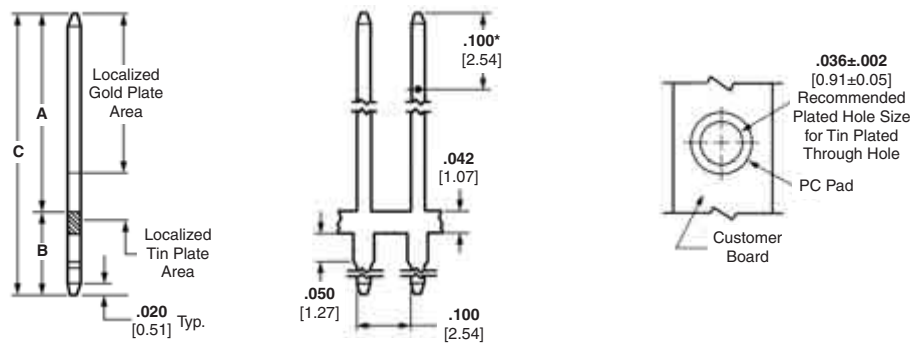

Material and Finish

- Posts** — Phosphor bronze, plated as follows:
 - Plating A** — Duplex plated .000030 [0.00076] gold on contact area, .000100-.000200 [0.00254-0.00508] tin on solder area, with entire post underplated. .000050 [0.00127] nickel
 - Plating B** — Duplex plated .000015 [0.00038] gold on contact area, .000100-.000200 [0.00254-0.00508] tin on solder area, with entire post underplated. .000050 [0.00127] nickel
 - Plating C** — .000030 [0.00076] gold over .000050 [0.00127] nickel on entire post
 - Plating D** — .000100-.000200 [0.00254-0.00508] tin over .000050 [0.00127] nickel on entire post

Dimensions				Post Plating/Part Nos.			Bandolier Insertion Head
A	B	C	D	Plating A	Plating B	Plating C	
.353 [8.97]	.071 [1.80]	.424 [10.77]	.034 [0.86]	5-103577-1	6-103577-3	5-103577-7	904592-1
.318 [8.08]	.071 [1.80]	.389 [9.88]	.034 [0.86]	5-103577-3	6-103577-5	5-103577-9	904591-1
.270 [6.86]	.071 [1.80]	.341 [8.66]	.034 [0.86]	5-103577-5	6-103577-7	6-103577-1	904590-1
.183 [4.65]	.097 [2.46]	.280 [7.11]	.031 [0.79]	5-146079-1	—	—	—
				—	—	6-146079-3	—

- Notes:**
1. Posts can be applied using **Hand Tool 91419-1**. *Point of measurement for plating thickness.
 2. Approximate posts per reel—30,000.
 3. The Bandolier Insertion Head can be used on the Comp-U-Sertor II machine or the Modular Insertion System Bench machine (see page 153).
 4. For PCB finishes other than tin, contact Tyco Electronics.

Dimensions			Post Plating/Part Nos.				Post/Tab Insertion Head
A	B	C	Plating A	Plating B	Plating C	Plating D	
.210 [5.33]	.227 [5.77]	.437 [11.10]	—	—	87878-6	1-87022-4	—
.278 [7.06]	.165 [4.19]	.443 [11.25]	5-87623-1	5-87623-4	87022-1	1-87022-0	904507-1
.278 [7.06]	.284 [7.21]	.562 [14.27]	—	—	1-87022-3	—	—
.278 [7.06]	.738 [18.75]	1.016 [25.81]	—	—	87022-2	87022-4	—
.318 [8.08]	.165 [4.19]	.483 [14.27]	—	—	4-87022-1	4-87022-3	—

- Notes:**
1. Approximate Posts per reel—20,000. *Point of measurement for plating thickness.
 2. Other post lengths are available, consult Tyco Electronics.
 3. The Post/Tab Insertion Head can be used on the Comp-U-Sertor II machine or the Modular Insertion System Bench machine (see page 153).
 4. For PCB finishes other than tin, contact Tyco Electronics.

Note: All part numbers are RoHS compliant.

AMPMODU .025 [0.64] Square Continuous Posts

Features of .025 [0.64] Square Continuous Posts

- Brass drawn wire for posts
- .400 to 1.000 [10.16 to 25.40] overall pin length (.010 [0.25] increments)
- Plating Options:
 - Tin
 - 15µ in. gold
 - 30µ in. gold
- Star feature also available

Benefits

- Less expensive than bandolier style posts
- Can be placed on printed circuit boards at any desired centerline
- Less scrap material (no carrier strip)

Technical Documents — page 276
Application Specification
114-13011



Tyco Electronics now offers AMPMODU .025 [0.64] Square Continuous Posts. These posts can be used instead of the original posts that come on a bandolier style carrier strip. These posts are on a reel, but the posts are 'notched' at the desired length (no carrier strip is needed). This feature allows more versatility by providing post lengths from .400 to 1.000 [10.16 to 25.40], available in increments of .010 [0.25].

The posts are brass drawn wire and are inserted into a printed circuit board via application tooling at any centerline configuration. They can be used for wire wrap applications or mated to a receptacle.

The current rating is 3 amps. The posts are available plated with tin, 15µ in. gold, or 30µ in. gold. Other platings are available upon request.

Tyco Electronics application tooling is a modular head (Part Number 904641-1) placed on the Modular Insertion System Bench Machine (Part Number 217600-1.)

Note: All part numbers are RoHS compliant.

AMPMODU .025 [0.64] Square Continuous Posts (Continued)

Pre-Plated Tin

Part Number		Description Post Length
Square	Square with Star	
147333-1	147433-1	0.400 [10.16]
147333-2	147433-2	0.410 [10.41]
147333-3	147433-3	0.420 [10.67]
147333-4	147433-4	0.430 [10.92]
147333-5	147433-5	0.440 [11.18]
147333-6	147433-6	0.450 [11.43]
147333-7	147433-7	0.460 [11.68]
147333-8	147433-8	0.470 [11.94]
147333-9	147433-9	0.480 [12.19]
1-147333-0	1-147433-0	0.490 [12.45]
1-147333-1	1-147433-1	0.500 [12.70]
1-147333-2	1-147433-2	0.510 [12.95]
1-147333-3	1-147433-3	0.520 [13.21]
1-147333-4	1-147433-4	0.530 [13.46]
1-147333-5	1-147433-5	0.540 [13.72]
1-147333-6	1-147433-6	0.550 [13.97]
1-147333-7	1-147433-7	0.560 [14.22]
1-147333-8	1-147433-8	0.570 [14.48]
1-147333-9	1-147433-9	0.580 [14.73]
2-147333-0	2-147433-0	0.590 [14.99]
2-147333-1	2-147433-1	0.600 [15.24]

Part Number		Description Post Length
Square	Square with Star	
2-147333-2	2-147433-2	0.610 [15.49]
2-147333-3	2-147433-3	0.620 [15.75]
2-147333-4	2-147433-4	0.630 [16.00]
2-147333-5	2-147433-5	0.640 [16.26]
2-147333-6	2-147433-6	0.650 [16.51]
2-147333-7	2-147433-7	0.660 [16.76]
2-147333-8	2-147433-8	0.670 [17.02]
2-147333-9	2-147433-9	0.680 [17.27]
3-147333-0	3-147433-0	0.690 [17.53]
3-147333-1	3-147433-1	0.700 [17.78]
3-147333-2	3-147433-2	0.710 [18.03]
3-147333-3	3-147433-3	0.720 [18.29]
3-147333-4	3-147433-4	0.730 [18.54]
3-147333-5	3-147433-5	0.740 [18.80]
3-147333-6	3-147433-6	0.750 [19.05]
3-147333-7	3-147433-7	0.760 [19.30]
3-147333-8	3-147433-8	0.770 [19.56]
3-147333-9	3-147433-9	0.780 [19.81]
4-147333-0	4-147433-0	0.790 [20.07]
4-147333-1	4-147433-1	0.800 [20.32]
4-147333-2	4-147433-2	0.810 [20.57]

Part Number		Description Post Length
Square	Square with Star	
4-147333-3	4-147433-3	0.820 [20.83]
4-147333-4	4-147433-4	0.830 [21.08]
4-147333-5	4-147433-5	0.840 [21.34]
4-147333-6	4-147433-6	0.850 [21.59]
4-147333-7	4-147433-7	0.860 [21.84]
4-147333-8	4-147433-8	0.870 [22.10]
4-147333-9	4-147433-9	0.880 [22.35]
5-147333-0	5-147433-0	0.890 [22.61]
5-147333-1	5-147433-1	0.900 [22.86]
5-147333-2	5-147433-2	0.910 [23.11]
5-147333-3	5-147433-3	0.920 [23.37]
5-147333-4	5-147433-4	0.930 [23.62]
5-147333-5	5-147433-5	0.940 [23.88]
5-147333-6	5-147433-6	0.950 [24.13]
5-147333-7	5-147433-7	0.960 [24.38]
5-147333-8	5-147433-8	0.970 [24.64]
5-147333-9	5-147433-9	0.980 [24.89]
6-147333-0	6-147433-0	0.990 [25.15]
6-147333-1	6-147433-1	1.000 [25.40]

Pre-Plated 15µ in. Gold

Part Number		Description Post Length
Square	Square with Star	
147334-1	147434-1	0.400 [10.16]
147334-2	147434-2	0.410 [10.41]
147334-3	147434-3	0.420 [10.67]
147334-4	147434-4	0.430 [10.92]
147334-5	147434-5	0.440 [11.18]
147334-6	147434-6	0.450 [11.43]
147334-7	147434-7	0.460 [11.68]
147334-8	147434-8	0.470 [11.94]
147334-9	147434-9	0.480 [12.19]
1-147334-0	1-147434-0	0.490 [12.45]
1-147334-1	1-147434-1	0.500 [12.70]
1-147334-2	1-147434-2	0.510 [12.95]
1-147334-3	1-147434-3	0.520 [13.21]
1-147334-4	1-147434-4	0.530 [13.46]
1-147334-5	1-147434-5	0.540 [13.72]
1-147334-6	1-147434-6	0.550 [13.97]
1-147334-7	1-147434-7	0.560 [14.22]
1-147334-8	1-147434-8	0.570 [14.48]
1-147334-9	1-147434-9	0.580 [14.73]
2-147334-0	2-147434-0	0.590 [14.99]
2-147334-1	2-147434-1	0.600 [15.24]

Part Number		Description Post Length
Square	Square with Star	
2-147334-2	2-147434-2	0.610 [15.49]
2-147334-3	2-147434-3	0.620 [15.75]
2-147334-4	2-147434-4	0.630 [16.00]
2-147334-5	2-147434-5	0.640 [16.26]
2-147334-6	2-147434-6	0.650 [16.51]
2-147334-7	2-147434-7	0.660 [16.76]
2-147334-8	2-147434-8	0.670 [17.02]
2-147334-9	2-147434-9	0.680 [17.27]
3-147334-0	3-147434-0	0.690 [17.53]
3-147334-1	3-147434-1	0.700 [17.78]
3-147334-2	3-147434-2	0.710 [18.03]
3-147334-3	3-147434-3	0.720 [18.29]
3-147334-4	3-147434-4	0.730 [18.54]
3-147334-5	3-147434-5	0.740 [18.80]
3-147334-6	3-147434-6	0.750 [19.05]
3-147334-7	3-147434-7	0.760 [19.30]
3-147334-8	3-147434-8	0.770 [19.56]
3-147334-9	3-147434-9	0.780 [19.81]
4-147334-0	4-147434-0	0.790 [20.07]
4-147334-1	4-147434-1	0.800 [20.32]
4-147334-2	4-147434-2	0.810 [20.57]

Part Number		Description Post Length
Square	Square with Star	
4-147334-3	4-147434-3	0.820 [20.83]
4-147334-4	4-147434-4	0.830 [21.08]
4-147334-5	4-147434-5	0.840 [21.34]
4-147334-6	4-147434-6	0.850 [21.59]
4-147334-7	4-147434-7	0.860 [21.84]
4-147334-8	4-147434-8	0.870 [22.10]
4-147334-9	4-147434-9	0.880 [22.35]
5-147334-0	5-147434-0	0.890 [22.61]
5-147334-1	5-147434-1	0.900 [22.86]
5-147334-2	5-147434-2	0.910 [23.11]
5-147334-3	5-147434-3	0.920 [23.37]
5-147334-4	5-147434-4	0.930 [23.62]
5-147334-5	5-147434-5	0.940 [23.88]
5-147334-6	5-147434-6	0.950 [24.13]
5-147334-7	5-147434-7	0.960 [24.38]
5-147334-8	5-147434-8	0.970 [24.64]
5-147334-9	5-147434-9	0.980 [24.89]
6-147334-0	6-147434-0	0.990 [25.15]
6-147334-1	6-147434-1	1.000 [25.40]

Pre-Plated 30µ in. Gold

Part Number		Description Post Length
Square	Square with Star	
147335-1	147435-1	0.400 [10.16]
147335-2	147435-2	0.410 [10.41]
147335-3	147435-3	0.420 [10.67]
147335-4	147435-4	0.430 [10.92]
147335-5	147435-5	0.440 [11.18]
147335-6	147435-6	0.450 [11.43]
147335-7	147435-7	0.460 [11.68]
147335-8	147435-8	0.470 [11.94]
147335-9	147435-9	0.480 [12.19]
1-147335-0	1-147435-0	0.490 [12.45]
1-147335-1	1-147435-1	0.500 [12.70]
1-147335-2	1-147435-2	0.510 [12.95]
1-147335-3	1-147435-3	0.520 [13.21]
1-147335-4	1-147435-4	0.530 [13.46]
1-147335-5	1-147435-5	0.540 [13.72]
1-147335-6	1-147435-6	0.550 [13.97]
1-147335-7	1-147435-7	0.560 [14.22]
1-147335-8	1-147435-8	0.570 [14.48]
1-147335-9	1-147435-9	0.580 [14.73]
2-147335-0	2-147435-0	0.590 [14.99]
2-147335-1	2-147435-1	0.600 [15.24]

Part Number		Description Post Length
Square	Square with Star	
2-147335-2	2-147435-2	0.610 [15.49]
2-147335-3	2-147435-3	0.620 [15.75]
2-147335-4	2-147435-4	0.630 [16.00]
2-147335-5	2-147435-5	0.640 [16.26]
2-147335-6	2-147435-6	0.650 [16.51]
2-147335-7	2-147435-7	0.660 [16.76]
2-147335-8	2-147435-8	0.670 [17.02]
2-147335-9	2-147435-9	0.680 [17.27]
3-147335-0	3-147435-0	0.690 [17.53]
3-147335-1	3-147435-1	0.700 [17.78]
3-147335-2	3-147435-2	0.710 [18.03]
3-147335-3	3-147435-3	0.720 [18.29]
3-147335-4	3-147435-4	0.730 [18.54]
3-147335-5	3-147435-5	0.740 [18.80]
3-147335-6	3-147435-6	0.750 [19.05]
3-147335-7	3-147435-7	0.760 [19.30]
3-147335-8	3-147435-8	0.770 [19.56]
3-147335-9	3-147435-9	0.780 [19.81]
4-147335-0	4-147435-0	0.790 [20.07]
4-147335-1	4-147435-1	0.800 [20.32]
4-147335-2	4-147435-2	0.810 [20.57]

Part Number		Description Post Length
Square	Square with Star	
4-147335-3	4-147435-3	0.820 [20.83]
4-147335-4	4-147435-4	0.830 [21.08]
4-147335-5	4-147435-5	0.840 [21.34]
4-147335-6	4-147435-6	0.850 [21.59]
4-147335-7	4-147435-7	0.860 [21.84]
4-147335-8	4-147435-8	0.870 [22.10]
4-147335-9	4-147435-9	0.880 [22.35]
5-147335-0	5-147435-0	0.890 [22.61]
5-147335-1	5-147435-1	0.900 [22.86]
5-147335-2	5-147435-2	0.910 [23.11]
5-147335-3	5-147435-3	0.920 [23.37]
5-147335-4	5-147435-4	0.930 [23.62]
5-147335-5	5-147435-5	0.940 [23.88]
5-147335-6	5-147435-6	0.950 [24.13]
5-147335-7	5-147435-7	0.960 [24.38]
5-147335-8	5-147435-8	0.970 [24.64]
5-147335-9	5-147435-9	0.980 [24.89]
6-147335-0	6-147435-0	0.990 [25.15]
6-147335-1	6-147435-1	1.000 [25.40]

Note: All part numbers are RoHS compliant.

AMPMODU .045 [1.14] Square Continuous Posts

Features of .045 [1.14] Square Continuous Posts

- Brass drawn wire for posts
- .400 to 1.000 [10.16 to 25.40] overall pin length (.010 [0.25] increments)
- Plating Options:
 - Tin
 - 15µ in. gold
 - 30µ in. gold
- Star feature also available

Benefits

- Less expensive than bandolier style posts
- Can be placed on printed circuit boards at any desired centerline
- Less scrap material (no carrier strip)

Technical Documents — page 276
Application Specification
 114-13011

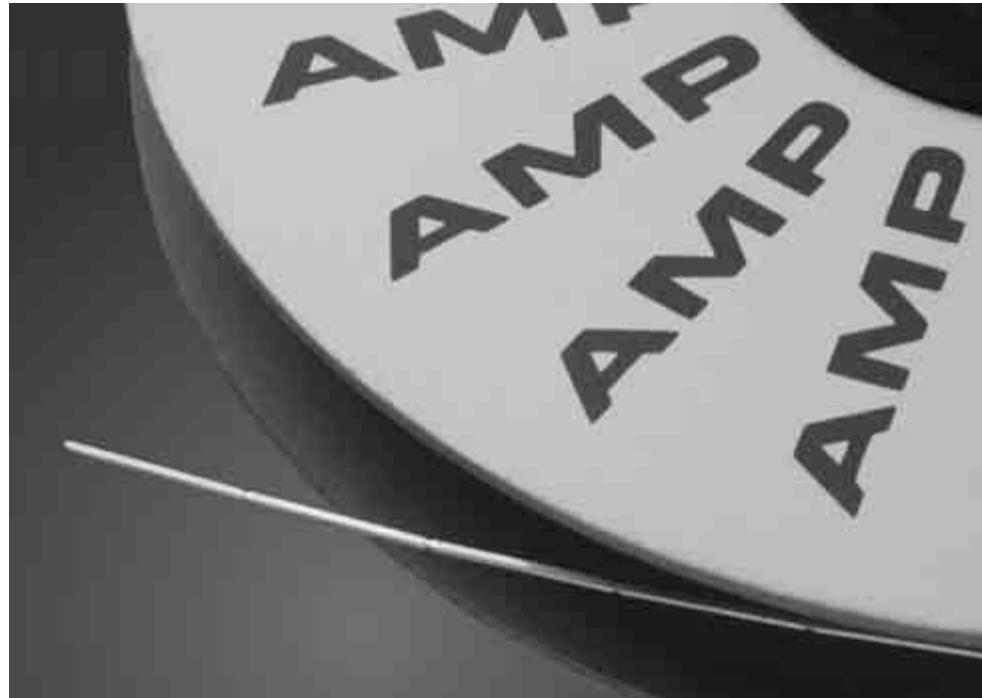

Tyco Electronics now offers AMPMODU .045 [1.14] Square Continuous Posts. These posts can be used instead of the original posts that come on a bandolier style carrier strip. These posts are on a reel, but the posts are 'notched' at the desired length (no carrier strip is needed). This feature allows more versatility by providing post lengths from .400 to 1.000 [10.16 to 25.40], available in increments of .010 [0.25].

The posts are brass drawn wire and are inserted into a printed circuit board via application tooling at any centerline configuration. They can be used for wire wrap applications or mated to a receptacle.

Potential industries include: building systems, commercial/home equipment, household appliances, home power tools and equipment.

The current rating is 7 amps. The posts are available plated with tin, 15µ in. gold, or 30µ in. gold. Other platings are available upon request.

Tyco Electronics application tooling is a modular head (Part Number 904640-1) placed on the Modular Insertion System Bench Machine (Part Number 217600-1.)

Note: All part numbers are RoHS compliant.

AMPMODU .045 [1.14] Square Continuous Posts (Continued)

Pre-Plated Tin

Part Number		Description Post Length
Square	Square with Star	
147070-1	147436-1	0.400 [10.16]
147070-2	147436-2	0.410 [10.41]
147070-3	147436-3	0.420 [10.67]
147070-4	147436-4	0.430 [10.92]
147070-5	147436-5	0.440 [11.18]
147070-6	147436-6	0.450 [11.43]
147070-7	147436-7	0.460 [11.68]
147070-8	147436-8	0.470 [11.94]
147070-9	147436-9	0.480 [12.19]
1-147070-0	1-147436-0	0.490 [12.45]
1-147070-1	1-147436-1	0.500 [12.70]
1-147070-2	1-147436-2	0.510 [12.95]
1-147070-3	1-147436-3	0.520 [13.21]
1-147070-4	1-147436-4	0.530 [13.46]
1-147070-5	1-147436-5	0.540 [13.72]
1-147070-6	1-147436-6	0.550 [13.97]
1-147070-7	1-147436-7	0.560 [14.22]
1-147070-8	1-147436-8	0.570 [14.48]
1-147070-9	1-147436-9	0.580 [14.73]
2-147070-0	2-147436-0	0.590 [14.99]
2-147070-1	2-147436-1	0.600 [15.24]

Part Number		Description Post Length
Square	Square with Star	
2-147070-2	2-147436-2	0.610 [15.49]
2-147070-3	2-147436-3	0.620 [15.75]
2-147070-4	2-147436-4	0.630 [16.00]
2-147070-5	2-147436-5	0.640 [16.26]
2-147070-6	2-147436-6	0.650 [16.51]
2-147070-7	2-147436-7	0.660 [16.76]
2-147070-8	2-147436-8	0.670 [17.02]
2-147070-9	2-147436-9	0.680 [17.27]
3-147070-0	3-147436-0	0.690 [17.53]
3-147070-1	3-147436-1	0.700 [17.78]
3-147070-2	3-147436-2	0.710 [18.03]
3-147070-3	3-147436-3	0.720 [18.29]
3-147070-4	3-147436-4	0.730 [18.54]
3-147070-5	3-147436-5	0.740 [18.80]
3-147070-6	3-147436-6	0.750 [19.05]
3-147070-7	3-147436-7	0.760 [19.30]
3-147070-8	3-147436-8	0.770 [19.56]
3-147070-9	3-147436-9	0.780 [19.81]
4-147070-0	4-147436-0	0.790 [20.07]
4-147070-1	4-147436-1	0.800 [20.32]
4-147070-2	4-147436-2	0.810 [20.57]

Part Number		Description Post Length
Square	Square with Star	
4-147070-3	4-147436-3	0.820 [20.83]
4-147070-4	4-147436-4	0.830 [21.08]
4-147070-5	4-147436-5	0.840 [21.34]
4-147070-6	4-147436-6	0.850 [21.59]
4-147070-7	4-147436-7	0.860 [21.84]
4-147070-8	4-147436-8	0.870 [22.10]
4-147070-9	4-147436-9	0.880 [22.35]
5-147070-0	5-147436-0	0.890 [22.61]
5-147070-1	5-147436-1	0.900 [22.86]
5-147070-2	5-147436-2	0.910 [23.11]
5-147070-3	5-147436-3	0.920 [23.37]
5-147070-4	5-147436-4	0.930 [23.62]
5-147070-5	5-147436-5	0.940 [23.88]
5-147070-6	5-147436-6	0.950 [24.13]
5-147070-7	5-147436-7	0.960 [24.38]
5-147070-8	5-147436-8	0.970 [24.64]
5-147070-9	5-147436-9	0.980 [24.89]
6-147070-0	6-147436-0	0.990 [25.15]
6-147070-1	6-147436-1	1.000 [25.40]

Pre-Plated 15µ in. Gold

Part Number		Description Post Length
Square	Square with Star	
147071-1	147437-1	0.400 [10.16]
147071-2	147437-2	0.410 [10.41]
147071-3	147437-3	0.420 [10.67]
147071-4	147437-4	0.430 [10.92]
147071-5	147437-5	0.440 [11.18]
147071-6	147437-6	0.450 [11.43]
147071-7	147437-7	0.460 [11.68]
147071-8	147437-8	0.470 [11.94]
147071-9	147437-9	0.480 [12.19]
1-147071-0	1-147437-0	0.490 [12.45]
1-147071-1	1-147437-1	0.500 [12.70]
1-147071-2	1-147437-2	0.510 [12.95]
1-147071-3	1-147437-3	0.520 [13.21]
1-147071-4	1-147437-4	0.530 [13.46]
1-147071-5	1-147437-5	0.540 [13.72]
1-147071-6	1-147437-6	0.550 [13.97]
1-147071-7	1-147437-7	0.560 [14.22]
1-147071-8	1-147437-8	0.570 [14.48]
1-147071-9	1-147437-9	0.580 [14.73]
2-147071-0	2-147437-0	0.590 [14.99]
2-147071-1	2-147437-1	0.600 [15.24]

Part Number		Description Post Length
Square	Square with Star	
2-147071-2	2-147437-2	0.610 [15.49]
2-147071-3	2-147437-3	0.620 [15.75]
2-147071-4	2-147437-4	0.630 [16.00]
2-147071-5	2-147437-5	0.640 [16.26]
2-147071-6	2-147437-6	0.650 [16.51]
2-147071-7	2-147437-7	0.660 [16.76]
2-147071-8	2-147437-8	0.670 [17.02]
2-147071-9	2-147437-9	0.680 [17.27]
3-147071-0	3-147437-0	0.690 [17.53]
3-147071-1	3-147437-1	0.700 [17.78]
3-147071-2	3-147437-2	0.710 [18.03]
3-147071-3	3-147437-3	0.720 [18.29]
3-147071-4	3-147437-4	0.730 [18.54]
3-147071-5	3-147437-5	0.740 [18.80]
3-147071-6	3-147437-6	0.750 [19.05]
3-147071-7	3-147437-7	0.760 [19.30]
3-147071-8	3-147437-8	0.770 [19.56]
3-147071-9	3-147437-9	0.780 [19.81]
4-147071-0	4-147437-0	0.790 [20.07]
4-147071-1	4-147437-1	0.800 [20.32]
4-147071-2	4-147437-2	0.810 [20.57]

Part Number		Description Post Length
Square	Square with Star	
4-147071-3	4-147437-3	0.820 [20.83]
4-147071-4	4-147437-4	0.830 [21.08]
4-147071-5	4-147437-5	0.840 [21.34]
4-147071-6	4-147437-6	0.850 [21.59]
4-147071-7	4-147437-7	0.860 [21.84]
4-147071-8	4-147437-8	0.870 [22.10]
4-147071-9	4-147437-9	0.880 [22.35]
5-147071-0	5-147437-0	0.890 [22.61]
5-147071-1	5-147437-1	0.900 [22.86]
5-147071-2	5-147437-2	0.910 [23.11]
5-147071-3	5-147437-3	0.920 [23.37]
5-147071-4	5-147437-4	0.930 [23.62]
5-147071-5	5-147437-5	0.940 [23.88]
5-147071-6	5-147437-6	0.950 [24.13]
5-147071-7	5-147437-7	0.960 [24.38]
5-147071-8	5-147437-8	0.970 [24.64]
5-147071-9	5-147437-9	0.980 [24.89]
6-147071-0	6-147437-0	0.990 [25.15]
6-147071-1	6-147437-1	1.000 [25.40]

Pre-Plated 30µ in. Gold

Part Number		Description Post Length
Square	Square with Star	
147072-1	147438-1	0.400 [10.16]
147072-2	147438-2	0.410 [10.41]
147072-3	147438-3	0.420 [10.67]
147072-4	147438-4	0.430 [10.92]
147072-5	147438-5	0.440 [11.18]
147072-6	147438-6	0.450 [11.43]
147072-7	147438-7	0.460 [11.68]
147072-8	147438-8	0.470 [11.94]
147072-9	147438-9	0.480 [12.19]
1-147072-0	1-147438-0	0.490 [12.45]
1-147072-1	1-147438-1	0.500 [12.70]
1-147072-2	1-147438-2	0.510 [12.95]
1-147072-3	1-147438-3	0.520 [13.21]
1-147072-4	1-147438-4	0.530 [13.46]
1-147072-5	1-147438-5	0.540 [13.72]
1-147072-6	1-147438-6	0.550 [13.97]
1-147072-7	1-147438-7	0.560 [14.22]
1-147072-8	1-147438-8	0.570 [14.48]
1-147072-9	1-147438-9	0.580 [14.73]
2-147072-0	2-147438-0	0.590 [14.99]
2-147072-1	2-147438-1	0.600 [15.24]

Part Number		Description Post Length
Square	Square with Star	
2-147072-2	2-147438-2	0.610 [15.49]
2-147072-3	2-147438-3	0.620 [15.75]
2-147072-4	2-147438-4	0.630 [16.00]
2-147072-5	2-147438-5	0.640 [16.26]
2-147072-6	2-147438-6	0.650 [16.51]
2-147072-7	2-147438-7	0.660 [16.76]
2-147072-8	2-147438-8	0.670 [17.02]
2-147072-9	2-147438-9	0.680 [17.27]
3-147072-0	3-147438-0	0.690 [17.53]
3-147072-1	3-147438-1	0.700 [17.78]
3-147072-2	3-147438-2	0.710 [18.03]
3-147072-3	3-147438-3	0.720 [18.29]
3-147072-4	3-147438-4	0.730 [18.54]
3-147072-5	3-147438-5	0.740 [18.80]
3-147072-6	3-147438-6	0.750 [19.05]
3-147072-7	3-147438-7	0.760 [19.30]
3-147072-8	3-147438-8	0.770 [19.56]
3-147072-9	3-147438-9	0.780 [19.81]
4-147072-0	4-147438-0	0.790 [20.07]
4-147072-1	4-147438-1	0.800 [20.32]
4-147072-2	4-147438-2	0.810 [20.57]

Part Number		Description Post Length
Square	Square with Star	
4-147072-3	4-147438-3	0.820 [20.83]
4-147072-4	4-147438-4	0.830 [21.08]
4-147072-5	4-147438-5	0.840 [21.34]
4-147072-6	4-147438-6	0.850 [21.59]
4-147072-7	4-147438-7	0.860 [21.84]
4-147072-8	4-147438-8	0.870 [22.10]
4-147072-9	4-147438-9	0.880 [22.35]
5-147072-0	5-147438-0	0.890 [22.61]
5-147072-1	5-147438-1	0.900 [22.86]
5-147072-2	5-147438-2	0.910 [23.11]
5-147072-3	5-147438-3	0.920 [23.37]
5-147072-4	5-147438-4	0.930 [23.62]
5-147072-5	5-147438-5	0.940 [23.88]
5-147072-6	5-147438-6	0.950 [24.13]
5-147072-7	5-147438-7	0.960 [24.38]
5-147072-8	5-147438-8	0.970 [24.64]
5-147072-9	5-147438-9	0.980 [24.89]
6-147072-0	6-147438-0	0.990 [25.15]
6-147072-1	6-147438-1	1.000 [25.40]

Note: All part numbers are RoHS compliant.

Receptacle Assemblies, Horizontal Mount

Product Facts

- All receptacle assemblies are end stackable
- Contact design employs dual cantilever beams with built-in anti-overstress feature
- Closed entry housings help prevent post stubbing
- Wide range of sizes available
- Other versions available upon request
- Housings made of high temperature, surface mount compatible thermoplastic material, 94V-0 rated
- Duplex gold and matte tin plated contacts have full nickel underplate
- Housings feature PC board standoffs
- Solder tails accommodate a PC board thickness of .062 [1.57]
- Recognized under the Component Program of Underwriters Laboratories Inc., File No. E28476
- Certified by Canadian Standards Association, File No. LR 7189

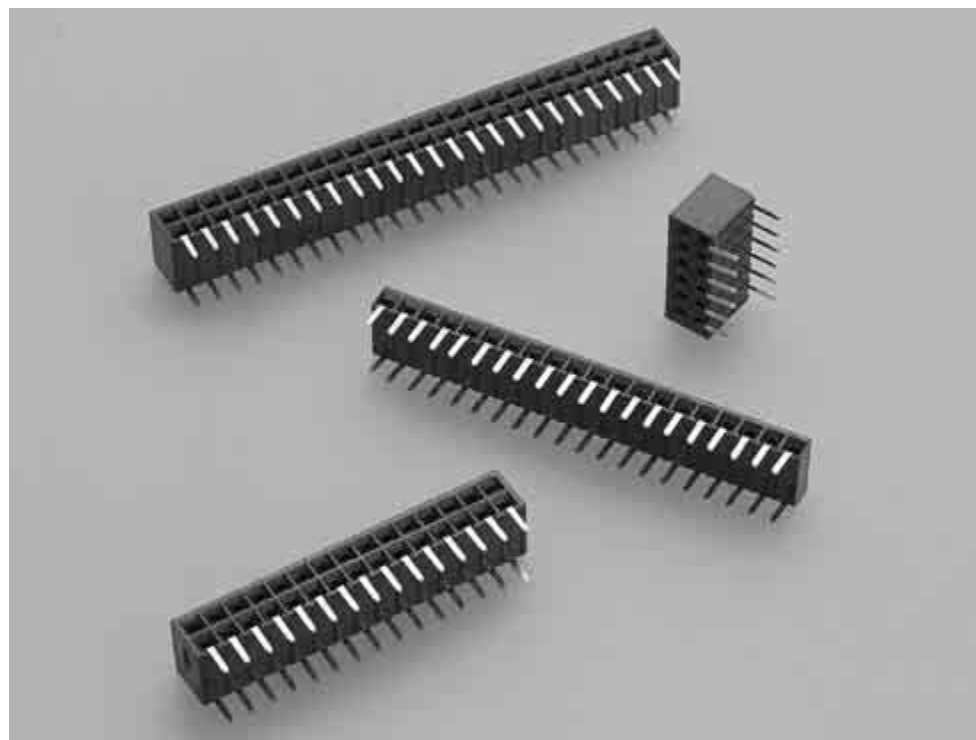

Horizontal Mount receptacle assemblies are designed to reliably and economically meet the packaging and interconnection requirements of today's electronics industry, generally for applications using the mother/daughter board arrangement.

This product line is offered in both single and double row configurations. The .100 [2.54] centerline

assemblies are available in a wide range of position sizes. They have end stacking capability which gives the added advantage of flexibility.

The housings are made of high temperature, surface mount compatible thermoplastic material that is 94V-0 rated. Contacts are phosphor bronze, fully underplated with nickel to help prevent corrosion and are available in three plating options.

The receptacle contact is an established proven design with a fully enclosed, one-piece "box" to protect the contact area. In addition, the receptacle contact has dual cantilever beams with a built-in anti-overstress feature. Standard solder tails accommodate a board thickness of .062 [1.57].

Performance Characteristics

Mechanical Characteristics

Mating Force — 6.0 oz. [1.67N] per contact (max.)

Unmating Force — .75 oz. [0.21N] per contact (min.) during third mating cycle

Durability — 200 cycles

Environmental Characteristics

Operating Temperature — -65°C to +125°C

Electrical Characteristics

Current Rating — 3.0 amperes (max.) for single contact; 2.0 amperes (max.) per contact when connector is fully energized

Contact Resistance — 12 milliohms (max.)

Insulation Resistance — 5000 megohms (min.) between adjacent contacts

Dielectric Withstanding Voltage (at sea level) — 750 V rms

Mod II Receptacle Assemblies, Single-Row, .100 [2.54] Centerline

Closed Entry, End Stackable, Short Point-of-Contact, with Standoffs



Material and Finish

Housing — Glass-filled thermoplastic, black, 94V-0 rated

Contacts — Phosphor bronze, plated as follows:

Plating A — Duplex .000030 [0.00076] gold on contact area, .000150-.000300 [0.00381-0.00762] matte tin on solder area all over .000050 [0.00127] nickel

Plating B — Duplex .000010 [0.000254] gold on contact area, .000150-.000300 [0.00381-0.00762] matte tin on solder area all over .000050 [0.00127] nickel

Plating C — .000150-.000300 [0.00381-0.00762] matte tin on solder leads, all over .000050 [0.00127] nickel

Related Product Data

Mateable Headers — Refer to the Mating Post Selection Guide — page 90

Performance Characteristics — page 168

Technical Documents — page 276

Product Specification 108-25026

Application Specification 114-25018

Additional receptacle assembly sizes are available; minimum order quantities may apply. Consult Tyco Electronics.

Keying Plug



Part No. 86286-1
(Plugs into receptacle contact)

Material — Natural color nylon

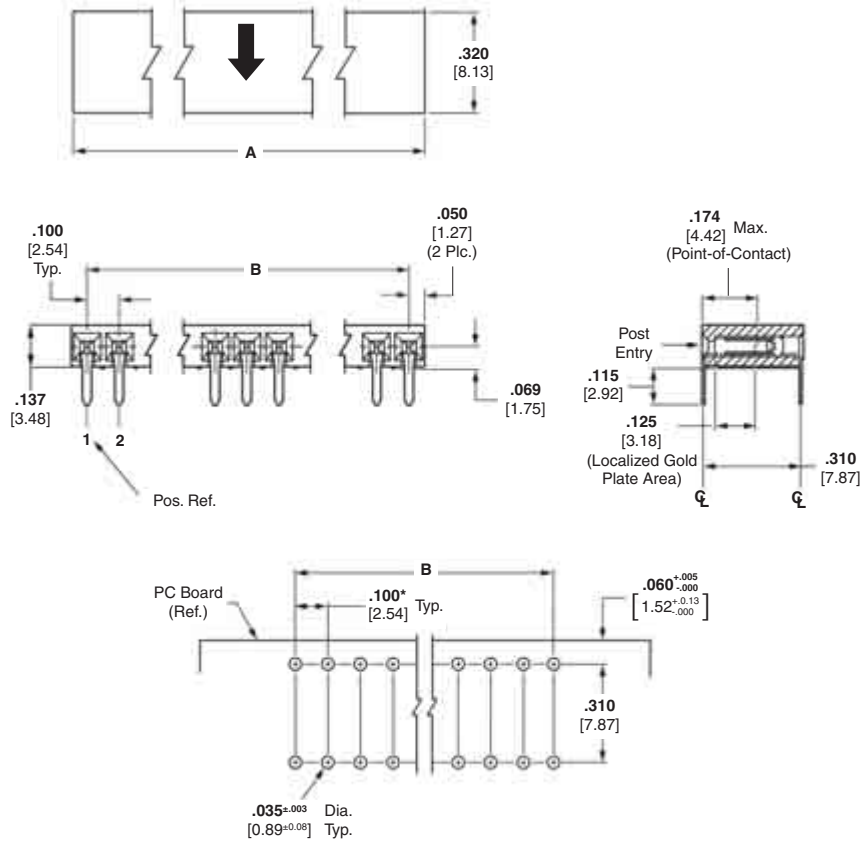

Recommended PC Board Hole Layout
(for .062 [1.57] thick PC board)

*±.003 [±0.08] tolerances not to accumulate within one connector pattern.

No. of Pos.	Dimensions		Contact Plating/Part Nos.		
	A	B	Plating A	Plating B	Plating C
2	.200 [5.08]	.100 [2.54]	5535676-1	5146139-1	5535677-1
3	.300 [7.62]	.200 [5.08]	5535676-2	5146139-2	5535677-2
4	.400 [10.16]	.300 [7.62]	5535676-3	5146139-3	5535677-3
5	.500 [12.70]	.400 [10.16]	5535676-4	5146139-4	5535677-4
6	.600 [15.24]	.500 [12.70]	5535676-5	5146139-5	5535677-5
7	.700 [17.78]	.600 [15.24]	5535676-6	5146139-6	5535677-6
8	.800 [20.32]	.700 [17.78]	5535676-7	5146139-7	5535677-7
9	.900 [22.86]	.800 [20.32]	5535676-8	5146139-8	5535677-8
10	1.000 [25.40]	.900 [22.86]	5535676-9	5146139-9	5535677-9
11	1.100 [27.94]	1.000 [25.40]	1-5535676-0	1-5146139-0	1-5535677-0
12	1.200 [30.48]	1.100 [27.94]	1-5535676-1	1-5146139-1	1-5535677-1
13	1.300 [33.02]	1.200 [30.48]	1-5535676-2	1-5146139-2	1-5535677-2
14	1.400 [35.56]	1.300 [33.02]	1-5535676-3	1-5146139-3	1-5535677-3
15	1.500 [38.10]	1.400 [35.56]	1-5535676-4	1-5146139-4	1-5535677-4
16	1.600 [40.64]	1.500 [38.10]	1-5535676-5	1-5146139-5	1-5535677-5
17	1.700 [43.18]	1.600 [40.64]	1-5535676-6	1-5146139-6	1-5535677-6
18	1.800 [45.72]	1.700 [43.18]	1-5535676-7	1-5146139-7	1-5535677-7
19	1.900 [48.26]	1.800 [45.72]	1-5535676-8	1-5146139-8	1-5535677-8
20	2.000 [50.80]	1.900 [48.26]	1-5535676-9	1-5146139-9	1-5535677-9
30	3.000 [76.20]	2.900 [73.66]	2-5535676-9	2-5146139-9	2-5535677-9
40	4.000 [101.60]	3.900 [99.06]	3-5535676-9	3-5146139-9	3-5535677-9

Note: 1. Tyco Electronics recommends mating gold or duplex plated headers with duplex plated receptacle assemblies.

Note: All part numbers are RoHS compliant.

Mod II Receptacle Assemblies, Double-Row, .100 x .100 [2.54 x 2.54] Centerlines

Closed Entry, End Stackable, Short Point-of-Contact, with Standoffs

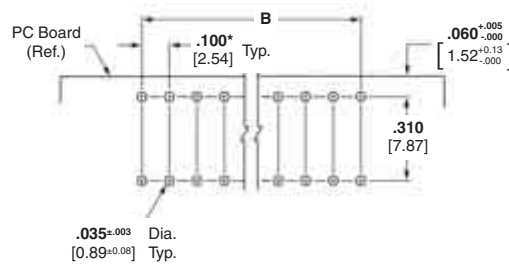
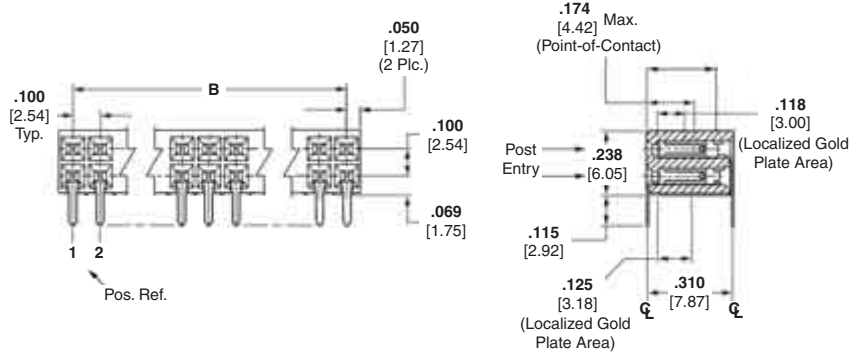
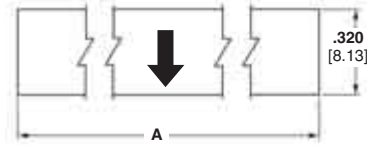
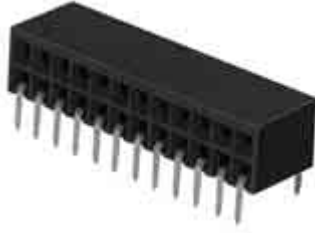

Recommended PC Board Hole Layout (for .062 [1.57] thick PC board)

*±.003 [±0.08] tolerances not to accumulate within one connector pattern.

Material and Finish

Housing — Glass-filled thermoplastic, black, 94V-0 rated

Contacts — Phosphor bronze, plated as follows:

Plating A — Duplex .000030 [0.00076] gold on contact area, .000150-.000300 [0.00381-0.00762] matte tin on solder area all over .000050 [0.00127] nickel

Plating B — Duplex .000010 [0.000254] gold on contact area, .000150-.000300 [0.00381-0.00762] matte tin on solder area all over .000050 [0.00127] nickel

Plating C — .000150-.000300 [0.00381-0.00762] matte tin on solder leads, all over .000050 [0.00127] nickel

Related Product Data

Mateable Headers — Refer to the Mating Post Selection Guide — page 90

Performance Characteristics — page 168

Technical Documents — page 276

Product Specification 108-25026

Application Specification 114-25018

Additional receptacle assembly sizes are available; minimum order quantities may apply. Consult Tyco Electronics.

No. of Pos.	Dimensions		Contact Plating/Part Nos.		
	A	B	Plating A	Plating B	Plating C
4	.200 [5.08]	.100 [2.54]	6-5535512-1	5146140-1	6-5102084-4
6	.300 [7.62]	.200 [5.08]	6-5535512-2	5146140-2	6-5102084-3
8	.400 [10.16]	.300 [7.62]	6-5535512-3	5146140-3	6-5102084-2
10	.500 [12.70]	.400 [10.16]	6-5535512-4	5146140-4	6-5102084-1
12	.600 [15.24]	.500 [12.70]	5535512-1	5146140-5	6-5102084-0
14	.700 [17.78]	.600 [15.24]	1-5535512-7	5146140-6	5-5102084-9
16	.800 [20.32]	.700 [17.78]	1-5535512-8	5146140-7	5-5102084-8
18	.900 [22.86]	.800 [20.32]	1-5535512-6	5146140-8	5-5102084-7
20	1.000 [25.40]	.900 [22.86]	5535512-2	5146140-9	5-5102084-6
22	1.100 [27.94]	1.000 [25.40]	1-5535512-9	1-5146140-0	5-5102084-5
24	1.200 [30.48]	1.100 [27.94]	5535512-3	1-5146140-1	5-5102084-4
26	1.300 [33.02]	1.200 [30.48]	2-5535512-0	1-5146140-2	5-5102084-3
28	1.400 [35.56]	1.300 [33.02]	2-5535512-1	1-5146140-3	5-5102084-2
30	1.500 [38.10]	1.400 [35.56]	2-5535512-2	1-5146140-4	5-5102084-1
32	1.600 [40.64]	1.500 [38.10]	2-5535512-3	1-5146140-5	5-5102084-0
34	1.700 [43.18]	1.600 [40.64]	5535512-4	1-5146140-6	4-5102084-9
36	1.800 [45.72]	1.700 [43.18]	5535512-5	1-5146140-7	4-5102084-8
38	1.900 [48.26]	1.800 [45.72]	2-5535512-4	1-5146140-8	4-5102084-7
40	2.000 [50.80]	1.900 [48.26]	2-5535512-5	1-5146140-9	4-5102084-6
50	2.500 [63.50]	2.400 [60.96]	5535512-7	2-5146140-0	4-5102084-1
60	3.000 [76.20]	2.900 [73.66]	3-5535512-0	2-5146140-1	3-5102084-6

Notes: 1. Tyco Electronics recommends mating gold or duplex plated headers with duplex plated receptacle assemblies.
2. .256 [6.50] minimum positive pin stop to prevent shorting between row.

Note: All part numbers are RoHS compliant.

**Mod II Surface Mount Horizontal Receptacle Assemblies,
.100 x .100 [2.54 x 2.54] Centerline**

Product Facts

- Surface mount leads
- All receptacle assemblies are end stackable
- Contact design employs dual cantilever beams with built-in anti-overstress feature
- Closed entry housings help prevent post stubbing
- Housings made of high temperature, surface mount compatible thermoplastic material, 94 V-0 rated
- Duplex gold and matte tin plated contacts have full nickel underplate
- Housings feature PC board standoffs
- Recognized under the Component Program of Underwriters Laboratories Inc., File No. E28476 

- Certified by Canadian Standards Association, File No. LR 7189 

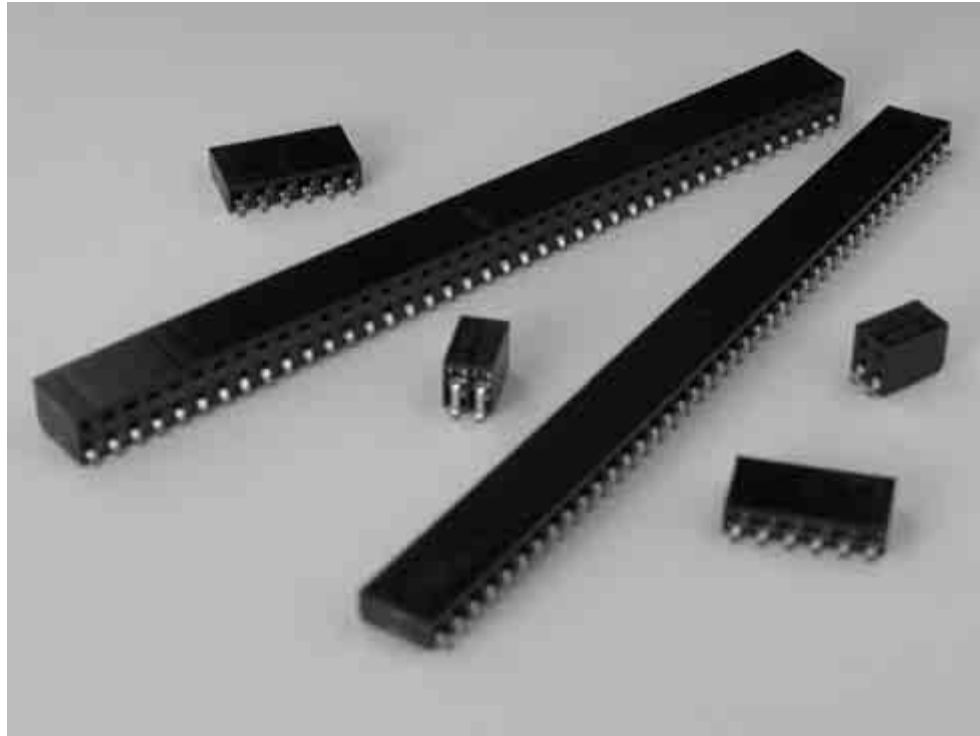

Horizontal surface mount receptacle assemblies are designed to reliably and economically meet the packaging and interconnection requirements of today's electronics industry as process technologies evolve from wave soldering to surface mount processing.

This broad product line is offered in both single and

double row configurations. The .100 [2.54] centerline assemblies are available in 2-40 (single row) positions and 4-80 (double row) positions. Housings are end stackable, which gives the advantage of added flexibility.

The housings are made of high temperature material that is 94V-0 rated. Contacts

are phosphor bronze, fully underplated with nickel to help prevent corrosion and are available in three plating options.

The receptacle contact is an established proven design, with a fully enclosed one-piece "box" to protect the contact beams with built-in anti-overstress feature.

Performance Characteristics

Mechanical Characteristics

Mating Force — 6.0 oz. [1.67N] per contact (max.)

Unmating Force — .75 oz. [0.21N] per contact (min.) during third mating cycle

Durability — 200 cycles

Environmental Characteristics

Operating Temperature — -65°C to +125°C

Electrical Characteristics

Current Rating — 3.0 amperes (max.) for single contact; 2.0 amperes (max.) per contact when connector is fully energized

Contact Resistance — 12 milliohms (max.)

Insulation Resistance — 5000 megohms (min.) between adjacent contacts

Dielectric Withstanding Voltage (at sea level) — 750 V rms

**Mod II Receptacle Assemblies, Single-Row, Surface Mount
.100 [2.54] Centerline**

**Closed Entry, End Stackable,
Short Point-of-Contact,
with Standoffs**

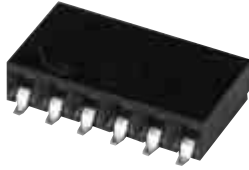

Material and Finish

Housing — Glass-filled thermoplastic, black, 94V-0 rated

Contacts — Phosphor bronze, plated as follows:

Plating A — Duplex .000030 [0.00076] gold on contact area, .000150-.000300 [0.00381-0.00762] matte tin on solder area all over .000050 [0.00127] nickel

Plating B — Duplex .000010 [0.000254] gold on contact area, .000150-.000300 [0.00381-0.00762] matte tin on solder area all over .000050 [0.00127] nickel

Plating C — .000150-.000300 [0.00381-0.00762] matte tin on solder leads, all over .000050 [0.00127] nickel

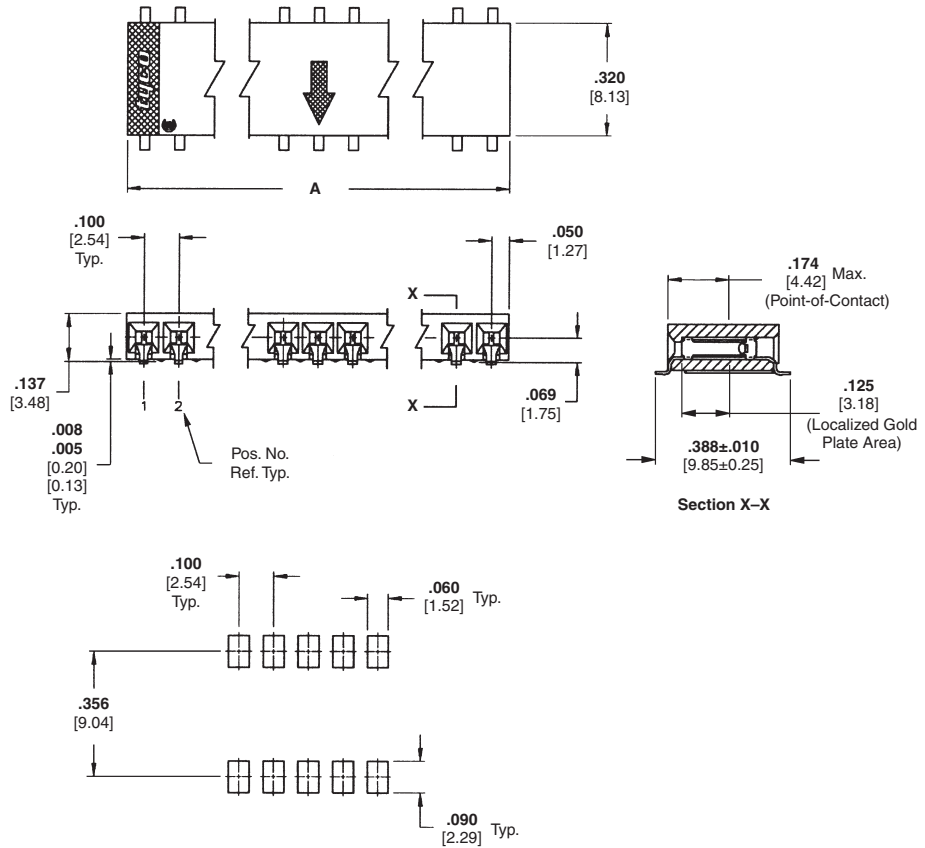

**Recommended Etched Circuit Layout
(for .040 [1.02] min. thick PC Board;
.008 [0.20] thick stencil)**

Related Product Data

Mateable Headers — Refer to the Mating Post Selection Guide — page 90

Performance Characteristics — page 171

Technical Documents — page 276

Product Specification
108-25026

Application Specification
114-25018

Additional receptacle assembly sizes are available; minimum order quantities may apply. Consult Tyco Electronics.

Keying Plug



Part No. 86286-1
(Plugs into receptacle contact)

Material — Natural color nylon

Note: All part numbers are RoHS compliant.

No. of Pos.	Dimension A	Contact Plating/Part Nos.		
		Plating A	Plating B	Plating C
2	.200 [5.08]	5147721-1	5147732-1	5147733-1
3	.300 [7.62]	5147721-2	5147732-2	5147733-2
4	.400 [10.16]	5147721-3	5147732-3	5147733-3
5	.500 [12.70]	5147721-4	5147732-4	5147733-4
6	.600 [15.24]	5147721-5	5147732-5	5147733-5
7	.700 [17.78]	5147721-6	5147732-6	5147733-6
8	.800 [20.32]	5147721-7	5147732-7	5147733-7
9	.900 [22.86]	5147721-8	5147732-8	5147733-8
10	1.000 [25.40]	5147721-9	5147732-9	5147733-9
11	1.100 [27.94]	1-5147721-0	1-5147732-0	1-5147733-0
12	1.200 [30.48]	1-5147721-1	1-5147732-1	1-5147733-1
13	1.300 [33.02]	1-5147721-2	1-5147732-2	1-5147733-2
14	1.400 [35.56]	1-5147721-3	1-5147732-3	1-5147733-3
15	1.500 [38.10]	1-5147721-4	1-5147732-4	1-5147733-4
16	1.600 [40.64]	1-5147721-5	1-5147732-5	1-5147733-5
17	1.700 [43.18]	1-5147721-6	1-5147732-6	1-5147733-6
18	1.800 [45.72]	1-5147721-7	1-5147732-7	1-5147733-7
19	1.900 [48.26]	1-5147721-8	1-5147732-8	1-5147733-8
20	2.000 [50.80]	1-5147721-9	1-5147732-9	1-5147733-9
30	3.000 [76.20]	2-5147721-9	2-5147732-9	2-5147733-9
40	4.000 [101.60]	3-5147721-9	3-5147732-9	3-5147733-9

**Mod II Receptacle Assemblies, Double-Row, Surface Mount
.100 [2.54] Centerline**

**Closed Entry, End Stackable,
Short Point-of-Contact,
with Standoffs**



Material and Finish

Housing — Glass-filled thermoplastic, black, 94V-0 rated

Contacts — Phosphor bronze, plated as follows:

Plating A — Duplex .000030 [0.00076] gold on contact area, .000150-.000300 [0.00381-0.00762] matte tin on solder area all over .000050 [0.00127] nickel

Plating B — Duplex .000010 [0.000254] gold on contact area, .000150-.000300 [0.00381-0.00762] matte tin on solder area all over .000050 [0.00127] nickel

Plating C — .000150-.000300 [0.00381-0.00762] matte tin on solder leads, all over .000050 [0.00127] nickel

Related Product Data

Mateable Headers — Refer to the Mating Post Selection Guide — page 90

Performance Characteristics — page 171

Technical Documents — page 276

Product Specification
108-25026

Application Specification
114-25018

Additional receptacle assembly sizes are available; minimum order quantities may apply. Consult Tyco Electronics.

Note: All part numbers are RoHS compliant.



Recommended Etched Circuit Layout
(for .040 [1.02] min thick PC Board;
.008 [0.20] thick stencil)

No. of Pos.	Dimension A	Contact Plating/Part Nos.		
		Plating A	Plating B	Plating C
4	.200 [5.08]	5147722-1	5147734-1	5147735-1
6	.300 [7.62]	5147722-2	5147734-2	5147735-2
8	.400 [10.16]	5147722-3	5147734-3	5147735-3
10	.500 [12.70]	5147722-4	5147734-4	5147735-4
12	.600 [15.24]	5147722-5	5147734-5	5147735-5
14	.700 [17.78]	5147722-6	5147734-6	5147735-6
16	.800 [20.32]	5147722-7	5147734-7	5147735-7
18	.900 [22.86]	5147722-8	5147734-8	5147735-8
20	1.000 [25.40]	5147722-9	5147734-9	5147735-9
22	1.100 [27.94]	1-5147722-0	1-5147734-0	1-5147735-0
24	1.200 [30.48]	1-5147722-1	1-5147734-1	1-5147735-1
26	1.300 [33.02]	1-5147722-2	1-5147734-2	1-5147735-2
28	1.400 [35.56]	1-5147722-3	1-5147734-3	1-5147735-3
30	1.500 [38.10]	1-5147722-4	1-5147734-4	1-5147735-4
32	1.600 [40.64]	1-5147722-5	1-5147734-5	1-5147735-5
34	1.700 [43.18]	1-5147722-6	1-5147734-6	1-5147735-6
36	1.800 [45.72]	1-5147722-7	1-5147734-7	1-5147735-7
38	1.900 [48.26]	1-5147722-8	1-5147734-8	1-5147735-8
40	2.000 [50.80]	1-5147722-9	1-5147734-9	1-5147735-9
50	2.500 [63.50]	2-5147722-4	2-5147734-4	2-5147735-4
60	3.000 [76.20]	2-5147722-9	2-5147734-9	2-5147735-9

Receptacle Assemblies, Vertical Mount

Product Facts

- Dual-cantilever beam contact with box design
- Single-row assemblies have .100 [2.54] centerline contact spacing; double-row assemblies have .100 x .100 [2.54 x 2.54] centerline contact spacing
- 3 through 40 positions in single-row assemblies; 2 through 80 positions in double-row assemblies
- Mod II Standard .340 [8.64] and Mod IV low .265 [6.73] profiles
- Mod II and Mod IV profiles available in dual entry
- Duplex gold and matte tin plated contacts have full nickel underplate
- Thermoplastic housings, 94V-0 rated
- Standoffs for easy flux cleaning
- All throughhole assemblies are end stackable
- Recognized under the Component Program of Underwriters Laboratories Inc., File No. E28476 
- Certified by Canadian Standards Association, File No. LR 7189 



Vertical receptacle assemblies are designed to reliably and economically meet the packaging and interconnection requirements of today's electronics industry.

This broad product line offers a wide variety of assembly styles and features. They are available in dual entry style, in both single and double row configurations. The .100 [2.54] centerline assemblies are available in 3-40 (single

row) positions and 2-80 (double row) positions. Standard and low profile housings which are end stackable also enhance the product line giving the advantage of added flexibility.

The housings are made of flame retardant material that is 94 V-0 rated. Contacts are phosphor bronze, fully underplated with nickel to help prevent corrosion and are available in three plating options.

The receptacle contact is an established proven design, with a fully enclosed one-piece "box" to protect the contact beams.

These assemblies are offered in .265 [6.73] (Mod IV) and .340[8.64] (Mod II) high profiles. Standard solder tails accommodate board thickness of .062 [1.57].

Product styles include single and dual tine variations. Outrigger tine styles are also available for bottom entry parallel board stacking applications.

Performance Characteristics

Mechanical Characteristics

Mating Force — 9.0 oz. [2.5N] per contact (max.)

Unmating Force — 1.5 oz. [0.42N] per contact (min.)

Durability (Tested to) — 200 cycles

Environmental Characteristics

Operating Temperature — -65°C to +125°C

Electrical Characteristics

Current Rating — 3.0 amperes (max.) for single contact; 2.0 amperes (max.) per contact when connector is fully energized

Contact Resistance — 12 milliohms (max.)

Insulation Resistance — 5000 megohms (min.) between adjacent contacts

Dielectric Withstanding Voltage (at sea level) — 750 V rms

Mod II Receptacle Assemblies, Single-Row, .100 [2.54] Centerline

Closed Top Entry, End Stackable, with Single Tine Contacts



Material and Finish

Housing — Glass-filled thermoplastic, black, 94V-0 rated

Contacts — Phosphor bronze, plated as follows:

Plating A — Duplex .000030 [0.00076] gold on contact area, .000150-.000300 [0.00381-0.00762] matte tin on solder area all over .000050 [0.00127] nickel

Plating B — Duplex .000010 [0.000254] gold on contact area, .000150-.000300 [0.00381-0.00762] matte tin on solder area all over .000050 [0.00127] nickel

Plating C — .000150-.000300 [0.00381-0.00762] matte tin on solder leads, all over .000050 [0.00127] nickel

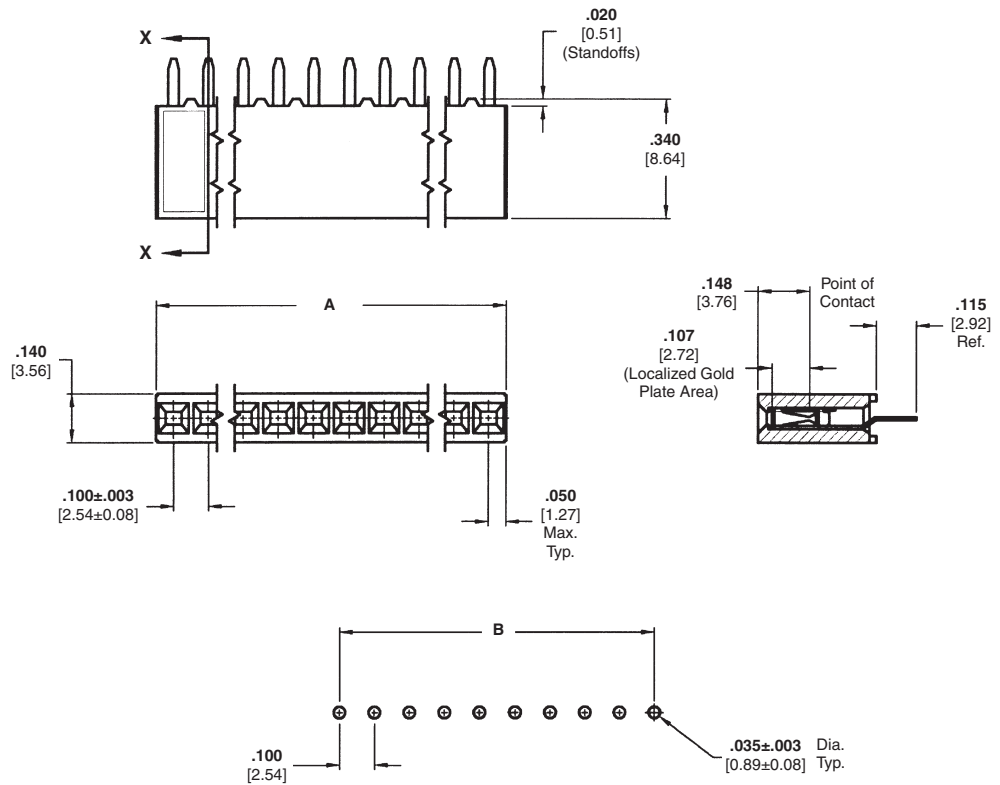

Recommended PC Board Hole Layout

Related Product Data

Mateable Headers — Refer to the Mating Post Selection Guide — page 90

Performance Characteristics — page 174

Technical Documents — page 276

Product Specification 108-25022

Application Specification 114-25018

Additional receptacle assembly sizes are available; minimum order quantities may apply. Consult Tyco Electronics.

Keying Plug



Part No. 86286-1

(Plugs into receptacle contact)

Material — Natural color nylon

No. of Pos.	Dimensions		Contact Plating/Part Nos.		
	A	B	Plating A	Plating B	Plating C
3	.300 [7.62]	.200 [5.08]	5-534237-1	5-146386-1	5-146763-1
4	.400 [10.16]	.300 [7.62]	5-534237-2	5-146386-9	5-146763-2
5	.500 [12.70]	.400 [10.16]	5-534237-3	5-146386-2	5-146763-3
6	.600 [15.24]	.500 [12.70]	5-534237-4	5-146386-3	5-146763-4
7	.700 [17.78]	.600 [15.24]	5-534237-5	5-146386-4	5-146763-5
8	.800 [20.32]	.700 [17.78]	5-534237-6	5-146386-5	5-146763-6
9	.900 [22.86]	.800 [20.32]	5-534237-7	5-146386-6	5-146763-7
10	1.000 [25.40]	.900 [22.86]	5-534237-8	5-146386-7	5-146763-8
11	1.100 [27.94]	1.000 [25.40]	5-534237-9	5-146386-8	5-146763-9
12	1.200 [30.48]	1.100 [27.94]	6-534237-0	5-146386-9	6-146763-0
13	1.300 [33.02]	1.200 [30.48]	6-534237-1	6-146386-0	6-146763-1
14	1.400 [35.56]	1.300 [33.02]	6-534237-2	6-146386-1	6-146763-2
15	1.500 [38.10]	1.400 [35.56]	6-534237-3	7-146386-0	6-146763-3
16	1.600 [40.64]	1.500 [38.10]	6-534237-4	7-146386-1	6-146763-4
17	1.700 [43.18]	1.600 [40.64]	6-534237-5	7-146386-2	6-146763-5
18	1.800 [45.72]	1.700 [43.18]	6-534237-6	7-146386-3	6-146763-6
19	1.900 [48.26]	1.800 [45.72]	6-534237-7	7-146386-4	6-146763-7
20	2.000 [50.80]	1.900 [48.26]	6-534237-8	6-146386-2	6-146763-8
30	3.000 [76.20]	2.900 [73.66]	7-534237-9	6-146386-8	7-146763-9
40	4.000 [101.60]	3.900 [99.06]	8-534237-9	8-146386-8	8-146763-9

- Notes:** 1. Tyco Electronics recommends mating gold or duplex plated headers with duplex plated receptacle assemblies.
2. To obtain the minimum mating post length, add .020 [0.51] (not including the post lead in chamfer) to the maximum point-of-contact dimension.

Note: All part numbers are RoHS compliant.

Mod II Receptacle Assemblies, Double-Row, .100 x .100 [2.54 x 2.54] Centerline

Closed Top Entry, Side and End Stackable .100 x .100 [2.54 x 2.54] Centerline, .100 [2.54] Tine Spacing



Material and Finish

Housing — Glass-filled thermoplastic, black, 94V-0 rated

Contacts — Phosphor bronze, plated as follows:

Plating A — Duplex .000030 [0.00076] gold on contact area, .000150-.000300 [0.00381-0.00762] matte tin on solder area all over .000050 [0.00127] nickel

Plating B — Duplex .000010 [0.000254] gold on contact area, .000150-.000300 [0.00381-0.00762] matte tin on solder area all over .000050 [0.00127] nickel

Plating C — .000150-.000300 [0.00381-0.00762] matte tin on solder leads, all over .000050 [0.00127] nickel

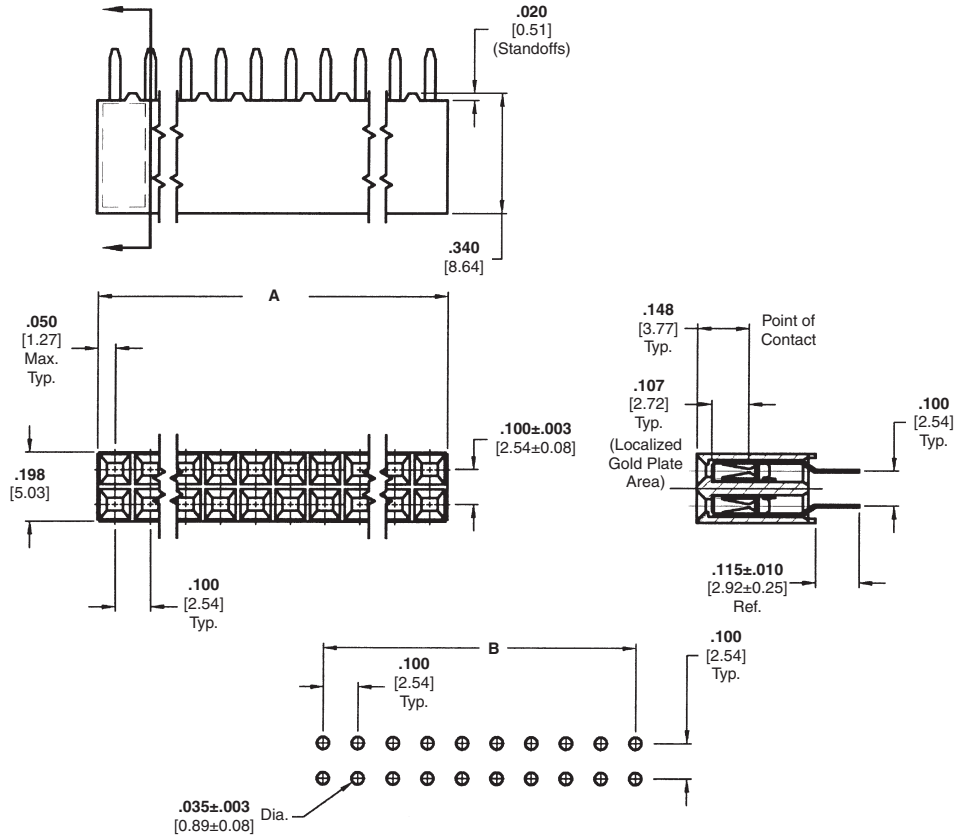

Recommended PC Board Hole Layout (for .062 [1.57] thick PC board)

Related Product Data

Mateable Headers — Refer to the Mating Post Selection Guide — page 90

Performance Characteristics — page 174

Technical Documents — page 276

Product Specification 108-25022

Application Specification 114-25018

Additional receptacle assembly sizes are available; minimum order quantities may apply. Consult Tyco Electronics.

Keying Plug



Part No. 86286-1
(Plugs into receptacle contact)

Material — Natural color nylon

No. of Pos.	Dimensions		Contact Plating/Part Nos.		
	A	B	Plating A	Plating B	Plating C
2	.100 [2.54]	—	5-534206-1	5-147424-1	5-146762-8
4	.200 [5.08]	.100 [2.54]	5-534206-2	5-147424-2	5-146762-9
6	.300 [7.62]	.200 [5.08]	5-534206-3	5-147424-3	6-146762-0
8	.400 [10.16]	.300 [7.62]	5-534206-4	5-147424-4	5-146762-1
10	.500 [12.70]	.400 [10.16]	5-534206-5	5-147424-5	5-146762-2
12	.600 [15.24]	.500 [12.70]	5-534206-6	5-147424-6	6-146762-1
14	.700 [17.78]	.600 [15.24]	5-534206-7	5-147424-7	6-146762-2
16	.800 [20.32]	.700 [17.78]	5-534206-8	5-147424-8	6-146762-3
18	.900 [22.86]	.800 [20.32]	5-534206-9	5-147424-9	5-146762-3
20	1.000 [25.40]	.900 [22.86]	6-534206-0	6-147424-0	5-146762-7
22	1.100 [27.94]	1.000 [25.40]	6-534206-1	6-147424-1	6-146762-4
24	1.200 [30.48]	1.100 [27.94]	6-534206-2	6-147424-2	6-146762-5
26	1.300 [33.02]	1.200 [30.48]	6-534206-3	6-147424-3	6-146762-6
28	1.400 [35.56]	1.300 [33.02]	6-534206-4	6-147424-4	6-146762-7
30	1.500 [38.10]	1.400 [35.56]	6-534206-5	6-147424-5	5-146762-4
32	1.600 [40.64]	1.500 [38.10]	6-534206-6	6-147424-6	6-146762-8
34	1.700 [43.18]	1.600 [40.64]	6-534206-7	6-147424-7	6-146762-9
36	1.800 [45.72]	1.700 [43.18]	6-534206-8	6-147424-8	7-146762-0
38	1.900 [48.26]	1.800 [45.72]	6-534206-9	6-147424-9	7-146762-1
40	2.000 [50.80]	1.900 [48.26]	7-534206-0	7-147424-0	5-146762-5

- Notes:** 1. Tyco Electronics recommends mating gold or duplex plated headers with duplex plated receptacle assemblies.
2. To obtain the minimum mating post length, add .020 [0.51] (not including the post lead in chamfer) to the maximum point-of-contact dimension.

Note: All part numbers are RoHS compliant.

Mod IV Receptacle Assemblies, Single-Row, .100 [2.54] Centerline

Bottom Entry, End Stackable, Low Profile with Dual Tine Contacts

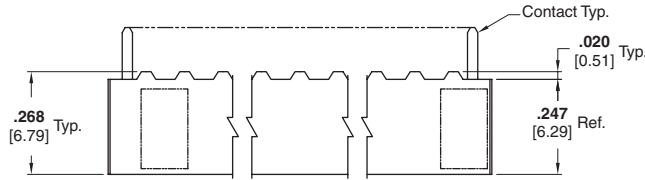

Material and Finish

Housing — Glass-filled thermoplastic, black, 94V-0 rated

Contacts — Phosphor bronze, plated as follows:

Plating A — Duplex .000030 [0.00076] gold on contact area, .000150-.000300 [0.00381-0.00762] matte tin on solder area all over .000050 [0.00127] nickel

Plating B — Duplex .000010 [0.000254] gold on contact area, .000150-.000300 [0.00381-0.00762] matte tin on solder area all over .000050 [0.00127] nickel

Plating C — .000150-.000300 [0.00381-0.00762] matte tin on solder leads, all over .000050 [0.00127] nickel

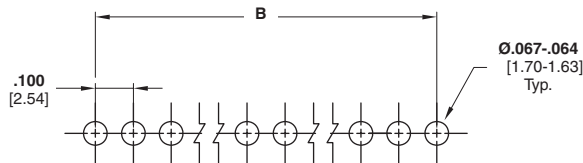
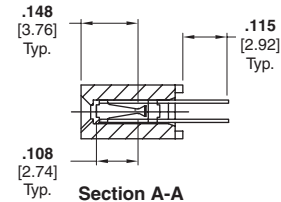
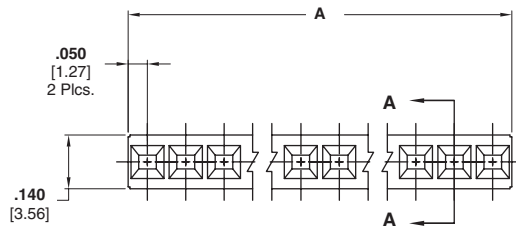

Recommended PC Board Hole Layout

Related Product Data

Mateable Headers — Refer to the Mating Post Selection Guide — page 90

Performance Characteristics — page 174

Technical Documents — page 276

Product Specification 108-25022

Application Specification 114-25018

Additional receptacle assembly sizes are available; minimum order quantities may apply. Consult Tyco Electronics.

Keying Plug



Part No. 86286-1
(Plugs into receptacle contact)

Material — Natural color nylon

Note: All part numbers are RoHS compliant.

No. of Pos.	Dimensions		Contact Plating/Part Nos.		
	A	B	Plating A	Plating B	Plating C
3	.300 [7.62]	.200 [5.08]	8-87879-7	5-147326-1	5-102742-4
4	.400 [10.16]	.300 [7.62]	8-87879-6	5-147326-2	5-102742-8
5	.500 [12.70]	.400 [10.16]	8-87879-8	5-147326-3	5-102742-9
6	.600 [15.24]	.500 [12.70]	5-87879-3	5-147326-4	6-102742-0
7	.700 [17.78]	.600 [15.24]	5-87879-4	5-147326-5	5-102742-7
8	.800 [20.32]	.700 [17.78]	5-87879-1	5-147326-6	5-102742-3
9	.900 [22.86]	.800 [20.32]	5-87879-5	5-147326-7	5-102742-6
10	1.000 [25.40]	.900 [22.86]	5-87879-2	5-147326-8	6-102742-1
11	1.100 [27.94]	1.000 [25.40]	5-87879-6	5-147326-9	5-102742-1
12	1.200 [30.48]	1.100 [27.94]	5-87879-7	6-147326-0	5-102742-2
13	1.300 [33.02]	1.200 [30.48]	5-87879-8	6-147326-1	6-102742-2
14	1.400 [35.56]	1.300 [33.02]	5-87879-9	6-147326-2	6-102742-3
15	1.500 [38.10]	1.400 [35.56]	6-87879-0	6-147326-3	6-102742-4
16	1.600 [40.64]	1.500 [38.10]	6-87879-1	6-147326-4	5-102742-5
17	1.700 [43.18]	1.600 [40.64]	6-87879-2	6-147326-5	6-102742-5
18	1.800 [45.72]	1.700 [43.18]	6-87879-3	6-147326-6	6-102742-6
19	1.900 [48.26]	1.800 [45.72]	6-87879-4	6-147326-7	6-102742-7
20	2.000 [50.80]	1.900 [48.26]	6-87879-5	6-147326-8	6-102742-8
30	3.000 [76.20]	2.900 [73.66]	7-87879-5	7-147326-8	7-102742-8
40	4.000 [101.60]	3.900 [99.06]	8-87879-5	8-147326-8	8-102742-8

- Notes:** 1. Tyco Electronics recommends mating gold or duplex plated headers with duplex plated receptacle assemblies.
2. To obtain the minimum mating post length, add .020 [0.51] (not including the post lead in chamfer) to the maximum point-of-contact dimension and .062 for recommended board thickness.

Mod IV Receptacle Assemblies, Single-Row, .100 [2.54] Centerline

Closed Top Entry, End Stackable, Low Profile with Single Tine Contacts

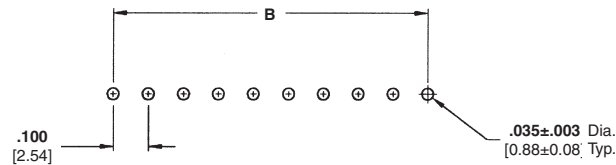
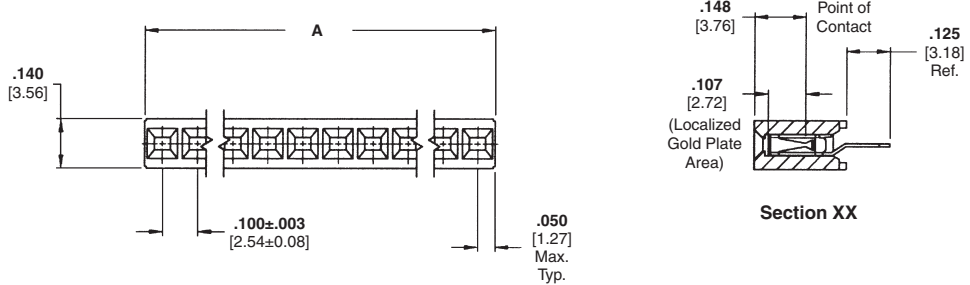
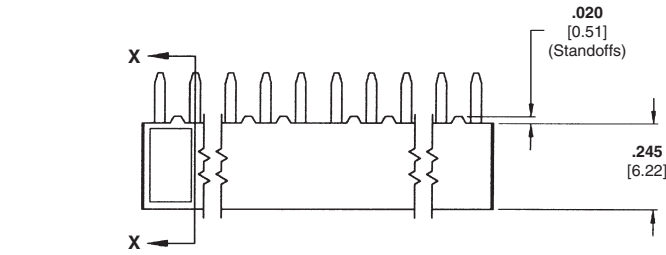

Recommended PC Board Hole Layout (for .062 [1.57] thick PC board)

Material and Finish

Housing — Glass-filled thermoplastic, black, 94V-0 rated

Contacts — Phosphor bronze, plated as follows:

Plating A — Duplex .000030 [0.00076] gold on contact area, .000150-.000300 [0.00381-0.00762] matte tin on solder area all over .000050 [0.00127] nickel

Plating B — Duplex .000010 [0.000254] gold on contact area, .000150-.000300 [0.00381-0.00762] matte tin on solder area all over .000050 [0.00127] nickel

Plating C — .000150-.000300 [0.00381-0.00762] matte tin on solder leads, all over .000050 [0.00127] nickel

Related Product Data

Mateable Headers — Refer to the Mating Post Selection Guide — page 90

Performance Characteristics — page 174

Technical Documents — page 276

Product Specification 108-25022

Application Specification 114-25018

Additional receptacle assembly sizes are available; minimum order quantities may apply. Consult Tyco Electronics.

No. of Pos.	Dimensions		Contact Plating/Part Nos.		
	A	B	Plating A	Plating B	Plating C
3	.300 [7.62]	.200 [5.08]	5-535541-1	5-146138-1	5-535584-3
4	.400 [10.16]	.300 [7.62]	5-535541-2	5-146138-2	5-535584-4
5	.500 [12.70]	.400 [10.16]	5-535541-3	5-146138-3	5-535584-5
6	.600 [15.24]	.500 [12.70]	5-535541-4	5-146138-4	5-535584-1
7	.700 [17.78]	.600 [15.24]	5-535541-5	5-146138-5	5-535584-6
8	.800 [20.32]	.700 [17.78]	5-535541-6	5-146138-6	5-535584-7
9	.900 [22.86]	.800 [20.32]	5-535541-7	5-146138-7	5-535584-8
10	1.000 [25.40]	.900 [22.86]	5-535541-8	5-146138-8	5-535584-9
11	1.100 [27.94]	1.000 [25.40]	5-535541-9	5-146138-9	6-535584-0
12	1.200 [30.48]	1.100 [27.94]	6-535541-0	6-146138-0	6-535584-1
13	1.300 [33.02]	1.200 [30.48]	6-535541-1	6-146138-1	6-535584-2
14	1.400 [35.56]	1.300 [33.02]	6-535541-2	6-146138-2	6-535584-3
15	1.500 [38.10]	1.400 [35.56]	6-535541-3	6-146138-3	6-535584-4
16	1.600 [40.64]	1.500 [38.10]	6-535541-4	6-146138-4	6-535584-5
17	1.700 [43.18]	1.600 [40.64]	6-535541-5	6-146138-5	6-535584-6
18	1.800 [45.72]	1.700 [43.18]	6-535541-6	6-146138-6	5-535584-2
19	1.900 [48.26]	1.800 [45.72]	6-535541-7	6-146138-7	6-535584-7
20	2.000 [50.80]	1.900 [48.26]	6-535541-8	6-146138-8	6-535584-8
30	3.000 [76.20]	2.900 [73.66]	7-535541-9	7-146138-9	6-535584-9
40	4.000 [101.60]	3.900 [99.06]	8-535541-9	8-146138-9	7-535584-0

Notes: 1. Tyco Electronics recommends mating gold or duplex plated headers with select gold plated receptacle assemblies.
2. To obtain the minimum mating post length, add .020 [0.51] (not including the post lead in chamfer) to the maximum point-of-contact dimension.

Note: All part numbers are RoHS compliant.

Vertical Mount Receptacle Assemblies

5

Mod IV Receptacle Assemblies, Double-Row, .100 x .100 [2.54 x 2.54] Centerline

Closed Top Entry, End and Side Stackable, Low Profile, .100 x .100 [2.54 x 2.54] Centerline, .100 [2.54] Tine Spacing



Material and Finish

Housing — Glass-filled thermoplastic, black, 94V-0 rated

Contacts — Phosphor bronze, plated as follows:

Plating A — Duplex .000030 [0.00076] gold on contact area, .000150-.000300 [0.00381-0.00762] matte tin on solder area all over .000050 [0.00127] nickel

Plating B — Duplex .000010 [0.000254] gold on contact area, .000150-.000300 [0.00381-0.00762] matte tin on solder area all over .000050 [0.00127] nickel

Plating C — .000150-.000300 [0.00381-0.00762] matte tin on solder leads, all over .000050 [0.00127] nickel

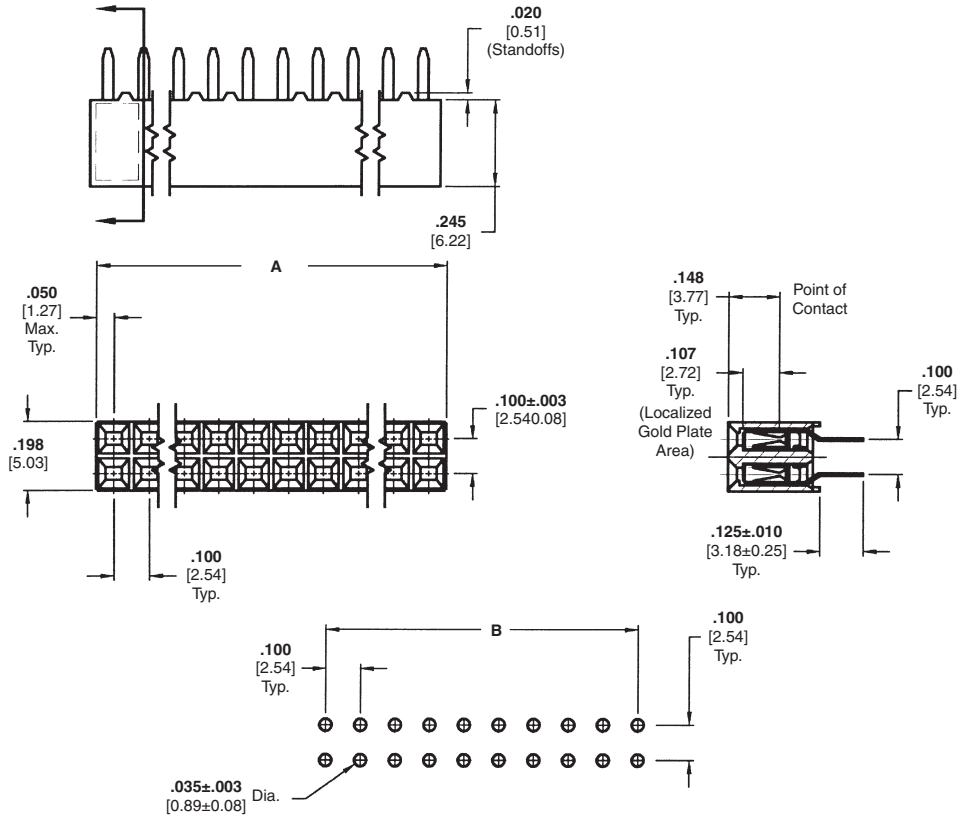

Recommended PC Board Hole Layout

Related Product Data

Mateable Headers —

Refer to the Mating Post Selection Guide — page 90

Performance Characteristics — page 174

Technical Documents — page 276

Product Specification

108-25022

Application Specification

114-25018

No. of Pos.	Dimensions		Contact Plating/Part Nos.		
	A	B	Plating A	Plating B	Plating C
2	.100 [2.54]	—	5-534998-1	5-535598-2	5-535585-3
4	.200 [5.08]	.100 [2.54]	5-534998-2	5-535598-3	5-535585-4
6	.300 [7.62]	.200 [5.08]	5-534998-3	5-535598-4	5-535585-5
8	.400 [10.16]	.300 [7.62]	5-534998-4	5-535598-5	5-535585-6
10	.500 [12.70]	.400 [10.16]	5-534998-5	5-535598-6	5-535585-1
12	.600 [15.24]	.500 [12.70]	5-534998-6	5-535598-7	5-535585-2
14	.700 [17.78]	.600 [15.24]	5-534998-7	5-535598-1	5-535585-7
16	.800 [20.32]	.700 [17.78]	5-534998-8	5-535598-8	5-535585-8
18	.900 [22.86]	.800 [20.32]	5-534998-9	5-535598-9	5-535585-9
20	1.000 [25.40]	.900 [22.86]	6-534998-0	6-535598-0	6-535585-0
22	1.100 [27.94]	1.000 [25.40]	6-534998-1	6-535598-1	6-535585-1
24	1.200 [30.48]	1.100 [27.94]	6-534998-2	6-535598-2	6-535585-2
26	1.300 [33.02]	1.200 [30.48]	6-534998-3	6-535598-3	6-535585-3
28	1.400 [35.56]	1.300 [33.02]	6-534998-4	6-535598-4	6-535585-4
30	1.500 [38.10]	1.400 [35.56]	6-534998-5	6-535598-5	6-535585-5
32	1.600 [40.64]	1.500 [38.10]	6-534998-6	6-535598-6	6-535585-6
34	1.700 [43.18]	1.600 [40.64]	6-534998-7	6-535598-7	6-535585-7
36	1.800 [45.72]	1.700 [43.18]	6-534998-8	6-535598-8	6-535585-8
38	1.900 [48.26]	1.800 [45.72]	6-534998-9	6-535598-9	6-535585-9
40	2.000 [50.80]	1.900 [48.26]	7-534998-0	7-535598-0	7-535585-0

- Notes:** 1. Tyco Electronics recommends mating gold or duplex plated headers with duplex plated receptacle assemblies.
 2. To obtain the minimum mating post length, add .020 [0.51] (not including the post lead in chamfer) to the maximum point-of-contact dimension.

Note: All part numbers are RoHS compliant.

Mod IV Receptacle Assemblies, Double-Row, .100 x .100 [2.54 x 2.54] Centerline (Continued)

Keying Plug



Part No. 86286-1

(Plugs into receptacle contact)

Material — Natural color nylon

No. of Pos.	Dimensions		Contact Plating/Part Nos.		
	A	B	Plating A	Plating B	Plating C
42	2.100 [53.34]	2.000 [50.80]	7-534998-1	7-535598-4	7-535585-4
44	2.200 [55.88]	2.100 [53.34]	7-534998-2	7-535598-5	7-535585-5
46	2.300 [58.42]	2.200 [55.88]	7-534998-3	7-535598-6	7-535585-6
48	2.400 [60.96]	2.300 [58.42]	7-534998-4	7-535598-7	7-535585-7
50	2.500 [63.50]	2.400 [60.96]	7-534998-5	7-535598-1	7-535585-1
52	2.600 [66.04]	2.500 [63.50]	7-534998-6	7-535598-8	7-535585-8
54	2.700 [68.58]	2.600 [66.04]	7-534998-7	7-535598-9	7-535585-9
56	2.800 [71.12]	2.700 [68.58]	7-534998-8	8-535598-0	8-535585-0
58	2.900 [73.66]	2.800 [71.12]	7-534998-9	8-535598-1	8-535585-1
60	3.000 [76.20]	2.900 [73.66]	8-534998-0	7-535598-2	7-535585-2
62	3.100 [78.74]	3.000 [76.20]	8-534998-1	8-535598-2	8-535585-2
64	3.200 [81.28]	3.100 [78.74]	8-534998-2	8-535598-3	8-535585-3
66	3.300 [83.82]	3.200 [81.28]	8-534998-3	8-535598-4	8-535585-4
68	3.400 [86.36]	3.300 [83.82]	8-534998-4	8-535598-5	8-535585-5
70	3.500 [88.90]	3.400 [86.36]	8-534998-5	8-535598-6	8-535585-6
72	3.600 [91.44]	3.500 [88.90]	8-534998-6	8-535598-7	8-535585-7
74	3.700 [93.98]	3.600 [91.44]	8-534998-7	8-535598-8	8-535585-8
76	3.800 [96.52]	3.700 [93.98]	8-534998-8	8-535598-9	8-535585-9
78	3.900 [99.06]	3.800 [96.52]	8-534998-9	9-535598-0	9-535585-0
80	4.000 [101.60]	3.900 [99.06]	9-534998-0	7-535598-3	7-535585-3

Notes: 1. Tyco Electronics recommends mating gold or duplex plated headers with duplex plated receptacle assemblies.

2. To obtain the minimum mating post length, add .020 [0.51] (not including the post lead in chamfer) to the maximum point-of-contact dimension.

Note: All part numbers are RoHS compliant.