

PRODUCT NUMBER
SEE SHT. 2

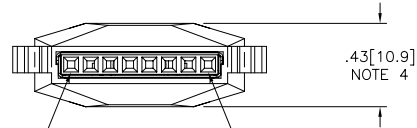
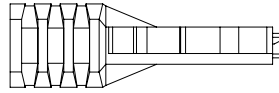
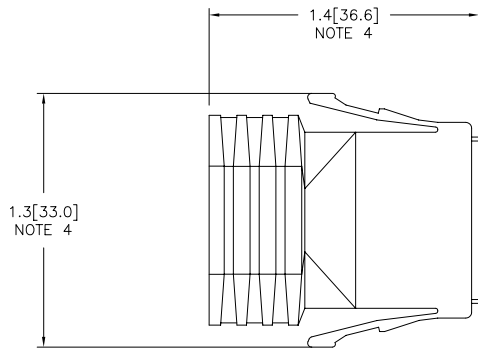

POSTION #1

POSTION #8

mat'l. code		surface	tolerance	projection	product family
		ISO 1302	ISO 406		LATCH-N-LOK
			ISO 1101		title
ltr	ecn no	dr	date	tolerances unless otherwise specified	
D	v91916	TGD	10/7/99	.XX±.01/.3	
E	v92065	RGD	10/29/99	angles linear .XXX±.005/.13	1x8 LATCH-N-LOK 360° SHIELDED
F	v01017	TFG	5/15/00	0°±2° .XXXX±.0020/.051	PLUG CONN. KIT W/O PV'S
G	v01050	TFG	6/5/00	dr M. HERNANDEZ 12/03/04	scale 1:1
H	v01093	TFG	7/6/00	engr M. BARRIOS 12/03/04	
J	M04-0229	MHT	12/03/04	chr M. BARRIOS 12/03/04	
K	M06-0365	AGS	9/20/06	appd M. BARRIOS 12/03/04	type Product Customer Drawing
sheet index	revision sheet	K	K	K	
		1	2	3	

74903-TUVLF

U	COLOR	
01	LT GRAY	OBS
02	OFF WHITE	
03	DK GRAY	OBS
04	BLACK	
05	SLATE GRAY	OBS
07	SILVER GRAY	
08	PEARL WHITE	OBS
09	PEBBLE GRAY	

T	HOLE DIA.
7	.265/6.73
9	.312/7.92

EXAMPLE

74903-707LF: IS A 1x8 REAR EXIT PLUG IN SILVER GRAY WITH A CABLE EXIT HOLE SIZE OF .265 [6.73] CABLE RANGE ,

mat'l. code		surface	tolerance	projection	product family
ISO 1302		ISO 1302	ISO 406		LATCH-N-LOK
ISO 1101		ISO 1101	ISO 1101		
ltr	ecn	no	dr	date	title
K					1x8 LATCH-N-LOK 360° SHIELDED PLUG CONN. KIT W/O PV'S
		tolerances unless otherwise specified			
		angles	linear		scale 1:1
		0°±2'	.XX±.01/.3		
			.XXX±.005/.13		
			.XXXX±.0020/.051		
		dr	M. HERNANDEZ	12/03/04	dwg no
		engr	M. BARRIOS	12/03/04	sheet 2 of 3
		chr	M. BARRIOS	12/03/04	size
		appd	M. BARRIOS	12/03/04	A3
					type
					Product Customer Drawing
sheet	revision				
index	sheet				

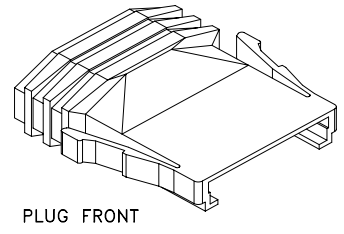
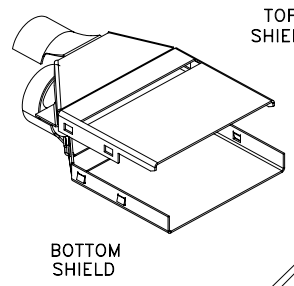
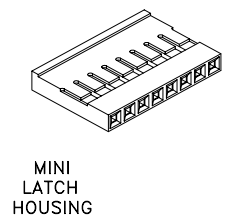
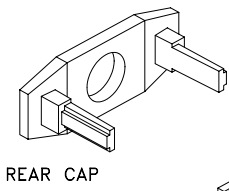

NOTES:

- ① EACH KIT CONTAINS ONE EACH OF THE FOLLOWING COMPONENTS
LATCH-N-LOK PLUG
LATCH-N-LOK END CAP
MINI LATCH HOUSING
360° SHIELD CANS.
2. COMPONENTS ARE BULK PACKAGED WITH 100 pcs. OF A COMPONENT PER BAG. PVC'S MUST BE ORDERED SEPARATELY.
3. MATERIALS USED: PLUGS AND CAPS ARE MOLDED IN POLYCARBONATE. THE MINI LATCH HOUSING ARE MOLDED IN NYLON. COLOR IS BLACK. THE SHIELD CAN IS 3/4 HARD BRASS PLATED WITH 2.5um MIN. BRIGHT TIN. 1.0um MIN. NICKEL UNDERPLATE.
- ④ DIMENSIONS ARE APPROXIMATE AND REFLECT PLUG IN UNLATCHED STATE.
5. PART NUMBERS WITH LF IN THE END ARE LEAD FREE.
6. THIS PRODUCT MEETS EUROPEAN UNION DIRECTIVES AND OTHER COUNTRY REGULATION AS DESCRIBED IN GS-22-008.

mat'l. code		surface	tolerance	projection	product family
ISO 1302		ISO 406	ISO 1101		LATCH-N-LOK
ltr	ecn no dr date	tolerances unless otherwise specified			title
K		angles	.XX±.01/.3	INCH/MM	1X8 LATCH-N-LOK 360° SHIELDED PLUG CONN. KIT W/O PV'S
		linear	.XXX±.005/.13	scale 1:1	dwg no 74903 sheet 3 of 3 size A3
		0°±2°	.XXXX±.0020/.051		type Product Customer Drawing
		dr	M. HERNANDEZ 12/03/04		
		engr	M. BARRIOS 12/03/04		
		chr	M. BARRIOS 12/03/04		
		appd	M. BARRIOS 12/03/04		
sheet index	revision sheet				