

Wire to Board Connectors

Dynamic Series Connectors/D-3000 Series

D-3200M—Modular Type

Mating Dimensions

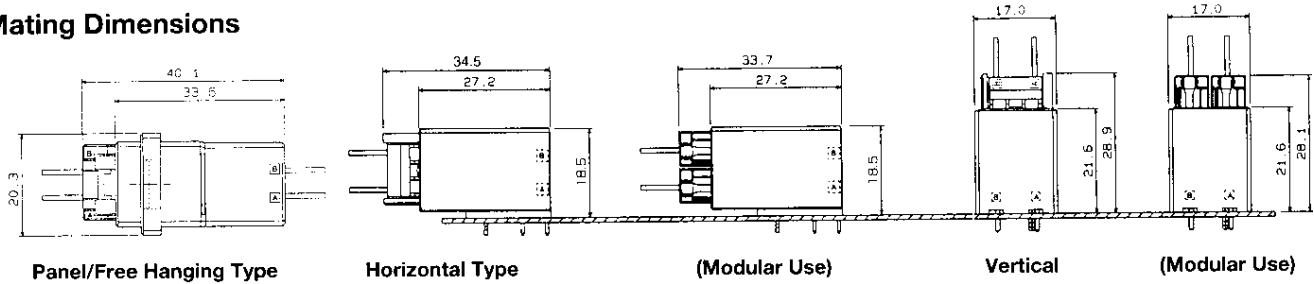

External Dimensions

■ Receptacle Housing

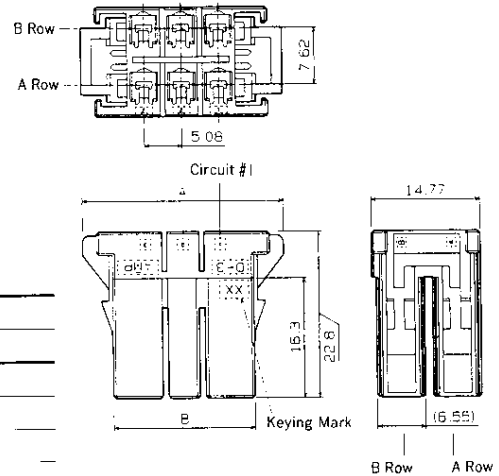
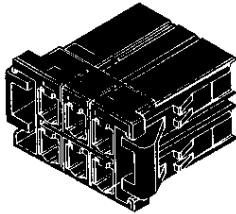

No. of Pos.	Part Number	Dimensions	
		A	B
6	□-178129-6	27.30	19.24
10	□-917659-5	37.46	29.40
12	□-917659-6	42.54	34.48
20	□-917659-8	62.86	54.80

■ Tab Housing

Panel Type

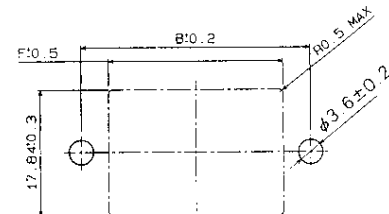
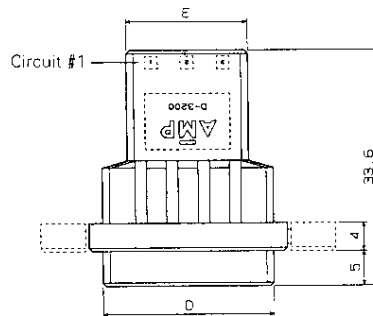
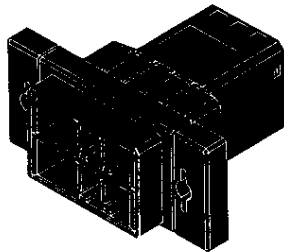

Panel Cutout

When mounting panel from the front, apply clamping torque of less than 49N.

Free Hanging Type

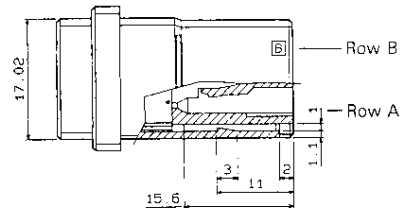
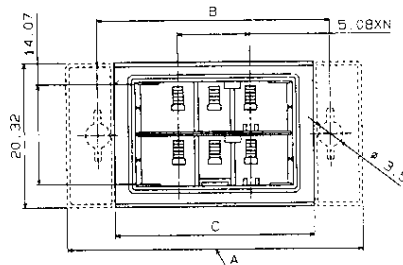
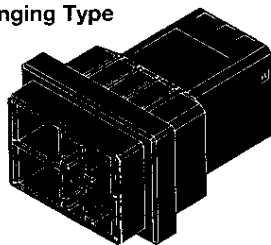

No. of Pos.	Part Number		Dimensions					
	Panel Type	Free Hanging Type	A	B	C	D	E	F
6	□-179555-3	□-179554-3	41.91	33	28.11	24.16	17.16	25
12	□-179555-6	□-179554-6	57.91	49	43.35	39.4	32.4	41
20	□-179555-8	—	78.23	70	—	59.72	52.72	61