

Product Facts

- High density, 0.8 mm centerline
- Vertical and right angle surface mount receptacles
- Dual-row housing, 4-40 positions
- Dual-beam receptacle contact provides reliable, redundant points of contact
- Crimp Snap-In plug contact utilizing the "F"-Crimp for 28 & 30 AWG discrete wire
- Detent style latching
- Shrouding and polarization
- Strain relief option available
- Application tooling utilizes mini-applicators
- Plug contact serviceability
- Receptacles packaged in embossed tape, per EIA 481 standards
- Recognized under the Component Program of Underwriters Laboratories., File No. E28476 

Technical Documents

Product Specification
108-1955

Application Specification
114-13051

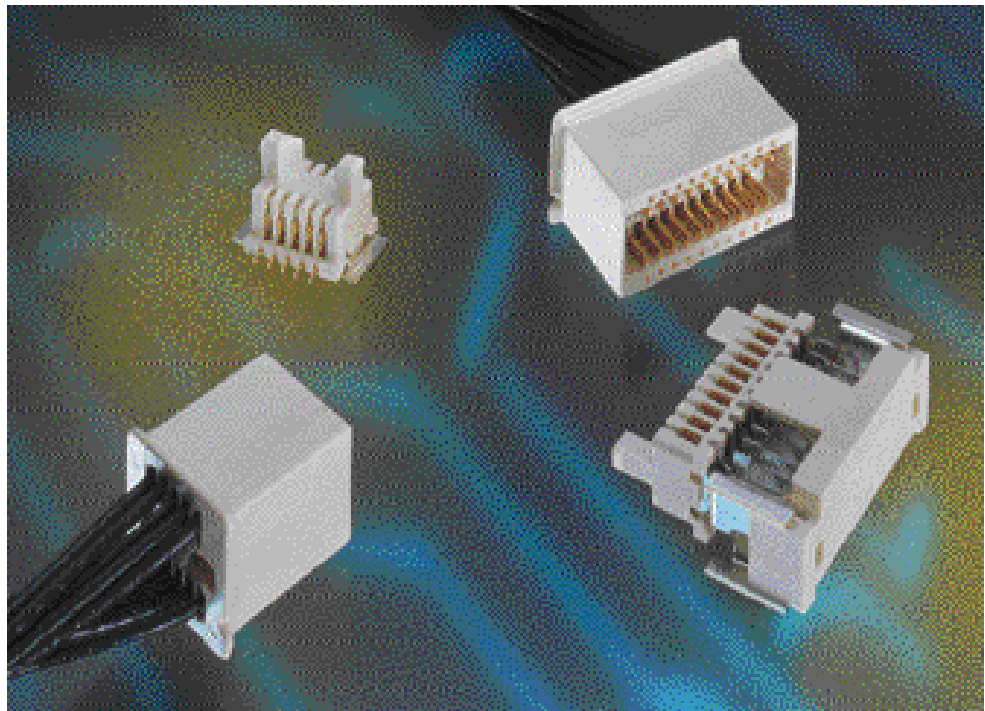

The AMPMODU Micro Interconnect System is the next generation family of products that has been designed around a high density, 0.8 mm centerline configuration. The first release in the series is the cable-to-board, discrete wire system, available in 4 through 40 positions.

Due to the small scale of the product, the contact interface is opposite vs. that of the larger-centerline AMPMODU product. For Micro Interconnect, the wire is crimped to the more-robust plug blade contact rather than the receptacle contact.

The surface-mount receptacle connectors are available in both vertical and right angle configurations. They are manufactured using automated equipment and later handled with automatic placement equipment at the customer's site. Both the vertical and right-angle receptacles provide ample

surface area for vacuum pick-up. The center section of the vertical receptacle between the dual receptacle rows is the vacuum surface. For the right angle receptacle, the vacuum surface is an integral feature of the plastic organizer component.

The plug half of Micro Interconnect likewise consists of 4 through 40 positions. It utilizes 28 to 30 gauge discrete wire for the crimp contacts. A special feature of this housing is the flange around the perimeter, which provides a convenient gripping feature. This flange is notched in one location to provide a convenient Pin No. 1 indicator.

An optional strain relief is also available to help gather the individual wires at the plug wire exit. The strain relief serves to better protect the terminated leads in more rigorous applications.

Performance Specifications

Electrical Characteristics:

- Contact Current Rating:
1 ampere - 28 AWG
0.75 ampere - 30 AWG
- Termination Resistance:
25 milliohms max.

Environmental Characteristics:

- Operating Temperature:
-55°C to + 85°C

Need more information?

Call Technical Support at the numbers listed below.

Technical Support is staffed with specialists well versed in Tyco Electronics products. They can provide you with:

- Technical Support
- Catalogs
- Technical Documents
- Product Samples
- Tyco Electronics Authorized Distributor Locations

© 2003 by Tyco Electronics Corporation. All Rights Reserved AMP, AMPMODU, and TYCO are trademarks. Other products, logos, and company names mentioned herein may be trademarks of their respective owners.

METRIC
Dimensions are millimeters over inches.

Receptacle Assembly, Vertical Surface Mount

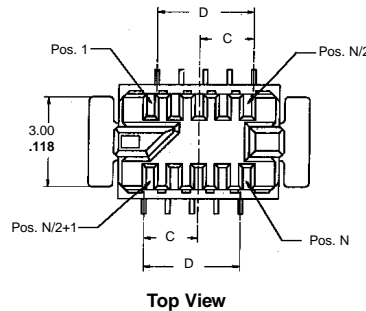
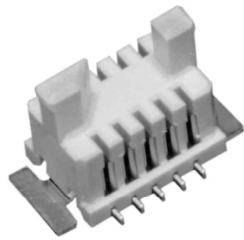

Top View

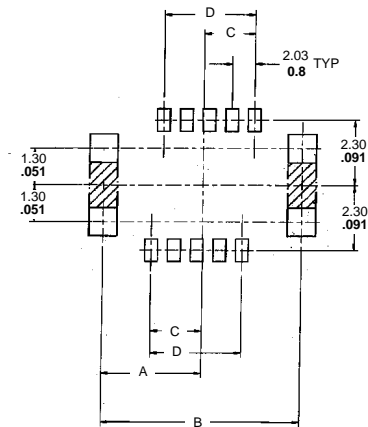

PC Board Layout

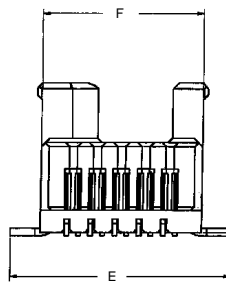

Side View

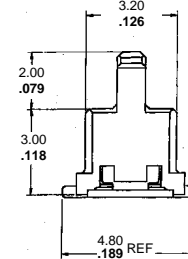

End View

Material and Finish

Housing — Thermoplastic (Beige), 94V-0 Rated

Contacts — Copper alloy, duplex plated .000030 [0.00076] gold in contact area, .000005 [0.00013] gold in solder area, with entire contact underplated .000050 [0.00127] nickel

Boardlocks — Copper alloy, pre-plated .000150 [0.0038] bright tin-lead, underplated .000050 [0.00127] nickel.

Related Product Data

Application Tooling — page 6

No. of Positions	Dimensions						Part Number
	A	B	C	D	E	F	
4	2.31 0.091	4.62 0.182	0.60 0.023	0.80 0.031	4.95 0.195	2.94 0.116	1445339-1
6	2.71 0.107	5.42 0.213	1.00 0.039	1.60 0.063	5.75 0.226	3.74 0.147	1375870-1
8	3.11 0.122	6.22 0.245	1.40 0.055	2.40 0.094	6.55 0.258	4.54 0.179	1375870-2
10	3.51 0.138	7.02 0.276	1.80 0.071	3.20 0.126	7.35 0.289	5.34 0.210	1375870-3
12	3.91 0.154	7.82 0.308	2.20 0.087	4.00 0.157	8.15 0.321	6.14 0.242	1375870-4
14	4.31 0.170	8.62 0.339	2.60 0.102	4.80 0.189	8.95 0.352	6.94 0.273	1375870-5
16	4.71 0.185	9.42 0.371	3.00 0.118	5.60 0.220	9.75 0.384	7.74 0.305	1375870-6
18	5.11 0.201	10.22 0.402	3.40 0.134	6.40 0.252	10.55 0.415	8.54 0.336	1375870-7
20	5.51 0.217	11.02 0.434	3.80 0.150	7.20 0.283	11.35 0.447	9.34 0.368	1375870-8
22	5.91 0.233	11.82 0.465	4.20 0.165	8.00 0.315	12.15 0.478	10.14 0.399	1375870-9
24	6.31 0.248	12.62 0.497	4.60 0.181	8.80 0.346	12.95 0.510	10.94 0.431	1-1375870-0
26	6.71 0.264	13.42 0.528	5.00 0.197	9.60 0.378	13.75 0.541	11.74 0.462	1-1375870-1
28	7.11 0.280	14.22 0.560	5.40 0.213	10.40 0.409	14.55 0.573	12.54 0.494	1-1375870-2
30	7.51 0.296	15.02 0.591	5.80 0.228	11.20 0.441	15.35 0.604	13.34 0.525	1-1375870-3
32	7.91 0.311	15.82 0.623	6.20 0.244	12.00 0.472	16.15 0.636	14.14 0.557	1-1375870-4
34	8.31 0.327	16.62 0.654	6.60 0.260	12.80 0.504	16.95 0.667	14.94 0.588	1-1375870-5
36	8.71 0.343	17.42 0.686	7.00 0.276	13.60 0.535	17.75 0.699	15.74 0.620	1-1375870-6
38	9.11 0.359	18.22 0.717	7.40 0.291	14.40 0.567	18.55 0.730	16.54 0.651	1-1375870-7
40	9.51 0.374	19.02 0.749	7.80 0.307	15.20 0.598	19.35 0.762	17.34 0.683	1-1375870-8

Plug Housing

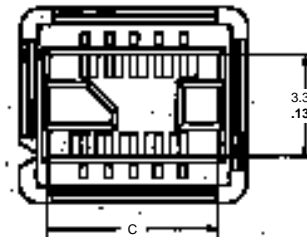

Top View

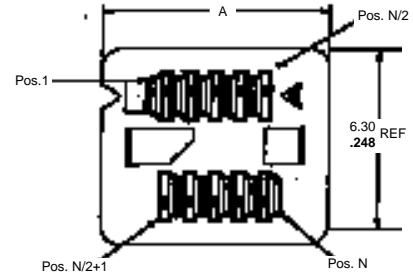

Bottom View

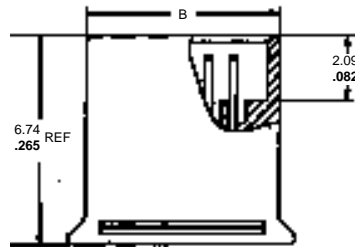

Side View

Material and Finish

Housing — Thermoplastic (beige), 94V-0 rated

Related Product Data — Contacts used with - pg. 5

Related Product Data

Application Tooling — page 6

No. of Positions	Dimensions			Part Number
	A	B	C	
4	4.95 0.195	3.85 0.152	3.10 0.122	1445340-1
6	5.75 0.226	4.65 0.183	3.90 0.154	1375875-1
8	6.55 0.258	5.45 0.215	4.70 0.185	1375875-2
10	7.35 0.289	6.25 0.246	5.50 0.217	1375875-3
12	8.15 0.321	7.05 0.278	6.30 0.248	1375875-4
14	8.95 0.352	7.85 0.309	7.10 0.280	1375875-5
16	9.75 0.384	8.65 0.341	7.90 0.311	1375875-6
18	10.55 0.415	9.45 0.372	8.70 0.343	1375875-7
20	11.35 0.447	10.25 0.404	9.50 0.374	1375875-8
22	12.15 0.478	11.05 0.435	10.30 0.406	1375875-9
24	12.95 0.510	11.85 0.467	11.10 0.437	1-1375875-0
26	13.75 0.541	12.65 0.498	11.90 0.469	1-1375875-1
28	14.55 0.573	13.45 0.530	12.70 0.500	1-1375875-2
30	15.35 0.604	14.25 0.561	13.50 0.531	1-1375875-3
32	16.15 0.636	15.05 0.593	14.30 0.563	1-1375875-4
34	16.95 0.667	15.85 0.624	15.10 0.594	1-1375875-5
36	17.75 0.699	16.65 0.656	15.90 0.626	1-1375875-6
38	18.55 0.730	17.45 0.687	16.70 0.657	1-1375875-7
40	19.35 0.762	18.25 0.719	17.50 0.689	1-1375875-8

Receptacle Assembly, Right Angle, Surface Mount

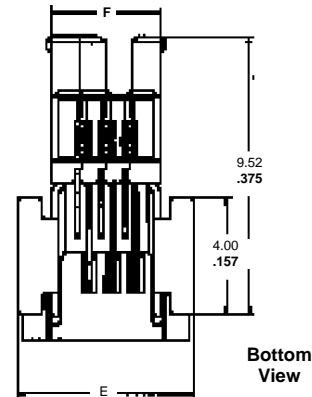
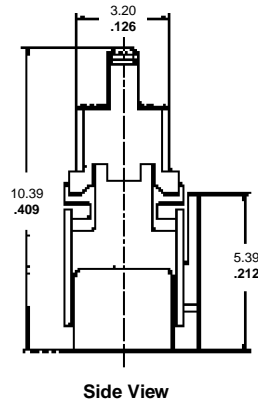
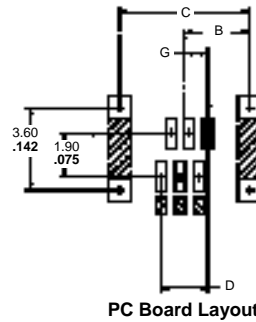
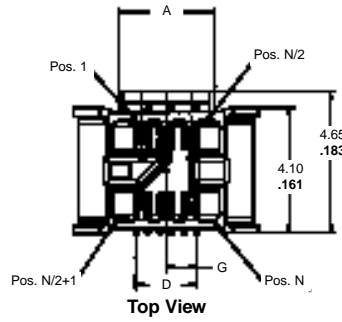

Material and Finish

Housing and Organizer —

Thermoplastic (beige), 94V-0 rated

Contacts — Copper alloy, duplex plated .000030 [0.00076] gold in contact area, .000100 [0.00254] matte tin lead in solder area, with entire contact underplated .000050 [0.00127] nickel.

Boardlocks — Copper alloy, pre-plated .000150 [0.0038] bright tin-lead, underplated .000050 [0.00127] nickel.

Related Product Data

Application Tooling — page 6

No. of Positions	Dimensions							Part Number
	A	B	C	D	E	F	G	
4	2.32 0.091	2.41 0.095	4.82 0.190	1.20 0.047	5.21 0.205	2.94 0.116	0.60 0.024	1445940-1
6	3.12 0.123	2.81 0.111	5.62 0.221	2.00 0.079	6.01 0.237	3.74 0.147	1.00 0.039	1445297-1
8	3.92 0.154	3.21 0.126	6.42 0.253	2.80 0.110	6.81 0.268	4.54 0.179	1.40 0.055	1445297-2
10	4.72 0.186	3.61 0.142	7.22 0.284	3.60 0.142	7.61 0.300	5.34 0.210	1.80 0.071	1445297-3
12	5.52 0.217	4.01 0.158	8.02 0.316	4.40 0.173	8.41 0.331	6.14 0.242	2.20 0.087	1445297-4
14	6.32 0.249	4.41 0.174	8.82 0.347	5.20 0.205	9.21 0.363	6.94 0.273	2.60 0.102	1445297-5
16	7.12 0.280	4.81 0.189	9.62 0.379	6.00 0.236	10.01 0.394	7.74 0.305	3.00 0.118	1445297-6
18	7.92 0.312	5.21 0.205	10.42 0.410	6.80 0.268	10.81 0.426	8.54 0.336	3.40 0.134	1445297-7
20	8.72 0.343	5.61 0.221	11.22 0.442	7.60 0.299	11.61 0.457	9.34 0.368	3.80 0.150	1445297-8
22	9.52 0.375	6.01 0.237	12.02 0.473	8.40 0.331	12.41 0.489	10.14 0.399	4.20 0.165	1445297-9
24	10.32 0.406	6.41 0.252	12.82 0.505	9.20 0.362	13.21 0.520	10.94 0.431	4.60 0.181	1-1445297-0
26	11.12 0.438	6.81 0.268	13.62 0.536	10.00 0.394	14.01 0.552	11.74 0.462	5.00 0.197	1-1445297-1
28	11.92 0.469	7.21 0.284	14.42 0.568	10.80 0.425	14.81 0.583	12.54 0.494	5.40 0.213	1-1445297-2
30	12.72 0.501	7.61 0.300	15.22 0.599	11.60 0.457	15.61 0.615	13.34 0.525	5.80 0.228	1-1445297-3
32	13.52 0.532	8.01 0.315	16.02 0.631	12.40 0.488	16.41 0.646	14.14 0.557	6.20 0.244	1-1445297-4
34	14.32 0.564	8.41 0.331	16.82 0.662	13.20 0.520	17.21 0.678	14.94 0.588	6.60 0.260	1-1445297-5
36	15.12 0.595	8.81 0.347	17.62 0.694	14.00 0.551	18.01 0.709	15.74 0.620	7.00 0.276	1-1445297-6
38	15.92 0.627	9.21 0.363	18.42 0.725	14.80 0.583	18.81 0.741	16.54 0.651	7.40 0.291	1-1445297-7
40	16.72 0.658	9.61 0.378	19.22 0.757	15.60 0.614	19.61 0.772	17.34 0.683	7.80 0.307	1-1445297-8

Part Number 1375876-2



Material and Finish

Contacts—Copper alloy, duplex plated
.000030 [0.00076] gold in contact area,
.000100 [0.00254] bright tin-lead in crimp
area, with entire contact underplated
.000050 [0.00127] nickel

Related Product Data

Housings used with — pg. 3
Application tooling — pg. 6

Related Product Data

Application Tooling — page 6

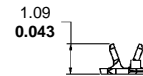
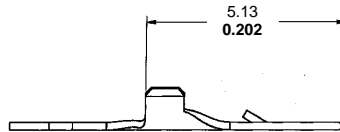
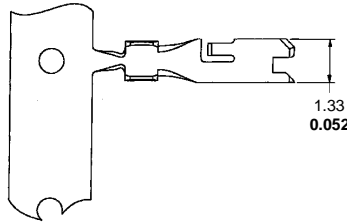

Wire Size Range	Insulation Diameter (Max.)
30-28	0.60 0.024

Hermaphroditic Strain Relief

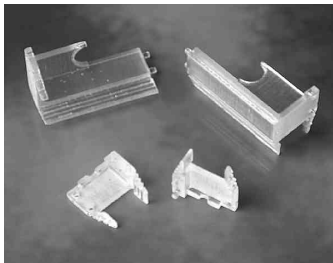

Material and Finish

Housing—Thermoplastic (beige), 94V-0 rated

Related Product Data

Housings used with - pg. 3

Related Product Data

Application Tooling — page 6

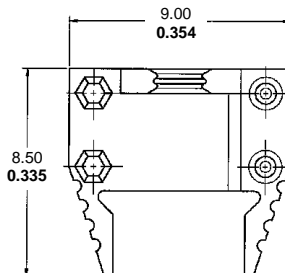
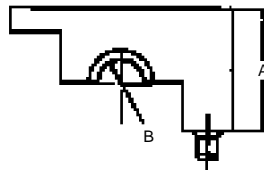

No. of Positions	Dimensions		Part Number
	A	B	
4	2.60 0.102	1.15 0.045	1445976-1
6	3.40 0.134	1.37 0.054	1445976-2
8	4.20 0.165	1.59 0.063	1445976-3
10	5.00 0.197	1.80 0.071	1445976-4
12	5.80 0.228	2.03 0.080	1445976-5
14	6.60 0.260	2.24 0.088	1445976-6
16	7.40 0.291	2.46 0.097	1445976-7
18	8.20 0.323	2.68 0.106	1445976-8
20	9.00 0.354	2.90 0.114	1445976-9
22	9.80 0.386	3.00 0.118	1-1445976-0
24	10.60 0.417	3.10 0.122	1-1445976-1
26	11.40 0.449	3.20 0.126	1-1445976-2
28	12.20 0.480	3.30 0.130	1-1445976-3
30	13.00 0.512	3.40 0.134	1-1445976-4
32	13.80 0.543	3.50 0.138	1-1445976-5
34	14.60 0.575	3.60 0.142	1-1445976-6
36	15.40 0.606	3.70 0.146	1-1445976-7
38	16.20 0.638	3.80 0.150	1-1445976-8
40	17.00 0.669	3.90 0.154	1-1445976-9

Note: Two pieces required per connector assembly.

Application Tooling

Tooling

- 1385161-3** AMP-O-LECTRIC G Press Mini Applicator
- 1385161-2** AMP-O-LECTRIC K Press Mini Applicator
- 528367-3** Semi-Automatic Electric Wire Stripper
- 1490583-1** Insertion Tool
- 1490584-1** Extraction Tool
- 1583957-1** Unmating Tool

Technical Documents

Product Specification: 108-1955
Application Specification: 114-13051

Application Tooling/Instruction Sheet Cross Reference

Tool Part No.	Instruction Sheet
1385161-3	408-3040
1385161-2	408-3040
1490583-1	408-8583
1490584-1	408-8584
1583957-1	408-8685

Engineering Notes

