



Fiber Optic Products

HS
dy

 **Tyco Electronics**
Our commitment. Your advantage.

Introduction

Tyco Electronics is a globally recognized preeminent supplier of fiber optic connectors and interconnection devices. We offer an extensive variety of optical connectors, cable assemblies, fiber management systems,

and optoelectronic active and passive components — connectivity solutions. With unparalleled, world-class technologies and high quality products, Tyco Electronics demonstrates its commitment to

satisfying all types of customers. Our sales service and support is available globally via an extensive network of Tyco Electronics sales engineers, field program managers, and applications engineers.

Additional Fiber Optic products available through Tyco Electronics:

Rugged Fiber Optic products can be found in **Catalog 1308940**
(Connectors for Aerospace, Defense and Marine)

Netconnect Fiber Optic products can be found in **Catalog 82164**
(AMP Netconnect Product Catalog)

Disclaimer

While Tyco Electronics Corporation and its affiliates referenced herein ("Tyco Electronics") have made every reasonable effort to ensure the accuracy of the information in this catalog, Tyco Electronics does not guarantee that it is error-free, nor does Tyco Electronics make any other representation, warranty or guarantee that the information is accurate, correct, reliable or current. Tyco Electronics reserves the right to make any adjustments to the information contained herein at any time without notice. Tyco Electronics expressly disclaims all implied warranties regarding the information contained herein, including, but not limited to, any implied warranties of merchantability or fitness for a particular purpose. Tyco Electronics' only obligations are those in the Tyco Electronics Standard Terms and Conditions of Sale, and in no case will Tyco Electronics be responsible for any incidental, indirect, or consequential

damages arising from the sale, resale, use, or misuse of its products. Users should independently evaluate the suitability of, and test each product for, their application.

The dimensions, specifications, designs, construction, materials and processes in this catalog are for reference purposes only and are subject to change without notice. Please consult Tyco Electronics for the most current product information.

The export of certain Tyco Electronics products is restricted by the Arms Export Control Act (Title 22, U.S.C. Sec 2751, et seq.) or the Export Administration Act of 1979, as amended (Title 50, U.S.C., App. 2401 et seq.). Orders may be subject to export approval by the U.S. Government. Buyer must comply with all applicable export laws of all applicable jurisdictions.

Copyright 2010, 2007, 2006 and 2004 Tyco Electronics Corporation. All Rights Reserved.

AMP, AMP NETCONNECT, AMPTRAC, ARMOR-LIGHT, CORELINK, DUALAN, FIBRBOSS, FIST, FOSEC, FSD, LC SECURE, LIGHTCRIMP, LIGHTCRIMP PLUS, LIGHTRAY, LIGHTRAY MPX, LIGHTRAY OFX, MPO SECURE, MT-RJ SECURE, NETCONNECT, PARALIGHT, PARA-OPTIX, PRO BEAM, PRO-CRIMPER, TE (logo) and Tyco Electronics are trademarks of the Tyco Electronics group of companies and its licensors.

Other products, logos, and company names mentioned herein may be trademarks of their respective owners.

See inside back cover for Global Contacts and phone numbers.

Restriction on the use of Hazardous Substances (RoHS)

At Tyco Electronics, we're ready to support your RoHS requirements. We've assessed more than 1.5 million end items/components for RoHS compliance, and issued new part numbers where any change was required to eliminate the restricted materials. Part numbers in this catalog are identified as:

RoHS Compliant — Part numbers in this catalog are RoHS Compliant, unless marked otherwise. These products comply with European Union Directive 2002/95/EC as amended 1 January 2006 that restricts the use of lead, mercury, cadmium, hexavalent chromium, PBB, and PBDE in certain electrical and electronic products sold into the EU as of 1 July 2006.

NOTE: For purposes of this Catalog, included within the definition of RoHS Compliant are products that are clearly "Out of Scope" of the RoHS Directive such as hand tools and other non-electrical accessories.

Non-RoHS Compliant — These part numbers are identified with a "◆" symbol. These products do not comply with the material restrictions of the European Union Directive 2002/95/EC.

NOTE: Information regarding RoHS compliance is provided based on reasonable inquiry of our suppliers and represents our current actual knowledge based on the information provided by our suppliers. This information is subject to change. For latest compliance status, refer to our website referenced at right.

Getting the Information You Need

Our comprehensive on-line RoHS Customer Support Center provides a forum to answer your questions and support your RoHS needs. A RoHS FAQ (Frequently Asked Questions) is available with links to more detailed information. You can also submit RoHS questions and receive a response within 24 hours during a normal work week. The Support Center also provides:

- Cross-Reference from Non-compliant to Compliant Products
- Ability to browse RoHS Compliant Products in our on-line catalog
- Downloadable Technical Data Customer Information Presentation
- More detailed information regarding the definitions used above
- So whatever your questions when it comes to RoHS, we have the answers at www.tycoelectronics.com/leadfree



WHAT'S NEW IN THIS ISSUE

PARALIGHT Active Optical Assemblies Pages 8-11



40Gb/s QDR QSFP+ Cable Assemblies

- 100 meters + length
- Functions like a standard electrical cable
- Low latency – 15.84pc + cable
- 1/3 size and 1/10 weight of copper assemblies



20Gb/s DDR QSFP and CX-4 Cable Assemblies

- Reach 150 meters and greater
- Available in QSFP, CX-4, and hybrid (QSFP-CX-4) configurations

Fiber to the Antenna Solutions Pages 71-96

- Designed for next generation WiMax and LTE Applications
- Robust designs for external antenna applications
- Broad range of solutions including traditional products and direct Tx mating solutions



ODVA Compliant Connector — Economic Robust Design

- All plastic
- IP-67 rated
- Rated for outdoor applications



ODC – Traditional Fiber to the Antenna Applications

- Robust all metal connector
- Significant product already deployed
- Available in Duplex or Quad



Direct Attach

- Mates directly through the box to the Tx
- Eliminates one cable assembly internal to the antenna box

10 Gigabit Products Pages 12-13



- Supports IEEE 802.3ae 10GBASE-SR and 10GBASE-LX4 to 300m
- Complies with OM-3 fiber specifications of 2nd edition ISO 11801
- Allows Gigabit Ethernet 1000BASE-SX to 1000m
- Supports 50/125um legacy LED and laser-based applications
- This section outlines all the parts needed for an end-to-end system with 10 Gigabit cable assemblies and connectors

MPO on Round Cable Page 14



- Flexible round outer jacket for easier installation and cable routing
- Same standards compliant performance
- Fiber counts up to 24 for standard MPO, and up to 72 fibers using high density PARA-OPTIX assemblies

ODC is a product and trademark of HUBER+SUHNER AG.
ODVA is a trademark of ODVA, Inc.

TABLE OF CONTENTS

Introduction 2

What's New In This Issue 3

Table of Contents 4-6

Section 1 — Cable Assemblies & Backplane Interconnects 7-27

PARALIGHT Active Optical Cable Assemblies 8-11

10 Gigabit Fiber Optic Products Overview

 MTP/MPO Round Cable Assemblies 12

 LC Cable Assemblies 12

 LC and SC Connector Kits 13

 LC and SC Adapters 13

MPO Cable Assemblies

 MTP/MPO Round Cable Assemblies 14

 MTP/MPO Breakout Cable Assemblies 15

 MPO Connectors and Adapters 16

 PARA-OPTIX High Density Cable Assemblies 17

MPX Backplane Solutions 18-26

 LIGHTRAY MPX Connector 18

 Bulkhead Coupling Adapter 19

 Backplane Housings and Adapters 19-21

 Fanout Assemblies 22

 Mini Trunk Assemblies 22

 Trunk Assemblies 22

 Singlemode — Standard Loss LIGHTRAY MPX Assemblies 23, 24

 Dust Covers, Cleaning Kit and Connector Microscope Adapters 25

 Cleaners 26

Simplex and Duplex Fiber Assemblies 27

Section 2 — Connectors, Adapters, Tooling & Accessories 29-60

LC Connectors 30-35

 LC Connector Kits 30, 31

 LC Connector Components 32, 33

LC Adapters 34, 35

SC Connectors 36-38

 SC Connector Kits 36

 SC Connector Components 37, 38

SC Adapters 39-41

 SC to SC Adapters 39, 40

 SC to ST Hybrid Adapters 40, 41

 Slide-On Retractable Cover for SC Simplex or Duplex Applications 41

ST Connectors and Adapters 42-45

 ST Connector Kits 42

 ST Connector Components 43

 ST Active Device Mounts 43

TABLE OF CONTENTS (Continued)

FC Connectors 44
FC Connector Kits 44

FC Adapters 44, 45
FC to FC Adapters 44
FC to ST Hybrid Adapters 45
FC to SC Hybrid Adapters 45

ESCON Connector 46

FSMA Connector 46

FSMA Adapter 46

MT-RJ SECURE Connectors 47

LIGHTCRIMP PLUS No Epoxy, No Polish LC, SC and ST Connectors 48

Tooling 49-56

Section 3 — Fiber Management & Capabilities **57-62**
Fiber Management Systems 58
LIGHTRAY OFX Optical Fiber Circuit Assemblies 59
On Card Fiber Management 60
Enclosures and Customer Interface Panels 61
Laser Process for Fibershape Products 62

Section 4 — Other Products and Capabilities **63-70**
AMP NETCONNECT Premises Wiring Products 64
Telecom Outside Plant Products 65
Attenuators 66-69
Switches 70

Section 5 — Fiber to the Antenna Rugged Interconnect **71-96**
Introduction 72
FULLAXS Fiber to the Antenna Rugged Interconnect 73
ODC™ Plug and Socket Cable Assemblies 74-78
Max-Travel Fiber to the Antenna Rugged Interconnect 79
LC ODVA Connectors 80, 81
PRO BEAM Expanded Beam Rugged Optics Products 82-96

Part Number Index **97, 98**

Tyco Electronics Global Locations **99**

ODC is a product and trademark of HUBER+SUHNER AG.

Engineering Notes

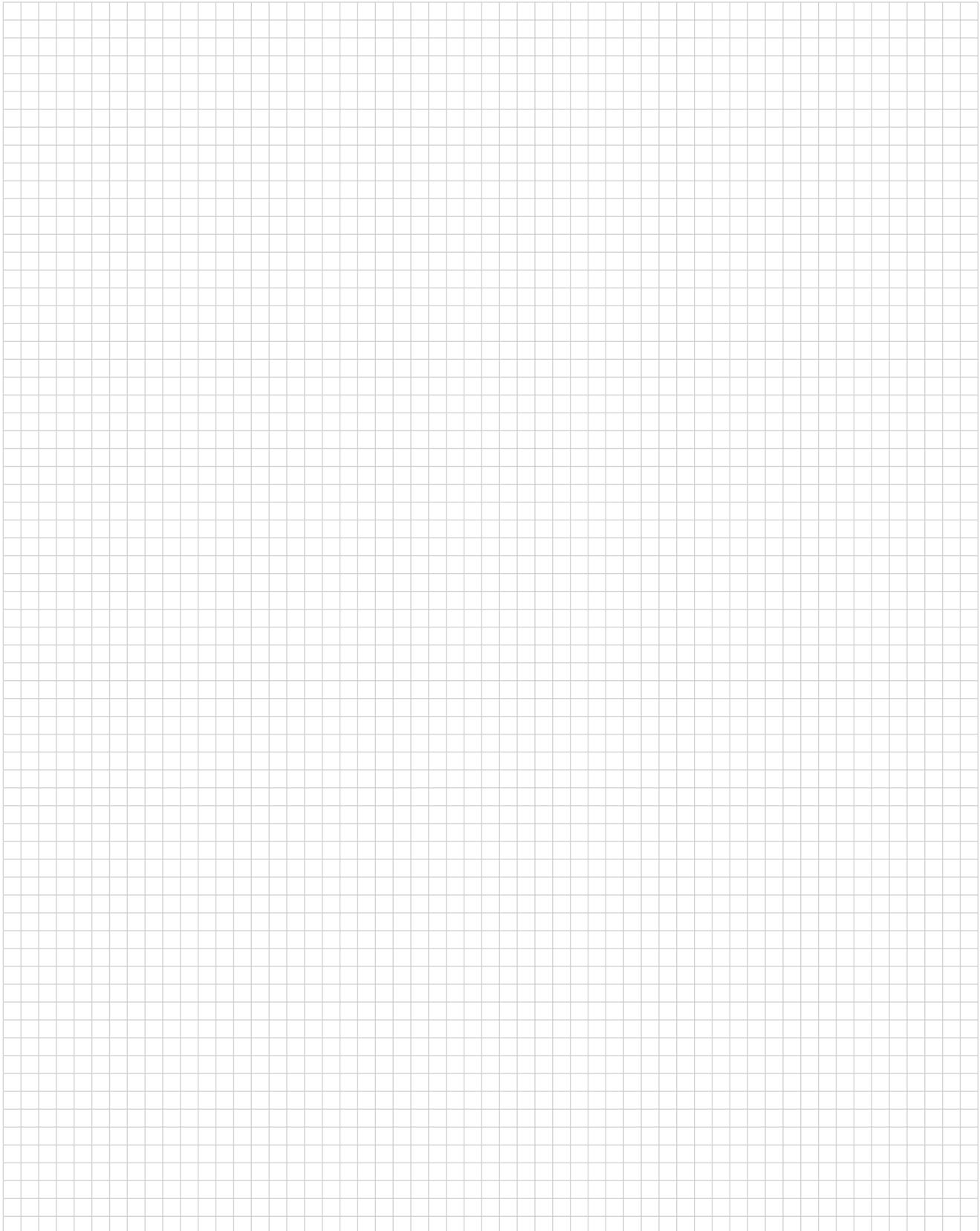

Table of Contents

Section 1 — Cable Assemblies & Backplane Interconnects	7-27
PARALIGHT Active Optical Cable Assemblies	8-11
10 Gigabit Fiber Optic Products Overview	
MTP/MPO Round Cable Assemblies	12
LC Cable Assemblies	12
LC and SC Connector Kits	13
LC and SC Adapters	13
MPO Cable Assemblies	
MTP/MPO Round Cable Assemblies	14
MTP/MPO Breakout Cable Assemblies	15
MPO Connectors and Adapters	16
PARA-OPTIX High Density Cable Assemblies	17
LIGHTRAY MPX Backplane Solutions	18-26
LIGHTRAY MPX Connector	18
Bulkhead Coupling Adapter	19
Backplane Housings and Adapters	19-21
Fanout Assemblies	22
Mini Trunk Assemblies	22
Trunk Assemblies	22
Singlemode — Standard Loss LIGHTRAY MPX Assemblies	23, 24
Dust Covers, Cleaning Kit and Connector Microscope Adapters	25
Cleaners	26
Simplex and Duplex Fiber Assemblies	27

PARALIGHT Active Optical Cable Assemblies

Product Facts

- 4 transmit and 4 receive channels at 5 Gb/s and 10 Gb/s per channel
- Industry standard (SFF-8470) electrical connector (aka InfiniBand 4X, IB 4X, CX4*, Fibre Channel) and QSFP/QSFP+ Connector
- Internally terminated optics — no optical connector to clean
- Differential data I/O per InfiniBand version 1.2.1
- Asynchronous, internally AC coupled inputs and outputs
- Passively cooled design — low thermal resistance heat path from chip to connector shell
- Small diameter cable (3.0 mm)
- Light weight
- Tight bend radius
- Following configurations also available. Contact your Tyco Electronics sales representative for details
 - SFP+ 10 Gb/s single lane
 - CXP 10 Gb/s twelve lane

*CX4 available in 5 Gb/s only.



Tyco Electronics' PARALIGHT active optical cable assemblies use state-of-the-art technology to provide cost effective high data throughput interconnects. The cables incorporate E/O and O/E conversion built into the connector shell to yield a dramatic improvement in PCB real estate utilization.

Using 850 nm VCSEL technology, the 5 Gb/s active cable assemblies will operate over a data rate of 2.5 to 5 Gb/s per lane with an aggregate data rate of 20 Gb/s in each direction. The 10 Gb/s active cable assemblies will operate over a data rate of 2.5 to 10 Gb/s per lane with an aggregate data rate of 40 Gb/s in each direction.

They are available in lengths up to 100 meters using 50 micron fiber. Longer lengths available upon request. The EOE circuitry is designed for use with 8B/10B encoded data streams, such as InfiniBand, Fibre Channel, and XAUI.

QSFP connector style supports connections for an I²C serial interface, which can be used to identify the product and performance capabilities.

Applications

- High Performance Computing Clusters
- Supercomputers
- High End Servers
- Mass Storage
- Metro Network Switch/Cross Connect
- High End Carrier Class Routers
- SDR, QDR and DDR InfiniBand Applications
- Other 2.5–10.0 Gb/s Applications (e.g. 10 Gb Fibre Channel or 10 Gig Ethernet XAUI on ports providing InfiniBand pinout 3.3 V power)

Mechanical/Environmental

- Up to 100 meters — longer lengths available upon request
- 25 mm bend radius
- Operating Case Temperature 0° C to 70° C
- Storage Temperature -40° C to 85° C

Materials

- OFNR/CSA-FT-6 (plenum) cable
- OFN-LS (LSZH rated) cable

Technical Document Product Specification 108-2330

Fibre Channel is a trademark of the Fibre Channel Industry Association.
INFINIBAND is a trademark of the InfiniBand Trade Association.
XAUI is a trademark of the 10Gigabit Ethernet Alliance XAUI Interoperability Group.

PARALIGHT Active Optical Cable Assemblies (Continued)

**Product Dimensions
IB 4X to QSFP/QSFP+**

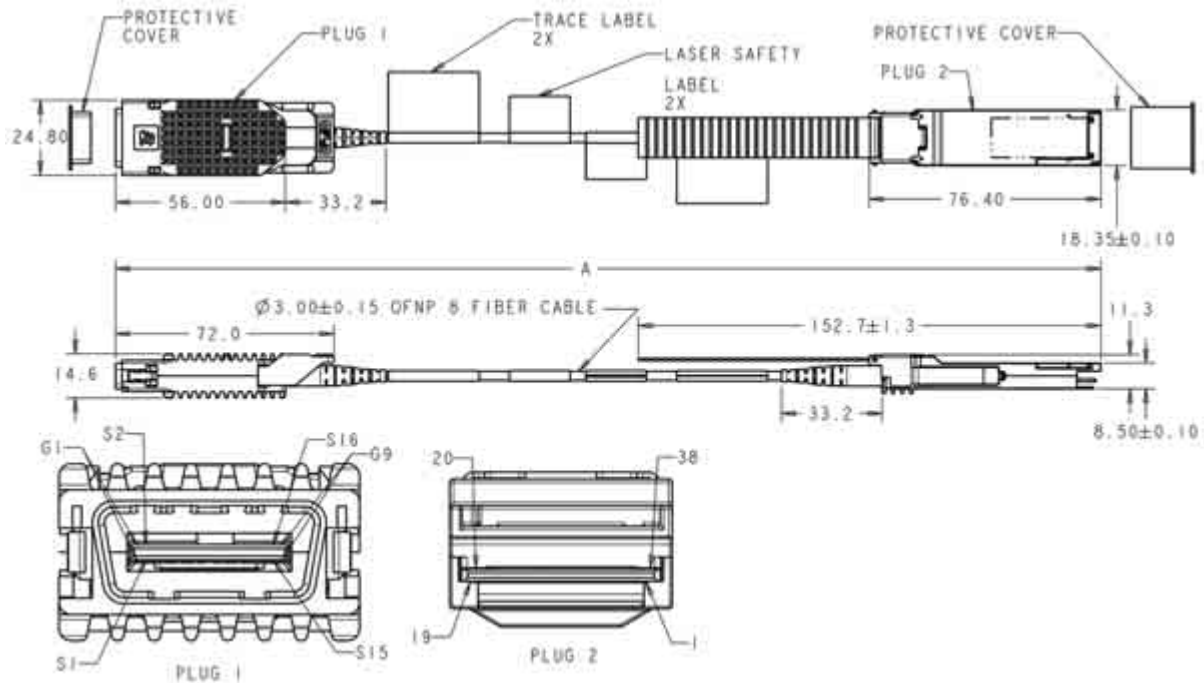

Front Panel Door Clearance

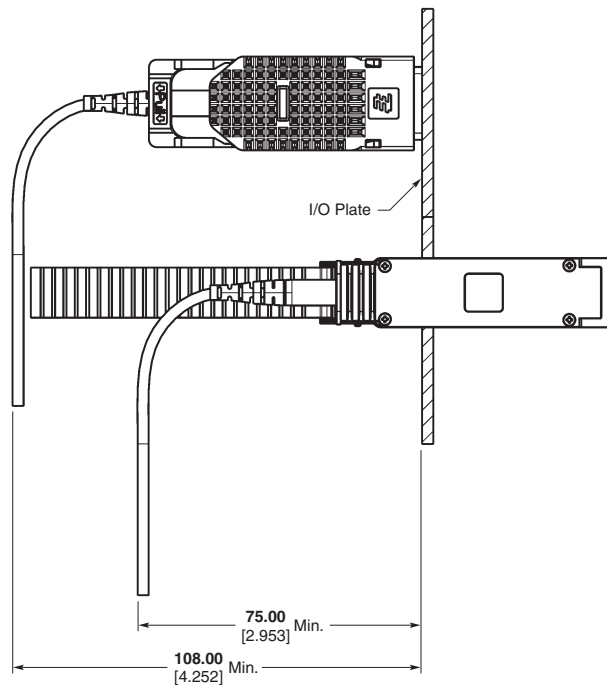

**Typical 5 Gb/s Eye Diagram
(PRBS2⁷-1 with crosstalk)**

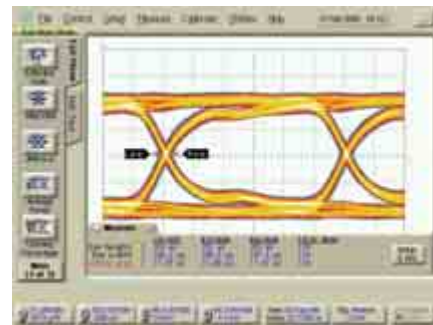

**Typical 10 Gb/s Eye Diagram
(PRBS2⁷-1 with crosstalk)**

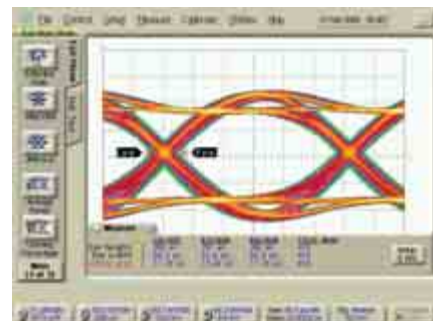

PARALIGHT Active Optical Cable Assemblies (Continued)

5 Gb/s Part Numbers

Length (meters)	Cable Type	5 GB/S CX4*** Part Numbers	5 GB/S CX4 to QSFP Part Numbers	5 GB/S QSFP Part Numbers	10 GB/S QSFP+ Part Numbers
2	OFNP**	2064782-1	2064781-1	2064778-1	2064779-1
	LSZH*	2064815-1	2064814-1	2064812-1	2064813-1
3	OFNP**	2064782-2	2064781-2	2064778-2	2064779-2
	LSZH*	2064815-2	2064814-2	2064812-2	2064813-2
5	OFNP**	2064782-3	2064781-3	2064778-3	2064779-3
	LSZH*	2064815-3	2064814-3	2064812-3	2064813-3
10	OFNP**	2064782-4	2064781-4	2064778-4	2064779-4
	LSZH*	2064815-4	2064814-4	2064812-4	2064813-4
15	OFNP**	2064782-5	2064781-5	2064778-5	2064779-5
	LSZH*	2064815-5	2064814-5	2064812-5	2064813-5
20	OFNP**	2064782-6	2064781-6	2064778-6	2064779-6
	LSZH*	2064815-6	2064814-6	2064812-6	2064813-6
25	OFNP**	2064782-7	2064781-7	2064778-7	2064779-7
	LSZH*	2064815-7	2064814-7	2064812-7	2064813-7
30	OFNP**	2064782-8	2064781-8	2064778-8	2064779-8
	LSZH*	2064815-8	2064814-8	2064812-8	2064813-8
40	OFNP**	2064782-9	2064781-9	2064778-9	2064779-9
	LSZH*	2064815-9	2064814-9	2064812-9	2064813-9
50	OFNP**	1-2064782-0	1-2064781-0	1-2064778-0	1-2064779-0
	LSZH*	1-2064815-0	1-2064814-0	1-2064812-0	1-2064813-0
100	OFNP**	1-2064782-1	1-2064781-1	1-2064778-1	1-2064779-1
	LSZH*	1-2064815-1	1-2064814-1	1-2064812-1	1-2064813-1

*LSZH = Low Smoke Zero Halogen
 **OFNP = Optical Fiber Nonconductive Plenum
 ***Also known as CX4 and SFF-8470
Note: Longer lengths available upon request.

5 GB/S General Specifications

Symbol	Parameter	Min.	Typical	Max.	Unit	Notes
	Data Rate/Channel	2.5	—	5	Gb/s	1
Tc	Operating Case Temperature	0	—	70	°C	2
Vcc	Supply Voltage	3.13	3.3	3.47	V	
	Total Power Dissipation	—	1.3	1.5	W	3
	Fiber Core Diameter	—	50	—	µm	

1. Test pattern PRBS 2E7-1
 2. Per End
 3. Central office environment per GR-468-CORE

5 GB/S Transmitter Electrical Specifications

Symbol	Parameter	Min.	Typical	Max.	Unit	Notes
	Input Common Mode	0	—	Vcc	V	1
V_diff_IN	Differential data swing	650	—	1600	mVpp	
Rin	Differential Input Impedance	80	100	120	Ω	

1. Internally AC coupled.

5 GB/S Receiver Electrical Specifications

Symbol	Parameter	Min.	Typical	Max.	Unit	Notes
	Output Common Mode	—	—	—	V	1
V_diff_OUT	Differential data swing	200	300	1200	mVpp	
Rout	Differential Output Impedance	—	100	—	Ω	
TJ	Total Jitter (p-p)	—	—	.42	UI	2
ΔT ch-ch	Skew	—	—	200	ps	

1. Internally AC Coupled.
 2. Total jitter is specified at a BER of 10⁻¹² using PRBS 2⁷-1.

Note: All part numbers are RoHS compliant.



PARALIGHT Active Optical Cable Assemblies (Continued)

10 GB/S
General Specifications

Symbol	Parameter	Min.	Typical	Max.	Unit	Notes
	Data Rate/Channel	2.5	—	10.0	Gb/s	1
Tc	Operating Case Temperature	0	—	70	°C	2
Vcc	Supply Voltage	3.13	3.3	3.47	V	
	Total Power Dissipation	—	1.5	1.7	W	3
	Fiber Core Diameter	—	50	—	µm	

1. Test pattern PRBS 2E7-1
2. Per End
3. Central office environment per GR-468-CORE

10 GB/S Transmitter
Electrical Specifications

Symbol	Parameter	Min.	Typical	Max.	Unit	Notes
	Input Common Mode	0	—	Vcc	V	1
V_diff_IN	Differential data swing	500	—	1600	mVpp	
Rin	Differential Input Impedance	80	100	120	Ω	

1. Internally AC coupled.

10 GB/S Receiver Electrical
Specifications

Symbol	Parameter	Min.	Typical	Max.	Unit	Notes
	Output Common Mode	—	—	—	V	1
V_diff_OUT	Differential data swing	200	300	1200	mVpp	
Rout	Differential Output Impedance	—	100	—	Ω	
TJ	Total Jitter (p-p)	—	—	.42	UI	2
ΔT ch-ch	Skew	—	—	200	ps	

1. Internally AC Coupled.
2. Total jitter is specified at a BER of 10⁻¹² using PRBS 2⁷-1.

Mechanical

Symbol	Parameter	Value	Unit	Notes
	Off Axis Load	22.2	N	
	Retention Load	89	N	
	Durability	250	cycles	

Regulatory Information

Symbol	Parameter	Compliance
	Preliminary Eye Safety Classification ¹	1M
	Electrostatic Discharge (ESD), human body	JESD22-A114D, Class 1 (1000 volts), human body model

Optical energy contained within cable.
CAUTION: Do not cut optical cable. Viewing the cut fiber ends, especially with certain optical instruments (for example, eye loupes, magnifiers, and microscopes) may pose an eye hazard.

This product is classified as a Class 1M Laser product in accordance with IEC 60825-1:1993+A1+A2 and complies with 21CFR 1040.10 and 1040.11 except for deviations pursuant to laser notice NO. 50, dated 24-Jun-2007.

Note: The TUV Bauartmark does not apply to LSZH assemblies

**INVISIBLE LASER RADIATION
DO NOT VIEW DIRECTLY WITH
OPTICAL INSTRUMENTS “(MAGNIFIERS)”
CLASS 1M LASER PRODUCT
840-850nm, 700uW**



10 Gigabit Fiber Optic Products Overview

MTP/MPO Round Cable Assemblies



QSFP Compatible MPO to MPO

Fiber Type	Fiber Count	Length in meters	Part Number
10 Gig / OM3 (50/125)	8	1	1938323-1
		5	1938323-5
		10	1-1938323-0
		20	2-1938323-0
		50	5-1938323-0

12-Fiber Reversed Fiber Path MPO to MPO

Fiber Type	Fiber Count	Length in meters	Part Number
10 Gig / OM3 (50/125)	12	1	1938324-1
		5	1938324-5
		10	1-1938324-0
		20	2-1938324-0
		50	5-1938324-0

For custom configurations, contact your Tyco Electronics sales representative.

LC Cable Assemblies



Simplex / Duplex	Cable Type	Side A	Side B	Jacket Type	Part Number	Part Numbers/Lengths (m)					
						1	2	3	5	10	15
LC Cable Assemblies											
Duplex	50/125 OM3	LC	LC	2 mm jacketed riser	X-2064862-X	2064862-1	2064862-2	2064862-3	2064862-5	1-2064862-0	1-2064862-5
	10Gig Fiber	LC	SC	2 mm jacketed riser	X-2064863-X	2064863-1	2064863-2	2064863-3	2064863-5	1-2064863-0	1-2064863-5
SC Cable Assemblies											
Simplex	50/125 OM3 10Gig Fiber	SC	SC	2 mm jacketed riser	X-2064883-X	2064883-1	2064883-2	2064883-3	2064883-5	1-2064883-0	1-2064883-5
Duplex	50/125 OM3 10Gig Fiber	SC	SC	2 mm jacketed riser	X-2064886-X	2064886-1	2064886-2	2064886-3	2064886-5	1-2064886-0	1-2064886-5
	50/125 OM3 10Gig Fiber	SC	ST	2 mm jacketed riser	X-2064889-X	2064889-1	2064889-2	2064889-3	2064889-5	1-2064889-0	1-2064889-5
ST Cable Assemblies											
Simplex	50/125 OM3 10Gig Fiber	ST	ST	2 mm jacketed riser	X-2064877-X	2064877-1	2064877-2	2064877-3	2064877-5	1-2064877-0	1-2064877-5
Duplex	50/125 OM3 10Gig Fiber	ST	ST	2 mm jacketed riser	X-2064880-X	2064880-1	2064880-2	2064880-3	2064880-5	1-2064880-0	1-2064880-5
MT-RJ SECURE Cable Assemblies											
Duplex	50/125 OM3 10Gig Fiber	MT-RJ	MT-RJ	1.8 mm jacketed riser	X-6588572-X	6588572-1	6588572-2	6588572-3	6588572-5	1-6588572-0	1-6588572-5
	50/125 OM3 10Gig Fiber	MT-RJ	SC	1.8 mm jacketed riser	X-6588573-X	6588573-1	6588573-2	6588573-3	6588573-5	1-6588573-0	1-6588573-5

Additional lengths available. See Tyco Electronics specification 1206850 for more details

Note: All part numbers are RoHS compliant.



LC and SC Connector Kits



LC Connector Kits — Standard Kits

Description	Fiber Type	Housing Color	Boot Color	Used with	Assembly Pack Part Number
				900 µm Buffered	2064938-1
Simplex	Multimode	Beige	Beige	1.6-2.0 mm Jacketed	2064938-2
				3.0 mm Jacketed	2064938-3
Duplex	Multimode	Beige	Beige	900 µm Buffered	2-2064938-1
				1.6-2.0 mm Jacketed	2-2064938-2
				3.0 mm Jacketed	2-2064938-3



SC Connector Kits — Standard Kits

Description	Fiber Type	Housing Color	Boot Color	Used with	Assembly Pack Part Number
				900 µm Buffered	2064939-1
Simplex	Multimode	Beige	Beige	2.0 mm Jacketed	2064939-2
				3.0 mm Jacketed	2064939-3
Duplex	Multimode	Beige	Beige	2.0 mm Jacketed	5504928-1
				3.0 mm Jacketed	5504657-1

LC and SC Adapters



LC Duplex Adapter for SC Cutout — Plastic

Alignment Sleeve Material	Description	Housing Color	Part Numbers
Ceramic	Flanged	Aqua	1-6457567-6
	Flangeless	Aqua	1-6457567-4
Metal	Flanged	Aqua	2-6457567-0
	Flangeless	Aqua	1-6457567-8

Shuttered LC Duplex Adapter for SC Cutout — Plastic

Alignment Sleeve Material	Description	Housing Color	Shutter Label Color	Part Number
Ceramic	Flanged	Aqua	Aqua	1-2064658-6
	Flangeless	Aqua	Aqua	1-2064752-4

LC Quad Adapter for SC Duplex Cutout — Plastic

Alignment Sleeve Material	Description	Housing Color	Part Numbers
Ceramic	Flanged	Aqua	1-1695790-0
	Flangeless	Aqua	1-1695790-1
Metal	Flanged	Aqua	1695790-9

SC Simplex Adapter — Plastic

Alignment Sleeve Material	Description	Housing Color	Part Numbers
Ceramic	Flanged	Aqua	2-5502632-4
	Flangeless	Aqua	5504632-6
Metal	Flanged	Aqua	2-5502632-3



SC Duplex Adapter — Plastic

Alignment Sleeve Material	Description	Housing Color	Part Numbers
Ceramic	Flanged	Aqua	2-5502776-6
Metal	Flanged	Aqua	2-5502776-5

Note: All part numbers are RoHS compliant.

MPO Cable Assemblies

MTP/MPO Round Cable Assemblies

Suitable for Interface to Transceiver

Product Facts

- Flexible round outer jacket for easier installation/routing
- Available in fiber counts up to 24
- Fiber path reversed or straight

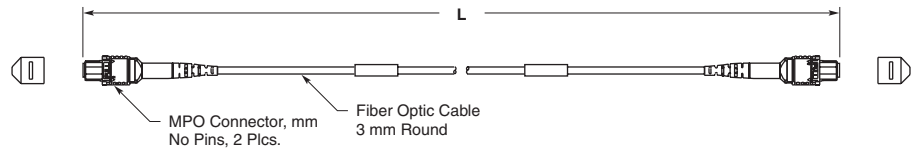

Applications

- Transceiver interface
- High density interconnect for optical switches, routers, PC cards

Options

- Fiber Types
 - Singlemode
 - Low Loss Singlemode
 - 50/125 μm OM4
 - 50/125 μm OM3
 - 50/125 μm OM2
 - 62.5/125 μm
 - Bend insensitive fiber G657A or G657B
- Cable Ratings
 - Riser rated, UL-OFNR
 - Plenum rated, UL-OFNP
 - Low Smoke, Zero Halogen rated, LSZH

QSFP Compatible MPO to MPO

Fiber Type	Fiber Count	Length in meters	Part Number
10 Gig / OM3 (50/125)	8	1	1938323-1
		5	1938323-5
		10	1-1938323-0
		20	2-1938323-0
		50	5-1938323-0
OM2 50/125	8	1	1938208-1
		5	1938208-5
		10	1-1938208-0
		20	2-1938208-0
		50	5-1938208-0

Reverse Fiber Path

MPO Left Fiber #		MPO Right Fiber #
1	↔	12
2	↔	11
3	↔	10
4	↔	9
5	Not Connected	8
6	Not Connected	7
7	Not Connected	6
8	Not Connected	5
9	↔	4
10	↔	3
11	↔	2
12	↔	1

12-Fiber Reversed Fiber Path MPO to MPO

Fiber Type	Fiber Count	Length in meters	Part Number
10 Gig / OM3 (50/125)	12	1	1938324-1
		5	1938324-5
		10	1-1938324-0
		20	2-1938324-0
OM2 50/125	12	1	1938209-1
		5	1938209-5
		10	1-1938209-0
		20	2-1938209-0
50	5-1938209-0		

Reverse Fiber Path

MPO Left Fiber #		MPO Right Fiber #
1	↔	12
2	↔	11
3	↔	10
4	↔	9
5	↔	8
6	↔	7
7	↔	6
8	↔	5
9	↔	4
10	↔	3
11	↔	2
12	↔	1

For custom configurations, contact your Tyco Electronics sales representative.

Note: All part numbers are RoHS compliant.



MPO Cable Assemblies (Continued)

MTP/MPO Breakout Cable Assemblies

Suitable for
Telecommunication and
Data Communication
Equipment

Options include:

- Ribbon or Round Cable
- Fiber counts up to 24
- Fiber Types
 - Singlemode
 - Low Loss Singlemode
 - 50/125 μm OM3
 - 50/125 μm OM2
 - 62.5/125 μm
 - Bend insensitive fiber G657A or G657B
- Cable Ratings
 - Riser rated, UL-OFNR
 - Plenum rated, UL-OFNP
 - Low Smoke, Zero Halogen rated, LSZH
- Connector Types
 - LC
 - SC
 - ST
 - FC
 - MU
 - MT-RJ SECURE Connector
- Different configurations available upon request

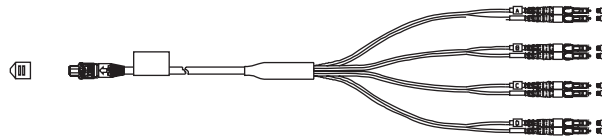

MPO to LC Duplex
8 Fiber Straight Through on Ribbon Fiber

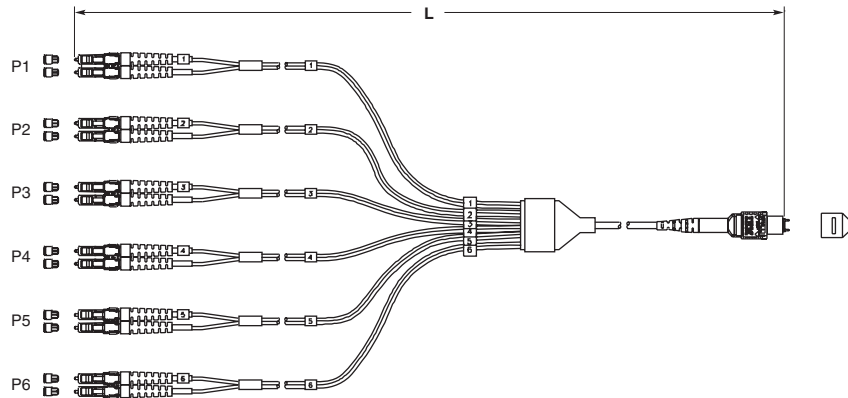

MPO to LC Duplex
12 Fiber Straight Through on Round Cable

MPO Connectors and Adapters

Product Facts

- Tested to Telecordia GR-1435
- Push Pull Latching
- 4, 8, 12, OR 24 fibers
- Color-coded housings differentiate singlemode and multimode:
 - Multimode — Beige
 - Singlemode — Green
- Manufactured to IEC Standards 61754-7 and TIA/EIA 604-5

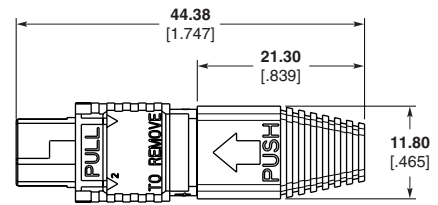

Industry Standard

Performance Characteristics

Singlemode

Insertion Loss (Typ.) — 0.25 dB
 Insertion Loss (Max.) — 0.75 dB
 Return Loss — > 55 dB

Multimode

Insertion Loss (Typ.) — 0.2 dB
 Insertion Loss (Max.) — 0.5 dB
 Return Loss — > 20 dB



MPO Connector Kit Selection — Plug Kits

Fiber Type	Female (no pins)	Male (with pins)
Singlemode	6457981-1	6457981-2
Multimode	6457983-1	6457983-2

Note: Ferrules and Mini-Boots are sold separately. See chart below for proper part numbers.

MPO Ferrule Kit with Mini-Boot

Fiber Type	4 Position	8 Position	12 Position
Singlemode	5492221-1	5492221-2	5492221-3
Multimode	5503839-1	5503839-2	5503839-3

Crimping Tool with Dieset

1588698-1



MPO Simplex Adapters

Adapter Type	Part Number
Adapter w/flange	1588172-1
Adapter w/flange and clip	1588172-2
Adapter w/o flange	1588172-3
Adapter w/o flange and w/clip	1588172-4



MPO Quad 30°

Adapter Type	Part Number
Adapter	2064792-1

Note: All part numbers are RoHS compliant.

PARA-OPTIX High Density Cable Assemblies

Product Facts

- Uses the latest generation MT-style ferrules
- Available in up to 72 fibers through a single MPO style connector
- Available in 24, 48, and 72 fiber
- Other fiber counts and lengths available
- Reduced space requirements
- Can provide cost benefit on a per-fiber basis



Potential Applications

- Jumpers and trunk cables for Data Centers
- Optical backplanes
- SAN Very Short Reach applications

Please contact your local Sales Representative or Tyco Electronics for detailed performance characteristics and specifications.

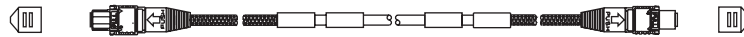

Part Number	Description
6588967-X	24-fiber MPO-MPO, 50/125 Multimode
6693069-X	48-fiber MPO-MPO, 50-125 Multimode
1919166-X	72-fiber MPO-MPO, 50/125 Multimode

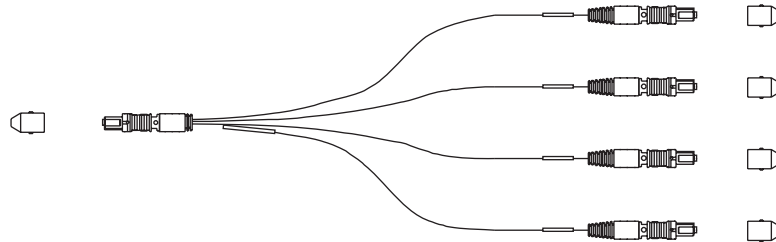

Part Number	Description
6693068-X	48-fiber MPO — (4), 12-fiber MPO, 50/125 bare ribbon

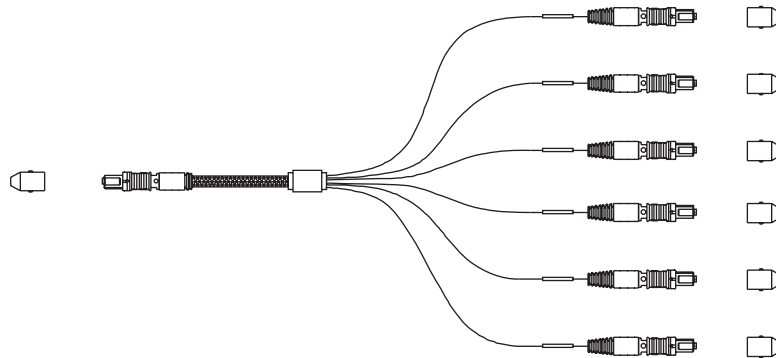

Part Number	Description
6693067-X	72-fiber MPO — (6), 12-fiber MPO, 50/125 bare ribbon

Note: All part numbers are RoHS compliant.

Note: "X" above denotes length. Check latest version of Tyco Electronics' customer drawing or contact your local sales representative for specific lengths available.

LIGHTRAY MPX Backplane Solutions

Product Facts

- LIGHTRAY MPX Interconnects offer a blindmate backplane solution
- A complete fiber optic system which is ideal for applications requiring customized solutions
- Features very small, high density LIGHTRAY MPX connectors
- Based on industry proven MT interconnection technology
- Can use both multimode (62.5/125 μm or 50/125 μm) and singlemode (9 μm) fiber, and is designed to meet Bellcore GR 1435
- Saves valuable board space on the PCB, backplane and I/O
- Suitable for blind mate (free floating) and bulkhead applications. Offers flexible fiber routing and management
- 2.5 mm of daughter card axial travel is provided
- Misalignment pick-up tolerance are:
 ± 2.0 mm horizontal
 ± 2.5 mm vertical
 ± 2 degree angular

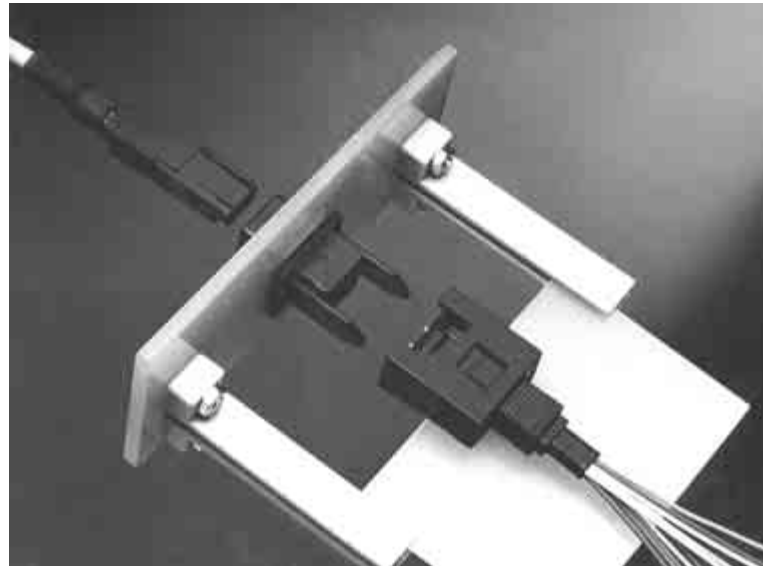

Tyco Electronics' LIGHTRAY MPX Interconnection System is designed for blind mate backplane and bulkhead dense fiber-to-fiber interconnect applications, including stand alone interconnections when used with bulkhead adapters. The LIGHTRAY MPX Interconnection System

offers maximum flexibility, making them ideal for customized requirements and solutions.

Based on the field-proven MT ferrule technology, the LIGHTRAY MPX Interconnection System features a miniature multi-fiber connector, which holds up to 24 fibers on 250 μm centers.

Tyco Electronics' LIGHTRAY MPX Interconnection System is multi-sourced and features fanout assemblies, mini trunk and trunk cable assemblies, pre-loaded enclosures, cable management systems, PC card connector housings and tooling, bulkhead adapters and transceiver modules and datalinks.

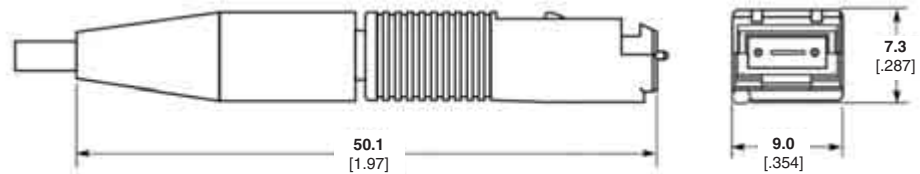

LIGHTRAY MPX Connector



Design Objectives

Parameter	Value		
	Multimode	Singlemode	Singlemode Low Loss
Insertion Loss, Mean (typical)	0.20 dB	0.25 dB	0.20 dB
Insertion Loss, Max.	0.50 dB	0.75 dB	0.30 dB / 0.5 dB*
Return Loss, Min.	20 dB	45 dB	45 dB
Durability,	0.3 dB CIT — 200 cycles		
Straight Pull 2.2N	0.3 dB change		
Vibration, 10 to 55 Hz	0.3 dB change		
Temperature, Storage	-40° C to +85° C		
Temperature Operating	-40° C to +85° C		
Thermal Aging, 14 Days @ +85° C	0.3 dB change		
Humidity, 14 days 95% Rh @ +60° C	0.3 dB change		

* Low loss tested in-house to a maximum of 0.3 dB against a reference. 0.5 dB is maximum random mate loss.



LIGHTRAY MPX Backplane Solutions (Continued)

Bulkhead Coupling Adapter

Part Number 492305-1

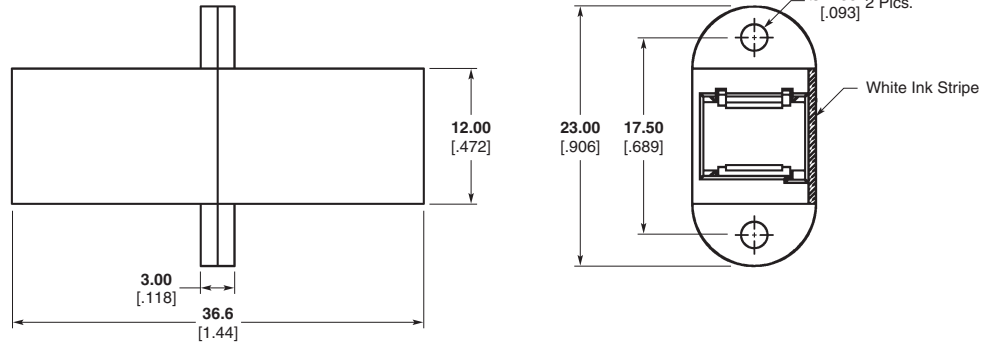

Backplane Housings and Adapters

Backplane Housing — Simplex

Part Number 492739-1

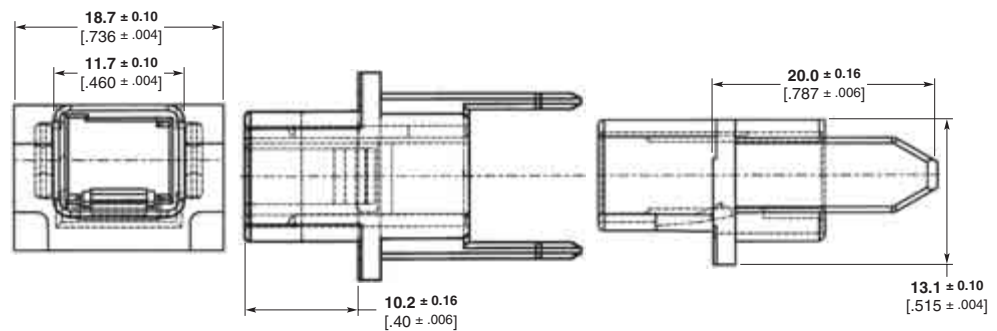

System Card Housing — Simplex

Part Number 492234-1

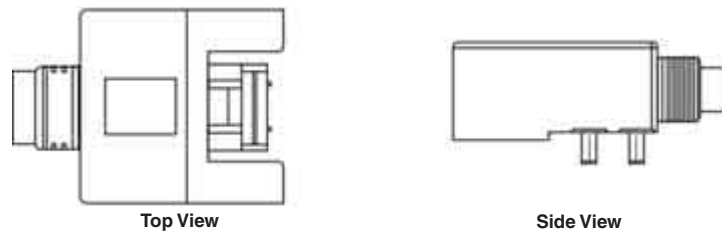

Product Facts

- Holds one standard or low loss LIGHTRAY MPX connector
- Simple press-fit mounting — no hardware needed
- Unique latching provides positive retention when card is unmated

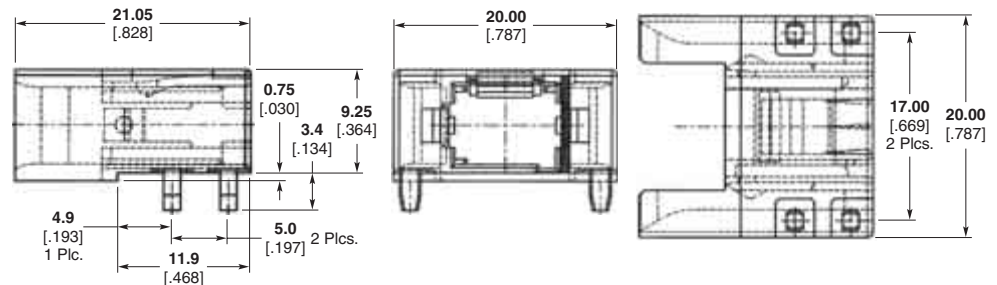

Note: All part numbers are RoHS compliant.

LIGHTRAY MPX Backplane Solutions (Continued)

Backplane Housings and Adapters (Continued)

Backplane Housing — Duplex



Part Number 1374490-1 and 6374493-1 (with safety shutter)

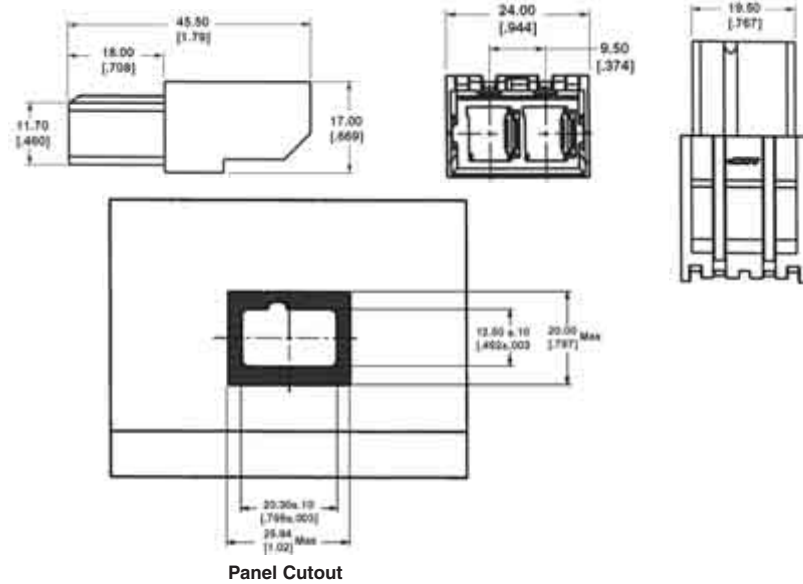

Product Facts

- Holds two standard or low loss LIGHTRAY MPX connectors
- Optional self actuated laser safety shutter
- Up to 48 fibers simultaneously mated and managed
- Mates to part number 1374491-1
- Used with clip part number 1278530-2

System Card Housing — Duplex



Part Number 1374491-1

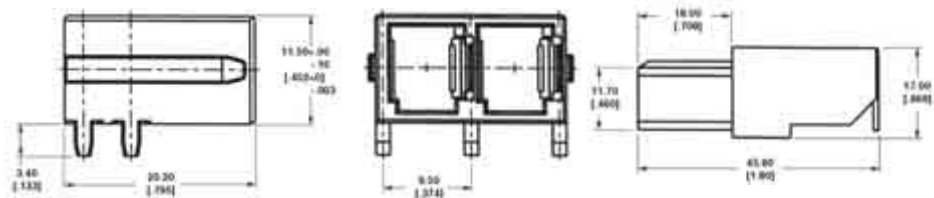

Product Facts

- Holds two standard or low loss LIGHTRAY MPX connectors
- Up to 48 fibers simultaneously mated and managed

Note: All part numbers are RoHS compliant.



LIGHTRAY MPX Backplane Solutions (Continued)

Backplane Housings and Adapters (Continued)

Backplane Housing — Quad



Part Number 6278529-1

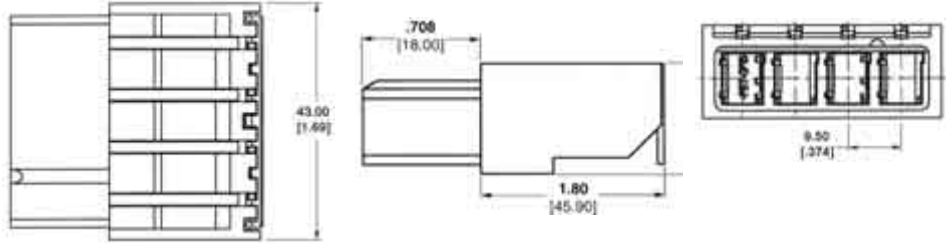

Product Facts

- Holds up to 4 standard or low loss LIGHTRAY MPX connectors
- Self actuated laser-safe shutter
- Up to 96 fibers simultaneously mated and managed

System Card Housing — Quad

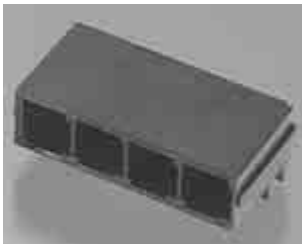

Part Number 1278391-1

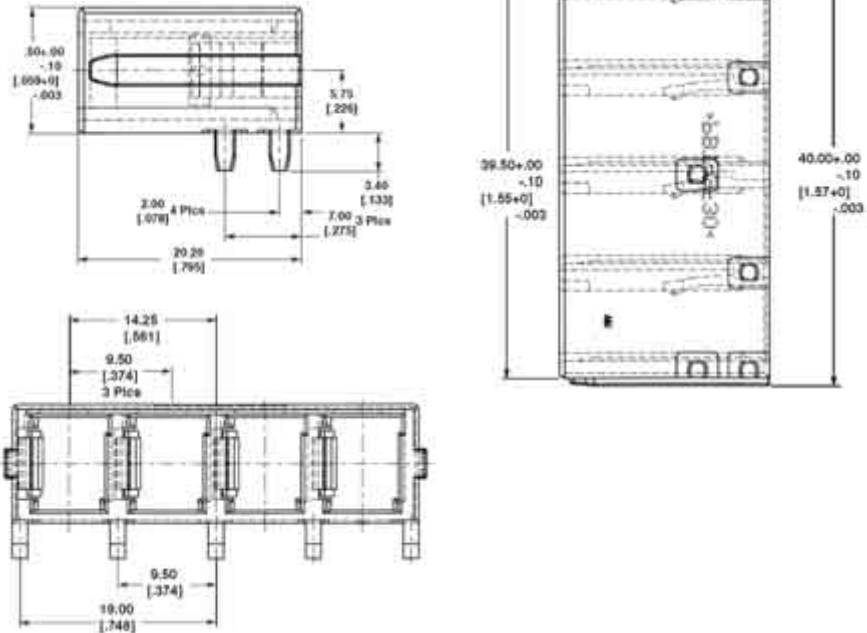

Product Facts

- Holds 4 standard or low loss LIGHTRAY MPX connectors
- Up to 96 fibers simultaneously mated and managed

Note: All part numbers are RoHS compliant.

LIGHTRAY MPX Backplane Solutions (Continued)

Fanout Assemblies

Product Facts

- Multimode 62.5/125 μm and 50/125 μm
- Singlemode 9 μm , 8° angle interface
- Color coded buffered fiber or LSZH (Low Smoke Zero Halogen) sheathed cable with breakout kit
- Male LIGHTRAY MPX connectors (with guide pins)
- 4, 8, 12, 16 and 24 fibers
- Custom lengths available
- Connector labeling to guide insertion
- LC, SC, ST, FC or MT-RJ terminations available

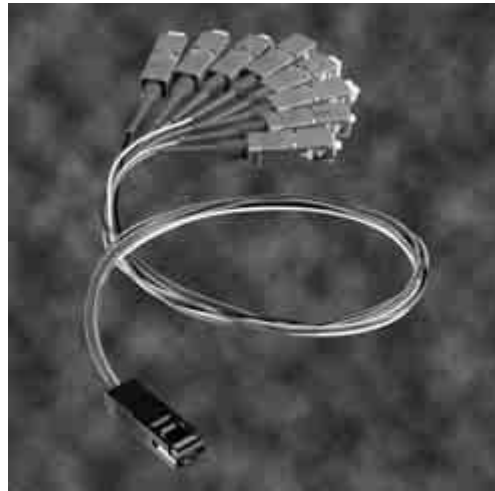

Mini Trunk Assemblies

Product Facts

- Multimode 62.5/125 μm and 50/125 μm
- Singlemode 9 μm , 8° angle interface
- 250 μm bare ribbon and LSZH (Low Smoke Zero Halogen) sheathed ribbon cable available
- Female LIGHTRAY MPX connectors (without guide pins)
- 4, 8, 12, 16 and 24 fibers
- Custom lengths available
- Connector labeling to guide insertion



Trunk Assemblies

Product Facts

- Multimode 62.5/125 μm and 50/125 μm
- Singlemode 9 μm , 8° angle interface
- Available with female LIGHTRAY MPX connectors (without guide pins) and/or male LIGHTRAY MPX connectors (with guide pins)
- LC, SC, ST, FC or MT-RJ terminations available for hybrid configurations
- 4, 8 and 12 position ribbon fiber sub-units
- LSZH (Low Smoke Zero Halogen) sheathed cable (round construction)
- Internal/external cable
- Custom lengths available





LIGHTRAY MPX Backplane Solutions (Continued)



Singlemode — Standard Loss LIGHTRAY MPX Pigtails

Singlemode — Standard Loss LIGHTRAY MPX Pigtails
Maximum Insertion Loss 1.0dB (1310nm)

Description	Part Number
4-fiber LIGHTRAY MPX (m) pigtail assy., 900 μm buffered fibers	6457078-x
8-fiber LIGHTRAY MPX (m) pigtail assy., bare ribbon	6374392-x
8-fiber LIGHTRAY MPX (f) pigtail assy., bare ribbon	6374539-x
8-fiber LIGHTRAY MPX (m) pigtail assy., 900 μm buffered fibers	6374538-x
8-fiber LIGHTRAY MPX (f) pigtail assy., 900 μm buffered fibers	6374537-x

Singlemode — Low Loss LIGHTRAY MPX Pigtails

Singlemode — Low Loss LIGHTRAY MPX Pigtails
Maximum Insertion Loss 0.5dB (1310nm) Random Mate

Description	Part Number
8-fiber LIGHTRAY MPX (m) pigtail assy., bare ribbon	6374448-x
8-fiber LIGHTRAY MPX (f) pigtail assy., bare ribbon	6374639-x
8-fiber LIGHTRAY MPX (m) pigtail assy., 900 μm buffered fibers	6457173-x
8-fiber LIGHTRAY MPX (f) pigtail assy., 900 μm buffered fibers	6457174-x

Note: All assemblies are customer built to customer's length specifications. Dash number indicated length. Please contact Tyco Electronics for proper dash number.



Singlemode — Standard Loss LIGHTRAY MPX to MPX Cable Assemblies Bare Ribbon

Singlemode — Standard Loss LIGHTRAY MPX to MPX Cable Assemblies Bare Ribbon
Maximum Insertion Loss 1.0dB (1310nm)

Description	Part Number
8-fiber LIGHTRAY MPX (m) to LIGHTRAY MPX (m) assy., bare ribbon	6457394-x
8-fiber LIGHTRAY MPX (f) to LIGHTRAY MPX (f) assy., bare ribbon	6374600-x
12-fiber LIGHTRAY MPX (m) to LIGHTRAY MPX (m) assy., bare ribbon	6374743-x

Singlemode — Low Loss LIGHTRAY MPX to MPX Cable Assemblies

Singlemode — Low Loss LIGHTRAY MPX to MPX Cable Assemblies
Maximum Insertion Loss 0.5dB (1310nm) Random Mate

Description	Part Number
4-fiber LIGHTRAY MPX (m) to LIGHTRAY MPX (m) assy., bare ribbon	6457398-x
8-fiber LIGHTRAY MPX (m) to LIGHTRAY MPX (m) assy., bare ribbon	6374738-x

Note: All assemblies are customer built to customer's length specifications. Dash number indicated length. Please contact Tyco Electronics for proper dash number.

Note: All part numbers are RoHS compliant.

LIGHTRAY MPX Backplane Solutions (Continued)



Singlemode — Standard Loss LIGHTRAY MPX to MPX Cable Assemblies Jacketed

Singlemode — Standard Loss LIGHTRAY MPX to MPX Cable Assemblies Jacketed
Maximum Insertion Loss 1.0dB (1310nm)

Description	Part Number
8-fiber LIGHTRAY MPX (f) to LIGHTRAY MPX (f) assy., jacketed ribbon	6374887-x

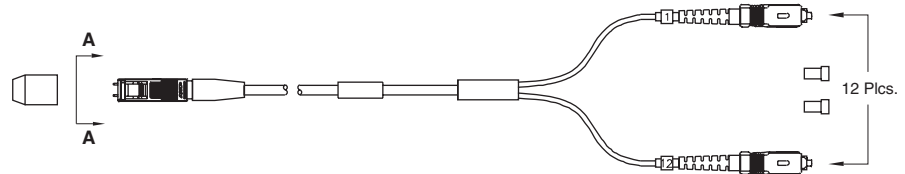

Singlemode — Standard Loss LIGHTRAY MPX to SC Cable Assemblies

Singlemode — Standard Loss LIGHTRAY MPX to SC Cable Assemblies
Maximum Insertion Loss 1.0dB (1310nm)

Description	Part Number
12-fiber LIGHTRAY MPX (m) assy. To (12) SC, ruggedized	5492515-x

Note: All part numbers are RoHS compliant.



LIGHTRAY MPX Backplane Solutions (Continued)

Dust Covers

Description		Part Number
Simplex		
System Card	Board Side	1278201-1
	Backplane Side	492578-1
Backplane	Inside Cage	492575-1 (no insert)
		5492576-1 (with insert)
	Back of Cage	503967-5 (removal tool)
Duplex		
System Card	Board Side	5502871-1
	Backplane Side	1374674-1
Backplane	Inside Cage	6374671-1
	Back of Rack	5502871-1
Quad		
System Card	Board Side	5502871-1
	Backplane Side	1374547-1
Backplane	Inside Cage	6374548-1
	Back of Rack	5502871-1
Bulkhead		5502871-1
Cable		492577-1 (without strap)
		492577-2 (with strap)

Cleaning Kit

Product Facts

- 2 re-useable cleaning kit assemblies
- 2 LIGHTRAY MPX bulkhead adapters
- 2 LIGHTRAY MPX backplane housings
- 1 pack of 24 cleaning tool inserts (can be ordered separately)



Description	Part Number
LIGHTRAY MPX Cleaning Kit	1278498-1
Cleaning Inserts (24/pack)	1457019-3

Connector Microscope Adapters

Product Facts

- Designed specifically for the LIGHTRAY MPX Connector
- Fits in standard Tyco Electronics' microscope Part Number 1754767-1
- 200 x power

Description	Part Number*
Microscope Adapter	1828834-1
Microscope Adapter (angled)	1828835-1

* Coupling adapter Part Number 1985041-1 required.

Note: All part numbers are RoHS compliant.

Cleaners

MTP/MPO IBC Cleaner
Part Number 1918809-1

Product Facts

- Cleans male or female MTP/MPO connectors
- Pre-washed cleaning cloth is lint and debris free
- Each cleaner is capable of more than 400 cleanings
- Can be used for bulkhead and unmated MTP/MPO cleaning
- Protective dust cover doubles as an adapter cap for cleaning unmated connectors
- FOCIS 5-Type MTP/MPO interface compliant
- Removes dust and oil contamination
- Ideal solution for cleaning parallel optics transceivers



The MTP/MPO IBC (In Bulkhead Cleaner) dry cloth cleaner offered by Tyco Electronics utilizes a densely woven micro-fiber cloth that cleans male (with pins) or female MTP/MPO connectors while in adapters, bulkheads, faceplates, or in unmated form with the unique adapter/dust cover. The unique cleaning cloth also reduces static charge

making it one of the most advanced cleaning systems available for bulkhead optical connector cleaning.

Applications

For effective cleaning of:

- Male and female MTP/MPO connectors inside mating adapters
- Unmated male and female MTP/MPO connectors using included adapter

- Parallel optics transceivers
- Networking gear including switches and routers
- Factory or field connectors

Product Dimensions

Length — 184.2 mm [7.25 in.]
Width — 56.5 mm [2.22 in.]
Thickness — 22 mm [0.866 in.]
Adapter Length — 19.5 mm [0.759 in.]

MTP is a trademark of US Conec Ltd.

OPTIPOP R Reel Cleaner

Product Facts

- Static attraction is minimized
- Ultra clean micro-fiber cloth captures debris and other contamination
- Robust cloth does not fray or leave fibrous material behind
- Reduces the number of field and test issues caused by contaminated end faces
- High-end cost effective cleaning solution



The OPTIPOP R dry cloth cassette cleaners offered by Tyco Electronics utilize a densely woven micro-fiber cloth that cleans fiber optic connector tips while reducing static charge. This makes them one of the most advanced cleaning systems available for optical connector cleaning.

Applications

A variety of reel cleaner configurations allow for use on the major optical connector types including FC, SC, ST, LC, MU, ODVA conforming, MT-RJ SECURE connectors, and MPO.

Product Dimensions

Length — 127 mm [5.00 in.]
Width — 83 mm [3.26 in.]
Thickness — 48 mm [1.89 in.]
Weight — 150 g [0.33 lb.]



Reel Cleaner Refill (Six per Pack)
Part Number 1918806-1







Description	Part Number
MPO w/pins reel cleaner	1918802-1
One slot reel cleaner; 1.25 mm, 2.5 mm, MT No Pins	1918803-1
Reel cleaner refill (six per pack)	1918806-1

OPTIPOP is a trademark of NTT Advanced Technology Corporation.

Note: All part numbers are RoHS compliant.

Simplex and Duplex Fiber Assemblies

LC Cable Assemblies

	Simplex / Duplex	Cable Type	Side A	Side B	Jacket Type	Part Number	Part Numbers/Lengths (m)						
							1	3	5	10			
	Simplex	Singlemode	LC	LC	900 micron	X-2064843-X	2064843-1	2064843-3	2064843-5	1-2064843-0			
					2 mm jacketed riser	X-2064844-X	2064844-1	2064844-3	2064844-5	1-2064844-0			
			LC	SC	900 micron	X-2064845-X	2064845-1	2064845-3	2064845-5	1-2064845-0			
					2 mm jacketed riser	X-2064846-X	2064846-1	2064846-3	2064846-5	1-2064846-0			
			LC	FC	2 mm jacketed riser	X-2064847-X	2064847-1	2064847-3	2064847-5	1-2064847-0			
			LC / APC	LC / APC	2 mm jacketed riser	X-2064869-X	2064869-1	2064869-3	2064869-5	1-2064869-0			
			LC / APC	SC / APC	2 mm jacketed riser	X-2064870-X	2064870-1	2064870-3	2064870-5	1-2064870-0			
			LC / APC	FC / APC	2 mm jacketed riser	X-2064871-X	2064871-1	2064871-3	2064871-5	1-2064871-0			
				50/125 Multimode	LC	LC	LC	2 mm jacketed riser	X-2064848-X	2064848-1	2064848-3	2064848-5	1-2064848-0
						LC	SC	2 mm jacketed riser	X-2064849-X	2064849-1	2064849-3	2064849-5	1-2064849-0
	62.5/125 Multimode	LC				LC	LC	900 micron	X-2064850-X	2064850-1	2064850-3	2064850-5	1-2064850-0
								2 mm jacketed riser	X-2064851-X	2064851-1	2064851-3	2064851-5	1-2064851-0
						LC	SC	2 mm jacketed riser	X-2064852-X	2064852-1	2064852-3	2064852-5	1-2064852-0
								2 mm jacketed riser	X-2064853-X	2064853-1	2064853-3	2064853-5	1-2064853-0
	Duplex	Singlemode	LC	LC	2 mm jacketed riser	X-2064853-X	2064853-1	2064853-3	2064853-5	1-2064853-0			
			LC	SC	2 mm jacketed riser	X-2064854-X	2064854-1	2064854-3	2064854-5	1-2064854-0			
			LC	ST	2 mm jacketed riser	X-2064856-X	2064856-1	2064856-3	2064856-5	1-2064856-0			
			LC	LC	2 mm jacketed riser	X-2064858-X	2064858-1	2064858-3	2064858-5	1-2064858-0			
				50/125 Multimode	LC	SC	2 mm jacketed riser	X-2064859-X	2064859-1	2064859-3	2064859-5	1-2064859-0	
						ST	2 mm jacketed riser	X-2064860-X	2064860-1	2064860-3	2064860-5	1-2064860-0	
						LC	MT-RJ	1.8 mm jacketed riser	X-2064861-X	2064861-1	2064861-3	2064861-5	1-2064861-0
							50/125 OM3 10Gig Fiber	LC	LC	LC	2 mm jacketed riser	X-2064862-X	2064862-1
			LC	SC	2 mm jacketed riser				X-2064863-X	2064863-1	2064863-3	2064863-5	1-2064863-0
			LC	LC	2 mm jacketed riser				X-2064865-X	2064865-1	2064865-3	2064865-5	1-2064865-0
	62.5/125 Multimode	LC	SC	2 mm jacketed riser	X-2064866-X				2064866-1	2064866-3	2064866-5	1-2064866-0	
			ST	2 mm jacketed riser	X-2064867-X				2064867-1	2064867-3	2064867-5	1-2064867-0	
LC	MT-RJ	1.8 mm jacketed riser	X-2064868-X	2064868-1	2064868-3				2064868-5	1-2064868-0			

Additional lengths available. See Tyco Electronics specification 1206850 for more details.



LC Loopback Cables

Simplex / Duplex	Cable Type	Side A	Side B	Jacket Type	Part Number
LC Loopback Cables	Singlemode	LC	N/A	N/A	2064872-1
	62.5/125 Multimode	LC	N/A	N/A	2064873-1
	50/125 Multimode	LC	N/A	N/A	2064874-1

SC Loopback Cables

Simplex / Duplex	Cable Type	Side A	Side B	Jacket Type	Part Number
SC Loopback Cables	Singlemode	SC	N/A	N/A	5504883-1
	62.5/125 Multimode	SC	N/A	N/A	5503141-2
	50/125 Multimode	SC	N/A	N/A	5503141-1

Note: All part numbers are RoHS compliant.

Engineering Notes



Table of Contents

Section 2 — Connectors, Adapters, Tooling & Accessories	29-60
LC Connectors	30-35
LC Connector Kits	30, 31
LC Connector Components.....	32, 33
LC Adapters	34, 35
SC Connectors	36-38
SC Connector Kits	36
SC Connector Components	37, 38
SC Adapters	39-41
SC to SC Adapters	39, 40
SC to ST Hybrid Adapters	40, 41
Slide-On Retractable Cover for SC Simplex or Duplex Applications	41
ST Connectors and Adapters	42-45
ST Connector Kits.....	42
ST Connector Components	43
ST Active Device Mounts	43
FC Connectors	44
FC Connector Kits	44
FC Adapters	44, 45
FC to FC Adapters.....	44
FC to ST Hybrid Adapters	45
FC to SC Hybrid Adapters.....	45
ESCON Connector.....	46
FSMA Connector	46
FSMA Adapter.....	46
MT-RJ SECURE Connectors	47
LIGHTCRIMP PLUS Connector	48
Tooling.....	49-56

ESCON is a trademark of IBM Corporation.

LC Connector Kits

LC Connector Kits — Standard Kits

Product Facts

- Singlemode Telcordia GR-326 Tested (Report 501-652)
- Multimode TIA/EIA 568B.3 tested
- Components packaged in 25 piece bags for easy access
- Same one-piece connector body for jumper and buffer
- Field installable duplex clip
- Compatible with anaerobic adhesives
- Mates with LC adapters (pages 34-35), LC Transceivers



Performance (typical)

Insertion Loss — 0.2dB
Reflectance — -55dB
Operating Temperature — -40° C to +75° C

Material

Ferrule — Zirconia
Housing — UL 94 V-0 rated thermoplastic

Length —

Ferrule Tip to End of Boot

900 µm Buffered — 31.5 mm
2.0 mm Jacketed — 52.0 mm
3.0 mm Jacketed — 51.0 mm

Description	Fiber Type	Housing Color	Boot Color	Used with	Assembly Pack Part Number
Simplex	Singlemode	Blue	Blue	900 µm Buffered	2064937-1
				1.6-2.0 mm Jacketed	2064937-2
				3.0 mm Jacketed	2064937-3
	Multimode	Beige	Beige	900 µm Buffered	2064938-1
				1.6-2.0 mm Jacketed	2064938-2
				3.0 mm Jacketed	2064938-3
Duplex	Singlemode	Blue	Blue	900 µm Buffered	2-2064937-1
				1.6-2.0 mm Jacketed	2-2064937-2
				3.0 mm Jacketed	2-2064937-3
	Multimode	Beige	Beige	900 µm Buffered	2-2064938-1
				1.6-2.0 mm Jacketed	2-2064938-2
				3.0 mm Jacketed	2-2064938-3

LC Connector Kits — Short Boot Kits

Product Facts

- Ferrule Tip to End of Boot Length: 42.5 mm
- 27.45 mm adapter to end of boot
- GR-326 small form factor requirements

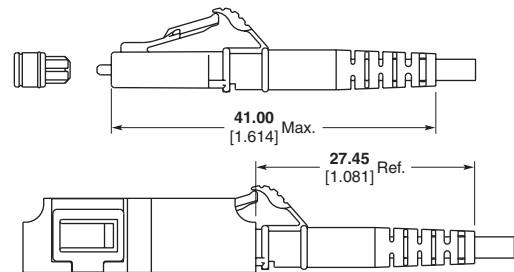

Description	Fiber Type	Housing Color	Boot Color	Used with	Installation Pack Part Number
Simplex	Singlemode	Blue	Blue	1.6-2.0 mm Jacketed	1918407-1
	Multimode	Beige	Beige	1.6-2.0 mm Jacketed	1918405-1
Duplex	Singlemode	Blue	Blue	1.6-2.0 mm Jacketed	1918406-1
	Multimode	Beige	Beige	1.6-2.0 mm Jacketed	1918404-1

Note: All part numbers are RoHS compliant.

LC Connector Kits (Continued)

LC Connector Kits — Tight Jacketed Kits

Product Facts

- Non pull-proof connector for use with tight jacketed fiber cable
- Allows jacket and buffer to move together to prevent micro-bends and fiber breakage
- LC Commercial Item Description (CID) interim approval by Naval Surface Warfare Center, Dahlgren Division
- Tested using MIL-PRF-85045/16 2.0 mm cable



Applications

- In flight networks
- Shipboard applications
- Aero market

Material

Ferrule — Zirconia
Housing — UL 94 V-0 rated thermoplastic

Length — Ferrule Tip to End of Boot: 52.0 mm

Engineering Report
502-1191

Description	Fiber Type	Housing Color	Boot Color	Used with	Individual Pack Part Number	Bulk Pack Part Number
Simplex	Singlemode	Blue	Blue	1.6-2.0 mm Jacketed	6828095-1	6828095-2
				2.4 mm Jacketed	1918228-1	1918228-2
	Multimode	Beige	Beige	1.6-2.0 mm Jacketed	6828094-1	6828094-2
				2.4 mm Jacketed	1918153-1	1918153-2
Duplex	Singlemode	Blue	Blue	1.6-2.0 mm Jacketed	6828130-1	6828130-2
	Multimode	Beige	Beige	1.6-2.0 mm Jacketed	6828129-1	6828129-2

LC Connector Kits — Ultra Short LC

Product Facts

- Ferrule tip to end of boot length 37.5 mm
- GR-326 small form factor requirements
- Ideal for cabinets with limited space
- Call for details about duplex connectors

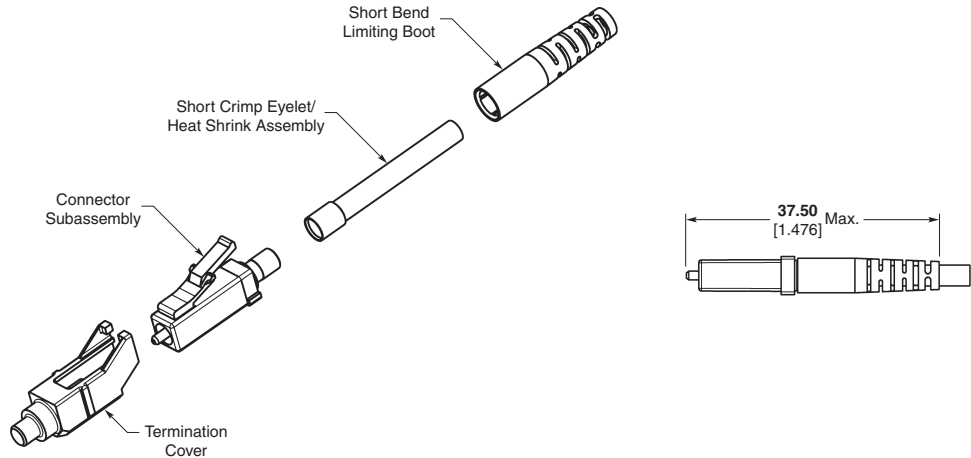

Description	Fiber Type	Housing Color	Boot Color	Used with	Installation Pack Part Number
Simplex	Singlemode	Blue	Blue	1.6-2.0 mm Jacketed	2064687-1

Note: All part numbers are RoHS compliant.

LC Connector Components

**LC Components —
1.6-2.4 mm Jacketed Cable
(Order One of Each
Component Excluding Clip
for Simplex, Two of Each
Plus One Clip for Duplex)**

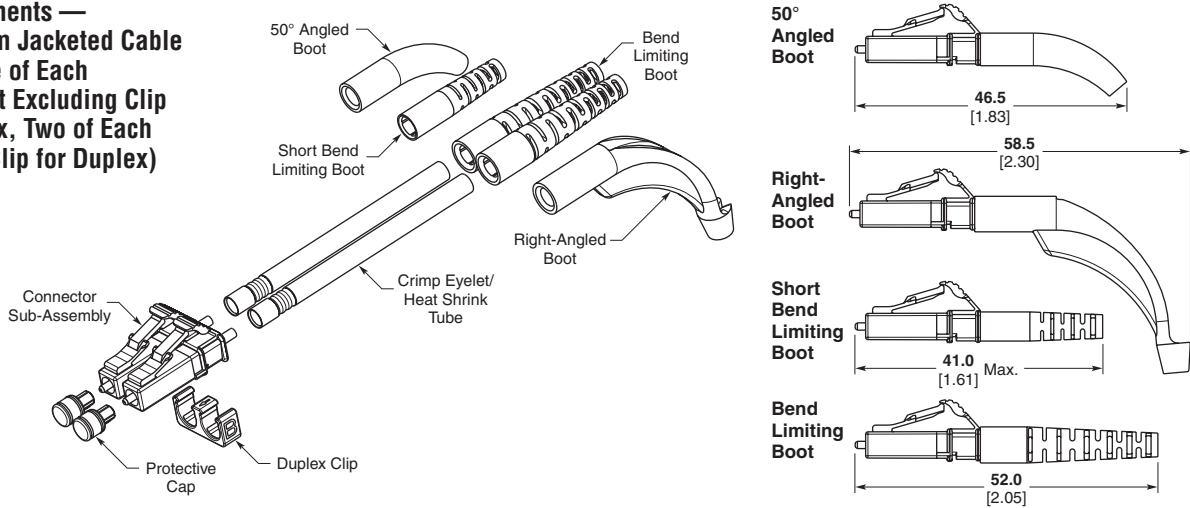

Fiber Type	Simplex Connector Sub-Assembly & Protective Cap	Duplex Clip	Cable Size	Crimp Eyelet with Heat Shrink Tube	Boot Description	Boot Part Number (see chart page 33)
Singlemode (Blue Hsg.)	1828456-1	1754371-4	1.6-2.0 mm	1918918-2	Short Bend Limiting	1918403-x
					Bend Limiting	1588153-x
			2.4 mm	6588189-1	Right-Angled	1374737-x
					50 Degree Angled	6457543-x
					Bend Limiting	1588153-x
Multimode (Beige Hsg.)	1754625-1	1754371-5	1.6-2.0 mm	1918918-1	Short Bend Limiting	1918403-x
					Bend Limiting	1588153-x
			2.4 mm	6588189-1	Right-Angled	1374737-x
					50 Degree Angled	6457543-x
					Bend Limiting	1588153-x
					Right-Angled	1374737-x
					50 Degree Angled	6457543-x

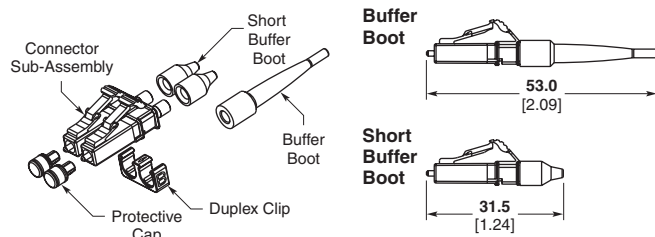

**LC Components — 900 μm Buffered Fiber
(Order One of Each Component Excluding Clip for Simplex,
Two of Each Plus One Clip for Duplex)**

Fiber Type	Simplex Connector Sub-Assembly & Protective Cap	Duplex Clip	Boot Description	Boot Part Number (see chart page 33)
Singlemode (Blue Hsg.)	1828456-1	1754371-4	Buffer	1828184-x
			Short Buffer	6588612-x
Multimode (Beige Hsg.)	1754625-1	1754371-5	Buffer	1828184-x
			Short Buffer	6588612-x

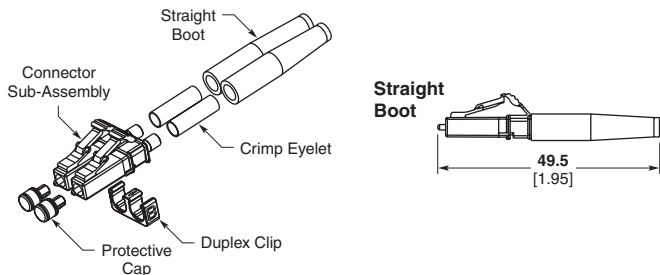

**LC Components — 3.0 mm Jacketed Cable
(Order One of Each Component Excluding Clip for Simplex,
Two of Each Plus One Clip for Duplex)**

Fiber Type	Simplex Connector Sub-Assembly & Protective Cap	Duplex Clip	Crimp Eyelet	Boot Part Number (see chart page 33)
Singlemode (Blue Hsg.)	1828456-1	1754371-4	5504118-3	502716-x
Multimode (Beige Hsg.)	1754625-1	1754371-5	5504118-3	502716-x

Instruction Sheet: 408-8675

Note: All part numbers are RoHS compliant.

**LC Components —
1.6 to 2.4 mm Boots**



**Short Bend Limiting Boot for
1.6 to 2.0 mm Cable**

Base Part Number	Beige	Blue	Black
1918403	-2	-1	—



**Right-Angled Boot for
1.6 to 2.4 mm Cable**

Base Part Number	Beige	Blue	Black
1374737	-2	-1	-3



**Bend Limiting Boot for
1.6 to 2.4 mm Cable**

Base Part Number	Beige	Blue	Black
1588153	-5	-2	-3



**50 Degree Angle Boot for
1.6 to 2.4 mm Cable**

Base Part Number	Beige	Blue	Black
6457543	-1	-2	-4

**LC Components —
900 µm Boots**



Buffer 900 µm Boot

Base Part Number	Beige	Blue	Black
1828184	-4	-1	-2



Short Buffer 900 µm Boot

Base Part Number	Beige	Blue	Black
6588612	-1	-2	-5

**LC Components —
3.0 mm Boots**



Straight Boot for 3.0 mm Cable

Base Part Number	Beige	Blue	Black
502716	-3	-4	-1

Note: All part numbers are RoHS compliant.

LC Adapters

LC Duplex Adapter for SC Cutout — Plastic



Alignment Sleeve Material	Description	Housing Color	Part Numbers
Metal	Flanged	Beige	6457567-8
		Black	2-6457567-1
		Aqua	2-6457567-0
		Blue	1-6457567-3
	Flangeless	Beige	6457567-7
		Black	1-6457567-9
		Aqua	1-6457567-8
		Blue	6457567-5
Ceramic	Flanged	Black	1-6457567-7
		Aqua	1-6457567-6
		Blue	6457567-4
		Green	6457567-6
	Flangeless	Beige	6457567-2
		Black	1-6457567-5
		Aqua	1-6457567-4
		Blue	6457567-1
		Green	6457567-3

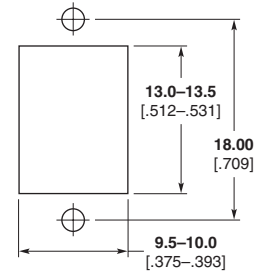

Recommended Panel Cutout
Max. Panel Thk. 1.70 [0.067]

Shuttered LC Duplex Adapter for SC Cutout — Plastic



Alignment Sleeve Material	Description	Housing Color	Shutter Label Color	Part Number
Ceramic	Flanged	Beige	Beige	2064658-5
		Black	Beige	1-2064658-7
		Aqua	Aqua	1-2064658-6
		Blue	Blue	2064658-4
	Flangeless	Green	Green	2064658-6
		Beige	Beige	2064752-2
		Black	Beige	1-2064752-3
		Aqua	Aqua	1-2064752-4
		Blue	Blue	2064752-1
		Green	Green	2064752-3

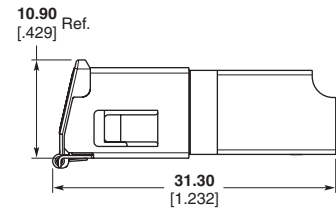

LC Duplex Adapter for SC Cutout — Metal

Alignment Sleeve Material	Description	Housing Color	Part Number
Ceramic	Flanged		1754683-1
	Flangeless		1754682-1
	Flanged with Shutter	Electroless Nickel	2064685-1
	Flangeless with EMI Shield		1754727-1

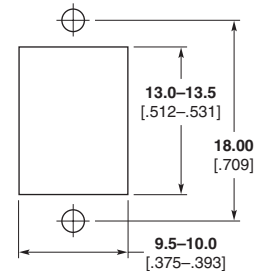

Recommended Panel Cutout
Max. Panel Thk. 1.70 [0.067]

Note: All part numbers are RoHS compliant.

LC Adapters (Continued)



LC Duplex Adapter for LC Cutout — Plastic

Alignment Sleeve Material	Description	Housing Color	Part Numbers
Metal	Duplex Sr-Jr	Beige	1985150-4
		Blue	1985150-3
	Duplex Sr-Sr	Beige	1985149-4
		Blue	1985149-3
Ceramic	Duplex Sr-Jr	Beige	1985150-2
		Blue	1985150-1
	Duplex Sr-Sr	Beige	1985149-2
		Blue	1985149-1

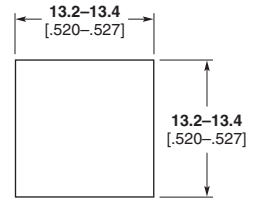

Recommended Panel Cutout
Panel Thk. 1.2/1.7 [.047/.067]



LC Simplex Adapter — Plastic

Alignment Sleeve Material	Description	Housing Color	Part Numbers
Ceramic	Simplex Adapter	Beige	1457062-2
		Blue	1457062-1

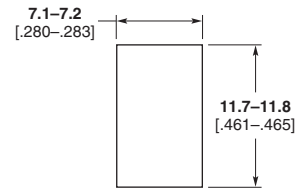

Recommended Panel Cutout
Panel Thk. 1.2/1.7 [.047/.067]



LC Quad Adapter — Plastic Flanged

Alignment Sleeve Material	Description	Housing Color	Part Numbers
Metal	Flanged	Beige	1695790-5
Ceramic	Flanged	Blue	1695790-4

Note: All part numbers are RoHS compliant.

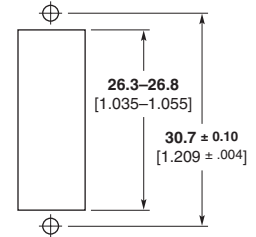

Recommended Panel Cutout
Max. Panel Thk. 1.7 [.067]

Note: All part numbers are RoHS compliant.

SC Connector Kits

SC Connector Kits — Standard Kits

Product Facts

- Compliant with
 - JIS C-5973
 - Fibre Channel
 - TIA FOCIS-3
- One-piece connector body
- Compatible with anaerobic adhesives
- Instruction Sheet 408-8674
- Components packaged in 25 piece bags for easy access
- Field installable duplex clip (6348522-1) available
- Mates with SC adapters (pages 39-41), SC Transceivers



Performance (typical)

Insertion Loss — 0.2dB
 Reflectance — -55dB
 Operating Temperature — -40° C to +75° C

Material

Ferrule — Zirconia
 Housing and Connector Body — UL 94 V-0 rated thermoplastic

Length — Ferrule Tip to End of Boot

900 µm Buffered — 54 mm
 2.0 mm Jacketed — 50 mm
 3.0 mm Jacketed — 50 mm

Description	Fiber Type	Housing Color	Boot Color	Used with	Assembly Pack Part Number
Simplex	Singlemode	Blue	Blue	900 µm Buffered	2064939-1
				2.0 mm Jacketed	2064939-2
				3.0 mm Jacketed	2064939-3
	Multimode	Beige	Beige	900 µm Buffered	2064940-1
				2.0 mm Jacketed	2064940-2
				3.0 mm Jacketed	2064940-3
Duplex	Singlemode	Blue	Blue	2.0 mm Jacketed	5504936-2
				3.0 mm Jacketed	5504655-2
				2.0 mm Jacketed	5504927-1
	Multimode	Beige	Beige	2.0 mm Jacketed	5504657-1
				3.0 mm Jacketed	5504657-1
				3.0 mm Jacketed	5504657-1

SC Connector Kits — Tight Jacketed Kits

Product Facts

- Non pull-proof connector for use with tight jacketed fiber cable
- Allows jacket and buffer to move together to prevent micro-bends and fiber breakage
- SC Commercial Item Description (CID) interim approval by Naval Surface Warfare Center, Dahlgren Division
- Tested using MIL-PRF-85045/16 2.0 mm cable



Material

Ferrule — Zirconia
 Housing — UL 94 V-0 rated thermoplastic

Length — Ferrule Tip to End of Boot: 57.0 mm

Engineering Report
 502-1191

Description	Fiber Type	Housing Color	Boot Color	Used with	Individual Pack Part Number	Bulk Pack Part Number
Simplex	Singlemode	Blue	Blue	1.6-2.0 mm Jacketed	6828100-1	6828100-2
				2.4 mm Jacketed	1918227-1	1918227-2
	Multimode	Beige	Beige	1.6-2.0 mm Jacketed	6828099-1	6828099-2
				2.4 mm Jacketed	1918154-1	1918154-2
Duplex	Singlemode	Blue	Blue	1.6-2.0 mm Jacketed	1828573-1	1828573-2
	Multimode	Beige	Beige	1.6-2.0 mm Jacketed	1828574-1	1828574-2

Applications

- In flight networks
- Shipboard applications
- Aero market

Note: All part numbers are RoHS compliant.

SC Connector Components

**SC Components —
2.0 – 3.0 mm Jacketed
Cable (Order One of Each
Component Excluding Clip
for Simplex, Two of Each
for Duplex)**

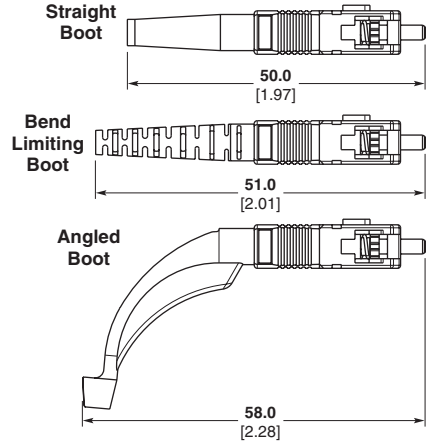
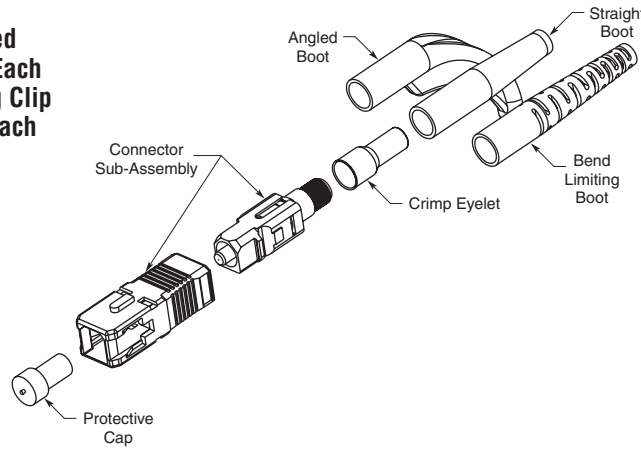

Fiber Type	Simplex Connector Sub-Assembly & Protective Cap	Duplex Clip	Cable Size	Crimp Eyelet	Boot Description	Boot Part Number (see chart page 38)
Singlemode (Blue Outer Hsg.)	5492123-7	6348522-1	2.0 mm	503970-9	Straight	5503971-x
			2.4 mm	503970-6	Straight	5503971-x
			3.0 mm	503970-3	Straight	5503971-x
					Bend Limiting	1588491-x
					Angled	1278705-x
Multimode (Beige Outer Hsg.)	5503948-7	6348522-1	2.0 mm	503970-9	Straight	5503971-x
			2.4 mm	503970-6	Straight	5503971-x
			3.0 mm	503970-3	Straight	5503971-x
					Bend Limiting	1588491-x
					Angled	1278705-x

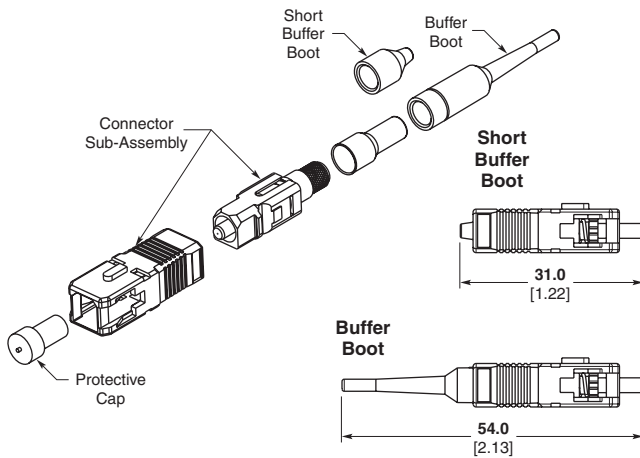

**SC Components — 900 µm Buffered Fiber
(Order One of Each Component Excluding Clip for Simplex,
Two of Each for Duplex)**

Fiber Type	Simplex Connector Sub-Assembly & Protective Cap	Duplex Clip	Boot Description	Boot Part Number (see chart page 38)
Singlemode (Blue Outer Hsg.)	5492123-7	6348522-1	Short Buffer	6278309-x
			Buffer	6457493-x
Multimode (Beige Outer Hsg.)	5503948-7	6348522-1	Short Buffer	6278309-x
			Buffer	6457493-x

**SC Components —
Duplex Clip**



**SC Duplex Clip (Black)
Part Number 6348522-1**

Use 2 pieces to create one clip for duplexing simplex housings

Note: All part numbers are RoHS compliant.

SC Connector Components (Continued)

**SC Components —
2.0 to 3.0 mm Boots**

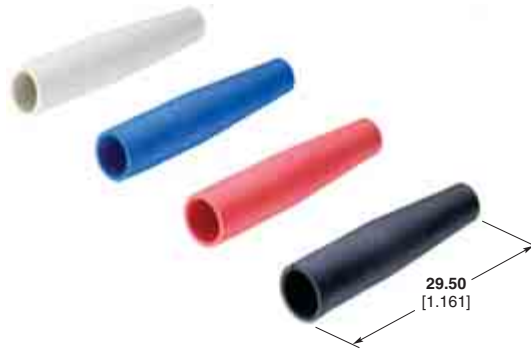

Straight Boot for 2.0 to 3.0 mm Cable

Cable Size	Beige	Blue	Black	Red
2.0 mm	5503971-5	5503971-6	2-5503971-3	2-5503971-7
2.4 mm	5503971-3	5503971-4	1-5503971-2	1-5503971-3
3.0 mm	5503971-1	5503971-2	1-5503971-0	1-5503971-1



Bend Limiting Boot for 3.0 mm Cable

Base Part Number	Beige	Blue	Black
1588491	-5	-2	—



Angled Boot for 3.0 mm Cable

Base Part Number	Beige	Blue	Black
1278705	-2	-1	-3

**SC Components —
900 μm Boots**



Buffer 900 μm Boot

Base Part Number	Beige	Blue	Black
6457493	-9	-1	-3



Short Buffer 900 μm Boot

Base Part Number	Beige	Blue	Black
6278309	—	-2	-1

Note: All part numbers are RoHS compliant.

SC Adapters

SC to SC Adapters



SC Simplex Adapter — Plastic

SC Simplex Adapter — Plastic

Alignment Sleeve Material/Application	Housing Color	Part Numbers
Metal/MM only	Beige	5504614-1
	Black	5504614-4
	Aqua	5504614-3
Metal	Beige	5502632-9
	Black	5502632-7
	Aqua	2-5502632-3
Ceramic	Blue	5502632-8
	Beige	1-5502632-2
	Black	1-5502632-0
Ceramic/APC	Aqua	2-5502632-4
	Blue	1-5502632-1
	Green	1828028-2

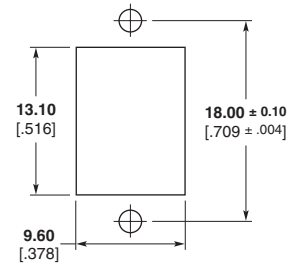

Recommended Panel Cutout
Max. Panel Thk. 1.7 [.067]



Flangeless SC Simplex Adapter — Plastic

Flangeless SC Simplex Adapter — Plastic

Alignment Sleeve Material	Housing Color	Part Numbers
Metal	Black	5504632-1
	Blue	5504632-3
	Black	5504632-2
Ceramic	Aqua	5504632-6
	Blue	5504632-4
	Green	5504632-5

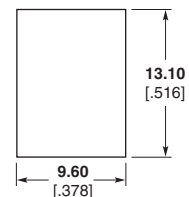

Recommended Panel Cutout
Max. Panel Thk. 1.7 [.067]



SC Simplex Adapter — Metal

SC Simplex Adapter — Metal

Alignment Sleeve Material	Housing Color	Part Numbers
Metal	Electroless Nickel	6278348-1
Ceramic	Electroless Nickel	6278348-3

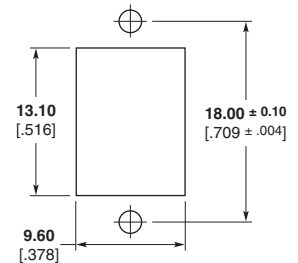

Recommended Panel Cutout
Max. Panel Thk. 1.7 [.067]



Flangeless SC Simplex Adapter — Metal

Flangeless SC Simplex Adapter — Metal

Alignment Sleeve Material	Housing Color	Part Numbers
Metal	Electroless Nickel	6278348-5
Ceramic	Electroless Nickel	6278348-7

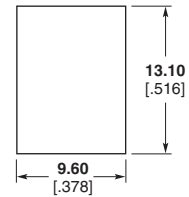

Recommended Panel Cutout
Max. Panel Thk. 1.7 [.067]



SC Duplex Adapter — Plastic

SC Duplex Adapter — Plastic

Alignment Sleeve Material/Application	Housing Color	Part Numbers
Metal/MM only	Beige	5504640-1
	Black	5504640-4
	Aqua	5504640-6
Metal	Beige	5502776-9
	Black	5502776-7
	Aqua	2-5502776-5
Ceramic	Blue	5502776-8
	Beige	1-5502776-2
	Black	1-5502776-0
Ceramic/APC	Aqua	2-5502776-6
	Blue	1-5502776-1
	Green	2-5502776-3

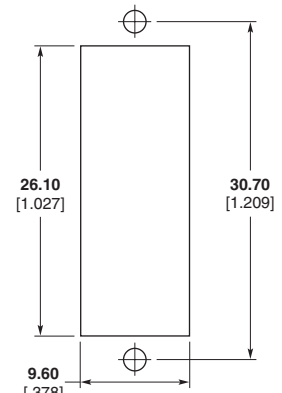

Recommended Panel Cutout
Max. Panel Thk. 1.7 [.067]

Note: All part numbers are RoHS compliant.

SC Adapters (Continued)

SC to SC Adapters
(Continued)



SC Duplex Adapter

SC Duplex Adapter — Metal

Alignment Sleeve Material	Housing Color	Part Numbers
Metal	Electroless Nickel	6278049-1
Ceramic	Electroless Nickel	6278049-3



SC Duplex Metal Adapter
w/ EMI Shielding

Shielded SC Duplex Adapter — Metal

Alignment Sleeve Material	Housing Color	Part Numbers
Metal	Electroless Nickel	6374223-1
Ceramic	Electroless Nickel	6374223-3

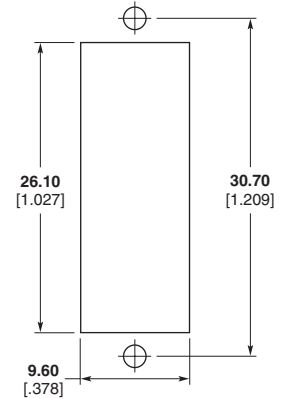

Recommended Panel Cutout
Max. Panel Thk. 1.7 [.067] For
SC Duplex Adapter — Metal and
Shielded SC Duplex Adapter —
Metal

SC to ST Hybrid Adapters



SC to ST Simplex Adapter —
Plastic

SC to ST Simplex Adapter — Plastic

Alignment Sleeve Material	Housing Color	Part Numbers
Metal	Beige	5502780-3
	Black	5502780-1
	Aqua	2-5502780-0
	Blue	5502780-2
Ceramic	Beige	5502780-6
	Black	5502780-4
	Aqua	2-5502780-1
	Blue	5502780-5

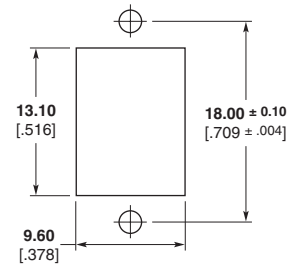

Recommended Panel Cutout
Max. Panel Thk. 1.7 [.067]

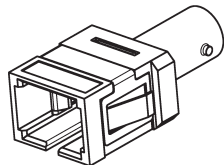

Flangeless SC to ST Simplex
Adapter — Plastic

Flangeless SC to ST Simplex Adapter — Plastic

Alignment Sleeve Material	Housing Color	Part Numbers
Metal	Black	5504634-1
Ceramic	Black	5504634-2

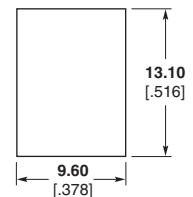

Recommended Panel Cutout
Max. Panel Thk. 1.7 [.067]



SC to ST Simplex Adapter —
Metal

SC to ST Simplex Adapter — Metal

Alignment Sleeve Material	Housing Color	Part Numbers
Metal	Electroless Nickel	6278350-1
Ceramic	Electroless Nickel	6278350-3

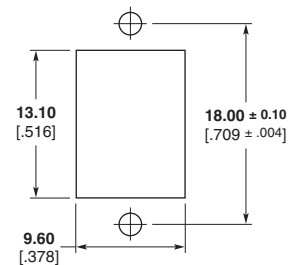

Recommended Panel Cutout
Max. Panel Thk. 1.7 [.067]

Note: All part numbers are RoHS compliant.

SC Adapters (Continued)

SC to ST Hybrid Adapters
(Continued)



Flangeless SC to ST Simplex Adapter — Metal

Flangeless SC to ST Simplex Adapter — Metal

Alignment Sleeve Material	Housing Color	Part Numbers
Metal	Electroless Nickel	6278350-5
Ceramic	Electroless Nickel	6278350-7

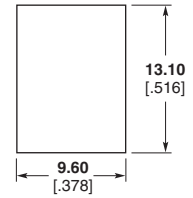

Recommended Panel Cutout
Max. Panel Thk. 1.7 [0.067]



SC to ST Duplex Adapter — Plastic

SC to ST Duplex Adapter — Plastic

Alignment Sleeve Material	Housing Color	Part Numbers
Metal (MM Only)	Beige	5504663-4
	Black	5504663-6
	Aqua	5504663-5
Metal	Beige	5503137-3
	Black	5503137-1
	Aqua	2-5503137-1
	Blue	5503137-2
Ceramic	Beige	5503137-6
	Black	5503137-4
	Aqua	1-5503137-9
	Blue	5503137-5

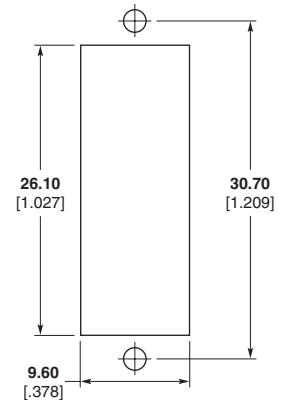

Recommended Panel Cutout
Max. Panel Thk. 1.7 [0.067]



SC to ST Duplex Adapter — Metal

SC to ST Duplex Adapter — Metal

Alignment Sleeve Material	Housing Color	Part Numbers
Metal	Electroless Nickel	6278051-1
Ceramic	Electroless Nickel	6278051-3

Slide-on Retractable Cover for SC Simplex or Duplex Applications

These retractable doors slip onto the end of existing Tyco Electronics adapters and can be mounted after the adapter has already been installed.



Part Number 1693539-1 — Blue Simplex SC



Part Number 1693540-1 — Blue Duplex SC

Part Number 1693539-2 — Beige Simplex SC

Part Number 1693540-2 — Beige Duplex SC

Note: All part numbers are RoHS compliant.

ST Connector Kits

ST Connector Kits — Ceramic Ferrules

Singlemode Ceramic

Insertion Loss — 0.3dB
Reflectance — -40dB
Operating Temperature — -20° C to +75° C
Durability — 200 Cycles

Multimode Ceramic

Insertion Loss — 0.3dB
Operating Temperature — -20° C to +75° C
Durability — 500 Cycles



Length — Ferrule Tip to End of Boot
900 μm Buffered — 56.4 mm
3.0 mm Jacketed — 47.25 mm
3.0 mm Right-Angle — 58.0 mm

Instruction Sheet
408-9971

Fiber Type	Body	Coupling Nut	Boot Color	Used with	Individual Pack Part Number
Singlemode	Nickel-plated Brass	Zinc	Yellow (900 μm)	900 μm Buffered 250 μm Buffered	5503613-2
			Yellow (3.0 mm)	900 μm Buffered 250 μm Buffered 3.0 mm Cable	5502580-2
Multimode	Polymer	Polymer	Black (3.0 mm)	900 μm Buffered 3.0 mm Cable	503571-1
	Nickel-plated Brass	Zinc	Black (900 μm) Black (3.0 mm)	900 μm Buffered 3.0 mm Cable	5492458-1
			Black (Right-Angle)	900 μm Buffered 3.0 mm Cable	5502674-1

ST Connector Kits — Polymer Ferrule

Multimode Polymer Composite

Insertion Loss — 0.3dB
Operating Temperature — -20° C to +75° C
Durability — 500 Cycles

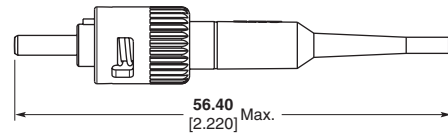
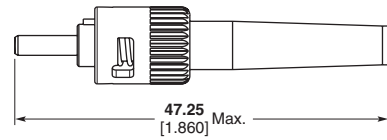

Instruction Sheet
408-9971

Fiber Type	Body	Coupling Nut	Boot Color	Used with	Individual Pack Part Number
Multimode	Polymer	Polymer	Black (900 μm) Black (3.0 mm)	900 μm Buffered 250 μm Buffered 3.0 mm Cable	5503415-1

ST Connector Kits — Stainless Steel Ferrule

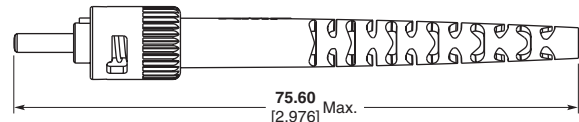

Bend Limiting Boot

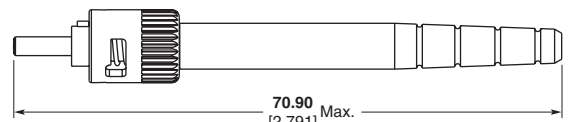

Long Boot

Multimode Stainless Steel

Insertion Loss — 0.3dB
Operating Temperature — -30° C to +70° C
Durability — 500 Cycles
Instruction Sheet
408-4151

Fiber Type	Body	Coupling Nut	Ferrule Designation	Boot Color	Used with	Part Number
Multimode	Nickel-plated Brass	Zinc	125	Black (Bend Limiting)	3.0 mm Cable	5504008-3
			125	Black (Long)	4.3 mm Cable	5504008-4
			140	Black (Bend Limiting)	3.0 mm Cable	5504008-7
			231	Black (Bend Limiting)	3.0 mm Cable	1-5504008-4
			240	Black (Bend Limiting)	3.0 mm Cable	1-5504008-3
			280	Black (Bend Limiting)	3.0 mm Cable	4-5504008-6

Note: All part numbers are RoHS compliant.

**ST Components —
2.0 to 3.0 mm Boots**

ST Connector Components



Straight Boot for 2.0 to 3.0 mm Cable

Cable Size	Beige	Blue	Black
2.0 mm	503219-4	503219-5	503219-1
3.0 mm	501457-4	501457-5	501457-1



Bend Limiting Boot for 3.0 mm Cable

Base Part Number	Beige	Blue	Black
502128	-4	-7	-1



Right Angled Boot for 3.0 mm Cable

Base Part Number	Beige	Blue	Black
5502667	-3	-2	-1



Buffer 900 μm Boot

Base Part Number	Beige	Blue	Black
5503628	-19	-8	-1

ST Coupling Receptacles



Alignment Sleeve Material	Part Number
Polymer Composite (Multimode)	501381-1
Metal (Multimode)	504021-1
Ceramic (Singlemode)	502750-1

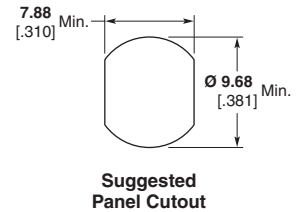

ST Active Device Mounts — Multimode

Product Facts

- Designed to accept multimode TO-18, TO-46 and TO-52 active devices
- Nickel plated, die cast zinc
- Mount to PCB or through panel
- Includes positioning ring



Description	Packaging	Height	Part Number
Standard height	Single	.410	5501474-1
Low profile	Single	.280	5502585-2
Low profile	Single (100)	.314	5504022-2
Low profile	Bulk (50)	.314	5504022-3

Note: All part numbers are RoHS compliant.

FC Connector Kits

FC Connector Kits — Ceramic Ferrules



Singlemode Ceramic
Insertion Loss — 0.2dB
Reflectance — -59dB
Durability — 200 Cycles

Length — Ferrule Tip to End of Boot
900 μm buffered — 35.0 mm
2.0 mm jacketed — 51.0 mm
3.0 mm jacketed — 51.0 mm

Instruction Sheet
408-8674

FC Connector Kits — Standard Kits

Fiber Type	Boot Color	Used with	Part Number
Singlemode	Blue	900 μm Buffered	6754264-2
		2.0 mm Jacketed	5504915-2
		3.0 mm Jacketed	5504649-1

FC Adapters

FC to FC Adapters



FC Square Flange Adapter

FC Simplex Square Flange Adapter — Metal

Alignment Sleeve Material	Panel Cut-out	Keyway Slot (Nom.)	Part Numbers
Metal	Square Flange	Std.	5501506-2
		2.33 mm	
Ceramic	Square Flange	Std.	5501506-1
		2.33 mm	

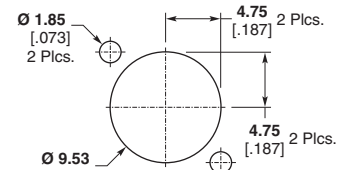

Recommended Panel Cutout
Max. Panel Thk. 1.70 [.067]



FC 8 mm/9 mm Dia. Round

FC Simplex 8 mm/9 mm Dia. Round (D-Hole) Adapter — Metal

Alignment Sleeve Material	Panel Cut-out	Keyway Slot (Nom.)	Part Numbers
Metal (Copper)	D-Hole	Std.	5504407-1
		2.33 mm	
Ceramic	D-Hole	Std.	5504407-3
		2.33 mm	
Ceramic/APC	D-Hole	2.05 mm Type R	5504407-8
		Prec.	
Ceramic/APC	D-Hole	2.02 mm	5504407-7

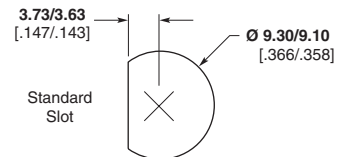

Recommended Panel Cutout
Max. Panel Thk. 1.65 [.065]



FC 8 mm Dia. Round (Double D)

FC Simplex 8 mm Dia. Round (Double D-Hole) Adapter — Metal

Alignment Sleeve Material	Panel Cut-out	Keyway Slot (Nom.)	Part Numbers
Metal	Double D-Hole	Std. 2.33 mm	5504013-1

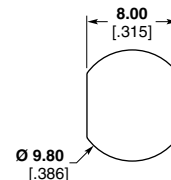

Recommended Panel Cutout
Max. Panel Thk. 1.65 [.065]

Note: All part numbers are RoHS compliant.

FC Adapters (Continued)

FC to ST Hybrid Adapters



FC to ST Simplex Adapter — Metal

Hybrid FC to ST Simplex Adapter — Metal

Alignment Sleeve Material	Housing Color	Part Numbers
Metal	Electroless Nickel	5503640-1
Ceramic	Electroless Nickel	5503640-2

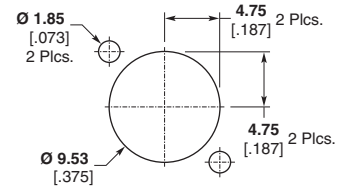

Recommended Panel Cutout
Max. Panel Thk. 1.70 [.067]

FC to SC Hybrid Adapters



SC to FC Simplex Adapter — Plastic

SC to FC Simplex Adapter — Plastic

Alignment Sleeve Material	Housing Color	Part Numbers
Metal	Black	5502781-1
Ceramic	Black	5502781-4

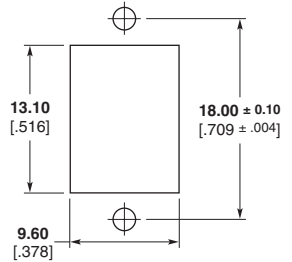

Recommended Panel Cutout
Max. Panel Thk. 1.7 [.067]



SC to FC Simplex Adapter — Metal

SC to FC Simplex Adapter — Metal

Alignment Sleeve Material	Housing Color	Part Numbers
Metal	Electroless Nickel	6278349-1
Ceramic	Electroless Nickel	6278349-3

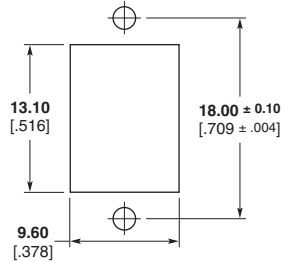

Recommended Panel Cutout
Max. Panel Thk. 1.7 [.067]



Flangeless SC to FC Simplex Adapter — Metal

Flangeless Simplex Adapter — Metal

Alignment Sleeve Material	Housing Color	Part Numbers
Metal	Electroless Nickel	6278349-5
Ceramic	Electroless Nickel	6278349-7

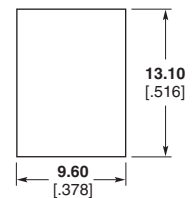

Recommended Panel Cutout
Max. Panel Thk. 1.7 [.067]



SC to FC Duplex Adapter — Metal

SC to FC Duplex Adapter — Metal

Alignment Sleeve Material	Housing Color	Part Numbers
Metal	Electroless Nickel	6278050-1
Ceramic	Electroless Nickel	6278050-3

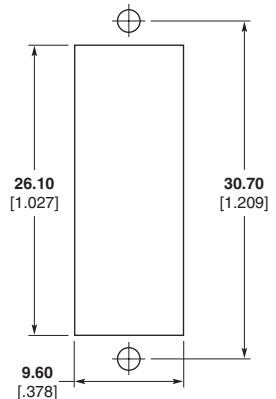

Recommended Panel Cutout
Max. Panel Thk. 1.7 [.067]

Note: All part numbers are RoHS compliant.

ESCON Connector Components

ESCON Connector Plug

Product Facts

- Multimode
- IBM Approved
- Simple field assembly

Performance Characteristics

Assembly Loss — 0.2 dB Typical

Durability — 200 cycles

Instruction Sheet

408-9808

<http://www.tycoelectronics.com/documents>



Description	Part Number
125 μ m	Black
DUALAN Cable	5492181-1
DUALAN Cable	5492181-2*

* Bulk packed, 50 per package
Termination Kit: 503746-6.

FSMA Products — Multimode

Product Facts

- Industry compatible with 905 (FSMA-I) and 906 (FSMA-II) style connectors
- Terminates fiber sizes from 125 through 1000 microns in diameter
- Design parameters conform to NATO and IEC interface standards



Performance Characteristics

Insertion Loss — 1.3 dB Typical

Temperature Range —

-55° C to +105° C

Durability — 200 cycles

Length —

Ferrule Tip to End of Boot

Part Number 5504566 — 70 mm

Part Number 5504014 — 70 mm

Part Number 5504567 — 66 mm

Documentation

Product Specification

108-45106

Instruction Sheet

408-9863

FSMA 905 & 906

Test Report

501-359

<http://www.tycoelectronics.com/documents>

FSMA Connectors

Ferrule Material	Connector Body Material	Fiber Diameter (μ m)	Nominal Jacket O.D.		
			3.1 mm		4.3 mm
			905	906	905
Stainless Steel	Nickel-Plated Brass	125	5504566-1	5504014-1	5504567-1
		140	5504566-2	1-5504014-0	5504567-2
		231	5504566-7	—	—
		336	1-5504566-4	—	—
		1000	3-5504566-0	—	—
		1050	3-5504566-1	—	2-5504567-9

Adapter

Product Facts

- Precision mating adapter for all FSMA connectors
- In-line splice or panel mount design



FSMA Adapters

Description	Part Number
Hex Flange, Stainless Steel	501049-1
Hex Flange, Stainless Steel, Counterbore, Sealed	501050-1
Fixed Flange, Nickel-Plated Brass	5504026-1
In-Line, Stainless Steel	504028-1
In-Line, Stainless Steel, Counterbore, Short	504031-1

Active Device Mount

Product Facts

- Designed to house TO-18, TO-46, and TO-52 devices
- Constructed of nickel plated die cast zinc alloy or stainless steel
- Mounts to PC board or through panel



FSMA Active Device Mounts

Description	Part Number
PC Mount Receptacle, Die Cast	5502136-1
PC Mount Receptacle, Die Cast, Bulk Packaged	5502136-2
PC Mount Receptacle, Stainless Steel	501055-1

Note: All part numbers are RoHS compliant.

ESCON is a trademark of IBM Corporation.

IBM is a trademark of International Business Machine Corporation.

MTRJ Connectors

MT-RJ Plugs

Product Facts

- Designed to meet TIA/EIA 568-B.3
- Each MT-RJ connector houses two fibers
- Half the size of duplex SC and ST Connectors
- Options available include:
 - Multimode or singlemode
 - Mini DUALAN or Mini Zipcord cable
 - With or without guide pins
 - **MT-RJ SECURE Connector Kits**

Performance Characteristics

Insertion Loss — Typical (dB) 0.2 dB

Operating Temperature —
-10° C to 60° C

Durability — 500 Cycles

Instruction Sheet

408-4540

<http://www.tycoelectronics.com/documents>



Standard MT-RJ Connectors

Fiber Type	Cable Type	Pins	Part Number
Singlemode	3.0 mm DUALAN	Without Guide Pins	6278399-1
	3.0 mm DUALAN	With Guide Pins	6278399-2
	1.8 mm Mini Zipcord	Without Guide Pins	6278751-1
	1.8 mm Mini Zipcord	With Guide Pins	6278751-2
Multimode	3.0 mm DUALAN	Without Guide Pins	6278398-1
	3.0 mm DUALAN	With Guide Pins	6278398-2
	1.8 mm Mini Zipcord	Without Guide Pins	6278750-1
	1.8 mm Mini Zipcord	With Guide Pins	6278750-2

MT-RJ SECURE Connectors

Fiber Type	Cable Type	Pins	Color	Part Number
Multimode	1.8 mm Mini Zipcord	Without Guide Pins	Red	1918356-1
			Yellow	1918356-2
			Green	1918356-3
			Blue	1918356-4
			Rose	1918356-5
			Aqua	1918356-6
			Brown	1918356-7
			Violet	1918356-8
			Orange	1918356-9
			Slate	1-1918356-0

MT-RJ to MT-RJ Adapter

MT-RJ to MT-RJ Simplex Adapter



Simplex Part Number
1278017-1 (light almond)

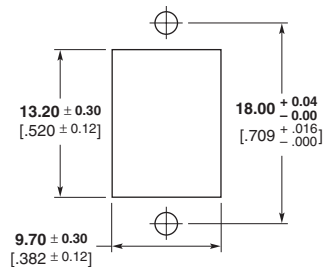

Recommended Panel Cutout
Max. Panel Thk. 1.7 [0.067]

MT-RJ to MT-RJ Duplex Adapter



Duplex Part Number
6374906-1 (Almond)

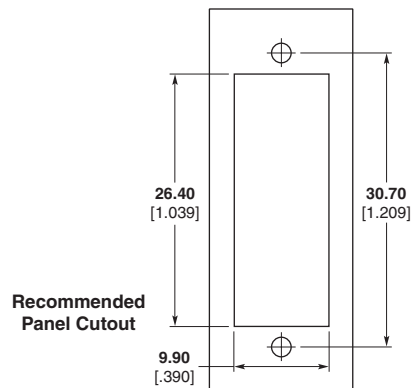

Recommended Panel Cutout

Note: All part numbers are RoHS compliant.

LIGHTCRIMP PLUS No Epoxy, No Polish LC, SC and ST Connectors

Product Facts

- Multimode connector kits come with accessories needed to terminate to 250 μm fiber, 900 μm tight-buffered fiber, and 900 μm easy-strip
 - SC and ST kits also terminate 3 mm cables
- Singlemode connector kits terminate to 250 μm fiber, 900 μm tight-buffered fiber, 900 μm easy-strip and buffer tube splitter kits
- Easy installation:
 - No epoxy, no polishing
 - No bench tool required
 - Strip, cleave and crimp
- Easy identification:
 - Singlemode is blue
 - Laser Optimized (10 Gig) is aqua — 10 Gb/s applications
 - 62.5/125 μm is beige
 - 50/125 μm is black
- Match fiber type of cable to fiber type of LIGHTCRIMP PLUS Connector
- Mates with standard couplers, adapters and adapter plates
- Tested to and meets TIA/EIA 568-B.3
- Termination tool kits on page 49

Performance Characteristics

Insertion Loss — Typical (dB)
0.2 dB Singlemode; 0.3 dB Multimode

Temperature Range —
-10° C to 60° C, tested to -40° C to 75° C

Durability — 500 cycles



Simplex LC Connector Kits — LIGHTCRIMP PLUS No Epoxy, No Polish Connector

Fiber Type	Housing Color	Boot Color	Used with	Part Number
Singlemode	Blue	Blue	900 μm & 250 μm Fibers	6754482-1
50/125 μm Multimode	Beige	Black	900 μm & 250 μm Fibers	6754483-2
Laser Optimized (10 Gig) (850 nm LO 50/125 μm) Multimode	Beige	Aqua	900 μm & 250 μm Fibers	6754483-4
62.5/125 μm Multimode	Beige	Beige	900 μm & 250 μm Fibers	6754483-1
Duplex LC Clip	Black	—	To convert Simplex kits for Duplex application	1754371-1



Simplex SC Connector Kits — LIGHTCRIMP PLUS No Epoxy, No Polish Connector

Fiber Type	Housing Color	Boot Color	Used with	Part Number
Singlemode Digital APC	Green	Blue	900 μm & 250 μm Fibers	2064184-1
Singlemode	Blue	Blue	900 μm & 250 μm Fibers, 3 mm Cable	6693276-1
50/125 μm Multimode	Beige	Black	900 μm & 250 μm Fibers, 3 mm Cable	6278079-2
Laser Optimized (10 Gig) (850 nm LO 50/125 μm) Multimode	Beige	Aqua	900 μm & 250 μm Fibers, 3 mm Cable	6588291-2
62.5/125 μm Multimode	Beige	Beige	900 μm & 250 μm Fibers, 3 mm Cable	5492643-1
Duplex SC Clip (use 2)	Black	—	To convert Simplex kits for Duplex application	6348522-1



ST Connector Kits — LIGHTCRIMP PLUS No Epoxy, No Polish Connector

Fiber Type	Housing Color	Boot Color	Used with	Part Number
50/125 μm Multimode	Metallic	Black	900 μm & 250 μm Fibers, 3 mm Cable	6278082-1
Laser Optimized (10 Gig) (850 nm LO 50/125 μm) Multimode	Metallic	Aqua	900 μm & 250 μm Fibers, 3 mm Cable	6278082-2
62.5/125 μm Multimode	Metallic	Beige	900 μm & 250 μm Fibers, 3 mm Cable	5492642-2

Note: All part numbers are RoHS compliant.

Tooling

LIGHTCRIMP PLUS Termination Tool Kits



Product Facts

- Includes all tools needed for installing the listed type LIGHTCRIMP PLUS no epoxy/no polish connectors, MT-RJ and MT-RJ SECURE Jacks
- LIGHTCRIMP PLUS Connector Termination Video CD-Rom also available separately, Part Number 1374503-1
- Convenient carrying case

Description	Part Number	
Universal LIGHTCRIMP PLUS No epoxy/No polish Tool Kit (SC, LC, ST and MT-RJ Jack)	1278118-4	1278118-5 ¹
LIGHTCRIMP PLUS LC Connector Termination Tool Kit	1754845-1	1754845-2 ¹
LIGHTCRIMP PLUS SC Connector Termination Tool Kit	1278022-1	1278022-2 ¹
LIGHTCRIMP PLUS ST Connector Termination Tool Kit	492697-1	492697-2 ¹

¹ Includes Precision Cleaver and Microscope.

LIGHTCRIMP PLUS Cable Holders

Product Facts

- Used in LIGHTCRIMP PLUS connector terminations (included in LIGHTCRIMP PLUS Tool Kits)

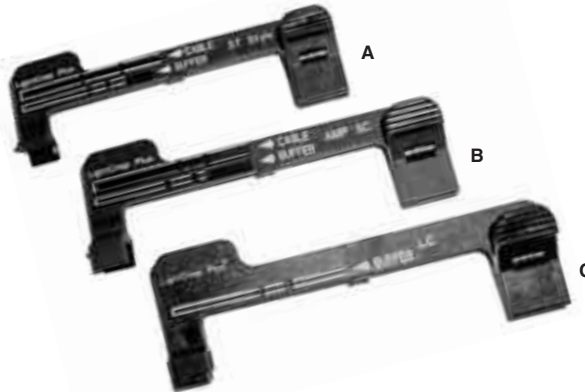

Description	Figure	Part Number
ST	A	492703-1
SC	B	1278023-1
LC	C	1754138-1
LC and SC	—	2064540-1

LIGHTCRIMP Cleave Tool Part Number 503705-1

Product Facts

- Used in both SC and ST LIGHTCRIMP Connector terminations
- Included in the Deluxe and LIGHTCRIMP Tool Kits



Note: All part numbers are RoHS compliant.

Tooling (Continued)

**Hand Held Precision
Cleaver**
Part Number 1871696-1

Product Facts

- Operator independent = no craft sensitivity = consistent cleave every time
- Hand held operation
- 10,000 cleave blade life
- 4, 6, 8, 10, and 18 millimeter cleave lengths
- Product specific markings for LIGHTCRIMP PLUS and MT-RJ jack connectors, CORELINK splice, and fusion splicing
- Cleave surface angle < 1.5°
- No lip, no fracture, and no roll-off
- Padded belt case for convenience and storage
- Neck lanyard included

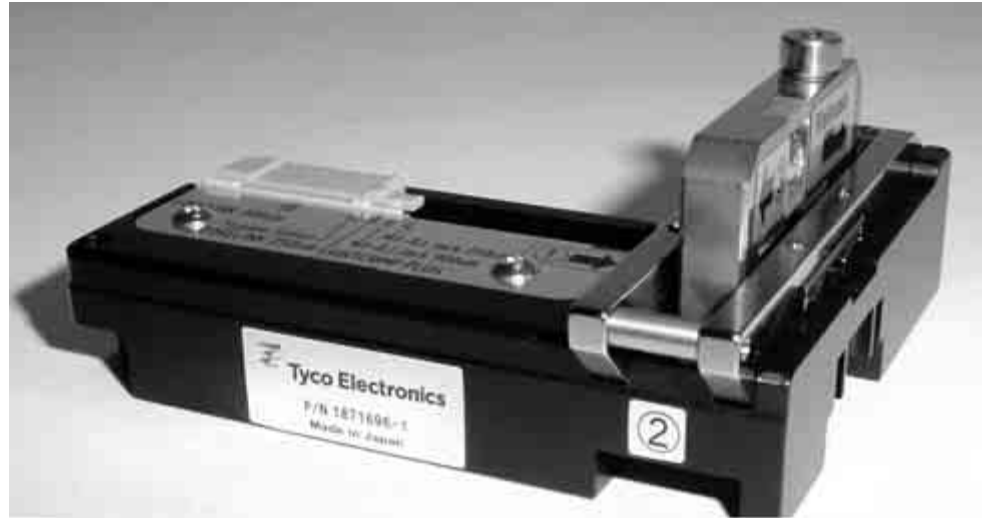

Tyco Electronics' hand held precision fiber cleaver provides precision quality cleaves with the feel and robustness of a full scale precision cleaver in a hand held size at an exceptionally competitive price. The detailed scale markings indicate proper cleave lengths for popular

Tyco Electronics field installable fiber optic connectors and mechanical splices in addition to the standard numerical markings for other applications including fusion splicing. The included belt pouch and neck lanyard ensure that the cleaver is always within reach.

Applications

Affordable precision cleaving solution for:

- Field installable mechanical splice connectors
- Fusion splicing
- Mechanical splicing
- Bare fiber adapters

Product Dimensions

Length — 74 mm [2.913 in.]
Width — 65.5 mm [2.578 in.]
Thickness — 33.5 mm [1.318 in.]
Weight — 136 g [0.30 lb.]

Note: All part numbers are RoHS compliant.

Tooling (Continued)

Epoxy/Polish Connector Termination Tool Kits

Product Facts

- Includes all tools necessary to install the listed epoxy/polish connectors
 - For LC terminations, also order Part Number 1754603-1
- Tool kits include:
 - Pro-Crimper II Hand Tool and crimping dies
 - Polishing bushings
 - Polishing film (also sold separately)
 - Cable and fiber strippers
 - Scissors
 - Scribe tool
- Includes polishing films to install » 60 epoxy/polish connectors
 - Epoxy is sold separately (see page 52)
- Does not include curing oven or microscope
- Convenient carrying case



Description	Part Number
SC and FC	503746-7
ST	503746-1
FSMA	503746-2
FSD	503746-6

Sapphire-Tipped Scribe Tool and Accessories

Product Facts

- Long-lasting sapphire blade
- Pen-type casing
- Used to install all Epoxy/Polish Connectors
- Included in Epoxy/Polish Tool Kits



Description	Part Number
Sapphire-tipped Scribe Tool	504064-1
Replacement Blades	504290-1

Note: All part numbers are RoHS compliant.

Tooling (Continued)

Epoxy/Polish LC Termination Accessories

Product Facts

- Supplement epoxy/polish tool kits on page 51 with these components to terminate LC Epoxy/Polish Connectors

- Different polishing films are required for LC polishing

Description	Part Number
LC Polishing Puck — Metal	1754074-1
LC Cable Preparation Template	1588756-1
LC Hand Tool and Die Set	1588176-1
LC 1.25 mm Ferrule Microscope Adapter	1278997-1
LC Oven Block Assembly	1457628-1
LC Adaptive Kit — Anaerobic Epoxy Style	1754603-1
LC Adaptive Kit — Heat Cure	1754462-1

EPO-TEK 353ND Epoxy
Part Number 504035-1



Product Facts

- For use with SC and LC Connectors
- Pre-measured two-part packets for consistent results
- Long pot life once mixed
- Heat-cured epoxy
- Supplied in 4-gram packets
- Cures in 15 minutes at 115° C

TRA-CON Epoxies
Part Number 1918652-1



Product Facts

- For use with SC, LC, and ST Connectors
- Pre-measured two-part packets for consistent results
- Can be heat-cured or cured at ambient temperature
- Supplied in 2-gram packets
- Each packet terminates » 250 connectors
- 25 packets per pack
- Pot life = 30 minutes
- Cures in:
 - 24 hours @ 25° C
 - 2 hours @ 65° C
 - 10 minutes @ 110° C

HYSOL Epoxy-Tubes
Part Number 502418-1



Product Facts

- For use with SC, LC, ST, FSD, FC, and FSMA Connectors
- Two-part epoxy in two tubes
- Heat-cured epoxy
- Terminates » 400 connectors
- One set of two (2) tubes per part number
- Pot life = 30 minutes
- Cures in 30 minutes at 100° C

Epoxy Applicator Syringe
Part Number 501473-3

Product Facts

- 3 cc capacity



Note: All part numbers are RoHS compliant.

EPO-TEK is a trademark of EPOXY TECHNOLOGY INC.

HYSOL is a trademark of HENKEL CORPORATION.

TRA-CON is a trademark of Tra-Con, Inc.

Tooling (Continued)

Hand Held Microscope

Product Facts

- High quality glass optics
 - 200X magnification
- Optimal visual examination of terminated ends
 - 500 µm field of view
- Dual illumination
 - Coaxial for inspecting polish quality
 - Oblique for general conditions
- Pre-centered, threaded adapter mount provides easy focusing and changing of connectors
- Field and laboratory examination for multimode and singlemode fibers
- Portable
- Integral infrared filter for safety
 - Do NOT use any microscope to view active fiber signals
- Disposable, Type LR44 batteries
- Long-life LED (approximately 100,000 hours of operation)
- Each Kit includes:
 - 10-power objective microscope with an impact resistant ergonomic rubber shell and high quality glass optics
 - 20-power eyepiece
 - Padded carrying case with an integrated belt loop and internal adapter storage pocket
 - Neck lanyard with safety breakaway feature
 - Universal 2.5 mm ferrule adapter (for SC, ST and FC)
- Other adapters available are:
 - Universal 1.25 mm (adapts LC and MU)
 - MT-RJ
 - MPO
 - MPO APC
 - LIGHTRAY MPX Connector
 - LIGHTRAY MPX APC Connector



Tyco Electronics' hand held microscope incorporates high quality glass optics and dual illumination lighting for unsurpassed 200X magnification. With a 500 µm Field of View (FOV) and both coaxial and oblique illuminations, this microscope will meet the proposed TIA/IEC hand held microscope specification for a polish quality scope (coaxial) and general conditions scope (oblique) in one compact unit.

The built in IR-laser attenuation filter will provide protection from accidental exposure to active fibers, although intentional and prolonged viewing of active fibers is not recommended. The ergonomic, impact resistant shell provides a rugged feel, and the included padded belt case and neck lanyard ensure that the microscope is always within reach.

Applications

Affordable inspection device for:

- Polish inspection
- General conditions (debris) inspection
- Cleave quality inspection
- Verifying core size

Product Dimensions

Length — 186.9 mm [7.359 in.]
Width — 51.6 mm [2.030 in.]
Height — 31.5 mm [1.240 in.]
Weight — 317.5 g [0.70 lb.]

Description		Part Number
Hand Held Microscope		1754767-1
Adapters	1.25 mm Universal LC and MU	1754765-1
	2.5 mm Universal SC, ST and FC	1754766-1
	SC APC	1828833-1
	MT-RJ	1754768-1
	MPO	1828836-1
	MPO APC	1828837-1
	LIGHTRAY MPX Connectors	1828834-1
	LIGHTRAY MPX APC Connectors	1828835-1
	FSMA	1985040-1*

* Coupling adapter Part Number 1985041-1 required.

DANGER: Active fibers should never be viewed through a microscope.

Note: All part numbers are RoHS compliant.

Tooling (Continued)

MTP/MPO IBC Cleaner
Part Number 1918809-1

Product Facts

- Cleans male or female MTP/MPO connectors
- Pre-washed cleaning cloth is lint and debris free
- Each cleaner is capable of more than 400 cleanings
- Can be used for bulkhead and unmated MTP/MPO cleaning
- Protective dust cover doubles as an adapter cap for cleaning unmated connectors
- FOCIS 5-Type MTP/MPO interface compliant
- Removes dust and oil contamination
- Ideal solution for cleaning parallel optics transceivers

MTP is a trademark of US Conec Ltd.



The MTP/MPO IBC (In Bulkhead Cleaner) dry cloth cleaner offered by Tyco Electronics utilizes a densely woven micro-fiber cloth that cleans male (with pins) or female MTP/MPO connectors while in adapters, bulkheads, faceplates, or in unmated form with the unique adapter/dust cover. The unique cleaning cloth also reduces static charge

making it one of the most advanced cleaning systems available for bulkhead optical connector cleaning.

Applications

For effective cleaning of:

- Male and female MTP/MPO connectors inside mating adapters
- Unmated male and female MTP/MPO connectors using included adapter

- Parallel optics transceivers
- Networking gear including switches and routers
- Factory or field connectors

Product Dimensions

Length — 184.2 mm [7.25 in.]
Width — 56.5 mm [2.22 in.]
Thickness — 22 mm [0.866 in.]
Adapter Length — 19.5 mm [0.759 in.]

OPTIPOP R Reel Cleaner

Product Facts

- Static attraction is minimized
- Ultra clean micro-fiber cloth captures debris and other contamination
- Robust cloth does not fray or leave fibrous material behind
- Reduces the number of field and test issues caused by contaminated end faces
- High-end cost effective cleaning solution



Reel Cleaner Refill (Six per Pack)
Part Number 1918806-1

OPTIPOP is a trademark of NTT Advanced Technology Corporation.



The OPTIPOP R dry cloth cassette cleaners offered by Tyco Electronics utilize a densely woven micro-fiber cloth that cleans fiber optic connector tips while reducing static charge. This makes them one of the most advanced cleaning systems available for optical connector cleaning.

Applications

A variety of reel cleaner configurations allow for use on the major optical connector types including FC, SC, ST, LC, MU, ODVA conforming, MT-RJ, and MPO.

Product Dimensions

Length — 127 mm [5.00 in.]
Width — 83 mm [3.26 in.]
Thickness — 48 mm [1.89 in.]
Weight — 150 g [0.33 lb.]

Description	Part Number
MPO w/pins reel cleaner	1918802-1
One slot reel cleaner; 1.25 mm, 2.5 mm, MT No Pins	1918803-1
MT-RJ connector w/pins reel cleaner	1918804-1
Two slot reel cleaner; 1.25 mm and 2.5 mm	1918805-1
Reel cleaner refill (six per pack)	1918806-1

Note: All part numbers are RoHS compliant.

Tooling (Continued)

OPTIPOP C Card Cleaner

Product Facts

- Static attraction is minimized
- Ultra clean micro-fiber cloth captures debris and other contamination
- Robust cloth does not fray or leave fibrous material behind
- Reduces the number of field and test issues caused by contaminated end faces
- Compact size



Card Cleaner Refill (Ten per Pack)
Part Number 1918811-1

The compact OPTIPOP C dry cloth card cleaner offered by Tyco Electronics utilizes a densely woven micro-fiber cloth that cleans fiber optic connector tips while reducing static charge. This makes it one of the most advanced cleaning systems available for optical connector cleaning.

Applications

The card cleaner can be used on major optical connector types including FC compliant, SC, ST, LC, MU, LC, ODVA, MT-RJ*, and MPO*.

*Without guide pins installed.

Product Dimensions

- Length** — 120 mm [4.72 in.]
- Width** — 57 mm [2.24 in.]
- Thickness** — 16 mm [0.63 in.]
- Weight** — 60 g [0.13 lb.]

OPTIPOP is a trademark of NTT Advanced Technology Corporation.

Description	Part Number
Fiber connector card cleaner	1918810-1
Card cleaner refill (ten per pack)	1918811-1

NEOCLEAN Stick Cleaner

Product Facts

- Perforated handle for customizing length and angle
- Ultra clean micro-fiber cloth captures debris and other contamination while minimizing static attraction
- Robust cloth does not fray or leave fibrous material behind
- Reduces the number of field and test issues caused by contaminated end faces
- Convenient packaging

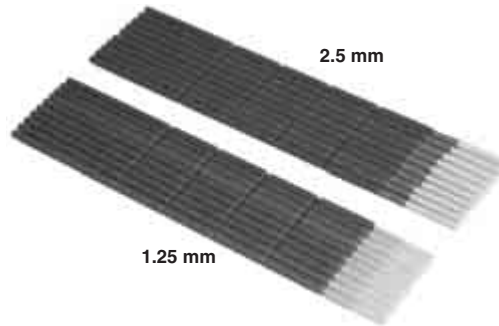

The NEOCLEAN dry cloth stick cleaners offered by Tyco Electronics utilize a densely woven micro-fiber cloth that cleans fiber optic connector tips while reducing static charge. This makes them one of the most advanced cleaning systems available for bulkhead optical connector cleaning.

Applications

The stick cleaners can be used on major single fiber optical connector types inside bulkhead adapters including FC compliant, SC, ST, LC, MU, LC ODVA, and MT-RJ Jacks in addition to transceivers and lenses.

Product Dimensions

- Part Number 1918807-1**
2.5 mm Stick Cleaner
Overall Length — 151.2 mm [5.95 in.]
Tip Diameter — 1.25 mm [0.049 in.]
Handle Diameter — 2.65 mm [0.104 in.]
Tip Length — 12.6 mm [0.496 in.]

- Part Number 1918808-1**
1.25 mm Stick Cleaner
Overall Length — 151.2 mm [5.95 in.]
Tip Diameter — 2.5 mm [0.098 in.]
Handle Diameter — 2.65 mm [0.104 in.]
Tip Length — 20.0 mm [0.787 in.]

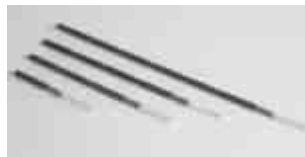

NEOCLEAN is a trademark of NTT Advanced Technology Corporation.

Note: All part numbers are RoHS compliant.

Tooling (Continued)

Hand Tools



PRO-CRIMPER III Hand Tool
Part Number 2064431-1

Instruction Sheet
408-4020
<http://www.tycoelectronics.com/documents>

PRO-CRIMPER III Hand Tool

Connector	Cable Jacket Diameter (mm)	Part Number	
		Hand Tool w/ Die Set	Die Set Only
FSMA	3.0	58551-1	58552-1 (hex die)
ST Ceramic	3.0	58433-4	58424-1
ST Stainless Steel	3.0	58433-4	58424-1
ST Polymer Composite	3.0	58433-4	58424-1
ST Ceramic Used with Loose Tube	3.8	—	503890-1
ST Stainless Steel (504XXX series only)	3.0	58551-1	58552-1
SC/FC (Polymer crimp body)	3.0	503911-1	503910-1
	2.4 & 3.0	492026-1	492025-1
SC/FC (Metal crimp body)	3.0	—	492131-1
LIGHTCRIMP Plus and LIGHTCRIMP ST	3.0	492623-1	492622-1
LIGHTCRIMP Plus and LIGHTCRIMP SC	3.0	492782-1	492783-1
LIGHTCRIMP Plus LC	1.6 – 2.0	1754137-1	1754136-1
MT-RJ SECURE Connector	1.8	1278632-1	1278627-1
LC	3.0, 2-4, 1.6-2.0	1588176-1	1588175-1

Polishing Bushing, Curing Sleeves and Strip Card Kits

Connector	Cable Jacket Diameter (mm)	Part Number		
		Polishing Bushing	Curing Sleeves/Pieces	Strip Card Kit
FSMA	3.0	228025-1	502249-1 (12 pcs.)	501818-1
ST				
Ceramic, Stainless Steel	3.0	503337-1 (Metal) 503304-1 (Black Polymer)	502259-1 (12 pcs.)	501818-1
Polymer Composite	3.0	503304-2 (Beige Polymer)	502259-1 (12 pcs.)	501818-1
FC	3.0	504862-1	502862-2 (6 pcs.)	1754636-1
SC	3.0	502631-1 (Black Polymer)	502656-1 (1 pc.)	1754636-1
LC		1754074-1 (Metal)	1457630-X ¹ (12 pcs.)	1588756-1

¹ -1 LC 900 μm
-2 LC jacketed cable

Note: All part numbers are RoHS compliant.

Table of Contents

Section 3 — Fiber Management & Capabilities 57-62

Fiber Management Systems 58

LIGHTRAY OFX Optical Fiber Circuit Assemblies 59

On Card Fiber Management 60

Enclosures and Customer Interface Panels 61

Laser Process for Fibershape Products 62

Fiber Management Systems

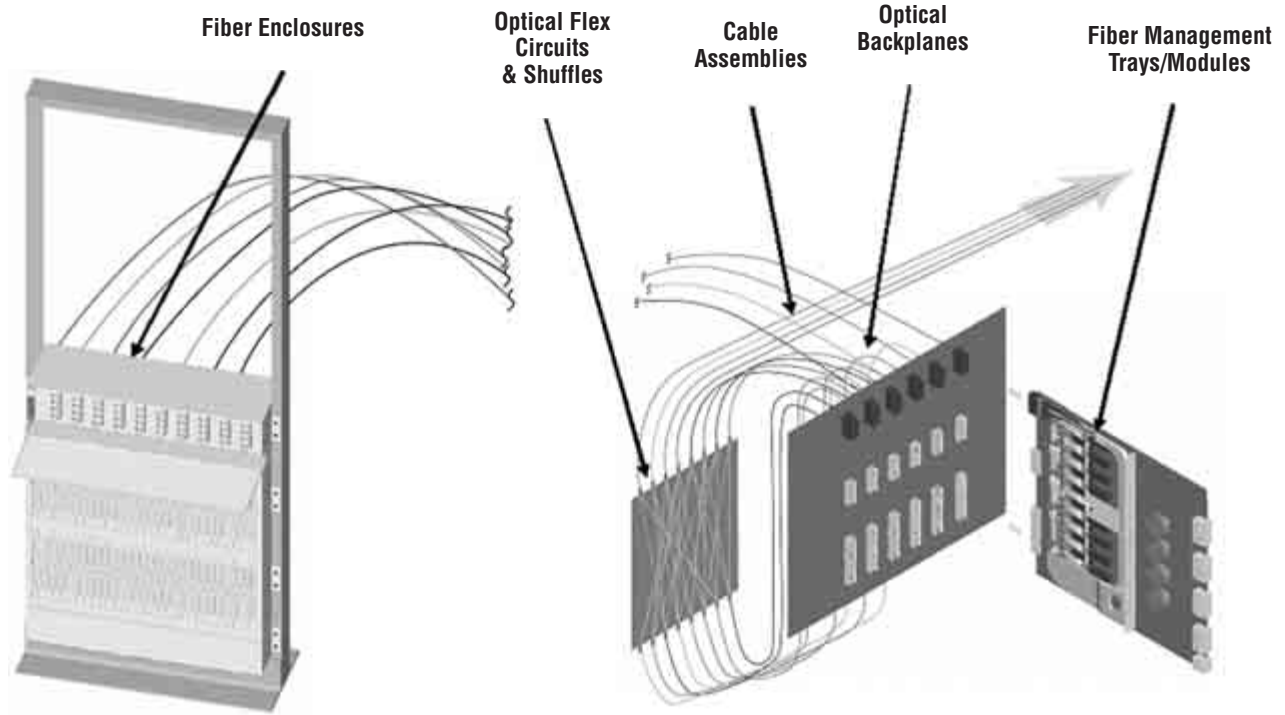

Tyco Electronics is recognized globally as a leader in Fiber Optics Interconnects. We also offer a complete line of integrated Packaged Solutions to meet most complex design challenges. Working directly with us, our designers can offer solutions that help reduce your time to market, simplify your manufacturing, and work with you so that your design requirements are met. We offer complete solutions to a variety of fiber management challenges.

The products in this Fiber Management and Packaged Solutions section are custom designed products, specific to our customers' applications. Please contact your local Tyco Electronics' Sales Representative for design assistance.

LIGHTRAY OFX Optical Fiber Circuit Assemblies

Product Facts

- Singlemode and multimode product range
- Available in a range of symmetrical and asymmetrical designs
- Can be designed with a choice of protective film substrates (including V0 rated materials)
- Pre-terminated with LIGHTRAY MPX Connector or any other industry standard connector
- Operates over a broad temperature range
- Fiber optic equivalent of a copper circuit
- Allows fiber “crossovers” without performance penalty
- Very low insertion loss
- Flat or cylindrical design

Benefits

- Easy routing and management of thousands of fibers on a single substrate
- Fully optical cross connect
- Lightweight
- Saves valuable space
- Significantly contributes to skew compensation
- Easy to install
- Offers flexibility in systems design

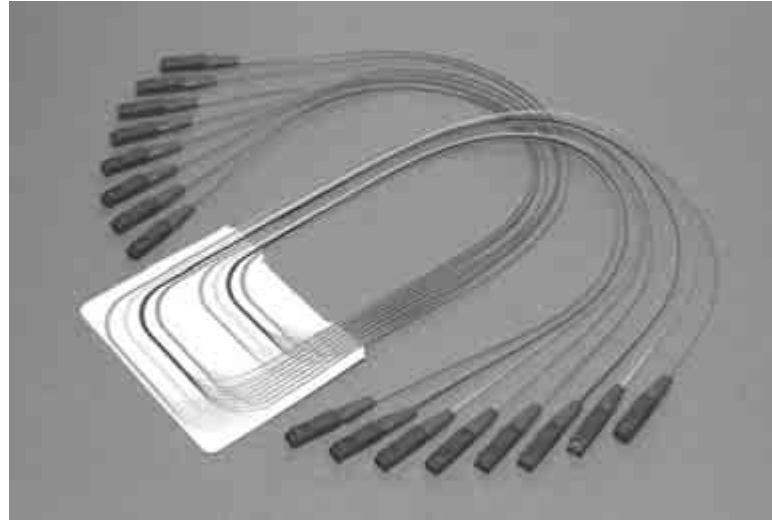

Tyco Electronics' LIGHTRAY OFX optical fiber circuit offers an innovative and flexible solution to precision fiber management in high fiber count applications.

Designed using the latest fiber optic technology, the LIGHTRAY OFX optical

circuit consists of a number of optical fibers, which are encapsulated in thin protective film substrates. As well as saving valuable space in equipment and equipment racks, the LIGHTRAY OFX circuit also provides optimum optical performance.

Optical fiber “crossovers” allow the optical fibers to be routed in both regular and irregular designs. Fibers are routed on 250 μm center lines allowing LIGHTRAY MPX connectors to be terminated on the fiber tails.

Key Applications

High Fiber Count Applications in Optical Transmission and Switching Equipment, in Equipment Racks or on the Printed Circuit Board.

- Provides a complete optical backplane, interconnecting multiple daughtercards
- Complex rack harnesses
- Simplified intra-rack fiber management and cabling
- Serves as a complete optical cross connect (64 x 64 or 128 x 128) in less than 500 x 500 mm of valuable space
- Can be used for the interconnection of optoelectronic devices on the printed circuit board

Optical Performance (singlemode)

Maximum Insertion Loss* (connector loss) — <0.1 dB max; <0.05 dB typical

Polarization Depending Loss — <0.1 dB

Mechanical Characteristics
Vibration (per IEC 61300-2-1) — 10-55Hz

Fiber Retention (per IEC 61300-2-4) — 44 N max.

Environmental Characteristics

Operating Temperature — -40°C to +85°C

Storage Temperature — -40°C to +85°C

Humidity — 95%

* final loss depending on connector types

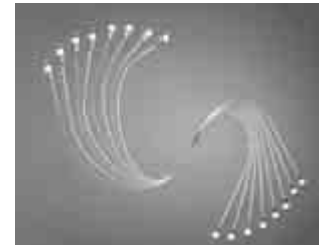

On Card Fiber Management

Product Facts

- Multimode or Singlemode
- Custom design
- 94-V0 rated materials

Benefits

- Easy management of on-board fibers
- Fiber protection and routing (allowing use of 250 micron fiber for added density)
- Pre-loaded and tested trays to facilitate manufacturing
- “Mezzanine” trays allow components to be mounted underneath the fiber tray — minimizing board real estate
- Splice management
- Maintaining minimum bend radius
- Eliminating long term performance degradation through “sag”
- Skew control

Before

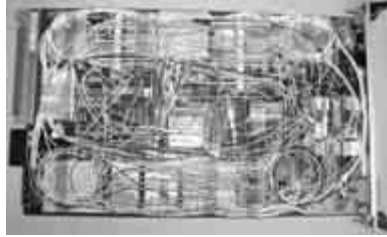

After

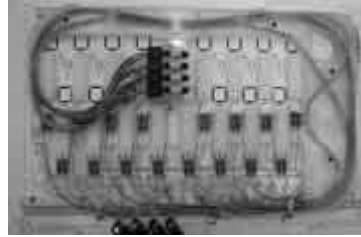

Thin modules designed to fit on your system card.

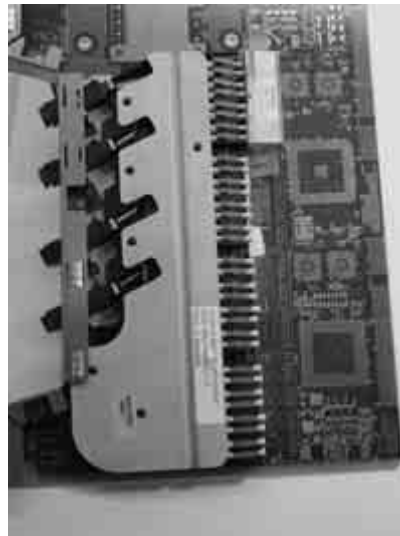

Plug and play — drop the module on your board and plug the connectors.



Non-planar circuits

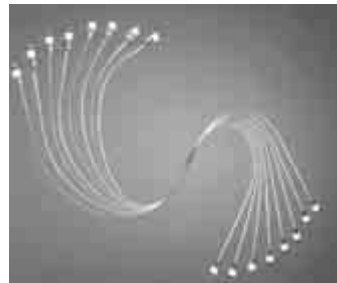

Enclosures and Customer Interface Panels

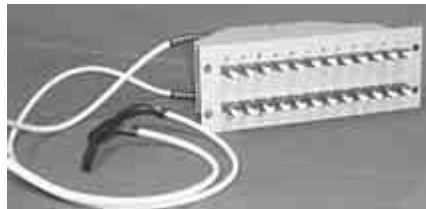
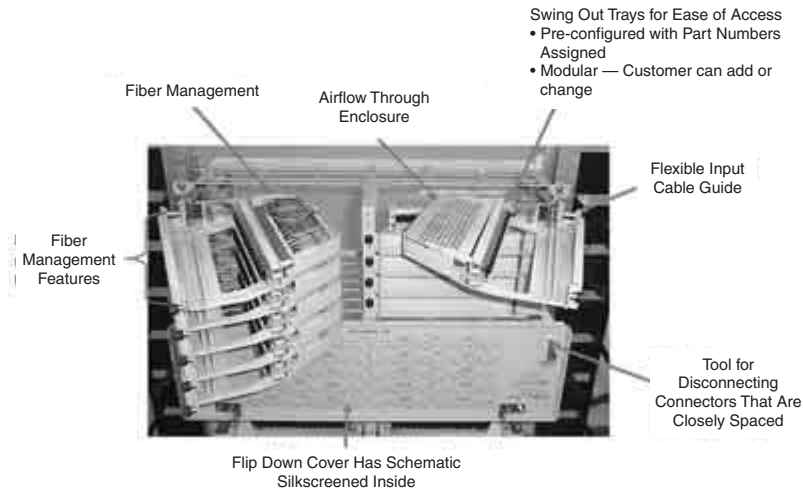

Tray is
Preloaded
and Tested



SFF (LC, MU, MT-RJ)

As customer interface panels and enclosures increase in fiber count and density, issues of fiber management, reparability, and scalability become increasingly complex. We offer complete solutions matched to the customers' individual program needs:

- High density, ease of access, flexibility
- Pre-loaded and tested cables
- Modular design approach for flexibility in I/O's needed, cable dress, and connector styles
- Accommodate airflow needs
- EMI Solutions

Laser Process for Fibershape Products

Fibershape Products by Laser Processing

Product Facts

- Complete range of cleave angles
- Ultra high precision measured @ core region (± 0.5 degrees)
- Capable of providing domed end finish
- Angle cleaving of ribbons (incl. sawtooth)
- Angled cleaves in 0, 8, 45 and other custom degrees
- Ultra precise length control of cleaved endface versus ref. plane
- Capable of cleaving close to fiber coating
- High volume industrial solution for the opto-electronic industry

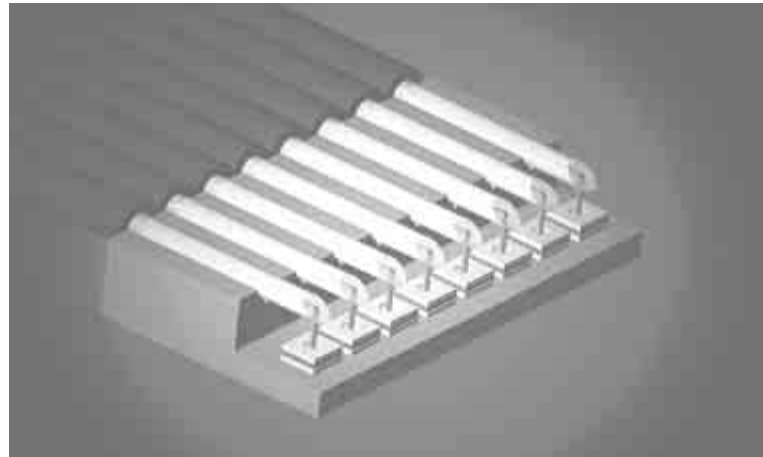

90 Degree VCSEL Array Interface

Tyco Electronics laser process, which uses the power of a laser beam to prepare fiber endfaces for termination in connector assemblies and optical devices, provides a state-of-the-art solution for opto electronic device pigtailing including:

- Planar OEICs
- Array Devices
- Discrete Laser/LED/Receiver package
- Detachable pigtails

This ultra high precision process enables very compact designs and perpendicular fiber coupling.

Please contact your local sales representative or Tyco Electronics for more in-depth product information.

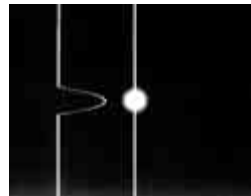

Near Field Scan @ 1310 nm

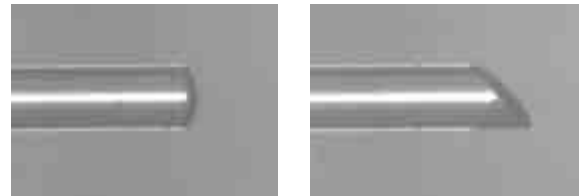

Straight and Angled Cleave

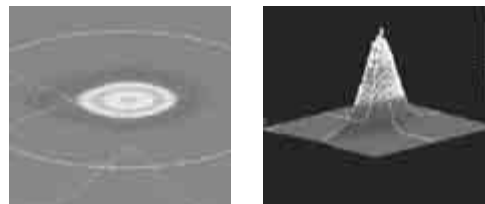

Wedge Fiber Characteristics



Laser Processed Subassembly

Table of Contents

Section 4 — Other Products and Capabilities 63-70

AMP NETCONNECT Premises Wiring Products..... 64

Telecom Outside Plant Products 65

Attenuators 66-69

Switches 70

AMP NETCONNECT Premises Wiring Products

Premises Wiring Products



Optical Fiber Connectivity: LC SECURE Connectors, MPO SECURE Connectors, and MT-RJ SECURE Connectors



No Epoxy, No Polish Terminations (SC, LC, MT-RJ and ST)



MPO High-Density Fiber Connectivity, Cables and Cassettes



AMPTRAC Connectivity Management System



Complete Product Line for Fiber Networking



25 Year System Warranty

The AMP NETCONNECT Business Unit of Tyco Electronics offers a total fiber optic solution including fiber optic cable, connectivity and hardware; as well as network management through the new AMPTRAC Connectivity Management System. Please contact the AMP NETCONNECT business unit for more informa-

tion on product and system warranties.

Additionally, the AMP NETCONNECT Business Unit offers a complete line of copper networking products, including shielded and unshielded twisted pair cabling solutions, cables, connectivity, cable assemblies, patch panels and faceplates.

For more information on any Premises Wiring products or systems, visit www.ampnetconnect.com or contact customer service at 1-800-553-0938.

The AMP NETCONNECT full line catalog (#82164) is also available through customer services or from your local Tyco Electronics sales representative.

Telecom Outside Plant Products

**Telecom Outside Plant
Products**

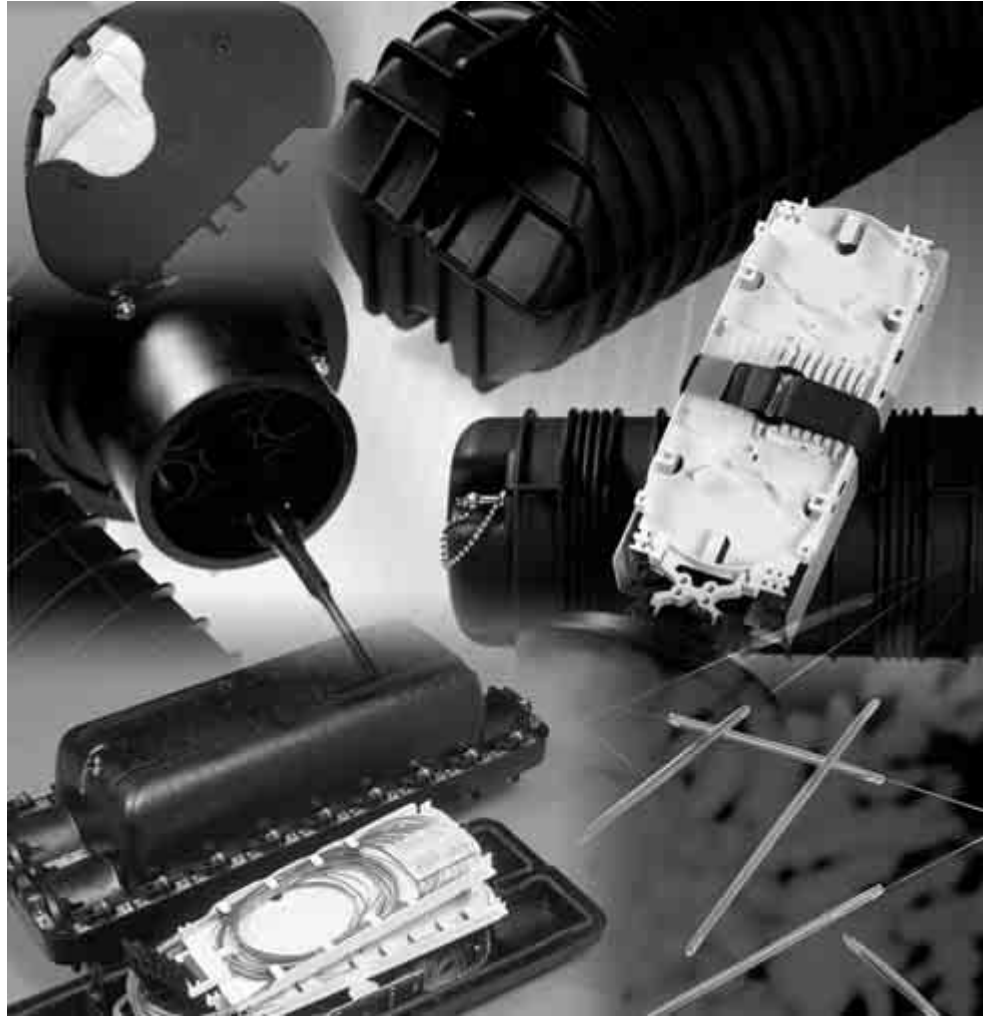

The Telecom Outside Plant Business Unit of Tyco Electronics has been created from a family of companies with a long tradition of making quality components for telecommunications networks and providing innovative solutions for their evolving needs.

The FIST, FOSS, and FibrBoss families of modular fiber management products enhance the design, implementation, and maintenance of fiberoptic networks, from the central

office/exchange to the customer's premises.

For more information on Telecom Outside Plant products or services, visit <http://www.telecomosp.com> or contact customer service at 1-888-557-8901.

A full line Telecom Outside Plant Catalog (#1654451) is also available through customer services or your local Tyco Electronics sales representative.

Attenuators

Singlemode Build Out Attenuators

Product Facts

- A range of fixed attenuation values. Standard values of 1 through 20 and 25 dB
- LC, SC, FC, ST, and D4 styles
- Attenuation is wavelength independent and polarization insensitive
- Low PDL
- Low modal noise
- Vibration resistant
- Dual Window and Broadband Bandpass
- End face geometry per GR-326
- Designed to comply with Telcordia GR-910

Applications

- Power leveling in DWDM transmission systems
- Test and Measurement
- Power attenuation at the receiver

Available Collateral

- Test reports qualifying product to Telcordia GR-910 (2004)
- Application Specification 114-1129
- Installation/Cleaning Instruction Sheet 408-8895
- Product Specification 108-2099

<http://www.tycoelectronics.com/documents>

- Customer Drawings



Customizable Features

- Attenuation tolerance
- Attenuation values in 1 dB increments
- Labeling
- Kitting/Packaging
- Wavelength Dependent Loss
- Reflectance:
 - UPC to -55 dB max.
 - APC to -65 dB max.

Specifications

- Attenuation Values** — 1-20 dB and 25 dB (Fixed)
- Reflectance** — ≤ -55 and -65 dB for UPC and APC polish, respectively
- Operating Temperature** — -40°C to +75°C
- Vibration Resistance** — < 0.1 x attenuation

Attenuators (Continued)

Singlemode LC Attenuators, Build Out Style, Fixed Value

LC/UPC

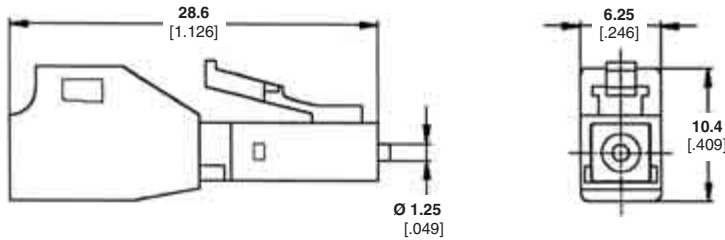

Note: Additional attenuation values available upon request.

Broadband Bandpass Attenuators Operating Wavelength 1260-1360 nm & 1430-1625 nm

Attenuation (dB)	Part Number
1	1693560-1
2	1693560-2
3	1693560-3
4	1693560-4
5	1693560-5
6	1693560-6
7	1693560-7
8	1693560-8
9	1693560-9
10	1-1693560-0
11	1-1693560-1
12	1-1693560-2
13	1-1693560-3
14	1-1693560-4
15	1-1693560-5
16	1-1693560-6
17	1-1693560-7
18	1-1693560-8
19	1-1693560-9
20	2-1693560-0
25	2-1693560-5

Note: Attenuation Tolerance, Ambient
 ≥ 5 dB: ± .10 x nominal attenuation value
 < 5 dB: ± 0.50 dB
 Reflectance ≤ -55 dB

Singlemode SC Attenuators, Build Out Style, Fixed Value

SC/UPC

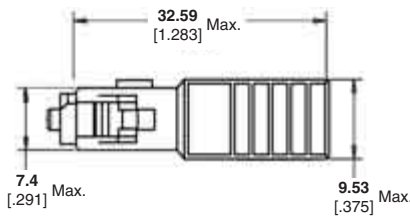

Note: Additional attenuation values available upon request.

Dual Window Attenuators Operating Wavelength 1310/1550 nm ±25 nm

Attenuation (dB)	Part Number
1	5209943-1
2	5209943-2
3	5209943-3
4	5209943-4
5	5209943-5
6	5209943-6
7	5209943-7
8	5209943-8
9	5209943-9
10	1-5209943-0
11	1-5209943-1
12	1-5209943-2
13	1-5209943-3
14	1-5209943-4
15	1-5209943-5
16	1-5209943-6
17	1-5209943-7
18	1-5209943-8
19	1-5209943-9
20	2-5209943-0
25	2-5209943-5

Note: Attenuation Tolerance, Ambient
 ≥ 5 dB: ± .10 x nominal attenuation value
 < 5 dB: ± 0.50 dB
 0 dB: 0.50 dB max
 Reflectance ≤ -55 dB

Broadband Bandpass Attenuators Operating Wavelength 1260-1360 nm & 1430-1625 nm

Attenuation (dB)	Part Number
1	5209250-1
2	5209250-2
3	5209250-3
4	5209250-4
5	5209250-5
6	5209250-6
7	5209250-7
8	5209250-8
9	5209250-9
10	1-5209250-0
11	1-5209250-1
12	1-5209250-2
13	1-5209250-3
14	1-5209250-4
15	1-5209250-5
16	1-5209250-6
17	1-5209250-7
18	1-5209250-8
19	1-5209250-9
20	2-5209250-0
25	2-5209250-5

Note: Attenuation Tolerance, Ambient
 ≥ 5 dB: ± .10 x nominal attenuation value
 < 5 dB: ± 0.50 dB
 0 dB: 0.50 dB max.
 Reflectance ≤ -55 dB

Note: All part numbers are RoHS compliant.

Attenuators (Continued)

**Singlemode
SC Attenuators, Build Out
Style Fixed Value**

SC/APC 8°

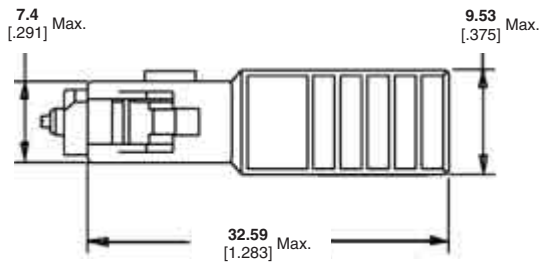

Note: Additional attenuation values available upon request.

* 9° APC Available (Part Number 5417496-X)

**Dual Window Attenuators
Operating Wavelength
1310/1550 nm ±25 nm**

Attenuation (dB)	Part Number
1	5209597-1
2	5209597-2
3	5209597-3
4	5209597-4
5	5209597-5
6	5209597-6
7	5209597-7
8	5209597-8
9	5209597-9
10	1-5209597-0
11	1-5209597-1
12	1-5209597-2
13	1-5209597-3
14	1-5209597-4
15	1-5209597-5
16	1-5209597-6
17	1-5209597-7
18	1-5209597-8
20	2-5209597-0
25	2-5209597-5

Note: Attenuation Tolerance, Ambient
 ≥ 5 dB: ± .10 x nominal attenuation value
 < 5 dB: ± 0.50 dB
 Reflectance ≤ -60 dB

**Broadband Bandpass Attenuators
Operating Wavelength
1260-1360 nm & 1430-1625 nm**

Attenuation (dB)	Part Number
1	5417021-1
2	5417021-2
3	5417021-3
4	5417021-4
5	5417021-5
6	5417021-6
7	5417021-7
8	5417021-8
9	5417021-9
10	1-5417021-0
11	1-5417021-1
12	1-5417021-2
13	1-5417021-3
14	1-5417021-4
15	1-5417021-5
16	1-5417021-6
17	1-5417021-7
18	1-5417021-8
19	1-5417021-9
20	2-5417021-0
25	2-5417021-5

Note: Attenuation Tolerance, Ambient
 ≥ 5 dB: ± .10 x nominal attenuation value
 < 5 dB: ± 0.50 dB
 Reflectance ≤ -65 dB

**Singlemode
FC Attenuators, Build Out
Style, Fixed Value**

FC/UPC

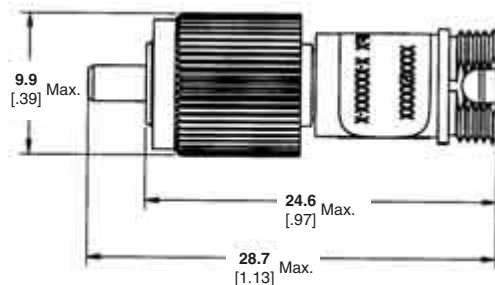

Note: Additional attenuation values available upon request.

**Dual Window Attenuators
Operating Wavelength
1310/1550 nm ±25 nm**

Attenuation (dB)	Part Number
1	5209948-1
2	5209948-2
3	5209948-3
4	5209948-4
5	5209948-5
6	5209948-6
7	5209948-7
8	5209948-8
9	5209948-9
10	1-5209948-0
11	1-5209948-1
12	1-5209948-2
13	1-5209948-3
14	1-5209948-4
15	1-5209948-5
16	1-5209948-6
17	1-5209948-7
18	1-5209948-8
19	1-5209948-9
20	2-5209948-0
25	2-5209948-5

Note: Attenuation Tolerance, Ambient
 ≥ 5 dB: ± .10 x nominal attenuation value
 < 5 dB: ± 0.50 dB
 Reflectance ≤ -55 dB

**Broadband Bandpass Attenuators
Operating Wavelength
1260-1360 nm & 1430-1625 nm**

Attenuation (dB)	Part Number
1	5209285-1
2	5209285-2
3	5209285-3
4	5209285-4
5	5209285-5
6	5209285-6
7	5209285-7
8	5209285-8
9	5209285-9
10	1-5209285-0
11	1-5209285-1
12	1-5209285-2
13	1-5209285-3
14	1-5209285-4
15	1-5209285-5
16	1-5209285-6
17	1-5209285-7
18	1-5209285-8
19	1-5209285-9
20	2-5209285-0
25	2-5209285-5

Note: Attenuation Tolerance, Ambient
 ≥ 5 dB: ± .10 x nominal attenuation value
 < 5 dB: ± 0.50 dB
 0 dB: 0.50 dB max.
 Reflectance ≤ -55 dB

Note: All part numbers are RoHS compliant.

Attenuators (Continued)

**Singlemode
ST Attenuators, Build Out
Style, Fixed Value**

ST/UPC

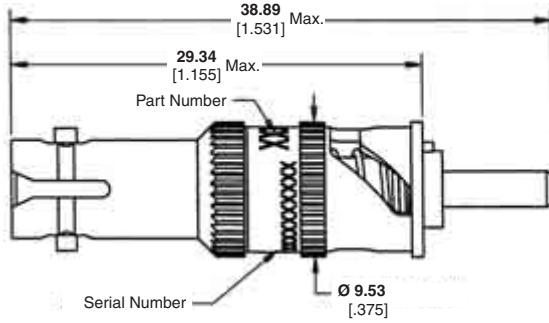

**Dual Window Attenuators
Operating Wavelength
1310/1550 nm ±25 nm**

Attenuation (dB)	Part Number
1	5417549-1
2	5417549-2
3	5417549-3
4	5417549-4
5	5417549-5
6	5417549-6
7	5417549-7
8	5417549-8
9	5417549-9
10	1-5417549-0
11	1-5417549-1
12	1-5417549-2
13	1-5417549-3
14	1-5417549-4
15	1-5417549-5
16	1-5417549-6
17	1-5417549-7
18	1-5417549-8
19	1-5417549-9
20	2-5417549-0
25	2-5417549-5

Note: Attenuation Tolerance, Ambient
 ≥ 5 dB: ± .15 x nominal
 attenuation value
 < 5 dB: ± 0.75 dB
 Reflectance ≤ -55 dB

**Broadband Bandpass Attenuators
Operating Wavelength
1260-1360 nm & 1430-1625 nm**

Attenuation (dB)	Part Number
1	5417399-1
2	5417399-2
3	5417399-3
4	5417399-4
5	5417399-5
6	5417399-6
7	5417399-7
8	5417399-8
9	5417399-9
10	1-5417399-0
11	1-5417399-1
12	1-5417399-2
13	1-5417399-3
14	1-5417399-4
15	1-5417399-5
16	1-5417399-6
17	1-5417399-7
18	1-5417399-8
19	1-5417399-9
20	2-5417399-0
25	2-5417399-5

Note: Attenuation Tolerance, Ambient
 ≥ 5 dB: ± .10 x nominal
 attenuation value
 < 5 dB: ± 0.50 dB
 0 dB: 0.50 dB max.
 Reflectance ≤ -55 dB

**Singlemode
D4 Attenuators, Build Out
Style, Fixed Value**

D4/PC

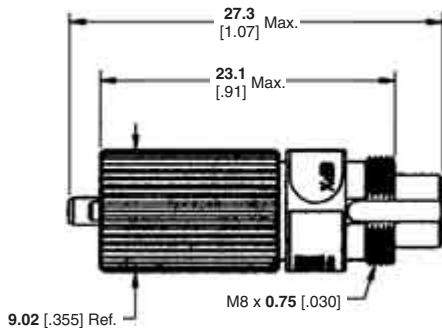

Note: Additional attenuation values
 available upon request.

**Dual Window Attenuators
Operating Wavelength
1310/1550 nm ±25 nm**

Attenuation (dB)	Part Number
5	5209570-5
10	1-5209570-0
15	1-5209570-5
20	2-5209570-0

Note: Attenuation Tolerance, Ambient
 ≥ 5 dB: ± .15 x nominal
 attenuation value
 < 5 dB: ± 0.75 dB
 Reflectance ≤ -45 dB

Note: All part numbers are RoHS compliant.

Switches

Ruggedized Multimode Switches

**Refractive Plate Switch
2 x 2 Bypass Configuration**

**Part Number
6588871-1**

Product Facts:

- No optical path interruption @200 G's for 8 ms
- Successfully passed MIL-S-901D (Navy) Heavyweight Shock Test (Barge Test)
- Fiber type 62.5/125 μ m multimode

Specifications

Operating Temperature Range —
-30° to +85° C

Storage Temperature Range —
-40° to +85° C

Durability —
>1,000,000 cycles

Minimum Actuation Voltage —
4.75 V

Maximum Actuation Voltage —
5.25 V

Actuation Current at Typical —
5.0 V

Actuation Voltage —
100mA (maximum)



Tyco Electronics' Ruggedized Refractive Plate Switch is a multimode optical switch that is capable of withstanding a 200 G shock with a duration of >8ms without interruption of the signal path.

This switch is designed for extreme environments that require absolute product quality on optical installations and optical signal integrity.

Product Dimensions:

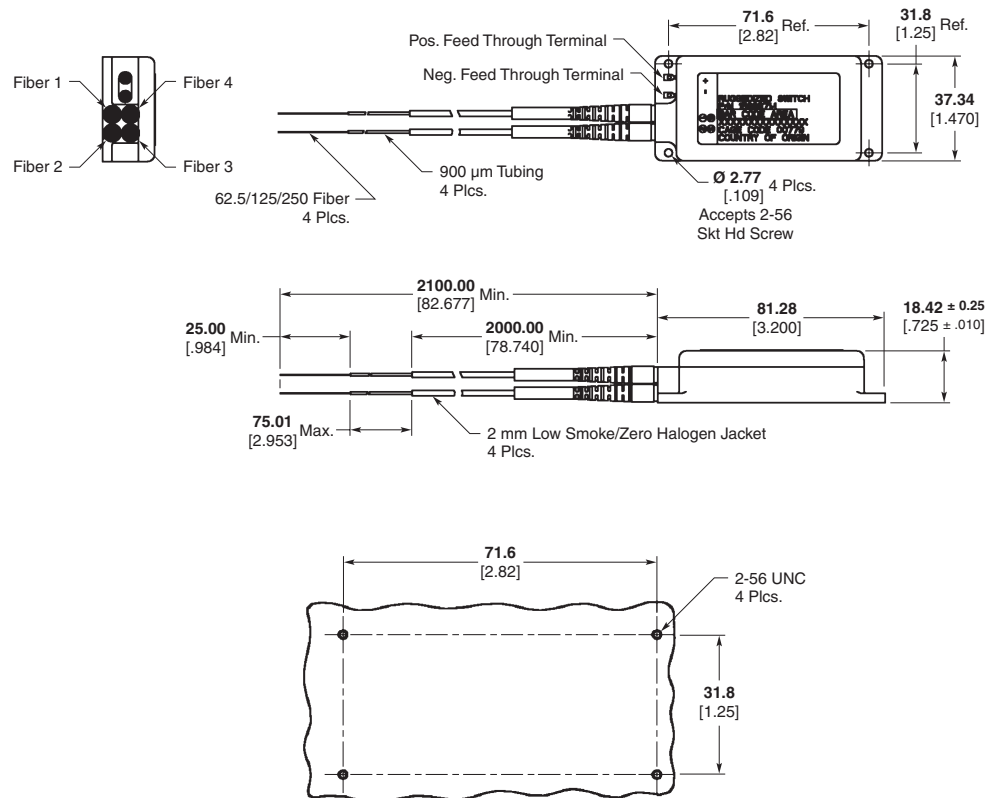

Recommended Mounting Layout

Note: All part numbers are RoHS compliant.

Table of Contents

Section 5 — Fiber to the Antenna Rugged Interconnect	71-96
Introduction	72
FULLAXS Fiber to the Antenna Rugged Interconnect	73
ODC™ Plug and Socket Cable Assemblies	74-78
Max-Travel Fiber to the Antenna Rugged Interconnect	79
LC ODVA Compliant Connectors	80, 81
PRO BEAM Expanded Beam Rugged Optics Products	82-96

ODC is a product and trademark of
HUBER+SUHNER AG.

Fiber to the Antenna Rugged Interconnect



Next generation WiMax and LTE Fiber to the antenna designs require rugged cable assemblies that plug directly into transceivers through a bulkhead.

It has to be a connector design that can accommodate a large tolerance in Z-direction. It has to allow one handed mating (to facilitate installation at the antenna).

With a large Z axis tolerance, they will accommodate the broadest range of transceivers, so end customers can pick the transceiver of their choice.

Applications

- Base Stations
- Industrial
- Aerospace & Defense

FULLAXS Fiber to the Antenna Rugged Interconnect

Product Facts

- Open bulkhead for easy access to SFP
- Positive feedback to operator when fully mated
- One-hand mating
- Duplex LC interface
- Bulkhead cutouts allow for removal of transceiver through the bulkhead (no need to open RRR for transceiver replacement)
- Robust bayonet locking for easy, fast, and secure mating
- Multimode and singlemode
- Water proof, dust proof and corrosion resistant
- Expansion to RJ45, etc
- Plug has tolerance free design, fully free floating in Z-axis
- No Cable buckling at any time during or after installation
- Cost effective glass-filled polymer or metal diecasted bulkhead
- Field installable version available



Specifications

Temperature — -40°C – +85°C

150 N Pull Force — per IEC61300-2-4

Protection Class — IP67

Cycles — 50 Mating Cycles

Vibration — per GR3115 (3.26.3)

Salt Mist — per IEC 61300-2-26

Vibration — per IEC 61300-2-1

Shock — per IEC 61300-2-9

Impact — IEC 61300-2-12

Temperature / Humidity — IEC 61300-2-22

Mechanical

Retention — 150 N cable retention

Rating — IP67 Rated

Interface — LC interface

Adapter Footprint — 36 mm x 36 mm

Locking Style — Bayonet style

Duplex LC Interconnect — MM or SM

Tools — No tools required

Operating Temperature — -40°C to +85°C

Mating Durability — min. 50 cycles

ODC™ Plug and Socket Cable Assemblies

Product Facts

- 2 and 4 Channel
- Multimode — 2 & 4 Ch;
Singlemode — 2 Ch
- Compact design with 2 x or
4 x 1.25 mm ferrules
- Built-in socket available
with square or hexagonal
flange
- Water proof, dust proof and
corrosion resistant
- Screw lock mechanism
- Scoop proof
- One hand, blind-mating
possible
- Attached protection cap
- EMI shielded
- Low-Smoke, Zero-Halogen
(LSZH)



The ODC connectors, together with the support optical cable, are becoming the standard interface specified in 3G, 4G and WiMax Base Station remote radios and Fiber-to-the-Antenna applications.

The ODC cable assembly is based on the N Type RF Coax connector. The prod-

uct, however, is not limited to the above applications. As the ODC cable assemblies have passed tests like salt mist, vibration and shock and meets protection class IP68, they are well suited for Industrial and Aerospace and Defense applications.

Applications

- Base Stations
- Industrial
- Aerospace & Defense

Technical Documents

Protection Class

IP68

Salt Mist

IEC 61300-2-26: passed

Vibration

IEC 61300-2-1: passed

Shock

IEC 61300-2-9: passed

Optical

Insertion loss according to IEC 61300-3-34

Multimode —

Typ. ≤ 0.25 dB

Max. ≤ 0.70 dB

Singlemode —

Typ. ≤ 0.30 dB

Max. ≤ 1.00 dB

Return Loss — Single mode ≥ 45 dB

Mechanical

Technology — Full ceramic ferrule and sleeve

Mechanically Robust —

ODC plug ≤ 800 N tensile load

ODC socket ≤ 30 N tensile load

Installation Torque Force —

min. 1 Nm

max. 2 Nm.

Operating Temperature —

-40°C up to +85°C

Mating Durability —

min. 100 cycles

ODC is a product and trademark of HUBER+SUHNER AG.

ODC™ Plug and Socket Cable Assemblies (Continued)

Interface Dimensions

2-Fiber ODC Plug

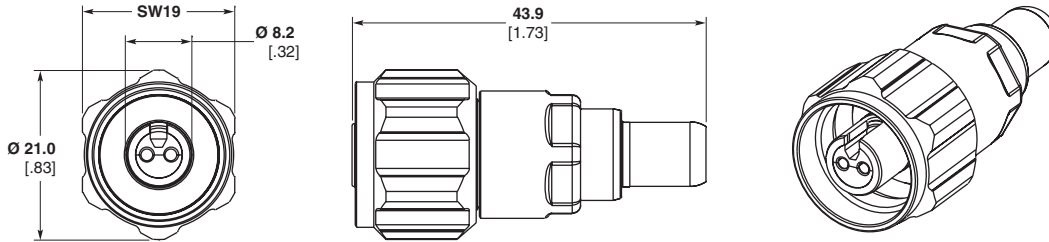

4-Fiber ODC Plug

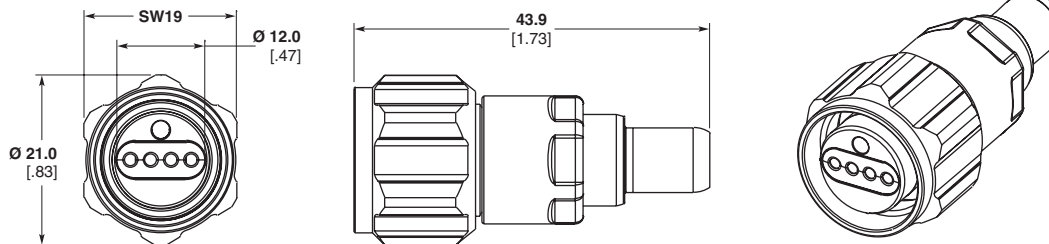

ODC is a product and trademark of HUBER+SUHNER AG.

Catalog 1307895
Revised 4-10

www.tycoelectronics.com

Dimensions are in millimeters and inches unless otherwise specified. Values in brackets are standard equivalents.

Dimensions are shown for reference purposes only. Specifications subject to change.

USA: +1 (800) 522-6752
Canada: +1 (905) 470-4425
Mexico/C. Am.: +52 (0) 55-1106-0814
South America: +55 (0) 11-2103-6000

Germany: +49 (0) 6251-133-1999
UK: +44 (0) 800-267666
France: +33 (0) 1-3420-8686
China: +86 (0) 400-820-6015

ODC™ Plug and Socket Cable Assemblies (Continued)

Interface Dimensions

(Continued)

2-Fiber Small Square ODC Socket

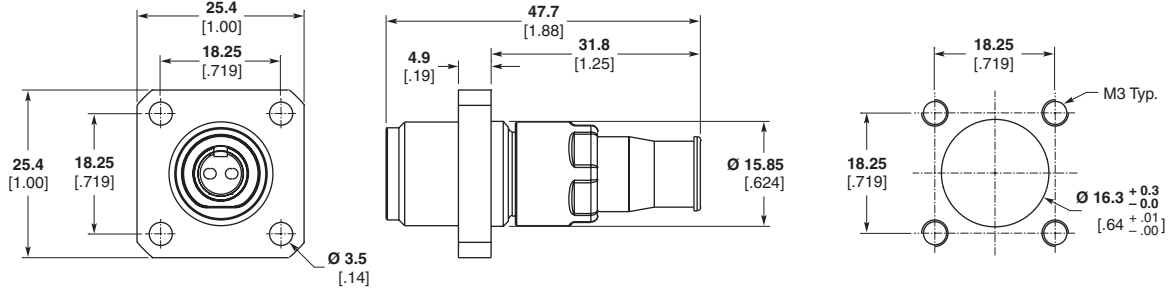

2-Fiber Hexagonal ODC Socket

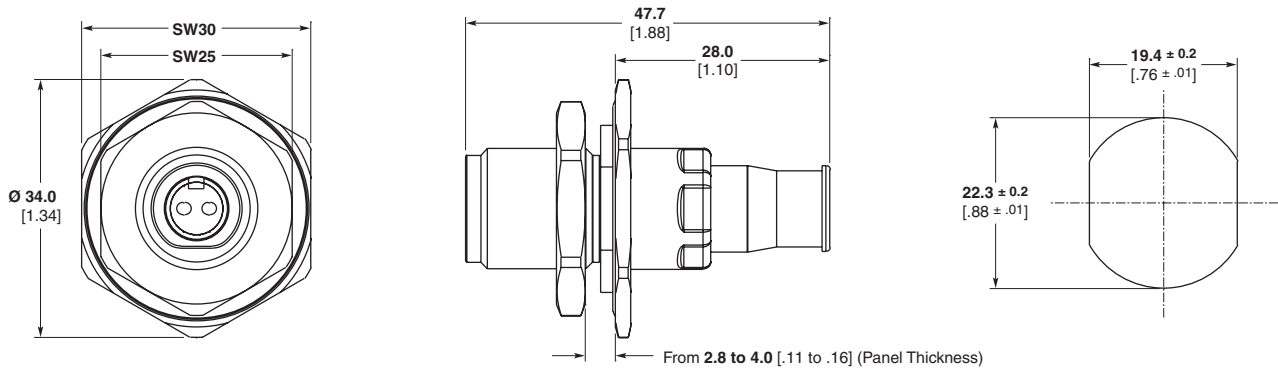

4-Fiber Small Square Socket

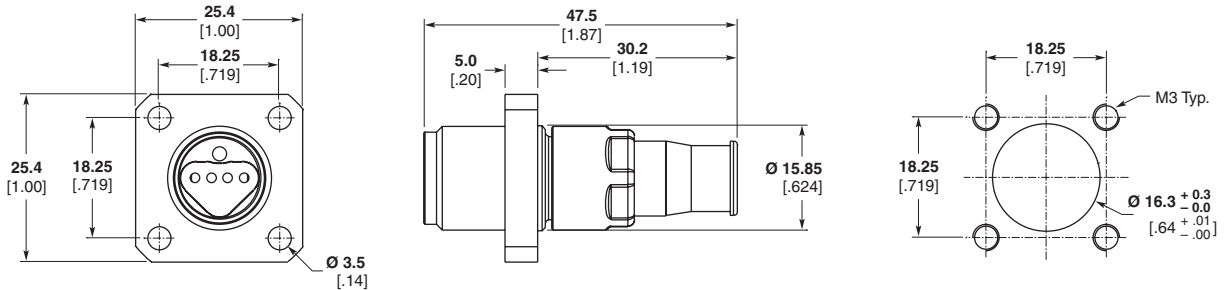

4-Fiber Hexagonal Socket

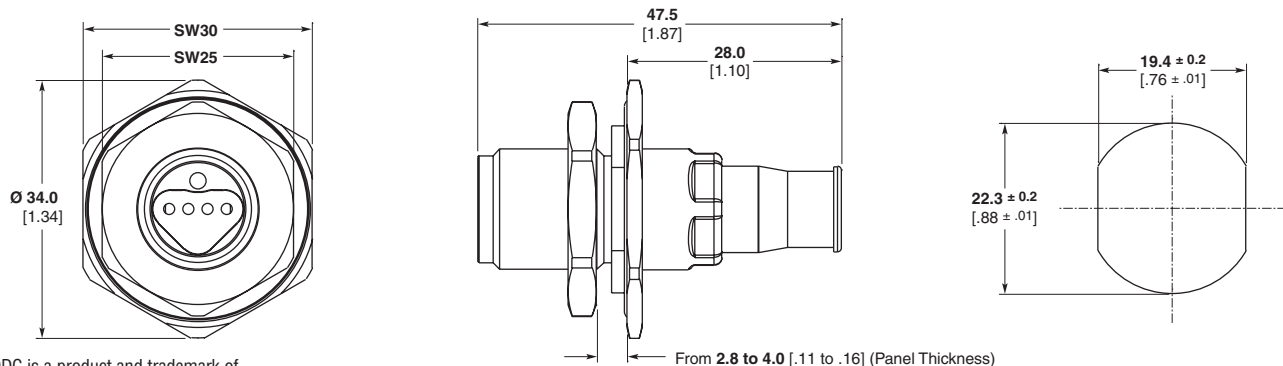

ODC is a product and trademark of HUBER+SUHNER AG.

ODC™ Plug and Socket Cable Assemblies (Continued)

Product Dimensions

2-Fiber Plug to LC Duplex Assembly

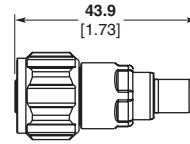
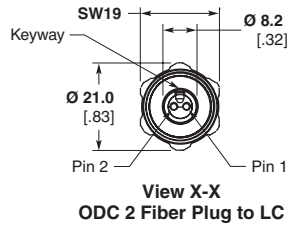

Fiber Path

ODC Plug	LC Connector
Pin 1	↔ A
Pin 2	↔ B

Note: All dimensions are reference dimensions.

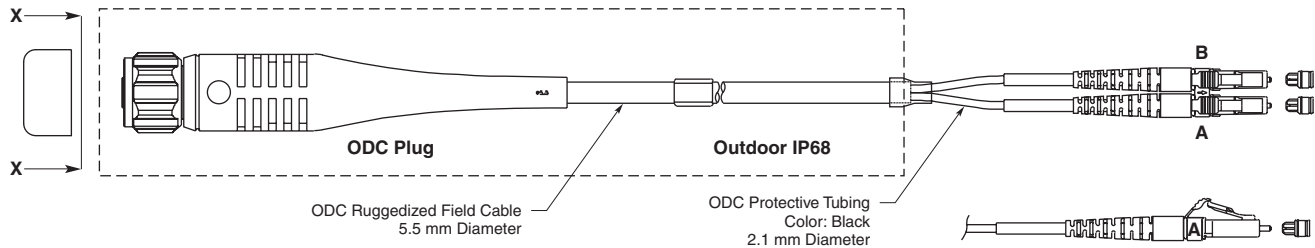

4-Fiber Plug to LC Duplex Assembly

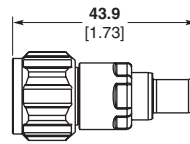
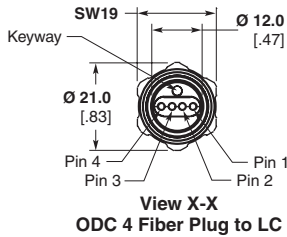

Fiber Path

ODC Plug	LC Connector
Pin 1	↔ 1
Pin 2	↔ 2
Pin 3	↔ 3
Pin 4	↔ 4

Note: All dimensions are reference dimensions.

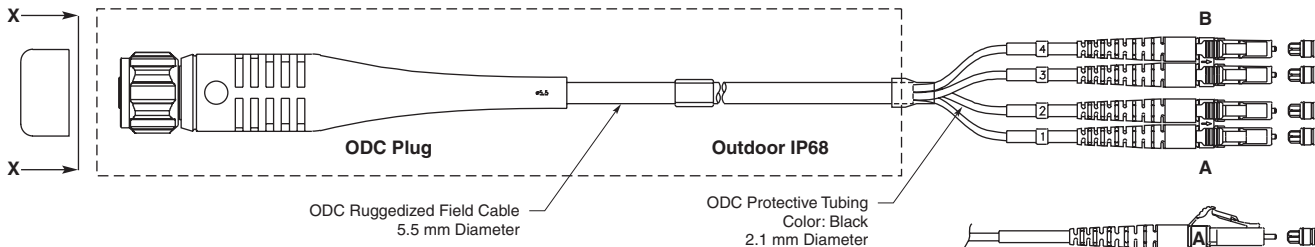

Cable Assembly Part Numbers

Base Part Number ¹	Description	Fiber Size	Available Sizes
1985834	2-Fiber Plug to LC Duplex Assembly	Singlemode	
1985835	2-Fiber Plug to LC Duplex Assembly	Multimode (50/125)	
1985836	2-Fiber Plug to LC Duplex Assembly	Multimode (62.5/125)	1 to 99 meters ²
1985837	4-Fiber Plug to LC Duplex Assembly	Multimode (50/125)	
1985838	4-Fiber Plug to LC Duplex Assembly	Multimode (62.5/125)	
1985844	2-Fiber Plug to LC Duplex Assembly	Singlemode	
1985845	2-Fiber Plug to LC Duplex Assembly	Multimode (50/125)	
1985846	2-Fiber Plug to LC Duplex Assembly	Multimode (62.5/125)	100 to 999 meters ³
1985847	4-Fiber Plug to LC Duplex Assembly	Multimode (50/125)	
1985848	4-Fiber Plug to LC Duplex Assembly	Multimode (65.5/125)	

ODC is a product and trademark of HUBER+SUHNER AG.

Note: All part numbers are RoHS compliant.

- For complete part numbers, obtain proper customer drawing.
 - The length is defined by the dash number (i.e.: 8-1985834-2 is 82 meters long, 1-1985834-5 is 15 meters long)
 - The length is defined by the dash number (i.e.: 8-1985844-2 is 820 meters long, 1-1985844-5 is 150 meters long)
- Note:** Other dust caps (screw type) and connector types, in combination with ODC Plug (or socket), are available upon request.

ODC™ Plug and Socket Cable Assemblies (Continued)

Product Dimensions

(Continued)

2-Fiber Socket to LC Duplex Assembly

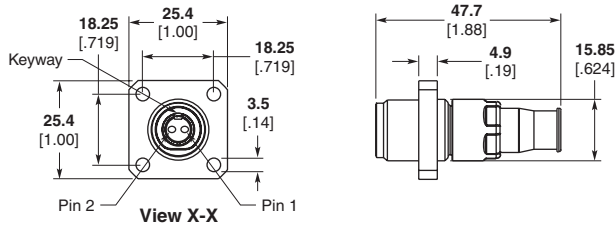

ODC 2 Fiber Socket Small Square to LC

Fiber Path

ODC Socket	LC Connector
Pin 1	↔ A
Pin 2	↔ B

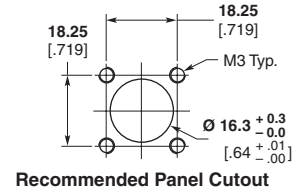

Note: All dimensions are reference dimensions.

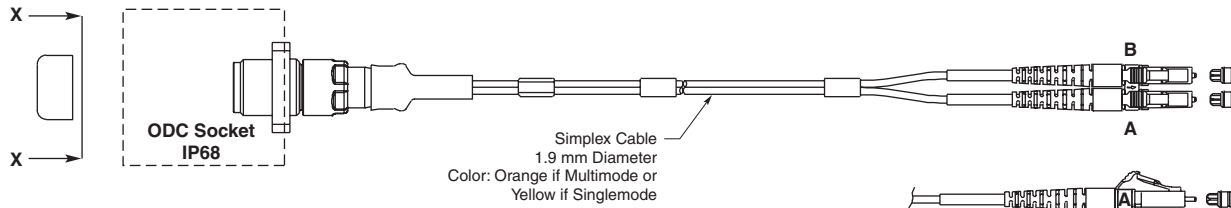

4-Fiber Socket to LC Duplex Assembly

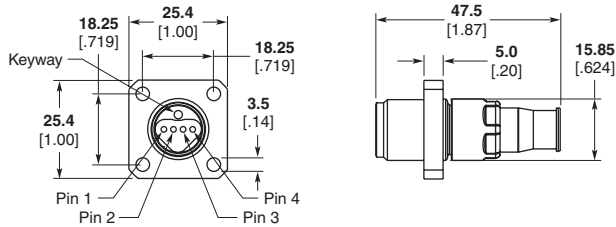

ODC 4 Fiber Socket Small Square to LC

Fiber Path

ODC Socket	LC Connector
Pin 1	↔ 2
Pin 2	↔ 1
Pin 3	↔ 4
Pin 4	↔ 3

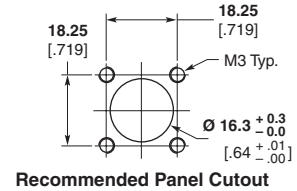

Note: All dimensions are reference dimensions.

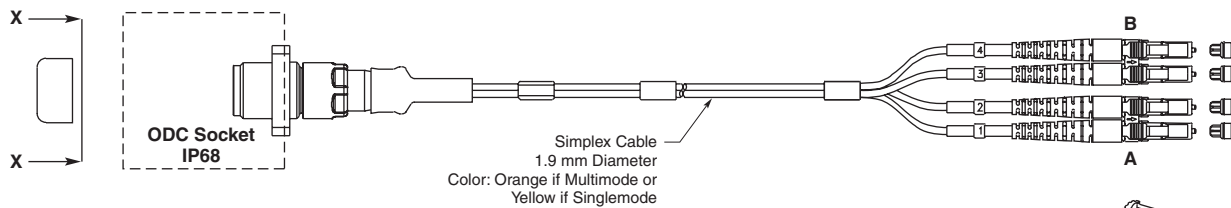

Base Part Number ¹	Description	Fiber Size	Available Sizes
1985839	2-Fiber Socket to LC Duplex Assembly	Singlemode	0.3 to 9.9 meters ²
1985840	2-Fiber Socket to LC Duplex Assembly	Multimode (50/125)	
1985841	2-Fiber Socket to LC Duplex Assembly	Multimode (62.5/125)	
1985842	4-Fiber Socket to LC Duplex Assembly	Multimode (50/125)	
1985843	4-Fiber Socket to LC Duplex Assembly	Multimode (62.5/125)	

1. For complete part numbers, obtain proper customer drawing.
 2. The length is defined by the dash number (i.e.: 3-1985839-5 is 3.5 meters long, 1-1985839-6 is 1.6 meters long)
Note: Other dust caps (screw type) and connector types, in combination with ODC Plug (or socket), are available upon request.

Note: All part numbers are RoHS compliant.

ODC is a product and trademark of HUBER+SUHNER AG.

Max-Travel Fiber to the Antenna Rugged Interconnect

Next generation WiMax and LTE Fiber to the antenna designs require rugged cable assemblies that plug directly into transceivers through a bulkhead.

Max-Travel provides the widest tolerance of transceiver lengths and position, while allowing one handed mating (to facilitate installation at the antenna).

With a Z axis tolerance of 6 mm, it will accommodate the broadest range of transceivers, so end customers can pick the transceiver of their choice.



Product Facts

- **Mates with 6 mm variation in transceiver length (6 mm Z Axis Travel)**
- **One-hand mating**
- **Duplex LC interface**
- **Bulkhead cutouts allow for removal of transceiver through the bulkhead (no need to open RRH for transceiver replacement)**
- **Robust bayonet locking for easy, fast, and secure mating**
- **Multimode and singlemode**
- **Water proof, dust proof and corrosion resistant**

Applications

- **Base Stations**
- **Industrial**
- **Aerospace & Defense**

Specifications

- Temperature** — -40°C - +85°C
- 400 N Pull Force** — per IEC61300-2-4
- Protection Class** — IP67
- Cycles** — 500 Mating Cycles
- Vibration** — per GR3115 (3.26.3)
- Salt Mist** — per IEC 61300-2-26
- Vibration** — per IEC 61300-2-1
- Shock** — per IEC 61300-2-9
- Impact** — IEC 61300-2-12
- Temperature / Humidity** — IEC 61300-2-22

Mechanical

- Retention** — 400 N cable retention
- Rating** — IP67 Rated
- Interface** — LC interface
- Adapter footprint** — 36 mm x 37 mm
- Locking Style** — Bayonet style
- Shell** — Full metal shell for EMI protection
- Duplex LC interconnect** — MM or SM
- Tools** — No tools required
- Operating Temperature** — -40°C to +85°C
- Mating Durability** — min. 100 cycles

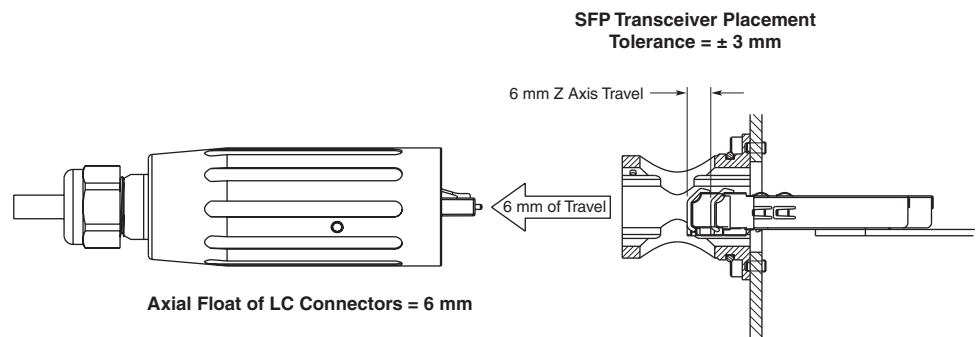

LC ODVA Compliant Connectors

Sealed Circular LC ODVA Compliant Connector

Product Facts

- IP67 rated to ensure protection from dust and water immersion
- LC connector qualified to Telcordia GR-326 and TIA/EIA 568B.3
- Temperature range of -40°C to 85°C
- Bayonet-style mechanical lock
- Flame retardant materials per UL 94 V-0
- Dual mounting bulkhead design
- Singlemode and multimode fiber
- Can be used with cable types 9/125, 50/125 and 62.5/125
- LC to LC internal to the box Jumpers
- LC connector accepts tactical cable with 4.5 mm – 7.5 mm OD
- ODVA Compliant Plug to X interface on tactical with break out
- ODVA Compliant Plug to Plug on tactical cable
- Build to customer need

Applications

The LC ODVA Compliant Connector is ideal for:

- Harsh environments where chemicals, corrosive gases and liquids are commonplace
- Inside and outside industrial plant and equipment that interface with industrial Ethernet networks
- Remote interface applications such as towers and antennae as well as FTTX in PON and at the home applications
- Mobile routers and internet hardware



Plug Part Numbers:
 1828618-1 (Multimode)
 1828618-2 (Singlemode)

Receptacle Part Numbers:
 1828619-1 (Multimode)
 1828619-2 (Singlemode)

Plug & Receptacle Cap Part Numbers:
 Plug Cap 1828740-1
 Receptacle Cap 1918177-1

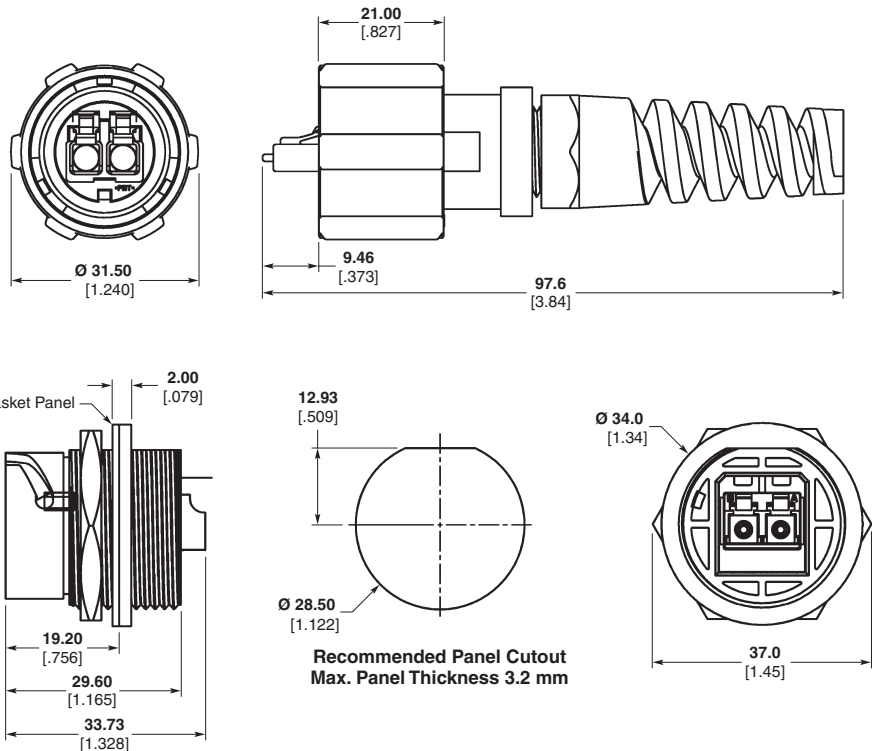

Standard Cable Assemblies

Part Number	Description
1828935-X	LC ODVA Compliant Interface, 62.5, 2 Fiber
1828936-X	LC ODVA Compliant Interface, Singlemode, 2 Fiber

Note: X = length in meters

ASSEMBLY CAPABILITIES

Tyco Electronics has extensive rugged optic harness capabilities. Please consult your local Tyco Electronics Sales Representative for assistance.

Note: All part numbers are RoHS compliant.

LC ODVA Compliant Connectors (Continued)

**Sealed Circular LC
Shielded EMI Connector**

**EMI Shielded Receptacle
Assembly**

- Components are thin film coated using a four-step SS/Cu/Cu/SS vacuum deposition process
- This coating results in an approximate 99% shielding effectiveness over uncoated assemblies

Part Number 1985193-1



Note: All part numbers are RoHS compliant.

PRO BEAM Expanded Beam Rugged Optics Products

Expanded Beam Products

Product Facts

- PRO BEAM Sr., PRO BEAM Jr. and PRO BEAM Mini Connector field deployable interconnects
- ARINC 600 connectors, with inserts/holder blocks designed for Mini Expanded Beam — up to 128 channels on size 3 ARINC 600
- MIL-C-38999 Series III shell size 11 style circular connectors — Cable assemblies up to 4 fibers
- Unique Modular Design, for use with multimode and singlemode fiber
- Tactical cables, cable reels, backpacks
- Cable assembly and termination services
- Ball lens expands cross-sectional area of light over 200 times for multimode and over 2000 times for singlemode
- Rugged hermaphroditic construction (i.e., same insert mates to each other)
- Physically non-contacting mating conditions; no wear, installed fiber ferrule protected by ball lens



From left to right: PRO BEAM Sr., PRO BEAM Jr. & PRO BEAM Mini Expanded Beam inserts.

Fiber Optic Interconnect/Cable System using Expanded Beam technology, which physically expands and collimates the transmission signal into an optical beam over 14 times its original diameter (the cross sectional area of the light beam increases over 200 times for multimode optical signals). For singlemode signals, the collimated beam is over 45 times its original diameter (the cross-

Expanded Beam Technology

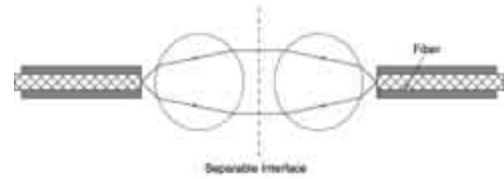

Expanded Beam Principle

sectional area of the light beam increases over 2,000 times.). It is then refocused back down onto the core of the receiving fiber. This approach provides ease of alignment and low sensitivity to thermal changes and contamination. High strength, precision connector housings enhance a durable connection, optimizing low loss and repeatable performance.

Suitable for aerospace, avionics, field-deployable communications, marine ship-to-shore applications, security systems, mobile diagnostic units, oil and gas exploration and other harsh environment applications demanding strength, durability and reliable performance in conditions of multiple coupling/decouplings, blindmate situations, and high vibration.

Product Facts

- No wear on fiber optic interface; Very vibration resistant
- Easy to handle, easy to clean. Durable connection that is highly resistant to dirt/debris
- Singlemode or multimode
- Common 850/1300 Dual Wavelength, 1310, or 1550 nm wavelengths
- Easy alignment for low-loss, repeatable performance
- Consistent overall optical "link budget" assured
- Low sensitivity to thermal fluctuations and interface contamination
- Repeatable low-loss performance in harsh environments

Expanded Beam Inserts

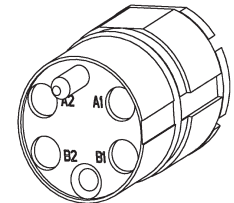

- PRO BEAM Sr. Insert — the original, larger format, Field Tactical, hermaphroditic Connector System
- PRO BEAM Jr. Insert — the second generation, reduced size, Field Tactical Connector System
- Mini Expanded Beam Insert for multi-channel small form factor — the smallest expanded beam multi-channel insert in the industry, a Tyco Electronics exclusive

ASSEMBLY CAPABILITIES

Tyco Electronics has extensive rugged optic harness capabilities. Please consult your local Tyco Electronics Sales Representative for assistance.

PRO BEAM Expanded Beam Rugged Optics Products (Continued)

PRO BEAM Jr. Connectors

Performance Specifications

Optical, Multimode Version

Insertion Loss, Typical —
0.7 dB @ 1300 nm*

Optical, Singlemode Version

Insertion Loss, Typical —
0.7 dB @ 1310 nm or 1500 nm*

Return Loss — > 34 dB @ 1310 nm
or 1550 nm**

*When tested with reference quality
launch/receive cable assemblies

**RL Tested Open Ended

Mechanical

Vibration, Sinusoidal —
10 - 500 Hz, 3 directions;
0.75 mm amplitude @ 10g acceleration

Bump — 4,000 Bumps, 6 directions
@ 50g acceleration

Free Fall — 500 falls on concrete;
Severity 1.2 m

Coupling Endurance —
3,000 couplings

Weight —
Plug — 123 grams, typical
D-Hole bulkhead — 102 grams, typical

Temperature

Operational Temperature —
-40°C/+85°C

Storage Temperature —
-55°C/+85°C

Temperature, Cyclic —
-55°C/+85°C

Humidity (Damp Heat) — 95% RH

Immersion

Water — 15 m depth (plug) -
15 m (Bulkhead)

Material and Finish

Shell Alloy — Aluminum; or nickel
aluminum bronze (high saline environ-
ment)

**Plating (For Aluminum Shells
Only)** — clear hard anodized; or green
chromate conversion zinc (PRO BEAM
Jr. Bulkheads only)

**Bulkhead Connector Panel
Thicknesses**

**PRO BEAM Jr. Bulkhead Connector
D-Hole** — 4 mm max.

**PRO BEAM Jr. Bulkhead Connector
Square Flange** — 6 mm max.

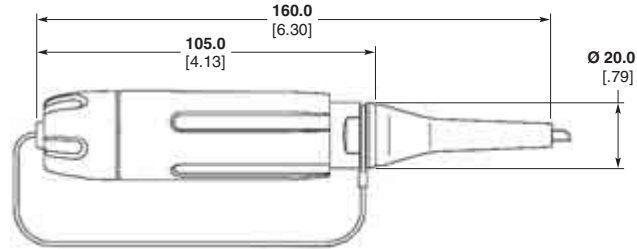

PRO BEAM Jr. Cable Connector, Plug

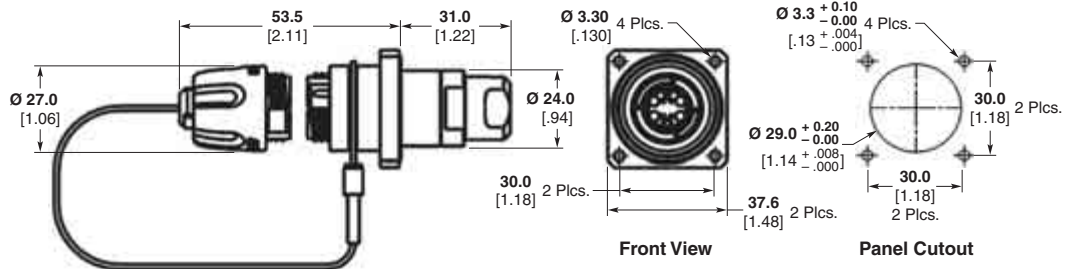

PRO BEAM Jr. Square Flange Mount Bulkhead

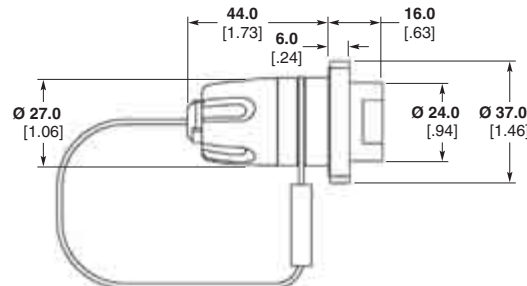

**PRO BEAM Jr. Low Profile,
Square Flange Mount Bulkhead**

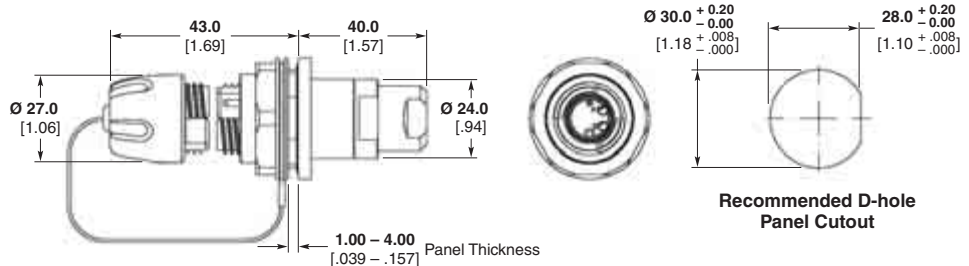

PRO BEAM Jr. D-Hole Bulkhead, Standard Cable Adapter

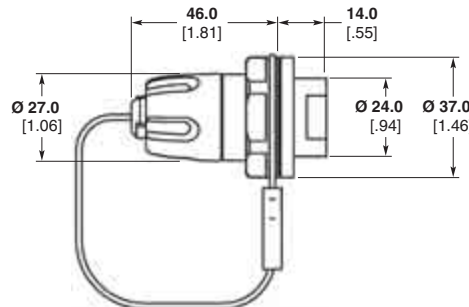

PRO BEAM Jr. Low Profile D-Hole Bulkhead

PRO BEAM Expanded Beam Rugged Optics Products (Continued)

PRO BEAM Jr. Connectors
(Continued)

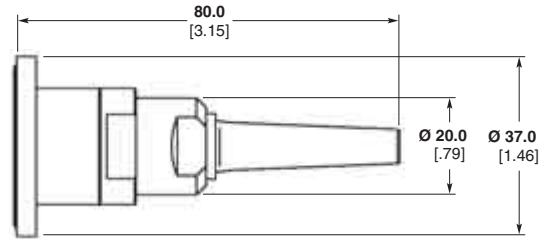

Standard Bulkhead Cable Adapter, with Boot

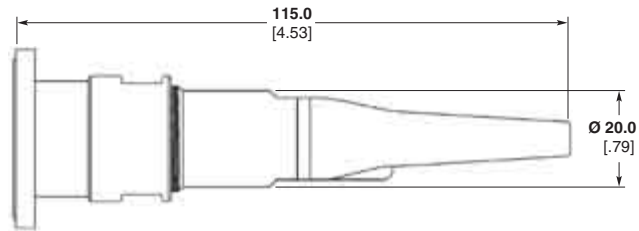

Environmentally Sealed Bulkhead Cable Adapter, with Boot

PRO BEAM Jr. Replacement Receptacles for TFOCA-II Panel Mount Connector Applications
(see page 85 for Part Numbers)

Panel Cutout Dimensions

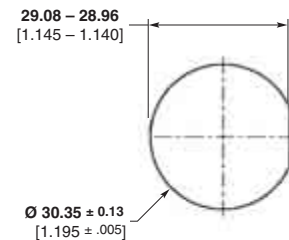
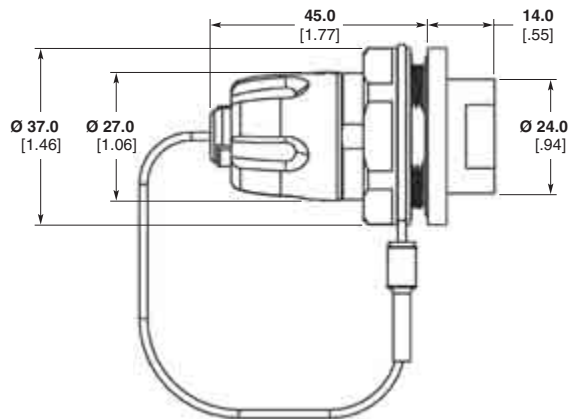

Recommended TFOCA-II® Panel Cutout

PRO BEAM Jr. D-Hole Low Profile Buffered Fiber Bulkhead Replacement Connector for TFOCA-II Product

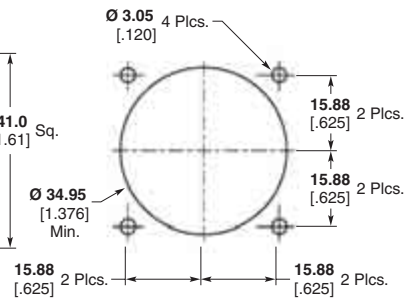
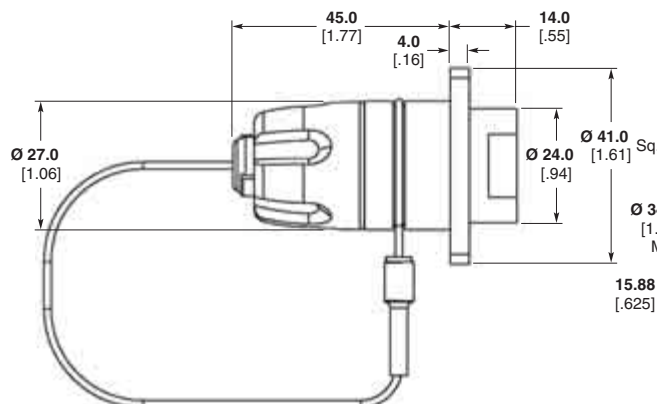

Recommended TFOCA-II® Panel Cutout

TFOCA-II is a trademark of Amphenol Fiber Systems International.

PRO BEAM Jr. Square Flange, Low Profile, Buffered Fiber Bulkhead Replacement for TFOCA-II Product

PRO BEAM Expanded Beam Rugged Optics Products (Continued)

PRO BEAM Jr. Connectors

(Continued)

Connector Assembly

- 1 Shell Kit
- 1 Insert Kit
- 1 Cable Adapter Kit*
- X Ferrule Kits (X = No. of optical channels)

Part Numbers listed are Shell alloy = aluminum
Plating = hard anodized.
Consult Tyco Electronics for other plating/material options such as NiAlBz for Naval applications.

ASSEMBLY CAPABILITIES

Tyco Electronics has extensive rugged optic harness capabilities. Please consult your local Tyco Electronics Sales Representative for assistance.

Technical Documents

Product Specification

108-2177 Design Objectives

Application Specification

114-13099

Instruction Sheets

- 408-8791 Grounding D-Hole Bulkhead
- 408-8797 Plug
- 408-8798 Standard D-Hole Bulkhead
- 408-8811 Sealed D-Hole Bulkhead
- 408-8834 Low Profile Square Flange Bulkhead
- 408-8840 Low Profile D-Hole Bulkhead
- 408-8841 Standard Square Flange Bulkhead

<http://www.tycoelectronics.com/documents>

PRO BEAM Jr. Connector Shell Kits

Description	Part Number
PRO BEAM Jr. Plug w/EPDM rubber	1754436-1
PRO BEAM Jr. Plug w/Fluorosilicone rubber	1754436-2
PRO BEAM Jr. D-Hole Low Profile, Buffered Fiber Bulkhead	1693741-1
PRO BEAM Jr. D-Hole Standard Bulkhead	1754437-1
PRO BEAM Jr. D-Hole Sealed Bulkhead	1754438-1
PRO BEAM Jr. Square Flange Low Profile Buffered Fiber Bulkhead	1754439-1
PRO BEAM Jr. Square Flange Standard Bulkhead	1754440-1
PRO BEAM Jr. Square Flange Sealed Bulkhead	1754441-1

PRO BEAM Jr. Replacement Receptacles for TFOCA-II Panel Mount Connector Applications

Description	Part Number
PRO BEAM Jr. TFOCA-II Replacement D-Hole Low-Profile Buffered Fiber Bulkhead	1754445-1 ♦
PRO BEAM Jr. TFOCA-II Replacement D-Hole Sealed Bulkhead	1754446-1 ♦
PRO BEAM Jr. TFOCA-II Replacement Square Flange Low-Profile Buffered Fiber Bulkhead	1754447-1 ♦
PRO BEAM Jr. TFOCA-II Replacement Square Flange Sealed Bulkhead	1754448-1 ♦

PRO BEAM Jr. Insert Kits

Description	Part Number
2 x 850 / 1300 nm Multimode	1515743-1
2 x 1310 nm Singlemode	1515739-1
2 x 1550 nm Singlemode	1516040-1
4 x 850 / 1300 nm Multimode	1515747-1
4 x 1310 nm Singlemode	1515740-1
4 x 1550 nm Singlemode	1516041-1

Ferrule Kits

Fiber Hole Size	Mode	PRO BEAM Connector	Part Number
125 µm	SM	PRO BEAM Jr.	1588908-2
126 µm	SM	PRO BEAM Jr.	1588908-1
126 µm	MM	PRO BEAM Jr.	1588700-1

PRO BEAM Jr. Connector Plug & Sealed Bulkhead Cable Adapter Kits

Cable Dia. (Max.)	Part Number
3.10 .122	1515814-1
3.60 .142	1515781-3
4.10 .161	1515848-2
4.60 .181	1516147-1
5.10 .201	1515834-2
5.65 .222	1515827-2
6.10 .240	1515859-3
6.70 .264	1588116-1
7.50 .295 (Breakout Cable Only)	1828168-1 (Plug)
7.50 .295	1754719-3 (Sealed Bulkhead)

PRO BEAM Jr. Connector Standard Bulkhead Cable Adapter Kits*

Cable Dia. (Max.)	Part Number
3.10 [.122]	1515791-2
3.60 [.142]	1515808-1
5.10 [.201]	1515835-2
5.65 [.222]	1515829-1
6.10 [.240]	1515796-2
4 x 3.00 [4 x .118]	1515749-1

*Standard Cable Adapter — Not applicable for Low Profile.

Note: Part Numbers are RoHS compliant except: ♦ Indicates non-RoHS compliant.

PRO BEAM Expanded Beam Rugged Optics Products (Continued)

PRO BEAM Jr. Connectors

(Continued)

Spare Parts & Tools

Technical Documents

Product Specifications

- 408-8857 Curing Fixtures for PRO BEAM Jr. and PRO BEAM Sr. Connectors
 408-8828 Cleaning Procedure for EB C/A's

Tooling Specifications

- 408-8795 Crimp Tool with Die Set for PRO BEAM Jr. and PRO BEAM Sr. Connectors
 408-10022 Die Assembly for PRO BEAM Mini and PRO BEAM Jr. Circular Crimps

<http://www.tycoelectronics.com/documents>

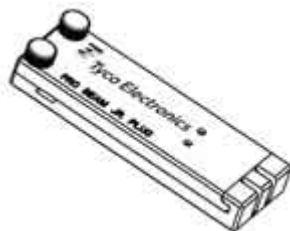

Curing Fixtures

Connector	Part Number
PRO BEAM Jr. Cable Plug (having cable with KEVLAR strength member fiber)	1693797-1
PRO BEAM Jr. Sealed D-Hole Bulkhead	1693800-1
PRO BEAM Jr. Standard D-Hole and Square Flange Bulkhead	1754122-1
PRO BEAM Jr. Low Profile Buffered Fiber Bulkhead	

Instruction Sheet 408-8857. Available at www.tycoelectronics.com

Cable Crimp Components

Description	Part Number
Crimp Sleeve (use with all PRO BEAM Jr. Connector Crimp Support sizes)	1515269-2
2.2 mm Crimp Support	1515567-1
3.1 mm Crimp Support	1515568-1
3.6 mm Crimp Support	1515569-1
3.8 mm Crimp Support	1515570-1
4.1 mm Crimp Support	2-1515270-0
4.6 mm Crimp Support	1516142-1
5.1 mm Crimp Support	1515571-1
5.65 mm Crimp Support	1515572-1
6.1 mm Crimp Support	1515573-1
6.5 mm Crimp Support	1515574-1
6.7 mm Crimp Support	1515575-1
Square Crimp Support for (4) 3 mm Cables	1515632-1

Ferrule Kits

Fiber Hole Size	Mode	PRO BEAM	Part Number
125 μm	SM	PRO BEAM Jr.	1588908-2
126 μm	SM	PRO BEAM Jr.	1588908-1
126 μm	MM	PRO BEAM Jr.	1588700-1

Protective Caps

Description	PRO BEAM	Part Number
Standard cap, for D-Hole Bulkhead	PRO BEAM Jr.	1515868-1
Standard cap, for Flange Mount Bulkhead	PRO BEAM Jr.	1515787-2
Standard cap, for connector plug	PRO BEAM Jr.	1515867-1

Kevlar® is a trademark of E.I. du Pont de Nemours and Company.

Note: All part numbers are RoHS compliant.

PRO BEAM Expanded Beam Rugged Optics Products (Continued)

PRO BEAM Mini Connectors

Tyco Electronics is pleased to announce the natural extension from our PRO BEAM Sr. and PRO BEAM Jr. Connector product lines.

The PRO BEAM Mini Connector saves space and weight and is perfect for high density applications. The product offers the same durability as its larger counterparts.



PRO BEAM Sr., PRO BEAM Jr. & PRO BEAM Mini Connectors



PRO BEAM Mini Plug Connector

Connector Assembly

- 1 Shell Kit
- 1 Insert Kit
- 1 Cable Adapter Kit*
- X Ferrule Kits (X = No. of optical channels)

*Not applicable for Low Profile

PRO BEAM Mini Connector Shell Kits

Type	Mount Style	Attribute Difference	Part Number		
			(HA Aluminum)	(OD Aluminum)	(NiAlBronze)
Plug		EPDM Grip	1828698-1	N/A	1828698-2
Bulkhead	D-Hole	Low Profile - Buffered Fiber	1828699-1	1828699-2 ♦	1828699-3
		Low Profile - 1.8 Jacketed	1985140-1	1985140-2	1985140-3
	Square Flange	Sealed	1918185-1	*	1918185-2
		Low Profile - Buffered Fiber	1828826-1	*	*
		Neutrik Cutout-Drop-In	1918603-1	*	*

* Contact Tyco Electronics for availability.

PRO BEAM Mini Insert Kits

Description	Part Number
2 x 850 / 1300 nm Dual Multimode	1374759-4
2 x 1310 nm Singlemode	1588129-2
2 x 1550 nm Singlemode	1588128-2
4 x 850 / 1300 nm Dual Multimode	1374759-2
4 x 1310 nm Singlemode	1588129-3
4 x 1550 nm Singlemode	1588128-3

Ferrule Kits

Fiber Hole Size	Mode	PRO BEAM Connector	Part Number
125 µm	SM	PRO BEAM Mini	1754700-1
126 µm	SM	PRO BEAM Mini	1754700-2
126 µm	MM	PRO BEAM Mini	1754699-1

PRO BEAM Mini Cable Adapter Kits For Plug

Cable Diameter	Part Number
5 mm	1828700-1
5.5 mm	1828700-2
6 mm	1828700-3

ASSEMBLY CAPABILITIES

Tyco Electronics has extensive rugged optic harness capabilities. Please consult your local Tyco Electronics Sales Representative for assistance.

Note: Part Numbers are RoHS compliant except: ♦ Indicates non-RoHS compliant.

PRO BEAM Expanded Beam Rugged Optics Products (Continued)

PRO BEAM Mini Connectors

(Continued)

Performance Specifications

Optical, Multimode Version

Insertion Loss, Typical —
0.7 dB @ 1300 nm*

Optical, Singlemode Version

Insertion Loss, Typical —
0.8 dB @ 1310 nm*

Return Loss — > 34 dB @ 1310 nm
or 1550 nm**

*When tested with reference quality
launch/receive cable assemblies

**RL Tested Open Ended

Mechanical

Vibration, Sinusoidal —

10 - 500 Hz, 3 directions;
0.75 mm amplitude @ 10g acceleration

Bump — 4,000 Bumps, 3 directions
@ 40g acceleration

Free Fall — 500 falls on concrete;
Severity 1.2 m

Coupling Endurance —
3,000 couplings

Weight —

Plug — 50 grams, typical
D-Hole bulkhead — 39 grams, typical

Temperature

Operational Temperature —

-40°C/+85°C

Storage Temperature —

-55°C/+85°C

Temperature, Cyclic —

-55°C/+85°C

Humidity (Damp Heat) — 95% RH

Immersion

Water — 5 m depth (plug) -
2 m (Bulkhead)

Pressure

Low Pressure — 25 kPa @ -55°C

Material and Finish

Shell Alloy — Aluminum; or nickel
aluminum bronze (high saline environ-
ment)

Plating (For Aluminum Shells

Only) — clear hard anodized; or green
chromate conversion zinc (PRO BEAM
Jr. Bulkheads only)

Technical Documents

408-10065 Plug

408-10067 Square Flange Bulkhead

408-10069 Low Profile D-Hole Bulkhead

408-10076 Sealed D-Hole Bulkhead

<http://www.tycoelectronics.com/documents>

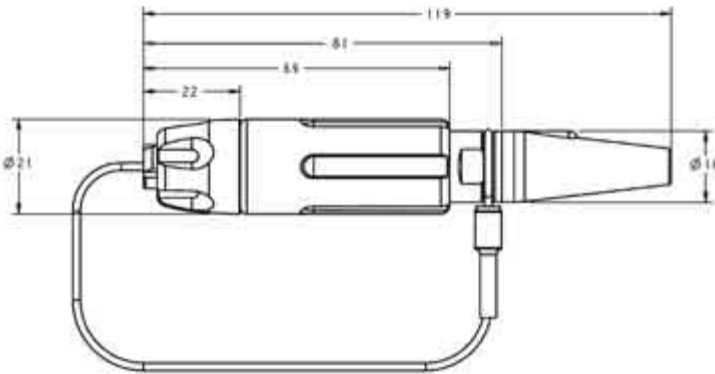

PRO BEAM Mini Cable Connector, Plug

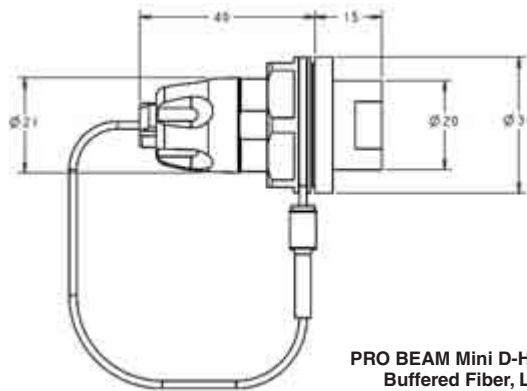

PRO BEAM Mini D-Hole Bulkhead,
Buffered Fiber, Low Profile

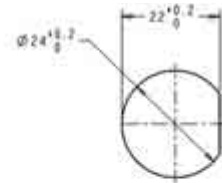

Recommended Panel Cutout

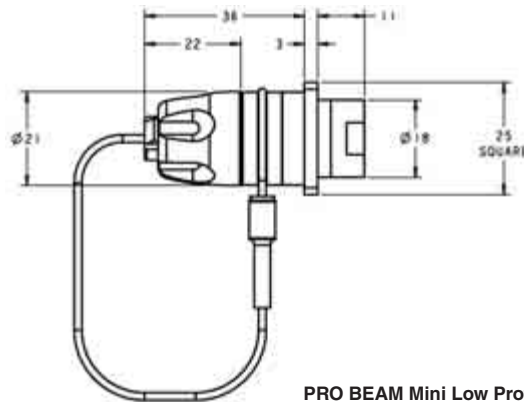

PRO BEAM Mini Low Profile, Square Flange Mount Bulkhead

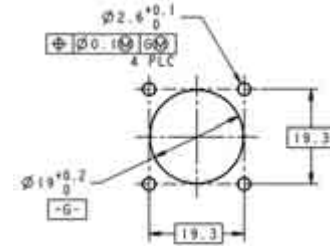

Recommended Panel Cutout

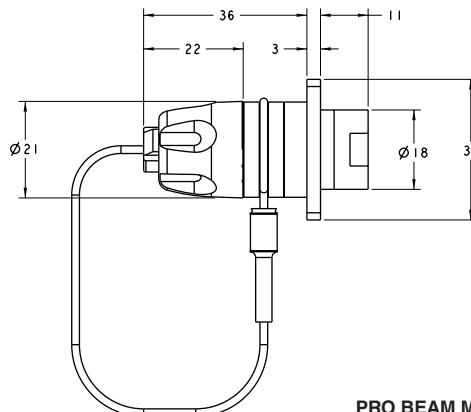

PRO BEAM Mini Bulkhead with XLR Flange

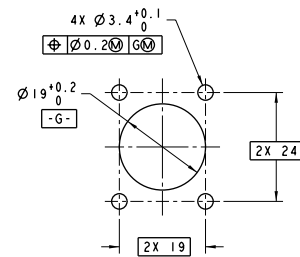

Recommended Panel Cutout

PRO BEAM Expanded Beam Rugged Optics Products (Continued)

PRO BEAM Mini Connectors

(Continued)

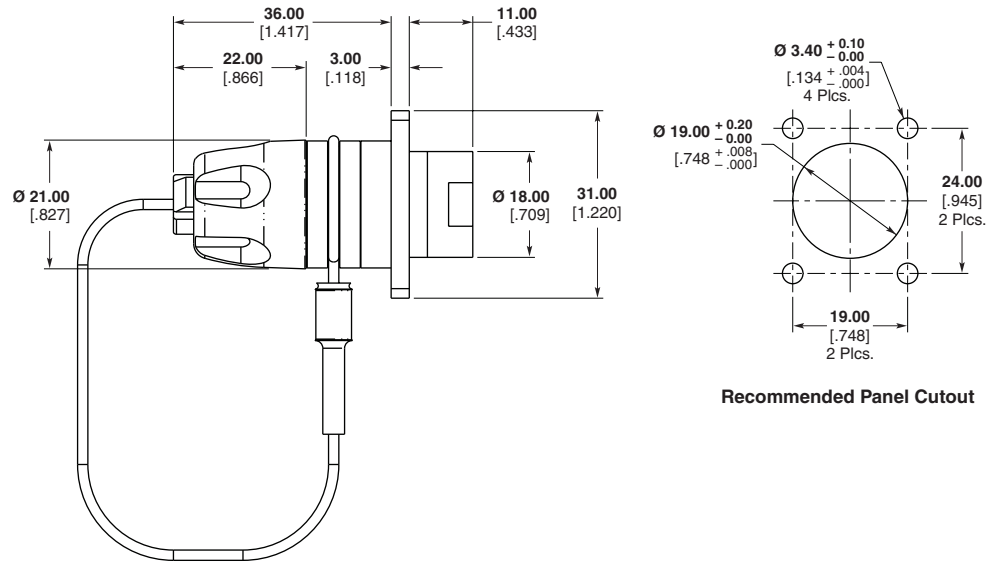

**PRO BEAM Mini Low Profile,
Alternate Square Flange Mount Bulkhead**

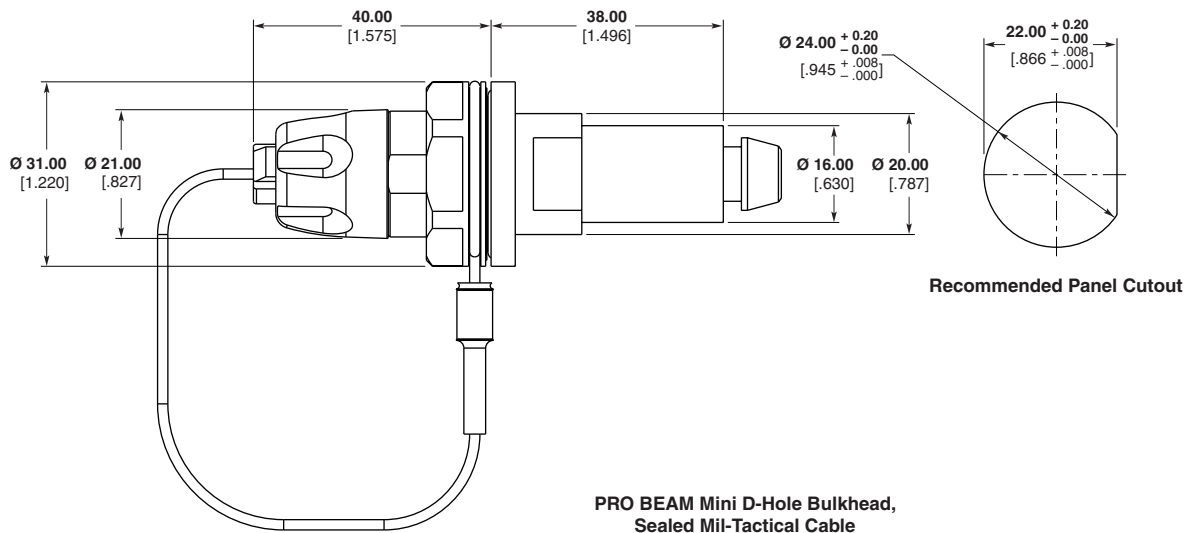

**PRO BEAM Mini D-Hole Bulkhead,
Sealed Mil-Tactical Cable**

PRO BEAM Expanded Beam Rugged Optics Products (Continued)

PRO BEAM Sr. Connectors

Performance Specifications

Optical, Multimode Version
Insertion Loss, Typical —
0.7 dB @ 1300 nm*

Optical, Singlemode Version
Insertion Loss, Typical —
0.7 dB @ 1310 nm*

Return Loss — > 34 dB
@ 1310 nm or 1550 nm**

*When tested with reference quality
launch/receive cable assemblies

**RL Tested Open Ended

Mechanical

Vibration, Sinusoidal —
10 - 500 Hz, 3 directions;
0.75 mm amplitude @ 10g acceleration

Bump — 4,000 Bumps, 6 directions,
@ 50g acceleration

Free Fall — 500 falls on concrete;
Severity 1.2 m

Coupling Endurance —
3,000 couplings

Weight —
Plug — 290 grams, typical
Chassis bulkhead — 150 grams, typical

Temperature

Operational Temperature —
-40°C/+85°C

Storage Temperature —
-55°C/+85°C

Temperature, Cyclic —
-55°C/+85°C

Humidity (Damp Heat) — 95% RH

Immersion

Water — 5 m depth (plug),
2 m (Bulkhead)

Material and Finish

Shell Alloy — Aluminum; or nickel
aluminum bronze (high saline environ-
ment)

**Plating (For Aluminum Shells
Only)** — clear hard anodized

**Bulkhead Connector Panel
Thicknesses**

PRO BEAM Sr. D-Hole Connector —
6.5 mm max.

**PRO BEAM Sr. Square Flange
Connector** — 8.5 mm max.

Technical Documents

Product Specifications
408-8799 Plug
408-8800 D-Hole Bulkhead
408-8877 Square Flange Bulkhead

Application Specification

114-13122
<http://www.tycoelectronics.com/documents>

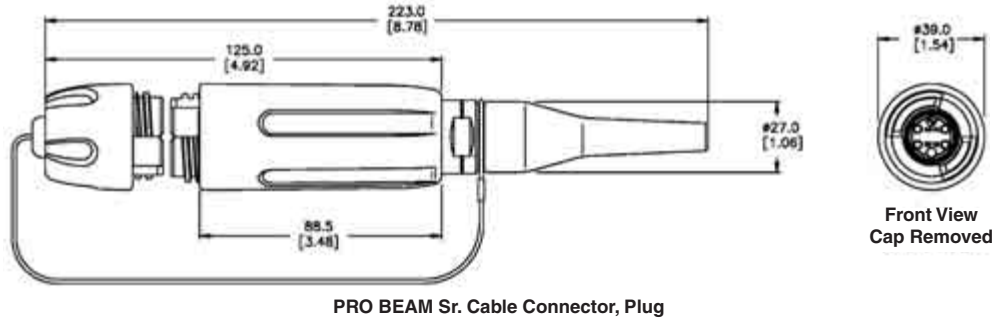

PRO BEAM Sr. Cable Connector, Plug

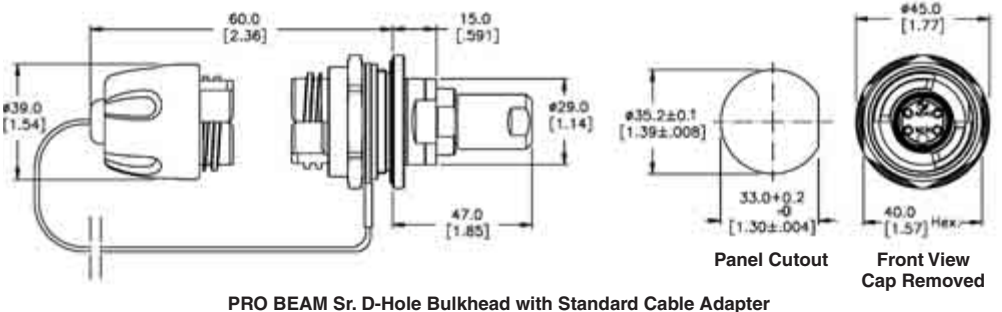

PRO BEAM Sr. D-Hole Bulkhead with Standard Cable Adapter

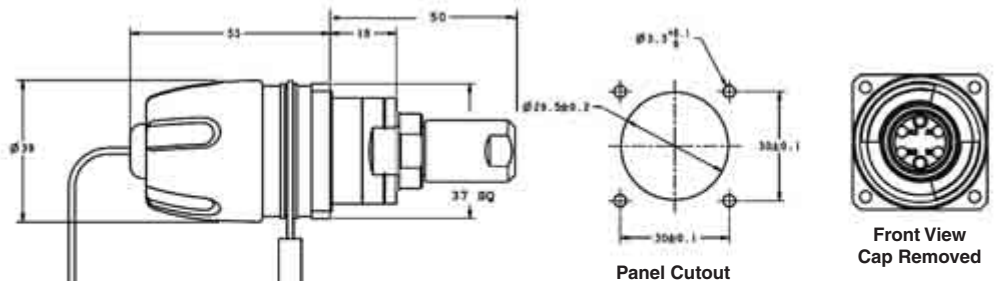

PRO BEAM Sr. Square Flange Mount Bulkhead with Standard Cable Adapter

**Please contact your local
Tyco Electronics
Sales Representative
for Part Numbers and
availability.**

PRO BEAM Expanded Beam Rugged Optics Products (Continued)

PRO BEAM Sr. Connectors

(Continued)

Connector Assembly

- 1 Shell Kit
- 1 Insert Kit
- 1 Cable Adapter Kit*
- X Ferrule Kits (X = No. of optical channels)

*Not applicable for Low Profile

Part numbers listed are Shell alloy = aluminum Plating = hard anodized. Consult Tyco Electronics for other plating/material options such as NiAlBz for Naval applications.

PRO BEAM Sr. Connector Shell Kits	Part Number
PRO BEAM Sr. Plug w/EPDM rubber	1754842-1
PRO BEAM Sr. D-Hole Standard Bulkhead	1754843-1
PRO BEAM Sr. Square Flange Standard Bulkhead	1754844-1

PRO BEAM Sr. Insert Kits	Part Number
2 x 850 / 1300 nm Multimode	1693001-1
2 x 1310 nm Singlemode	1515734-2
4 x 850 / 1300 nm Multimode	1693001-2
4 x 1310 nm Singlemode	1515735-1

Ferrule Kits

Fiber Hole Size	Mode	PRO BEAM Connector	Part Number
125 µm	SM	Sr.	1515941-1
126 µm	SM	Sr.	1515941-2
126 µm	MM	Sr.	1588801-1

PRO BEAM Sr. Connector Plug Adapter Kits

Cable Dia. (Max.)	Part Number
5.10 .201	1515940-1
5.65 .222	1515940-3
6.20 .244	1515940-5

Technical Documents

Product Specifications

- 408-8857 Curing Fixtures for PRO BEAM Jr. and PRO BEAM Sr. Connectors
- 408-8828 Cleaning Procedure for EB C/A's

Tooling Specifications

- 408-8795 Crimp Tool with Die Set for PRO BEAM Jr. and PRO BEAM Sr. Connectors
- 408-10022 Die Assembly for PRO BEAM Mini and PRO BEAM Jr. Circular Crimps

<http://www.tycoelectronics.com/documents>

PRO BEAM Sr. Connector Standard Bulkhead Cable Adapter Kits

Cable Dia. (Max.)	Style	Part Number
5.10 .201	Standard Cable Adapter	1515847-1
5.65 .222	Standard Cable Adapter	1515724-2
Buffered Fiber	Low Profile Adapter	1515299-2

ASSEMBLY CAPABILITIES

Tyco Electronics has extensive rugged optic harness capabilities. Please consult your local Tyco Electronics Sales Representative for assistance.

Note: All part numbers are RoHS compliant.

PRO BEAM Expanded Beam Rugged Optics Products (Continued)

Cable Assemblies and Accessories

Product Facts

- Ruggedized cable assemblies custom tailored for field use in harsh environments
- Heavy-duty light-weight cable reel organizes and protects connectors and cable for easy pay-out and safe storage
- Options for 500 meter reels include special backpack harnesses, a separate reel stand, or a combination reel and reel stand

Featured Cable Assemblies



TFOCA to PRO BEAM Jr. Plug Cable Assembly
1828536-1 ◆

LP D-Hole Bulkhead to 4 ST 62.5/125 on 1.8 mm cable
6828454-1 ◆

Plug to Plug (100 meters)
6754475-2

Typical Reels and Reel Stands for Field-Deployable Cable Assemblies



1918930-1



Tactical Reel/Drum Options

PRO BEAM Jr. Kits

PRO BEAM Jr. Termination Kit
1828650-1

Cleaning Kit
1828335-2

Cable Reels

Reel Capacity (Random Lay)

Cable Diameter		Notes/Description	Flange Diameter	Part Number
5.0 mm	5.5 mm			
225 M	186 M	Reel & Reel Stand Combination Reel can be detached from stand without tools	310 mm	1918930-1
297 M	247 M	Reel*	310 mm	1754515-1
570 M	462 M	Reel*	370 mm	1754515-2
998 M	816 M	Reel*	460 mm	1754515-3
1271 M	1052 M	Reel*	510 mm	1754515-4

* See Accessories options below

ASSEMBLY CAPABILITIES

Tyco Electronics has extensive rugged optic harness capabilities. Please consult your local Tyco Electronics Sales Representative for assistance.



Backpack with Reel



Reel with Stand "Static Frame"



Backpack Harness

Accessories

Description	Reel Diameter	Part Number
Backpack	370 mm Dia. Reel	1754516-1*
Backpack	460 mm Dia. Reel	1754516-2*
Backpack	510 mm Dia. Reel	1754516-3*
Static Frame	500 mm Dia. Max	1754517-1*
Static Frame	700 mm Dia. Max	1754517-2*

* Reel must be ordered separately.

Note: For lower cost alternative options. Please contact your local Tyco Electronics' Sales Representative or Tyco Electronics Product Information Center at 1-800-522-6752.

Note: Part Numbers are RoHS compliant except: ◆ Indicates non-RoHS compliant.

TFOCA-II is a trademark of Amphenol Fiber Systems International.

PRO BEAM Expanded Beam Rugged Optics Products (Continued)

**Tactical Field
Splice Repair Kit
Part Number 1985212-1**



Materials List

Quantity	Description
4	Flexible Splice Housings
10	Mechanical Splices
1	Cleaver
1	Cable Stripper
2	Buffer Stripper (sizes): 126 micron, 200 micron
1	Utility Knife with 3 Spare Blades
1	KEVLAR Shears
1	6 inch Metal Ruler, (units in metric)
1	Illuminated Microscope with Batteries
40	Alcohol (at least 70%) Pads
1	Wipes, 5 x 8 inch, 280 count box
1	Plastic Frame Safety Glasses (ANSI approved lenses)
1	Tweezers
1	Roll Tape
1	Fine Tip Marking Pen
1	Set of Instructions (illustrated) — Waterproof
1	Portable Field Storage Case. This case shall be ruggedized and house all components necessary to repair broken cable. Dimensions of the case shall not exceed 7.5" H x 20" W x 14" — Black in color.

KEVLAR is a trademark of E. I. du Pont de Nemours and Company.

Note: All part numbers are RoHS compliant.

PRO BEAM Expanded Beam Rugged Optics Products (Continued)

Optical Test Set for Fiber Optic Cables — Designed for harsh environments

Product Facts

- Especially designed to support the installation of optical links in the field
- Able to test both cable drums and entire links
- Powered by batteries with high autonomy
- Suitable for diagnostics and construction teams
- Easy to use, ergonomic, rugged design
- Suitable for cable length up to 10 km
- Supports up to 4 fibers per cable with various types of connectors



Diagnostic Features

Power Meter

The optical power from any source can easily be measured with the power meter function.

Optical Source

A continuous optical signal is generated and transmitted with selectable output power.

Drum Test / Cable Test

Test of an entire cable drum with automatic good/bad indication. The test of an entire cable is realized with a 2nd KPG-opt or a loop connector.

Test Frames (optional)

The KPG-opt can generate specific test frames as used in optical networks and LOS systems.

Optical Tester

Description	Part Number
850 nm 38999 III Size 11 Optical Test Kit	1918016-1
850/1300 nm PRO BEAM Jr. Optical Test Kit	1918016-2
1310 nm PRO BEAM Jr. Optical Test Kit	1985006-1

For additional wavelength testers, contact your local Tyco Electronics Sales Representative.

Protective Case
1918082-1

Note: All part numbers are RoHS compliant.

PRO BEAM Expanded Beam Rugged Optics Products (Continued)

ARMOR-LIGHT Tactical Field Deployable Fiber Optic Cable for Extreme Environments (Metallic for Rodent Proof)



4-Color Optical Fiber Cable Specification for Armored Cable for Ruggedized Applications

Construction:

- 4-color coded fibers
- Fiber types 50/125/250 μm, 62.5/125/250 μm and 9/125/250 μm
- Stainless steel gel filled tube
- Stainless steel wire
- Jacket — Nylon, black

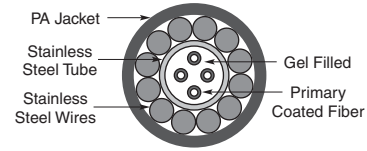

Fiber Type	Part Number	Outside Dia. (mm)	Weight kg/km	Max. Attenuation dB/km				Bandwidth MHz-km	
				850 nm	1300 nm	1310 nm	1550 nm	850 nm	1300 nm
62.5/125	1588957-1	3.8	24	3.5	1.0	X	X	160	500
50/125	1588957-2	3.8	24	2.7	0.9	X	X	400	1200
SM	1588957-4	3.8	24	X	X	0.40	0.25	X	X

Notes: 35 mm recommended bend radius.
3.1 kN breaking strength.

2-Color Optical Fiber Cable Specification for Armored Cable for Ruggedized Applications

Construction:

- 2-color coded fibers
- Fiber types 50/125/250 μm, 62.5/125/250 μm and 9/125/250 μm
- Stainless steel gel filled tube
- Stainless steel wire
- Jacket — Nylon, black

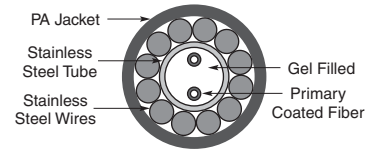

Fiber Type	Part Number	Outside Dia. (mm)	Weight kg/km	Max. Attenuation dB/km				Bandwidth MHz-km	
				850 nm	1300 nm	1310 nm	1550 nm	850 nm	1300 nm
62.5/125	1693808-1	3.8	24	3.5	1.0	X	X	160	500
50/125	1693808-2	3.8	24	2.7	0.9	X	X	400	1200
SM	1693808-4	3.8	24	X	X	0.40	0.25	X	X

Notes: 35 mm recommended bend radius.
3.1 kN breaking strength.

Note: All part numbers are RoHS compliant.

Fiber to the Antenna

5

Non-Metallic Tactical Field Deployable Fiber Optic Cable

Product Facts

- All terrain field deployable cable, up to 4 fibers, singlemode or multimode
- Developed for deployment under the most demanding conditions
- Tight buffered fibers are protected by Aramid yarns and a tough ruggedized polyurethane sheath
- Tested in accordance with MIL-PRF-85045
- Flexible, water resistant, high crush resistant, and lightweight,
- Designs available to be resilient against radiation exposure

Technical Data

Mil-Standard Distribution Cable — 2 Fiber Singlemode

Attenuation — ≤ 0.5 dB/km @ 1310 nm / ≤ 0.5 dB/km @ 1550 nm
Diameter — 5.8 mm
Weight — 25 kg/km
Minimum Bending Radius — 29 mm
Crush Resistance — 2000 N/cm
Operating Temperature — -55° C to +85° C

Mil-Standard Distribution Cable — 4 Fiber Singlemode

Attenuation — ≤ 0.5 dB/km @ 1310 nm / ≤ 0.5 dB/km @ 1550 nm
Diameter — 5.8 mm
Weight — 27 kg/km
Minimum Bending Radius — 28 mm
Crush Resistance — 2000 N/cm
Operating Temperature — -55° C to +85° C

Mil-Standard Distribution Cable — 2 Fiber Multimode

Fiber Type — 50 μm/125 μm and 62.5/125
Attenuation — ≤ 3.5 dB/km @ 850 nm / ≤ 1.0 dB/km @ 1300 (62.5/125); ≤ 3.5 dB/km @ 850 nm / ≤ 1.5 dB/km @ 1300 (50/125)

Mil-Standard Distribution Cable — 4 Fiber Multimode

Fiber Type — 50 μm/125 μm and 62.5/125
Attenuation — ≤ 3.5 dB/km @ 850 nm / ≤ 1.0 dB/km @ 1300 (62.5/125); ≤ 3.5 dB/km @ 850 nm / ≤ 1.5 dB/km @ 1300 (80/125)

Other fibers (i.e. Polyimide, Silicon buffer, Carbon coated, radiation hardened, etc.) are available upon request.

Contact Tyco Electronics or your local Tyco Electronics Sales Representative for part numbers, pricing, and availability.

PRO BEAM Expanded Beam Rugged Optics Products (Continued)

Hand Held Visual Fault Locator (VFL)

Product Facts

- 650 nm (visible) Class 2
1.0 mW max Diode Laser
- Continuous and flashing
(2-3 Hz pulsed) modes
- Rugged rubber shell and
body design modeled after a
popular military connector
- Lanyard attached dust cover
- Standard 2.5 mm adapter for
SC, ST, and FC connectors
- Optional 1.25 mm adapter
for LC and MU connectors.
- Unique design allows
adapter to permanently
reside on VFL so it is not
misplaced allowing user to
choose 1.25 mm or 2.5 mm
- Uses 1 "AA" style battery
for >30 hours of continuous
use
- Soft-sided belt case for
convenience and storage



The Tyco Electronics Hand Held Visual Fault Locator (VFL) is a rugged and affordable solution for identifying breaks and bending in optical fibers and cabling. Its powerful, red (650 nm) laser provides the ability to locate damaged, broken, or tightly bent fibers that cause undesirable attenuation in your system.

The jacket of the cable will glow red at the location of the fault. The flash button

allows the user to toggle between continuous or pulsed mode. The compact, rugged, and balanced design is based upon a popular harsh environment fiber optic connector. The single "AA" style battery is good for >30 hours of continuous use and the soft-sided protective case with belt loop provides a convenient and protective means of storage.

Applications

Affordable VFL Solution for:

- Identifying breaks, bends, and other damage in optical fibers
- Tracing fiber paths
- Identifying termination errors
- Continuity testing

Product Dimensions

- Length** — 18.5 cm [7.283 in]
- Width** — 2.2 cm [0.866 in]
- Thickness** — 2.2 cm [0.866 in]
- Weight (w/battery)** — 150 g [0.33 lb]

Description	Part Number
Hand Held Visual Fault Locator	1828352-1
1.25 mm Adapter for Hand Held VFL	1828353-1
Includes Part Numbers 1828352-1 and 1828353-1	1828352-2

**Combination
LIGHTCRIMP PLUS
SC/ST/LC Termination Kit
Part Number 1985162-1**



Note: All part numbers are RoHS compliant.

Part Number Index

Note: This index lists all cataloged parts by base no. only. Complete part nos. (with prefixes and/or suffixes) are shown on the page(s) indicated.

Part No.	Page	Part No.	Page	Part No.	Page
492234	19	1588700	85	1919166	17
492305	19	1588801	91	1938208	14
492739	19	1588908	85	1938209	14
501049	46	1588957	95	1938323	12, 14
501050	46	1693001	91	1938324	12, 14
501055	46	1693539	41	1985140	87
501381	43	1693540	41	1985149	35
501457	43	1693560	67	1985150	35
502128	43	1693741	85	1985193	81
502716	32, 33	1693808	95	1985834	77
502750	43	1695790	13, 35	1985835	77
503219	43	1754371	32, 48	1985836	77
503571	42	1754436	85	1985837	77
503970	37	1754437	85	1985838	77
504021	43	1754438	85	1985839	78
504028	46	1754439	85	1985840	78
504031	46	1754440	85	1985841	78
1278017	47	1754441	85	1985842	78
1278391	21	1754445	85	1985843	78
1278530	20	1754446	85	1985844	77
1278705	37, 38	1754447	85	1985845	77
1374490	20	1754448	85	1985846	77
1374491	20	1754625	32	1985847	77
1374737	32, 33	1754682	34	1985848	77
1374759	87	1754683	34	2064184	48
1457062	35	1754699	87	2064658	13, 34
1515299	91	1754700	87	2064685	34
1515724	91	1754719	85	2064687	31
1515734	91	1754727	34	2064752	13, 34
1515735	91	1754842	91	2064778	10
1515739	85	1754843	91	2064779	10
1515740	85	1754844	91	2064781	10
1515743	85	1828028	39	2064782	10
1515747	85	1828168	85	2064792	16
1515749	85	1828184	32, 33	2064812	10
1515781	85	1828456	32	2064813	10
1515791	85	1828536	92	2064814	10
1515796	85	1828573	36	2064815	10
1515808	85	1828574	36	2064843	27
1515814	85	1828618	80	2064844	27
1515827	85	1828619	80	2064845	27
1515829	85	1828698	87	2064846	27
1515834	85	1828699	87	2064847	27
1515835	85	1828700	87	2064848	27
1515847	91	1828740	80	2064849	27
1515848	85	1828826	87	2064850	27
1515859	85	1828935	80	2064851	27
1515940	91	1828936	80	2064852	27
1515941	91	1918153	31	2064853	27
1516040	85	1918154	36	2064854	27
1516041	85	1918177	80	2064856	27
1516147	85	1918185	87	2064858	27
1588116	85	1918227	36	2064859	27
1588128	87	1918228	31	2064860	27
1588129	87	1918356	47	2064861	27
1588153	32, 33	1918403	32, 33	2064862	12, 27
1588172	16	1918404	30	2064863	12, 27
1588491	37, 38	1918405	30	2064865	27
		1918406	30	2064866	27
		1918407	30	2064867	27
		1918603	87	2064868	27
		1918918	32	2064869	27
				2064870	27
				2064871	27
				2064872	27
				2064873	27
				2064874	27
				2064877	12
				2064880	12
				2064883	12
				2064886	12
				2064889	12
				2064937	30
				2064938	13, 30
				2064939	13, 36
				2064940	36
				5209250	67
				5209285	68
				5209570	69
				5209597	68
				5209943	67
				5209948	68
				5417021	68
				5417399	69
				5417549	69
				5492123	37
				5492181	46
				5492221	16
				5492458	42
				5492515	24
				5492642	48
				5492643	48
				5501474	43
				5501506	44
				5502136	46
				5502580	42
				5502585	43
				5502632	13, 39
				5502667	43
				5502674	42
				5502776	13, 39
				5502780	40
				5502781	45
				5503137	41
				5503141	27
				5503415	42
				5503613	42
				5503628	43
				5503640	45
				5503839	16
				5503948	37
				5503971	37, 38
				5504008	42
				5504013	44
				5504014	46
				5504022	43
				5504026	46
				5504118	32
				5504407	44
				5504566	46
				5504567	46
				5504614	39
				5504632	13, 39
				5504634	40

Part Number Index (Continued)

Part No.	Page	Part No.	Page	Part No.	Page	Part No.	Page
5504640	39	6278350	40, 41	6374743	23	6588871	70
5504649	44	6278398	47	6374887	24	6588967	17
5504655	36	6278399	47	6374906	47	6693067	17
5504657	13, 36	6278529	21	6457078	23	6693068	17
5504663	41	6278750	47	6457173	23	6693069	17
5504883	27	6278751	47	6457174	23	6693276	48
5504915	44	6348522	37, 48	6457394	23	6754264	44
5504927	36	6374150	32	6457398	23	6754475	92
5504928	13	6374223	40	6457493	37, 38	6754482	48
5504936	36	6374392	23	6457543	32, 33	6754483	48
6278049	40	6374448	23	6457567	13, 34	6828094	31
6278050	45	6374493	20	6457981	16	6828095	31
6278051	41	6374537	23	6457983	16	6828099	36
6278079	48	6374538	23	6588189	32	6828100	36
6278082	48	6374539	23	6588291	48	6828129	31
6278309	37, 38	6374600	23	6588572	12	6828130	31
6278348	39	6374639	23	6588573	12	6828454	92
6278349	45	6374738	23	6588612	32, 33		

Tooling and Accessories Part Number Index

Note: This index lists all cataloged parts by base no. only. Complete part nos. (with prefixes and/or suffixes) are shown on the page(s) indicated.

Part No.	Page	Part No.	Page	Part No.	Page		
58424	56	503746	51	1515574	86	1828353	96
58433	56	503890	56	1515575	86	1828833	53
58551	56	503910	56	1515632	86	1828834	25, 53
58552	56	503911	56	1515787	86	1828835	25, 53
228025	56	503967	25	1515867	86	1828836	53
492025	56	504035	52	1515868	86	1828837	53
492026	56	504064	51	1516142	86	1871696	50
492131	56	504290	51	1588175	56	1918016	94
492575	25	504862	56	1588176	52, 56	1918082	94
492577	25	1278022	49	1588698	16	1918652	52
492578	25	1278023	49	1588700	86	1918802	26, 54
492622	56	1278118	49	1588756	52, 56	1918803	26, 54
492623	56	1278201	25	1588908	86	1918804	54
492697	49	1278498	25	1693797	86	1918805	54
492703	49	1278627	56	1693800	86	1918806	26, 54
492782	56	1278632	56	1754074	52, 56	1918807	55
492783	56	1278997	52	1754122	86	1918808	55
501473	52	1374503	49	1754136	56	1918809	26, 54
501818	56	1374547	25	1754137	56	1918810	55
502249	56	1374674	25	1754138	49	1918811	55
502259	56	1457019	25	1754462	52	1918930	92
502418	52	1457628	52	1754515	92	1985006	94
502631	56	1457630	56	1754516	92	1985040	53
502656	56	1515269	86	1754517	92	1985041	53
502862	56	1515270	86	1754603	51, 52	1985162	96
503304	56	1515567	86	1754636	56	1985212	93
503337	56	1515568	86	1754765	53	2064431	56
503705	49	1515569	86	1754766	53	2064540	49
		1515570	86	1754767	25, 53	5492576	25
		1515571	86	1754768	53	5502871	25
		1515572	86	1754845	49	6374548	25
		1515573	86	1828352	96	6374671	25

Americas

Argentina – Buenos Aires
Phone: +54-11-4733-2200
Fax: +54-11-4733-2211

Brasil – São Paulo
Phone: +55-11-2103-6000
Fax: +55-11-2103-6030

Chile – Santiago
Phone: +56-2-345-0361
Fax: +56-2-223-1477

Canada – Toronto
Phone: +905-475-6222
Fax: +905-474-5520
Product Information Center:
Phone: +905-470-4425
Fax: +905-474-5525

Colombia – Bogota
Phone: +57-1-319-8959
Fax: +57-1-319-8960

Mexico & Central America –
Mexico City
Phone: +52-55-1106-0814
+01-800-733-8926
Fax: +52-55-1106-0901

**For Latin/South American
Countries not shown**
Phone: +55-11-2103-6000
Fax: +54-11-4733-2083

United States
Harrisburg, PA
Phone: +1-717-564-0100
Fax: +1-717-986-7575
Product Information Center:
Phone: +1-800-522-6752
Fax: +1-717-986-7575

Troy, MI
Phone: +1-248-273-3359
Fax: +1-248-273-3322

Asia/Pacific

Australia – Sydney
Phone: +61-2-9554-2600
Fax: +61-2-9502-2556
Product Information Center:
Phone: +61-2-9840-8200
Fax: +61-2-9634-6188

India – Bangalore
Phone: +91-80-285-40800
Fax: +91-80-285-40820

Indonesia – Jakarta
Phone: +65-6482-0311
Fax: +65-6482-1012

Japan – Kawasaki, Kanagawa
Phone: +81-44-844-8111
Fax: +81-44-812-3207
Product Information Center:
Phone: +81-44-844-8013
Fax: +81-44-812-3200

Korea – Seoul
Phone: +82-2-3415-4500
Fax: +82-2-3486-3810

Malaysia – Selangor
Phone: +60-3-7805-3055
Fax: +60-3-7805-3066

New Zealand – Auckland
Phone: +64-9-634-4580
Fax: +64-9-634-4586

Philippines – Makati City
Phone: +632-848-0171
Fax: +632-867-8661

People's Republic of China
Hong Kong
Phone: +852-2735-1628
Fax: +852-2735-0243

Shanghai
Phone: +86-400-820-6015
Fax: +86-21-2407-1599

Singapore – Singapore
Phone: +65-6482-0311
Fax: +65-6482-1012

Taiwan – Taipei
Phone: +886-2-8768-2788
Fax: +886-2-8768-2268

Thailand – Bangkok
Phone: +66-2-955-0500
Fax: +66-2-955-0505

Vietnam – Ho Chi Minh City
Phone: +84-8-930-5546
Fax: +84-8-930-3443

Europe/Middle East/Africa

Austria – Vienna
Phone: +43-1-905-60-0
Fax: +43-1-905-60-1333
Product Information Center:
Phone: +43-1-905-60-1249
Fax: +43-1-905-60-1251

Belarus – Minsk
Phone: +375 17 237 47 94
Fax: +375 17 237 47 94

Belgium – Kessel-Lo
Phone: +32-16-352-300
Fax: +32-16-352-355

Bulgaria – Sofia
Phone: +359-2-971-2152
Fax: +359-2-971-2153

Czech Republic and Slovakia
Czech Republic – Kurim
Phone: +420-541-162-111
Fax: +420-541-162-223
Product Information Center:
Phone: +420-541-162-113
Fax: +420-541-162-132

Denmark – Glostrup
Phone: +45-43-48-04-00
Fax: +45-43-44-14-14

Egypt – Cairo
Phone: +202-419-2334
Fax: +202-417-7647

Estonia – Tartu
Phone: +372-5138-274
Fax: +372-7400-779

Finland – Helsinki
Phone: +358-95-12-34-20
Fax: +358-95-12-34-250

France – Cergy-Pontoise Cedex
Phone: +33-1-3420-8888
Fax: +33-1-3420-8600
Product Information Center:
Phone: +33-1-3420-8686
Fax: +33-1-3420-8623

France Export Divisions –
Cergy-Pontoise Cedex
Phone: +33-1-3420-8804
Fax: +33-1-3420-8699

Germany – Bensheim
Phone: +49-6251-133-0
Fax: +49-6251-133-1600
Product Information Center:
Phone: +49-6251-133-1999
Fax: +49-6251-133-1988

Greece – Athens
Phone: +30-210-9370-
396/397
Fax: +30-210-9370-655

Hungary – Budapest
Phone: +36-1-289-1000
Fax: +36-1-289-1010
Product Information Center:
Phone: +36-1-289-1016
Fax: +36-1-289-1017

Ireland – Dublin
Phone: +353-1-866-5612
Fax: +353-1-866-5714

Israel – Petach-Tikva
Phone: +972-3-929-0999
Fax: +972-3-919-1088

Italy – Collegno (Torino)
Phone: +39-011-4012-111
Fax: +39-011-4031-116
Product Information Center:
Phone: +39-011-4012-428
Fax: +39-011-40-287-428

Lithuania and Latvia
Lithuania – Vilnius
Phone: +370-5-213-1402
Fax: +370-5-213-1403
Product Information Center:
Phone: +370-5-211-3016
Fax: +370-5-213-1403

Netherlands – 's-
Hertogenbosch
Phone: +31-73-6246-246
Fax: +31-73-6212-365
Product Information Center:
Phone: +31-73-6246-999
Fax: +31-73-6246-998

Norway – Nesbru
Phone: +47-66-77-88-50
Fax: +47-66-77-88-55

Poland – Warsaw
Phone: +48-22-4576-700
Fax: +48-22-4576-720
Product Information Center:
Phone: +48-22-4576-704
Fax: +48-22-4576-720

Romania – Bucharest
Phone: +40-21-311-3479/3596
Fax: +40-21-312-0574

Russia – Moscow
Phone: +7-495-790-7902
Fax: +7-495-721-1893
Product Information Center:
Phone: +7-495-790-7902-404
Fax: +7-495-790-7902-401

Russia – St. Petersburg
Phone: +7-812-718-8192
Fax: +7-812-718-8193

Slovenia – Ljubljana
Phone: +386-1561-3270
Fax: +386-1561-3240

South Africa – Port Elizabeth
Phone: +27-41-503-4500
Fax: +27-41-581-0440

Spain – Barcelona
Phone: +34-93-291-0330
Fax: +34-93-201-7879

Sweden – Upplands Väsby
Phone: +46-8-50-72-50-00
Fax: +46-8-50-72-50-01

Switzerland – Steinach
Phone: +41-71-447-0447
Fax: +41-71-447-0444

Turkey – Istanbul
Phone: +90-212-281-8181/2/3
+90-212-282-
5130/5430
Fax: +90-212-281-8184

Ukraine – Kiev
Phone: +380-44-206-2265
Fax: +380-44-206-2264
Product Information Center:
Phone: +380-44-206-2265
Fax: +380-44-206-2264

United Kingdom –
Stanmore, Middlesex
Phone: +44-8706-080208
Fax: +44-208-954-6234
Product Information Center:
Freephone (UK only):
0800-267-666
Phone: +44-8706-080208
Fax: +44-208-420-8095

Tyco Electronics Corporation
Harrisburg, PA

www.tycoelectronics.com

1307895-5M-CIS-LUG-FP-4-10

