

CAT. NO. & DIMENSIONS

REVISIONS				
REV	DESCRIPTION	ECN	BY	DATE
A	Released	J05-0079	H.T	'05/2/18

NO. OF CONTACTS (n)	CAT. NO.		DIMENSIONS (NOTE1)	
	RIGHT ANGLE TYPE	STRAIGHT TYPE	A ± 0.3	B ± 0.3
4	SLW4R-1C7LF	SLW4S-1C7LF	10.2	5.2
5	SLW5R-1C7LF	SLW5S-1C7LF	11.2	6.2
6	SLW6R-1C7LF	SLW6S-1C7LF	12.2	7.2
7	SLW7R-1C7LF	SLW7S-1C7LF	13.2	8.2
8	SLW8R-1C7LF	SLW8S-1C7LF	14.2	9.2
9	SLW9R-1C7LF	SLW9S-1C7LF	15.2	10.2
10	SLW10R-1C7LF	SLW10S-1C7LF	16.2	11.2
11	SLW11R-1C7LF	SLW11S-1C7LF	17.2	12.2
12	SLW12R-1C7LF	SLW12S-1C7LF	18.2	13.2
13	SLW13R-1C7LF	SLW13S-1C7LF	19.2	14.2
14	SLW14R-1C7LF	SLW14S-1C7LF	20.2	15.2
15	SLW15R-1C7LF	SLW15S-1C7LF	21.2	16.2
16	SLW16R-1C7LF	SLW16S-1C7LF	22.2	17.2
17	SLW17R-1C7LF	SLW17S-1C7LF	23.2	18.2
18	SLW18R-1C7LF	SLW18S-1C7LF	24.2	19.2
19	SLW19R-1C7LF	SLW19S-1C7LF	25.2	20.2
20	SLW20R-1C7LF	SLW20S-1C7LF	26.2	21.2
21	SLW21R-1C7LF	SLW21S-1C7LF	27.2	22.2
22	SLW22R-1C7LF	SLW22S-1C7LF	28.2	23.2
23	SLW23R-1C7LF	SLW23S-1C7LF	29.2	24.2
24	SLW24R-1C7LF	SLW24S-1C7LF	30.2	25.2
25	SLW25R-1C7LF	SLW25S-1C7LF	31.2	26.2
26	SLW26R-1C7LF	SLW26S-1C7LF	32.2	27.2
27	SLW27R-1C7LF	SLW27S-1C7LF	33.2	28.2
28	SLW28R-1C7LF	SLW28S-1C7LF	34.2	29.2
29	SLW29R-1C7LF	SLW29S-1C7LF	35.2	30.2
30	SLW30R-1C7LF	SLW30S-1C7LF	36.2	31.2

CAT. NO. SLW (n) R - 1C7 LF

SERIES NAME \_\_\_\_\_

NO. OF CONTACTS \_\_\_\_\_

R: RIGHT ANGLE TYPE



S: STRAIGHT TYPE

VARIATION \_\_\_\_\_

LEAD FREE \_\_\_\_\_

NOTE

1. SEE PART DRAWINGS FOR DIMENSIONS A,B.

SHEET INDEX	ISSUE	A																		
	SH NO.	1																		
TOLERANCES UNLESS OTHERWISE SPECIFIED	DR	A. KOBAYASHI		DATE	05/2/18	CUSTOMER COPY		TITLE												
	ENGR	<i>H. Kobayashi</i>						CAT NO. TABLE FOR												
	CHK	<i>H. Kobayashi</i>		DATE	2/18/05	THIRD ANGLE PROJ		1mm SPACING CONNECTOR												
	APPT	<i>M. Kobayashi</i>		DATE	2/18/05	UNIT	MM	(Cat. No. SLW__R/S-1C7LF)												
ANGLES								PRODUCT FAMILY										58JF	CODE	JP
DO NOT SCALE PRINT		THIS INFORMATION IS CONFIDENTIAL AND IS DISCLOSED TO YOU ON CONDITION THAT NO FURTHER DISCLOSURE IS MADE BY YOU TO OTHER THAN FCI PERSONNEL WITHOUT WRITTEN AUTHORIZATION FROM FCI JAPAN K.K.										SCALE	A	DWG. NO.	JSA 96300	REV	A	SHEET	OF	
DF-140A REV A																				



TOLERANCES  
UNLESS OTHERWISE SPECIFIED: ± 0.3

REVISIONS				
REV	DESCRIPTION	ECN	BY	DATE
A	Released	J05-0079	H.T	'05/2/18
B	Added note	J05-0501	H.T	'05/8/4

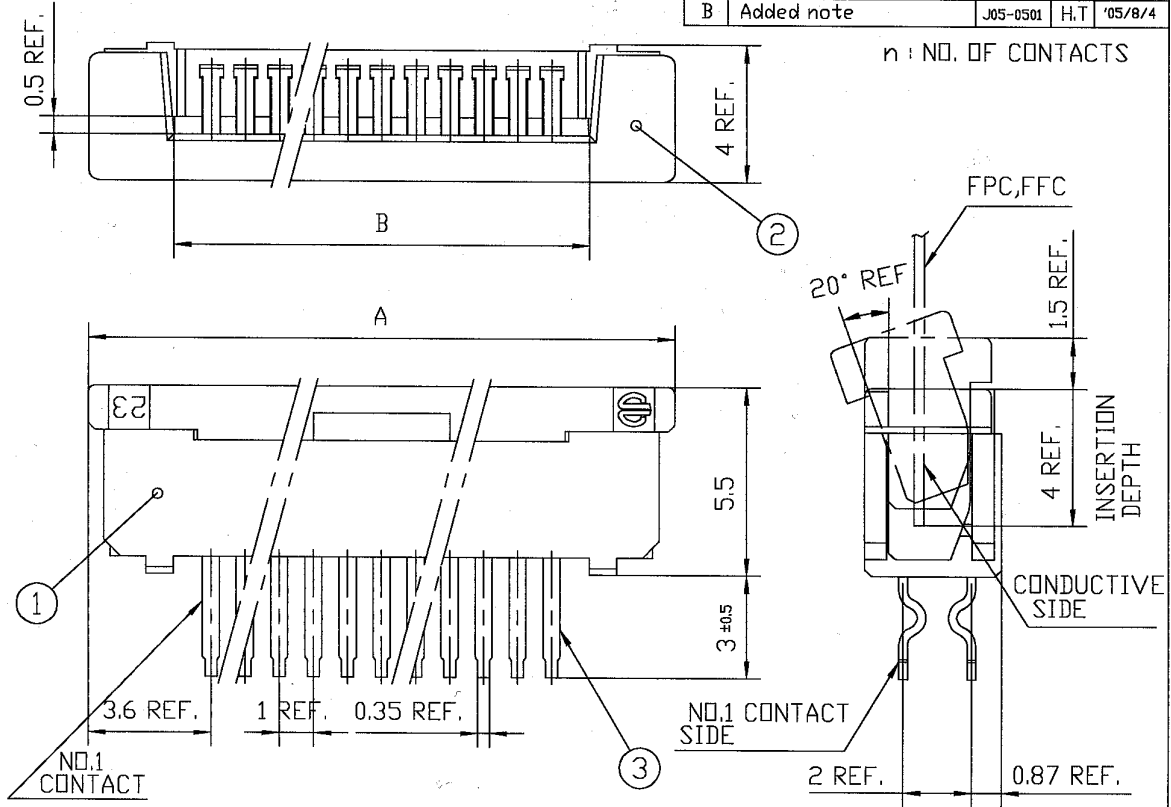

PT.NO.	PARTS NAME	MATERIAL	Q'TY	NOTE
1	HOUSING	NYLON RESIN GLASS REINFORCED (UL94V-0)	1	COLOR : BLACK
2	SLIDER		1	
3	CONTACT	PHOSPHOR BRONZE	n	PLATING : MATTE PURE TIN (LEAD FREE)

RECOMMENDED PC BOARD  
THICKNESS : 0.8~1.6  
HOLE PATTERN (COMPONENT SIDE)

THIS PRODUCT MEETS EUROPEAN UNION DIRECTIVES AND OTHER COUNTRY REGULATIONS AS DESCRIBED IN GS-22-008.

THE HOUSING WILL WITHSTAND EXPOSURE TO 260 DEGREE C PEAK TEMPERATURE FOR 10 SECONDS IN A WAVE SOLDER APPLICATION WITH A 1.6mm MINIMUM THICK CIRCUIT BOARD.

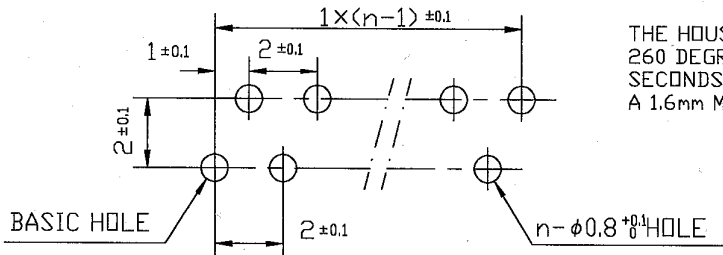

SHEET INDEX		ISSUE	B					A FCI	
		SH NO.	1					TITLE	
TOLERANCES UNLESS OTHERWISE SPECIFIED		DR	<i>[Signature]</i>	DATE	8/4/05	CUSTOMER COPY		1mm SPACING CONNECTOR (Cat. No. SLW__S-1C7LF)	
LINEAR		ENGR	<i>[Signature]</i>	DATE	8/4/05	THIRD ANGLE PROJ		PRODUCT FAMILY 58JF	
ANGLES		CHK	<i>[Signature]</i>	DATE	8/4/05	UNIT $\frac{MM}{INCH}$		CODE JP	
DO NOT SCALE PRINT		APPR	<i>[Signature]</i>	DATE	8/4/05	SCALE		SIZE	DWG. NO.
DF-140A REV A		THIS INFORMATION IS CONFIDENTIAL AND IS DISCLOSED TO YOU ON CONDITION THAT NO FURTHER DISCLOSURE IS MADE BY YOU TO OTHER THAN FCI PERSONNEL WITHOUT WRITTEN AUTHORIZATION FROM FCI JAPAN K.K.				-		A	JSA 96301
SC-SLW03 JSA96300						REV		B	SHEET OF

REVISIONS				
REV	DESCRIPTION	ECN	BY	DATE
AA	Changed form	J05-0079	H.T	2/18/05

RECOMMENDED CABLE (FPC)

n : NO. OF CONDUCTOR

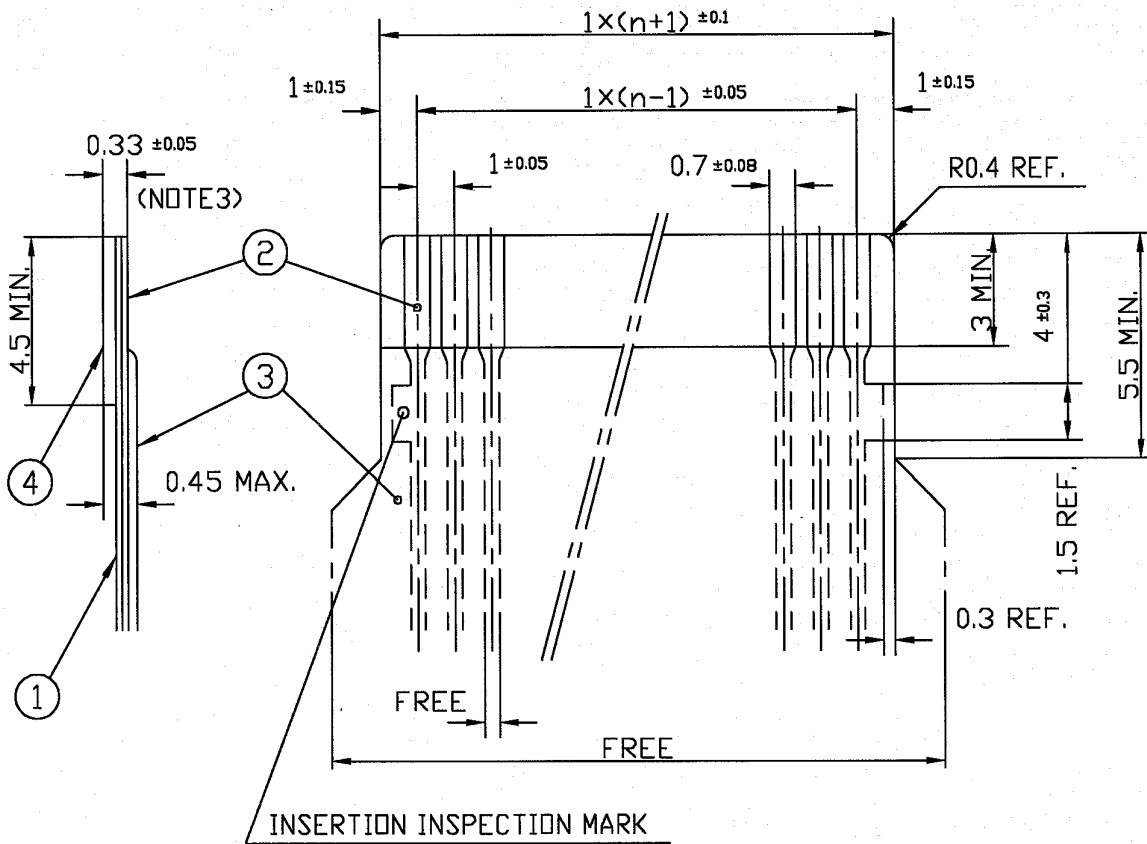

PT. NO.	PARTS NAME	MATERIAL	THICKNESS (μm)
1	BASE FILM	POLYIMIDE OR POLYESTER OR EQUAL	25
2	CONDUCTOR	COPPER FOIL (PLATING : SOLDER 1μm MIN.)	35
3	OVERLAY	POLYIMIDE OR POLYESTER OR EQUAL	—
4	SUPPORTING TAPE	POLYESTER OR POLYIMIDE OR EQUAL	188

- NOTES
1. NO BURR AT EACH PORTION.
  2. NO PEELING IN COMMON USE.
  3. TOTAL THICKNESS LIMIT OF EACH MATERIAL (INCLUDING ADHESIVE AGENT) IS SPECIFIED.

SHEET INDEX	ISSUE	AA									
	SH NO.	1									
TOLERANCES UNLESS OTHERWISE SPECIFIED		DR	A. KOBAYASHI	DATE	05/2/18	CUSTOMER COPY	TITLE				
LINEAR		ENGR	<i>[Signature]</i>		2/18/05		RECOMMENDED CABLE				
		CHK	<i>[Signature]</i>		2/18/05		(Cat. No. SLW__R/S-__)				
		APPD	<i>[Signature]</i>		2/18/05		PRODUCT FAMILY 58JF				
ANGLES						UNIT	MM	CODE	JP		
DO NOT SCALE PRINT	THIS INFORMATION IS CONFIDENTIAL AND IS DISCLOSED TO YOU ON CONDITION THAT NO FURTHER DISCLOSURE IS MADE BY YOU TO OTHER THAN FCI PERSONNEL WITHOUT WRITTEN AUTHORIZATION FROM FCI JAPAN K.K.						SCALE	SIZE	DWG. NO.	REV	SHEET
DF-140A REV A							-	A	JSA 91648	AA	OF

REVISIONS				
REV	DESCRIPTION	ECN	BY	DATE
AA	Changed form.	J05-0079	H.T	2/18/05

RECOMMENDED CABLE (FFC)

n : NO. OF CONDUCTOR

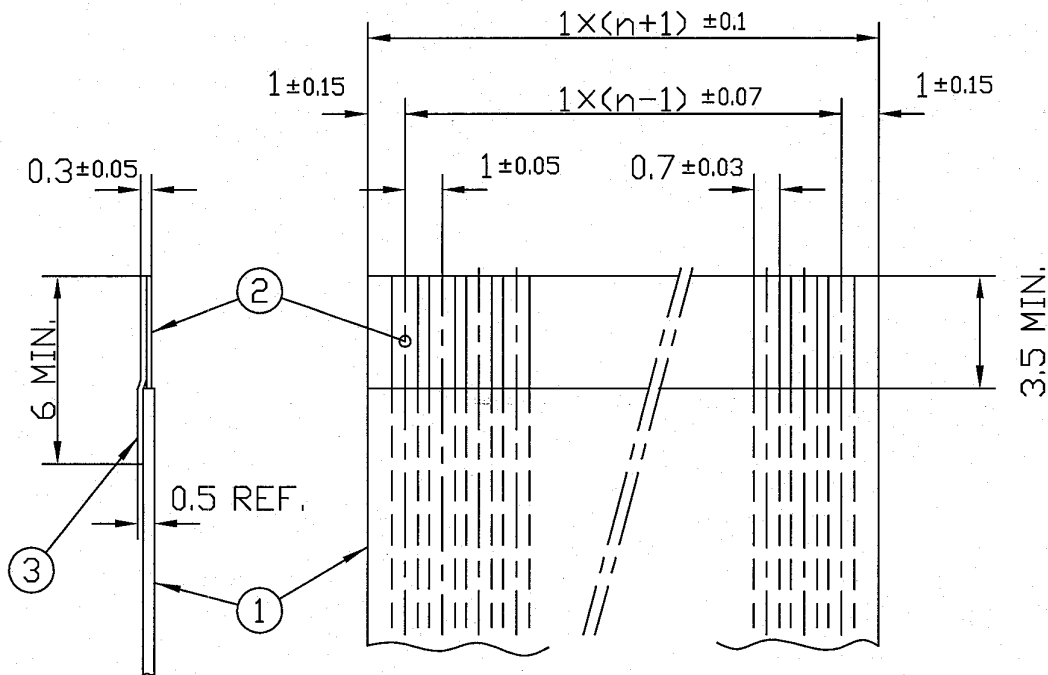

PT. NO.	PARTS NAME	MATERIAL	NOTE
1	INSULATOR	FLAME RESISTING POLYESTER OR EQUAL	_____
2	CONDUCTOR	COPPER FOIL	PLATING : TIN OR SOLDER 1μm MIN.
3	SUPPORTING TAPE	FLAME RESISTING POLYESTER OR EQUAL	_____

- NOTES
1. NO BURR AT EACH PORTION.
  2. NO PEELING IN COMMON USE.

SHEET INDEX	ISSUE	AA									
	SH NO.	1									
TOLERANCES UNLESS OTHERWISE SPECIFIED		DR	A. KOBAYASHI	DATE	2/18/05	CUSTOMER COPY	TITLE				
LINEAR	±0.3	ENGR	<i>[Signature]</i>	2/18/05		RECOMMENDED CABLE					
		CHK	<i>[Signature]</i>	2/18/05		(Cat. No. SLW__R/S-__)					
		APPD	<i>[Signature]</i>	2/18/05		PRODUCT FAMILY 58JF					
ANGLES					UNIT	MM	INCH	CODE JP			
DO NOT SCALE PRINT	THIS INFORMATION IS CONFIDENTIAL AND IS DISCLOSED TO YOU ON CONDITION THAT NO FURTHER DISCLOSURE IS MADE BY YOU TO OTHER THAN FCI PERSONNEL WITHOUT WRITTEN AUTHORIZATION FROM FCI JAPAN K.K.					SCALE	SIZE	DWG. NO.	REV	SHEET	
DF-140A REV A						-	A	JSA 91649	AA	0F	

CAT. NO. & DIMENSIONS

REVISIONS				
REV	DESCRIPTION	ECN	BY	DATE
A	Released	J05-0079	H.T	'05/2/15

NO. OF CONTACTS (n)	CAT. NO.		DIMENSIONS (NOTE1)	
	RIGHT ANGLE TYPE	STRAIGHT TYPE	A ± 0.3	B ± 0.3
4	SLW 4 R-5C7LF	SLW 4 S-5C7LF	10.2	5.2
5	SLW 5 R-5C7LF	SLW 5 S-5C7LF	11.2	6.2
6	SLW 6 R-5C7LF	SLW 6 S-5C7LF	12.2	7.2
7	SLW 7 R-5C7LF	SLW 7 S-5C7LF	13.2	8.2
8	SLW 8 R-5C7LF	SLW 8 S-5C7LF	14.2	9.2
9	SLW 9 R-5C7LF	SLW 9 S-5C7LF	15.2	10.2
10	SLW 10 R-5C7LF	SLW 10 S-5C7LF	16.2	11.2
11	SLW 11 R-5C7LF	SLW 11 S-5C7LF	17.2	12.2
12	SLW 12 R-5C7LF	SLW 12 S-5C7LF	18.2	13.2
13	SLW 13 R-5C7LF	SLW 13 S-5C7LF	19.2	14.2
14	SLW 14 R-5C7LF	SLW 14 S-5C7LF	20.2	15.2
15	SLW 15 R-5C7LF	SLW 15 S-5C7LF	21.2	16.2
16	SLW 16 R-5C7LF	SLW 16 S-5C7LF	22.2	17.2
17	SLW 17 R-5C7LF	SLW 17 S-5C7LF	23.2	18.2
18	SLW 18 R-5C7LF	SLW 18 S-5C7LF	24.2	19.2
19	SLW 19 R-5C7LF	SLW 19 S-5C7LF	25.2	20.2
20	SLW 20 R-5C7LF	SLW 20 S-5C7LF	26.2	21.2
21	SLW 21 R-5C7LF	SLW 21 S-5C7LF	27.2	22.2
22	SLW 22 R-5C7LF	SLW 22 S-5C7LF	28.2	23.2
23	SLW 23 R-5C7LF	SLW 23 S-5C7LF	29.2	24.2
24	SLW 24 R-5C7LF	SLW 24 S-5C7LF	30.2	25.2
25	SLW 25 R-5C7LF	SLW 25 S-5C7LF	31.2	26.2
26	SLW 26 R-5C7LF	SLW 26 S-5C7LF	32.2	27.2
27	SLW 27 R-5C7LF	SLW 27 S-5C7LF	33.2	28.2
28	SLW 28 R-5C7LF	SLW 28 S-5C7LF	34.2	29.2
29	SLW 29 R-5C7LF	SLW 29 S-5C7LF	35.2	30.2
30	SLW 30 R-5C7LF	SLW 30 S-5C7LF	36.2	31.2

CAT. NO. SLW (n) R - 5C7 LF

SERIES NAME \_\_\_\_\_

NO. OF CONTACTS \_\_\_\_\_

R : RIGHT ANGLE TYPE

S : STRAIGHT TYPE

VARIATION \_\_\_\_\_

LEAD FREE \_\_\_\_\_

NOTE

1. SEE PART DRAWINGS FOR DIMENSIONS A,B.

SHEET INDEX	ISSUE	A											
	SH NO.	1											
TOLERANCES UNLESS OTHERWISE SPECIFIED		DR	A. KOBAYASHI	DATE	05/2/18	CUSTOMER COPY		TITLE CAT NO. TABLE FOR 1mm SPACING CONNECTOR (Cat. No. SLW__R/S-5C7LF)					
LINEAR		ENGR	<i>[Signature]</i>	DATE	1/18/05	THIRD ANGLE PROJ		PRODUCT FAMILY 58JF					
		CHK	<i>[Signature]</i>	DATE	2/18/05	UNIT MM		CODE JP					
ANGLES		APPD	<i>[Signature]</i>	DATE	7/19/05	UNIT INCH		SCALE SIZE DWG. NO. REV SHEET					
DD NOT SCALE PRINT		THIS INFORMATION IS CONFIDENTIAL AND IS DISCLOSED TO YOU ON CONDITION THAT NO FURTHER DISCLOSURE IS MADE BY YOU TO OTHER THAN FCI PERSONNEL WITHOUT WRITTEN AUTHORIZATION FROM FCI JAPAN K.K.						- A		JSA 96303		A	OF







