

0.5mm Pitch
SERIES

6210/6260

0.5mmピッチ RA SMT 下接点 スライドロック
0.5mmPitch RA SMT Bottom contact Slide lock

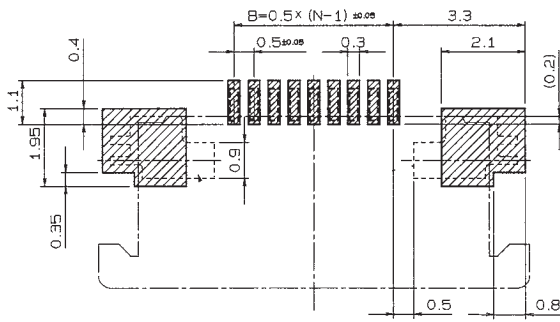
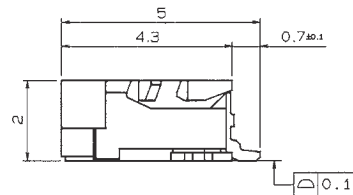
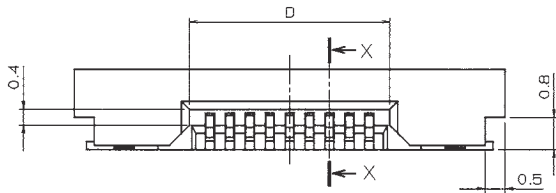
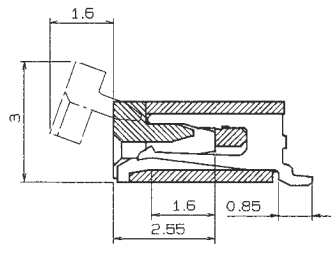
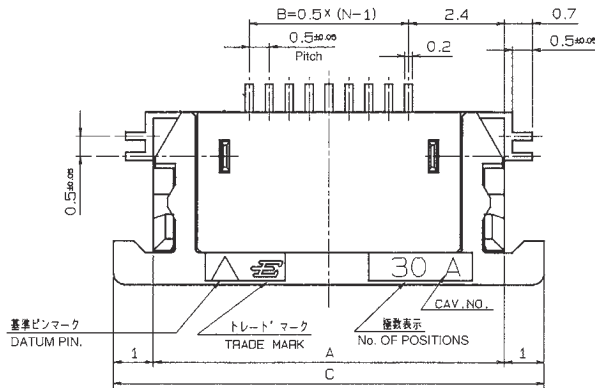

推奨基板取付寸法 (コネクタ搭載側)
MOUNTING LAYOUT (CONN. MOUNTING SIDE)

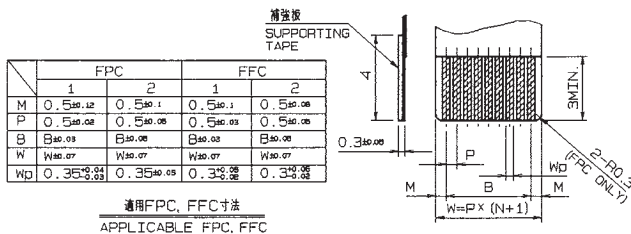

極数 NO. OF POS.	A	B	C	D
5	6.8	2.0	8.8	3.1
6	7.3	2.5	9.3	3.6
7	7.8	3.0	9.8	4.1
8	8.3	3.5	10.3	4.6
9	8.8	4.0	10.8	5.1
10	9.3	4.5	11.3	5.6
11	9.8	5.0	11.8	6.1
12	10.3	5.5	12.3	6.6
13	10.8	6.0	12.8	7.1
14	11.3	6.5	13.3	7.6
15	11.8	7.0	13.8	8.1
16	12.3	7.5	14.3	8.6
17	12.8	8.0	14.8	9.1
18	13.3	8.5	15.3	9.6
19	13.8	9.0	15.8	10.1
20	14.3	9.5	16.3	10.6
21	14.8	10.0	16.8	11.1
22	15.3	10.5	17.3	11.6
23	15.8	11.0	17.8	12.1
24	16.3	11.5	18.3	12.6
25	16.8	12.0	18.8	13.1
26	17.3	12.5	19.3	13.6
27	17.8	13.0	19.8	14.1
28	18.3	13.5	20.3	14.6
29	18.8	14.0	20.8	15.1
30	19.3	14.5	21.3	15.6
33	20.8	16.0	22.8	17.1
34	21.3	16.5	23.3	17.6
36	22.3	17.5	24.3	18.6
40	24.3	19.5	26.3	20.6

注文コード ORDERING CODE
08 6210 OXX 340 800+

RoHS 対応品
RoHS Compliant Product

スズ銅めっき Sn-Cu Plated

極数 NUMBER OF POSITIONS

注文コード ORDERING CODE
08 6260 OXX 340 XXX+

RoHS 対応品
RoHS Compliant Product

800+ : スズ銅めっき Sn-Cu Plated (C/Ag type)
829+ : 金めっき Au Plated

極数 NUMBER OF POSITIONS

生産対応可能極数については、営業部にご確認願います。
Feel free to contact our sales department for available numbers of positions.

0.5mm Pitch
SERIES

6210/6260

エンボス梱包品
Tape and Reel Package

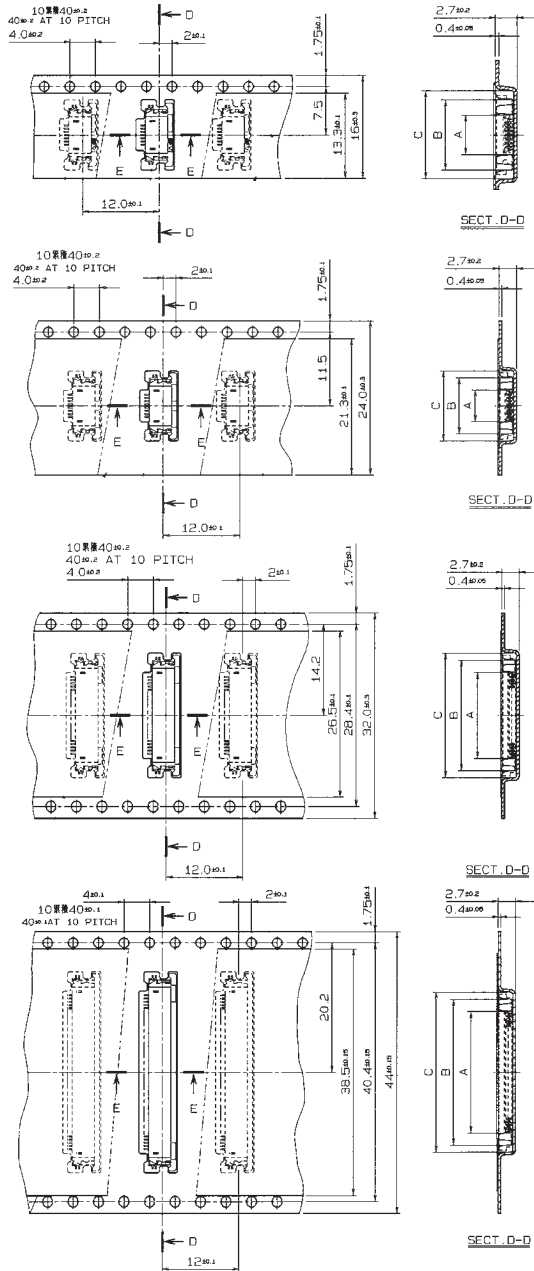

極数 NO.OF POS.	A	B	C
5	3.4	7.2	9.4
6	3.9	7.7	9.9

極数 NO.OF POS.	A	B	C
7	4.4	8.2	10.4
8	4.9	8.7	10.9
9	5.4	9.2	11.4
10	5.9	9.7	11.9
11	6.4	10.2	12.4
12	6.9	10.7	12.9
13	7.4	11.2	13.4
14	7.9	11.7	13.9
15	8.4	12.2	14.4
16	8.9	12.7	14.9
17	9.4	13.2	15.4
18	9.9	13.7	15.9
19	10.4	14.2	16.4
20	10.9	14.7	16.9
21	11.4	15.2	17.4
22	11.9	15.7	17.9
23	12.4	16.2	18.4
24	12.9	16.7	18.9

極数 NO.OF POS.	A	B	C
25	13.4	17.2	19.4
26	13.9	17.7	19.9
27	14.4	18.2	20.4
28	14.9	18.7	20.9
29	15.4	19.2	21.4
30	15.9	19.7	21.9

極数 NO.OF POS.	A	B	C
33	17.4	21.2	23.4
34	17.9	21.7	23.9
35	18.4	22.2	24.4
36	18.9	22.7	24.9
38	19.9	23.7	25.9
40	20.9	24.7	26.9

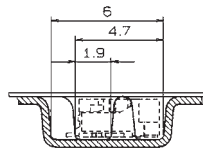

SECT. E-E

生産対応可能極数については、営業部にご確認願います。
Feel free to contact our sales department for available numbers of positions.

注文コード ORDERING CODE
08 6210 OXX 340 800+

RoHS 対応品
RoHS Compliant Product

スズ銅めっき Sn-Cu Plated

極数 NUMBER OF POSITIONS

注文コード ORDERING CODE
08 6260 OXX 340 XXX+

RoHS 対応品
RoHS Compliant Product

800+ : スズ銅めっき Sn-Cu Plated (C/Ag type)
829+ : 金めっき Au Plated

極数 NUMBER OF POSITIONS

梱包数量 2000個/リール
PACKING QUANTITY : 2000/Reel