

Wire to Board Connectors

Dynamic Series Connectors/D-5200 Series

D-5200M—Modular Type

Mating Dimensions

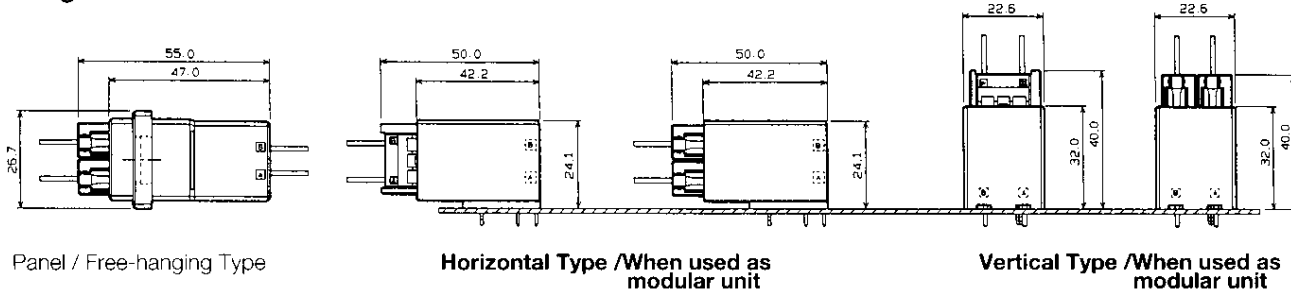

Receptacle Housing

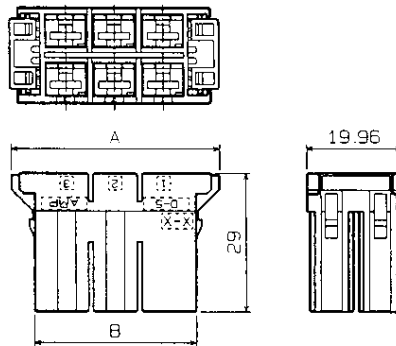
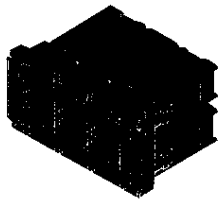

No. of Position	Part Number of Receptacle Housing	Dimensions	
		A	B
4	□-917807-2	33.36	23.76
6	□-917807-3	43.52	33.92

Tab Housing

Panel Type

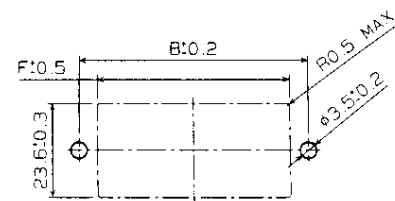
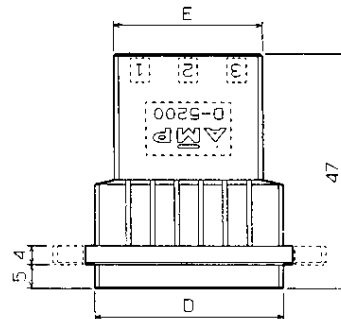
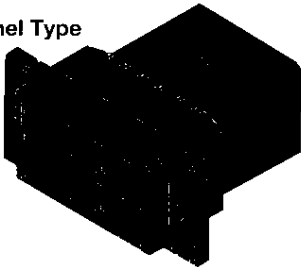

Panel Cutout

When mounting panel from the front, apply clamping torque of less than 49N.

Free-hanging Type

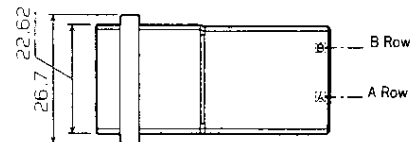
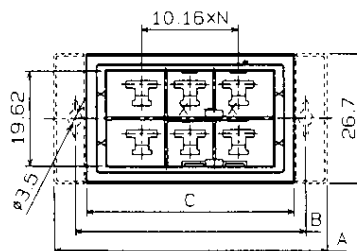
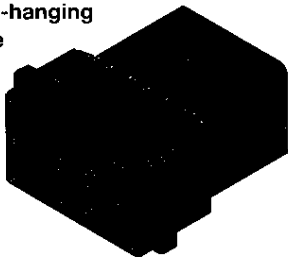

No. of Pos.	Part Number of Tab Housing		Dimensions					
	Panel Type	Free-hanging Type	A	B	C	D	E	F
4	□-917809-2	□-917808-2	47	38	33.44	29.36	21.11	30.40
6	□-917809-3	□-917808-3	57	48	43.60	39.52	31.27	40.50