



Level V IDC Connectors, .125 x .125 [3.18 x 3.18] Centerline

Product Facts

- Termination of discrete wire sizes 26-22 AWG [0.12-0.3 mm²] as well as jacketed cable and bonded ribbon cable (conductors separated)
- Connectors stackable end-to-end and side-to-side on .125 [3.18] centers
- Connectors preloaded with insulation displacement receptacle contacts
- Contact design employs dual cantilever beams, redundant insulation displacement slots, built-in post stop and wire support crimp
- Copper alloy contacts are duplex plated
- Snap-on covers with or without cable tie paddles
- Full line of mass termination tooling offers lowest installed costs for most production needs
- Recognized under the Component Program of Underwriters Laboratories Inc.,  File No. E28476
- Certified by Canadian Standards Association,  File No. LR 7189

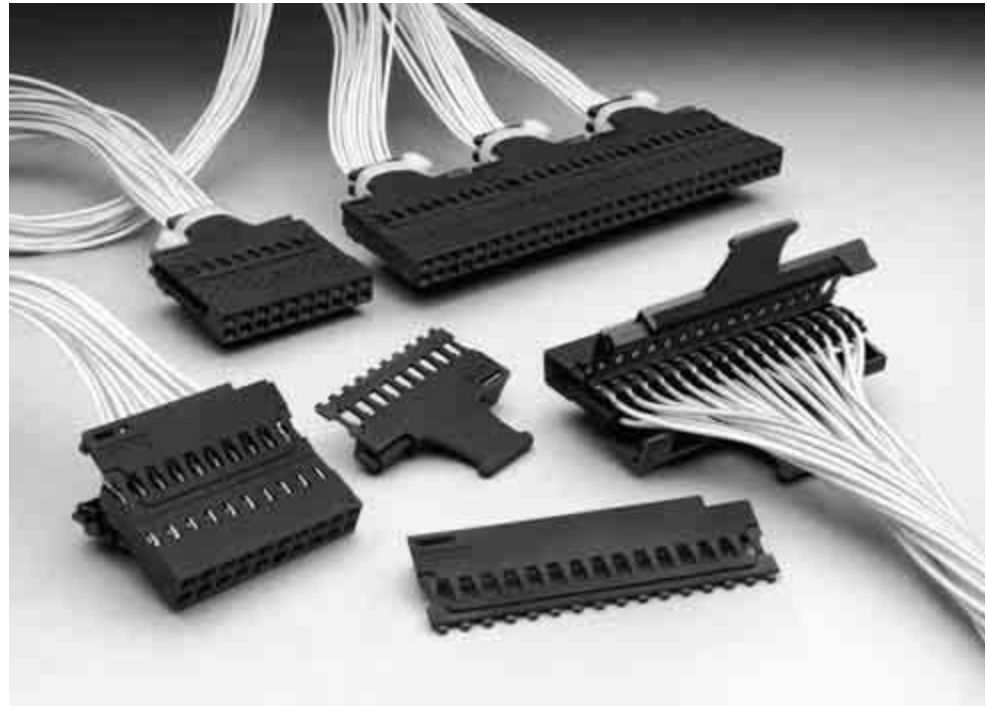

AMPMODU Level V IDC connectors provide cost effective discrete wire connections that are compatible with today's telecommunications packaging techniques. These connectors are designed to mate with .025 [0.64] sq. posts on .125 x .125 [3.18 x 3.18] centers and are comprised of double-row housings preloaded with insulation displacement receptacle contacts, snap-on hermaphroditic covers, and a full line of mass termination tooling to meet virtually every production need. For modular flexibility, connectors can be stacked end-to-end or side-to-side, maintaining a .125 x .125 [3.18 x 3.18] centerline spacing.

Covers can be furnished with and without a cable tie paddle. The covers are simply snapped onto a housing after the connector has been terminated.

The receptacle contacts feature the Tyco Electronics insulation displacement crimp technique for achieving top quality, low cost terminations. These contacts employ dual cantilever beams for redundant interface with a mating post, an integral post stop to limit post mating depth and protect the crimp termination, and a wire support (strain relief) crimp to prevent accidental wire pull-out. The contacts are made of high conductivity copper alloy and are duplex plated.

Performance Characteristics

Contact Current Rating — 3 amperes

Termination Resistance — 12 milliohms (max.)

Durability — Ref. Product Specification 108-25028 (Interconnection System, Insulation Displacement Connector, IDC Level)

Application Specification 114-25020 (Interconnection System, IDC Level V, Application of)

Receptacle Assemblies, Double-Row, .125 x .125 [3.18 x 3.18] Centerline

Housings Preloaded with Insulation Displacement Crimp Receptacle Contacts



Material and Finish

Housing — Black thermoplastic, flame retardant

Contacts — Copper alloy, duplex plated .000050 [0.00127] gold on contact area, .000100 [0.00254] min. tin in crimp area, with entire contact underplated .000050 [0.00127] nickel

Note: Preloaded contacts accept max. insulation dia. of .050 [1.27]. The minimum point of contact, as measured from front edge of housing, is .095 [2.41].

Technical Documents — pages 277, 278

Product Specification
108-25028

Application Specification
114-25020

Receptacle assemblies can be stacked end-to-end and side-to-side on .125 x .125 [3.18 x 3.18] centers.

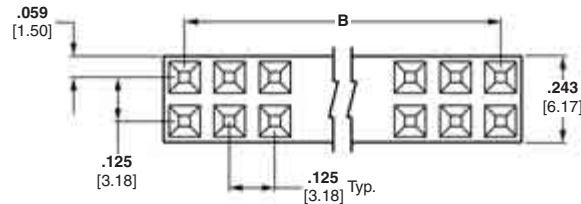
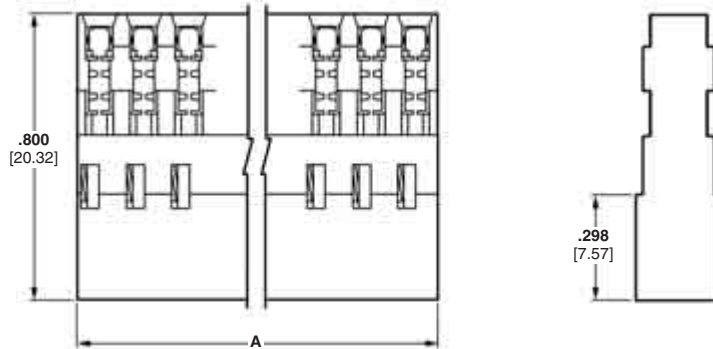

No. of Pos.	Dimensions		Receptacle Assembly (Stamped ¹) for 26-22 AWG [0.12-0.3 mm ²] Wire
	A	B	
8	.493 [12.52]	.375 [9.52]	102935-4
10	.618 [15.70]	.500 [12.70]	102935-6
12	.743 [18.87]	.625 [15.88]	102935-8
16	.993 [25.22]	.875 [22.23]	1-102935-2
20	1.243 [31.57]	1.125 [28.58]	1-102935-6
24	1.493 [37.92]	1.375 [34.93]	1-102935-9
30	1.868 [47.45]	1.750 [44.45]	1-102935-3
32	1.993 [50.62]	1.875 [47.63]	2-102935-8
40	2.493 [63.32]	2.375 [60.33]	3-102935-6

¹White ink stamped, one side—8- thru 12-position with AMP and arrow; 14- and 16-position with AMP, part no., and arrow; 18- thru 40-position with AMP, part no., date code and arrow.

- Notes:**
- Covers for these housings are shown on pages 281 & 282.
 - Termination tooling for these connectors are shown on page 273-275.
 - 14- and 18-position receptacle assemblies, as well as other sizes, can be made available upon request. Consult Tyco Electronics.

Note: All part numbers are RoHS compliant.

Hermaphroditic Covers for Level V IDC Receptacle Assemblies, Double-Row, .125 x .125 [3.18 x 3.18] Centerline

All covers illustrated here and on the following page can be used on the double-row Level V IDC connectors shown on page 280.

Material

Black thermoplastic, flame retardant, 94V-0 rated

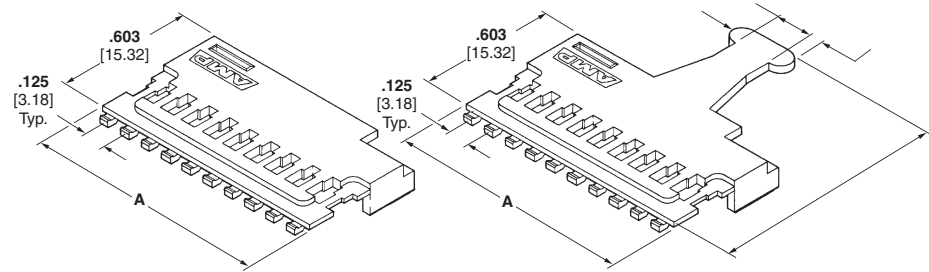

Cover 103056 Series
without Cable Tie Paddle

Cover 103058 Series
with Cable Tie Paddle

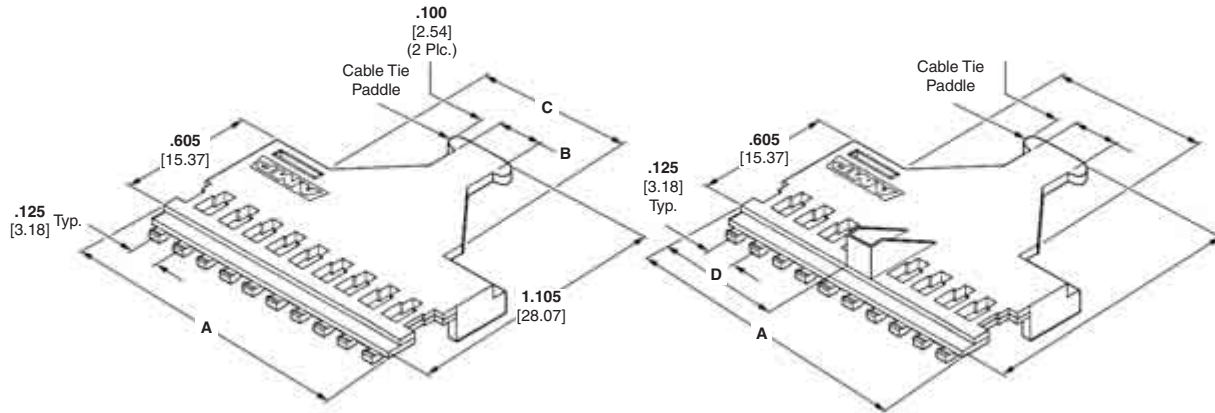

Cover 103349 Series
with Wide Cable Tie Paddle

Cover 103350 Series
with Wide Cable Tie Paddle
and Polarization

No. of Pos. (Housing Size)	Dimensions					Cover Part Nos.			
	A	B	C	D	E	Without Cable Tie Paddle	With Cable Tie Paddle	With Wide Cable Tie Paddle	With Wide Cable Tie Paddle and Polarization
8	.491 [12.47]	.150 [3.81]	.285 [7.24]	.166 [4.22]	.125 [3.18]	—	—	103349-4	103350-4
10	.616 [15.65]	—	—	—	.125 [3.18]	—	103058-3	—	—
12	.741 [18.82]	—	—	—	.200 [5.08]	—	103058-4	—	—
16	.991 [25.17]	.300 [7.62]	.592 [15.04]	.416 [10.57]	—	—	—	103349-1	103350-1
20	1.241 [31.52]	.300 [7.62]	.592 [15.04]	.541 [13.74]	—	—	—	103349-5	103350-5
24	1.491 [37.87]	—	—	—	.400 [10.16]	1-103056-0	1-103058-0	—	—
32	1.991 [50.57]	.600 [15.24]	1.312 [33.32]	.916 [23.27]	—	—	—	103349-2	103350-2
40	2.491 [63.27]	.750 [19.05]	1.820 [46.23]	1.166 [29.61]	—	—	—	103349-3	103350-3
64	See page 282 for Double Cable Tie Paddle versions.								

Notes: 1. Two hermaphroditic covers of any style can be installed on a double-row connector housing.
2. Other sizes can be made available upon request.

Note: All part numbers are RoHS compliant.

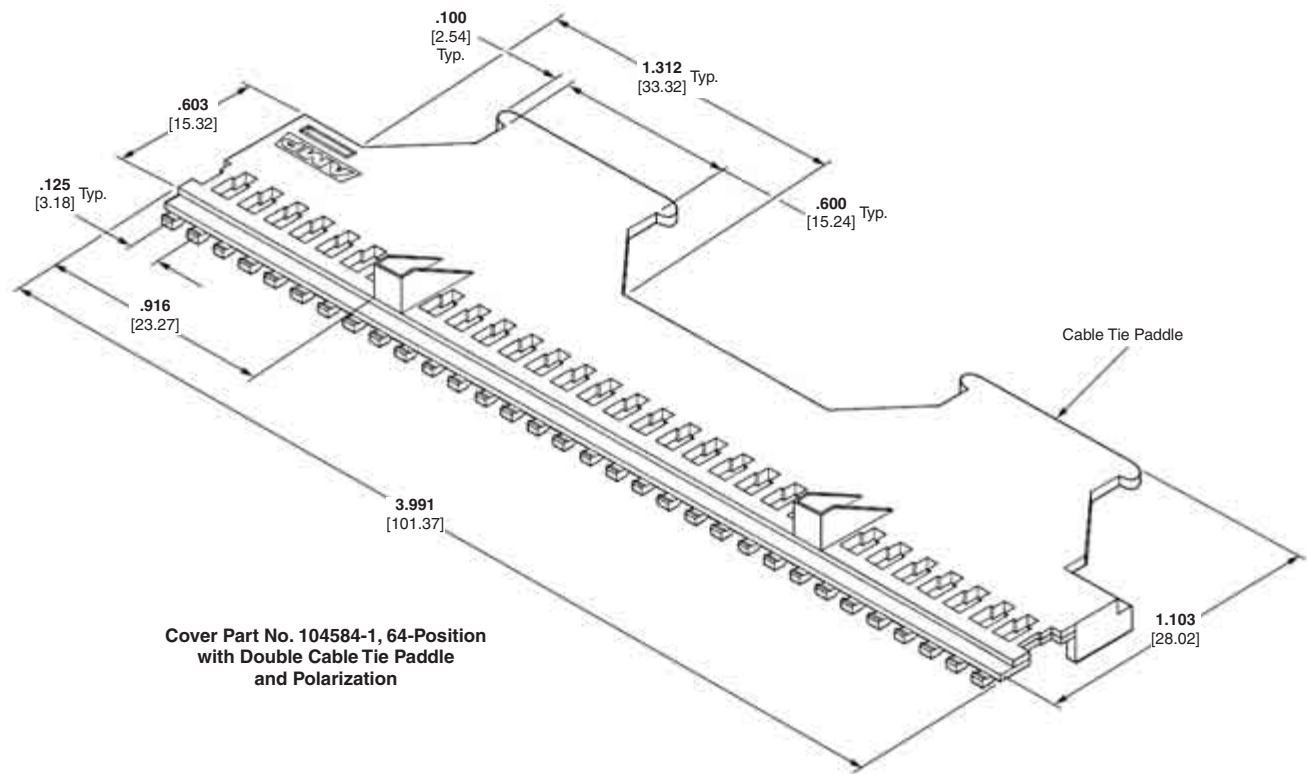
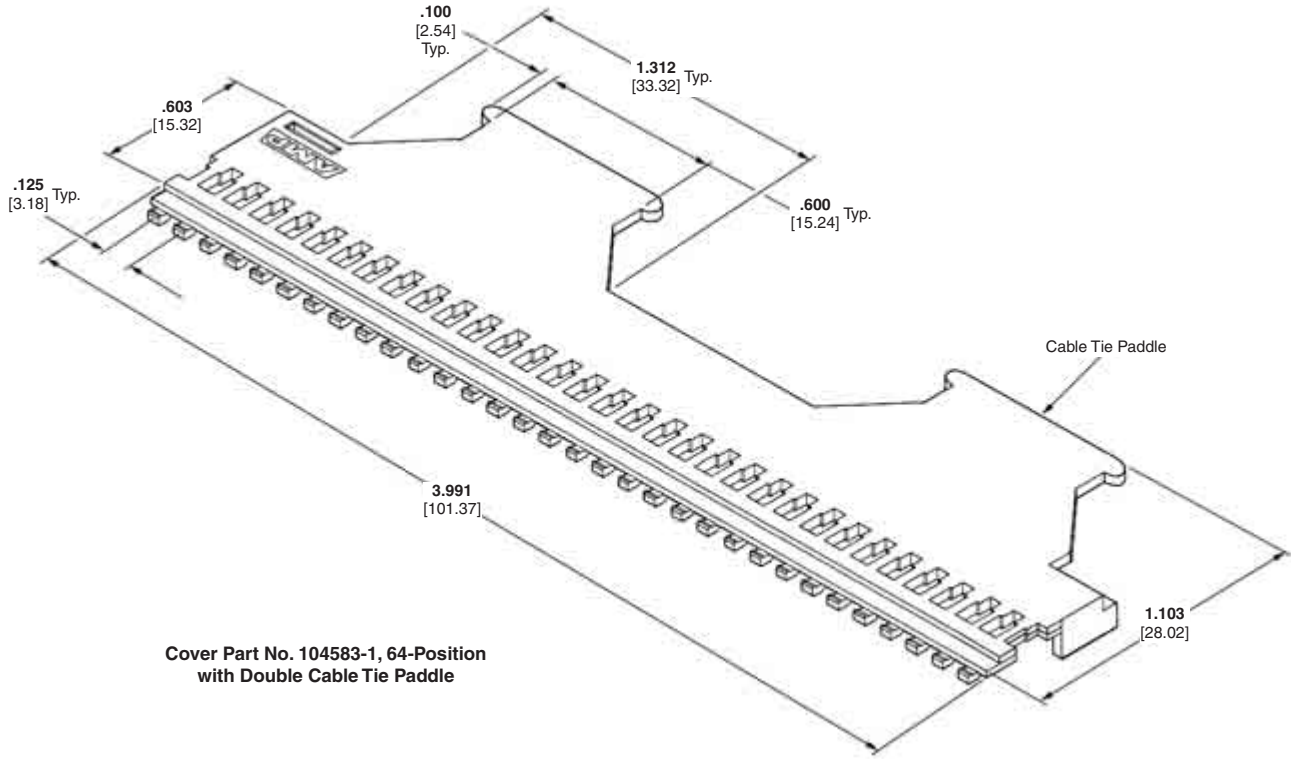

Hermaphroditic Covers for Level V IDC Receptacle Assemblies, Double-Row, .125 x .125 [3.18 x 3.18] Centerline (Continued)



Note: All part numbers are RoHS compliant.

AMPMODU .031 x .062 [0.79 x 1.57] Interconnection System

Product Facts

- Rugged connector system featuring .031 x .062 [0.79 x 1.57] posts with mating receptacles
- Current rating 5 amps max per contact. Varies due to ambient temperature, wire size and duty cycles.
- Available for board-to-board and wire-to-board applications
- Posts available on strip for machine application directly to pc board or in housings for board mounting
- Receptacles available for board mounting or wire crimping
- Contacts available in both tin and gold plating
- Flame retardant thermoplastic housings 94V-0 rated
- Locking Clip contacts available to mate with .031 x .062 [0.79 x 1.57] posts
- Recognized under the Component Program of Underwriters Laboratories Inc.,  File No. E28476
- Certified by Canadian Standards Association,  File No. LR 16455



The .031 x .062 [0.79 x 1.57] interconnection system has served as an industry standard for modular packaging for over three decades. It is a rugged, large scale system designed for board-to-board and board-to-wire or cable applications that has offered millions of reliable interconnections and countless mating cycles. This versatile interconnection system successfully meets the requirements for most modular power supply packaging.

Board mounted receptacles and receptacle assemblies are available in various geometries, offering packaging interconnections that include perpendicular, parallel and stacking

capabilities. Machine applied terminations, through matched application equipment, are geared to virtually any production requirement, assuring the lowest possible applied cost.

Crimp snap-in receptacles for 26-18 AWG [0.12 – 0.9mm²] wire provide excellent discrete wire terminations. Housings for these contacts provide for ease of handling terminations in high density applications.

AMPMODU mating posts are supplied typically as header assemblies. They are available in various sizes to meet the interconnection and packaging requirements of your system. However, in instances where packaging

configurations do not lend themselves to the economies of assemblies, Tyco Electronics can provide for the discrete location of individual posts and receptacles.

If your interconnections require Top Entry, Bottom Entry and/or Side Entry for perpendicular, parallel and stacked configurations, the .031 x .062 [0.79 x 1.57] interconnection system can fulfill your needs with the lowest applied cost through efficient interconnections and supporting application equipment.

AMPMODU .031 x .062 [0.79 x 1.57] Interconnection System (Continued)

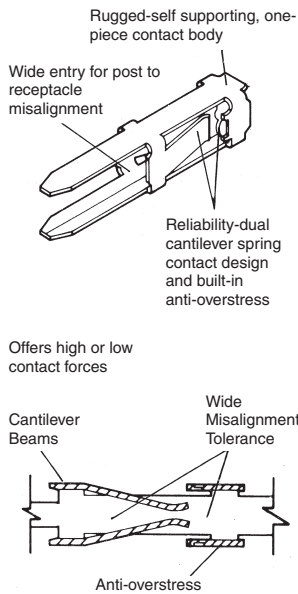
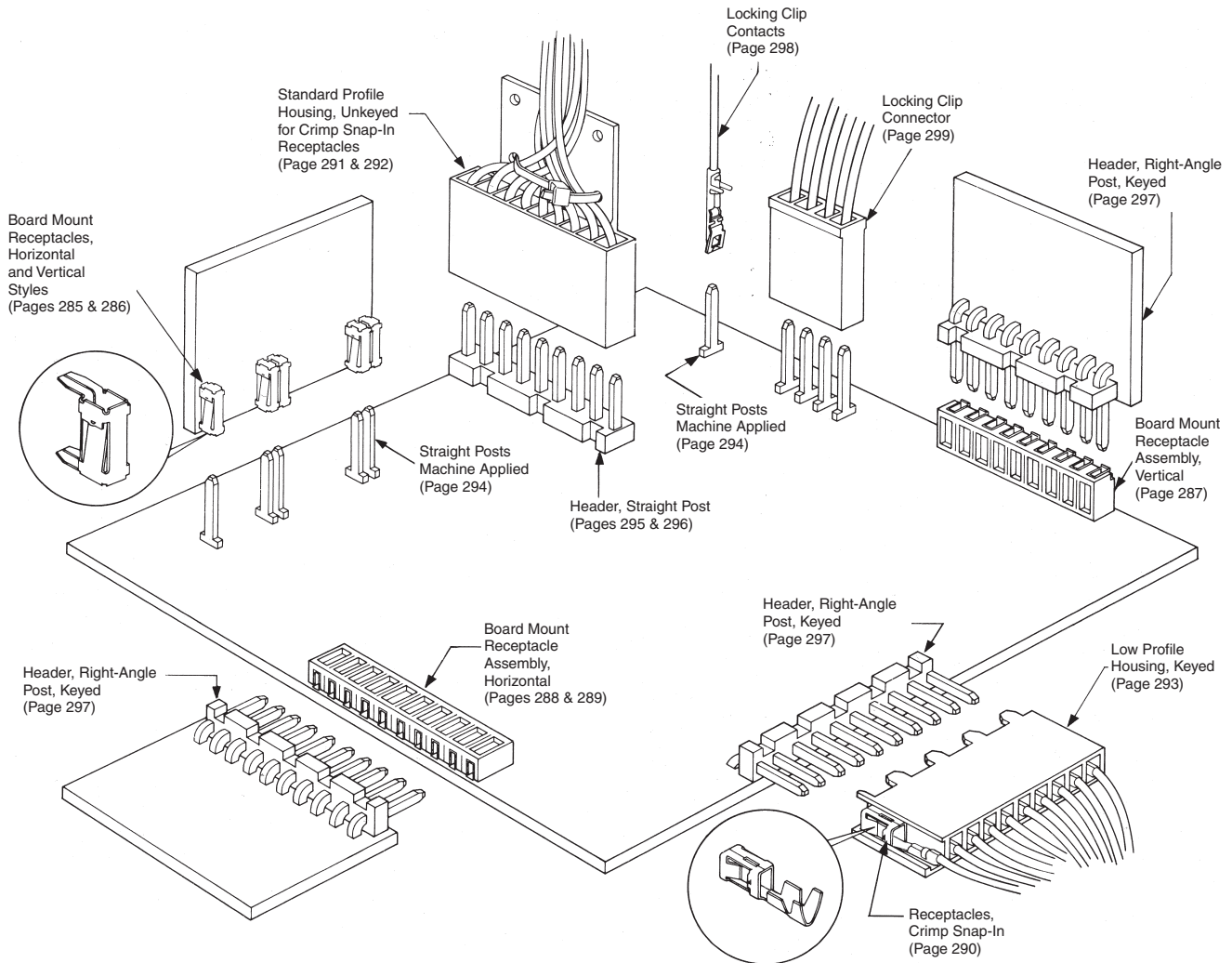

The AMPMODU receptacle cross-section is primarily rectangular, with rounded corners. Two integral cantilever beams contact the mating square or rectangular posts. Deflection of these spring members is limited by anti-overstress and excessive permanent deformation is prevented. This feature allows a wide range of tolerances for misalignment of mating contacts. The configuration of the receptacle completely encloses the spring members preventing damage during handling and assembly and makes the system compatible with automatic application techniques.

This design also permits the use of the receptacles without housings or encapsulation.

Note: Application of a contact lubricant is part of the manufacturing process of all AMPMODU tin-plated crimp products. However, it is not part of the manufacturing process of products that customers will solder, then clean. For these products, Tyco Electronics recommends that customers purchase a contact lubricant. (See application specification 114-25004 for further information.)

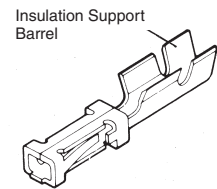

Wire Crimp Receptacle

Mod I Receptacles, Board Mount, .031 x .062 [0.79 x 1.57] Centerline

Vertical and Horizontal Board Mount

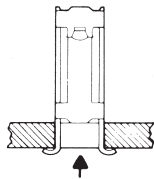

Bottom Post Entry Type A

Top Post Entry Type B

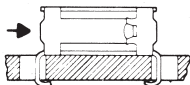
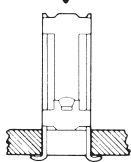

Horizontal Post Entry Type C

Receptacle Styles

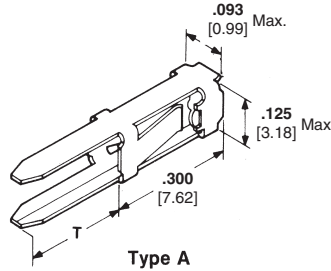

Type A

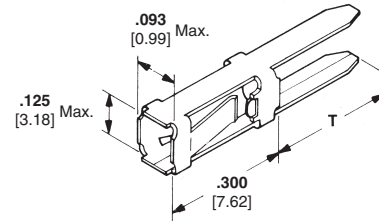

Type B

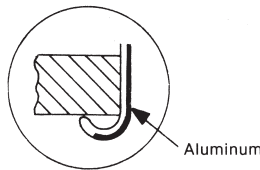

Typical Solder Resist Tab (Type A or B)

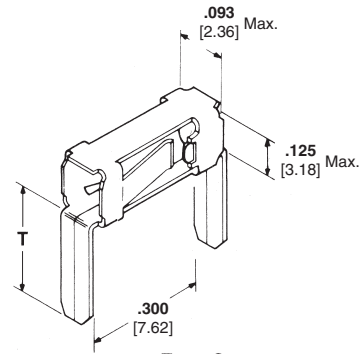

Type C

Related Product Data
Recommended Board Layout for Type C — page 288

- Mates with** —
- Machine Applied Posts** — page 294
- Headers** — pages 295-297
- Application Tooling** — pages 300-304
- Performance Specifications** — page 305
- Technical Documents** — page 305

Recommended Board Layout for Receptacle Assemblies and Individual Receptacles (Type A and B)

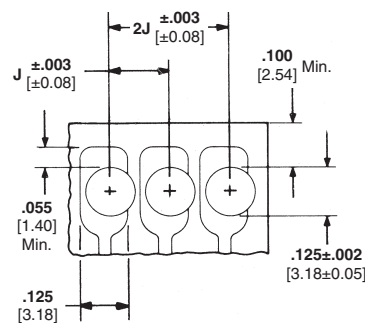

Round Hole (Post Entry Type A or B)

Keying Plug

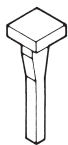

Part No. 86181-2
Use in Board Mount Receptacles

J-Receptacle centers may vary depending on requirements. For individual receptacles, minimum nominal centerline spacing between adjacent receptacles is .150 [3.81]; for receptacle assemblies, centerline spacing between adjacent receptacles is .156 [3.96]. The .003 [0.08] tolerances are not to accumulate over length of board. For solder mask, see Tyco Electronics Instruction Sheet 408-7411.

Note: Drawings depict normal use of the contact in a one or two-sided circuit board. When using plated thru-holes, refer to Tyco Electronics Engineering Report ER-001 and Tyco Electronics Instruction Sheet 408-7411. For solder mask, see Tyco Electronics Instruction Sheet 408-7411.

Note: All part numbers are RoHS compliant.

Mod I Receptacles, Board Mount, .031 x .062 [0.79 x 1.57] Centerline (Continued)

Material and Finish

Copper alloy, plated as follows:

Plating A — Selectively plated .000030 [0.00076] gold on contact area, with gold flash over .000050 [0.00127] nickel on entire contact

Plating B — .000079 [0.00201] min. tin on entire contact

Plating C — (Solder Resist) — .000030 [0.00076] gold over .000050 [0.00127] nickel on contact area, .000500 [0.01270] aluminum on inside area of solder tines; remainder of contact unfinished

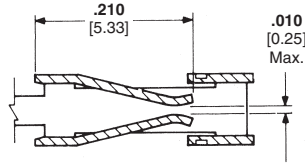

Standard Pressure Receptacle

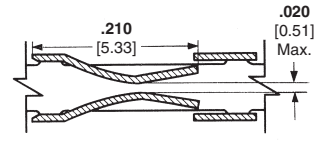

High Pressure Receptacle

Type	Board Thickness Range	Dimension T (Ref. Pg. 285)	Finish	Standard Pressure Part Nos.		High Pressure Part Nos.		Insertion Applicator No. for "U" Frame Machine
				Strip Form	Loose Piece	Strip Form	Loose Piece	
A	.070-.055 [1.78-1.40]	.112 [2.84]	Plating A	86477-2	86480-2	—	—	466376-1
			Plating B	86477-3	—	87316-3	—	466376-1
			Plating C (Solder Resist)	87772-2	—	—	—	466376-1
B	.070-.055 [1.78-1.40]	.112 [2.84]	Plating A	87003-1	87105-1	—	—	466376-1
			Plating B	87003-2	—	—	—	466376-1
			Plating C (Solder Resist)	87774-2	—	—	—	466376-1
C	.103-.055 [2.62-1.40]	.145 [3.68]	Plating A	85487-4	85493-4	86432-8	86434-6	565967-3
			Plating B	85487-3	—	86432-1	86434-1	

Notes: 1. All strip form parts in packaged quantities of 5,000 each.
2. All loose piece parts in packaged quantities of 500 each.

Note: All part numbers are RoHS compliant.

Mod I Receptacle Assemblies, Vertical Board Mount, .031 x .062 [0.79 x 1.57] Centerline

Single Row .156 [3.96] Centerline

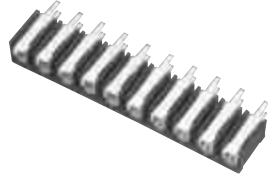

The letter A stamped on contact indicates mating end of receptacle.

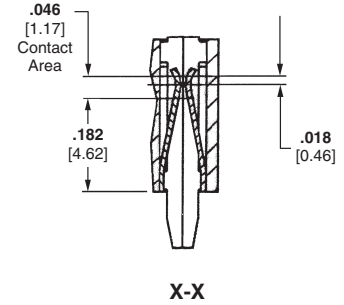
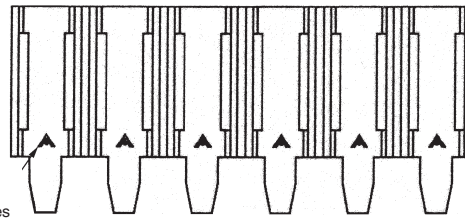

Material and Finish

Housing — Black thermoplastic, 94V-0 rated

Contacts — Copper alloy, plated as follows:

Plating A — Selectively plated .000030 [0.00076] gold on contact area, with gold flash over .000050 [0.00127] nickel on entire contact

Plating B — .000079 [0.00201] min. tin on entire contact

Plating C — (Solder Resist) — .000030 [0.00076] gold over .000050 [0.00127] nickel on contact area, .000500 [0.01270] aluminum on inside area of solder tines; remainder of contact unfinished

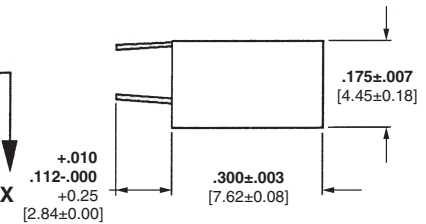
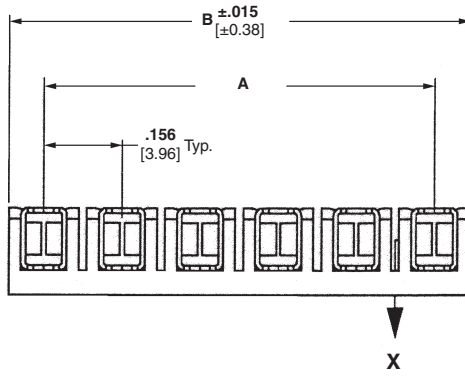

Related Product Data

Recommended Board Layout — page 288

Mates with —

Machine Applied Posts — page 294

Headers — pages 295-297

Performance Specifications — page 305

Technical Documents — page 305

No. of Pos.	Dimensions		Type A				Type B		
	A	B	Standard Pressure		High Pressure	Standard Pressure			
			Plating A	Plating B	Plating C	Plating B	Plating A	Plating B	Plating C
2	.156 [3.96]	.312 [7.92]	87984-2	87983-2	87989-2	87993-2	87986-2	87985-2	87990-2
3	.312 [7.92]	.468 [11.89]	87984-3	87983-3	87989-3	87993-3	87986-3	87985-3	87990-3
4	.468 [11.89]	.624 [15.85]	87984-4	87983-4	87989-4	87993-4	87986-4	87985-4	87990-4
5	.624 [15.85]	.780 [19.81]	87984-5	87983-5	87989-5	87993-5	87986-5	87985-5	87990-5
6	.780 [19.81]	.936 [23.77]	87984-6	87983-6	87989-6	87993-6	87986-6	87985-6	87990-6
7	.936 [23.77]	1.092 [27.74]	87984-7	87983-7	87989-7	87993-7	87986-7	87985-7	87990-7
8	1.092 [27.74]	1.248 [31.70]	87984-8	87983-8	87989-8	87993-8	87986-8	87985-8	87990-8
9	1.248 [31.70]	1.404 [35.66]	87984-9	87983-9	87989-9	87993-9	87986-9	87985-9	87990-9
10	1.404 [35.66]	1.560 [39.62]	1-87984-0	1-87983-0	1-87989-0	1-87993-0	1-87986-0	1-87985-0	1-87990-0
11	1.560 [39.62]	1.716 [43.59]	1-87984-1	1-87983-1	1-87989-1	1-87993-1	1-87986-1	1-87985-1	1-87990-1
12	1.716 [43.59]	1.872 [47.55]	1-87984-2	1-87983-2	1-87989-2	1-87993-2	1-87986-2	1-87985-2	1-87990-2
13	1.872 [47.55]	2.028 [51.51]	1-87984-3	1-87983-3	1-87989-3	1-87993-3	1-87986-3	1-87985-3	1-87990-3
14	2.028 [51.51]	2.184 [55.47]	1-87984-4	1-87983-4	1-87989-4	1-87993-4	1-87986-4	1-87985-4	1-87990-4
15	2.184 [55.47]	2.340 [59.44]	1-87984-5	1-87983-5	1-87989-5	1-87993-5	1-87986-5	1-87985-5	1-87990-5
16	2.340 [59.44]	2.496 [63.40]	1-87984-6	1-87983-6	1-87989-6	1-87993-6	1-87986-6	1-87985-6	1-87990-6
17	2.496 [63.40]	2.652 [67.36]	1-87984-7	1-87983-7	1-87989-7	1-87993-7	1-87986-7	1-87985-7	1-87990-7
18	2.652 [67.36]	2.808 [71.32]	1-87984-8	1-87983-8	1-87989-8	1-87993-8	1-87986-8	1-87985-8	1-87990-8
19	2.808 [71.32]	2.964 [75.29]	1-87984-9	1-87983-9	1-87989-9	1-87993-9	1-87986-9	1-87985-9	1-87990-9
20	2.964 [75.29]	3.120 [79.25]	2-87984-0	2-87983-0	2-87989-0	2-87993-0	2-87986-0	2-87985-0	2-87990-0

Keying Plug

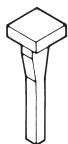

Part No. 86181-2
(Use in Board Mount Receptacles)

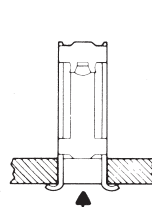

Post Entry Type A

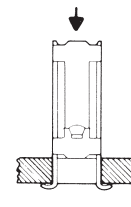

Post Entry Type B

Note: All part numbers are RoHS compliant.

Mod I Receptacle Assemblies, Horizontal Board Mount, .031 x .062 [0.79 x 1.57] Centerline

Single Row .156 [3.96] Centers

Material and Finish

Housing — Black thermoplastic, 94V-0 rated

Contacts — Copper alloy, plated as follows:

Plating A — Selectively plated .000030 [0.00076] gold contact area, with gold flash over .000050 [0.00127] nickel on entire contact

Plating B — .000079 [0.00201] min. tin on entire contact

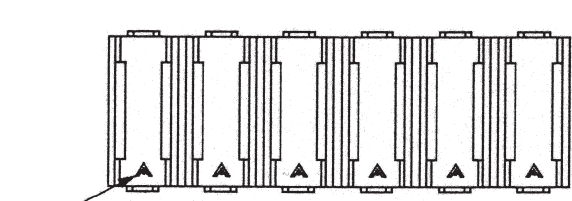
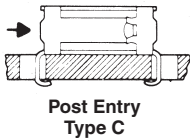

The letter A stamped on contact indicates mating end of receptacle.

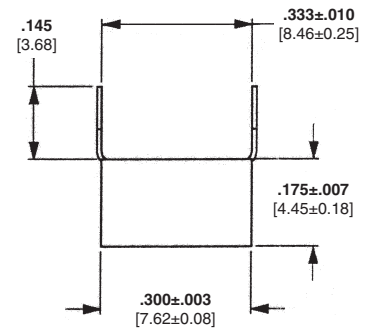
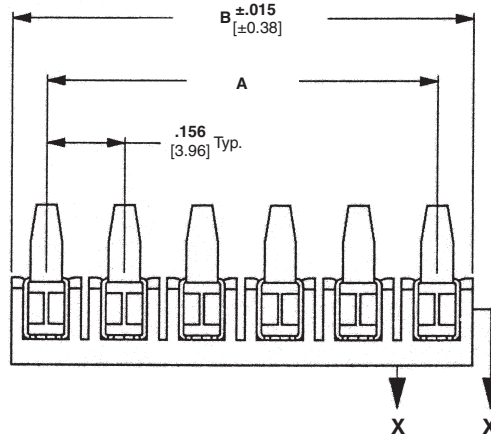
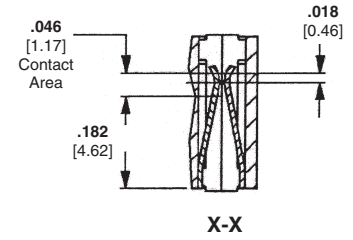

Related Product Data

- Mates with —
- Machine Applied Posts — page 294
- Headers — pages 295-297
- Performance Specifications — page 305
- Technical Documents — page 305

Recommended Board Layouts for Receptacle Assemblies and Individual Receptacles (Type C)

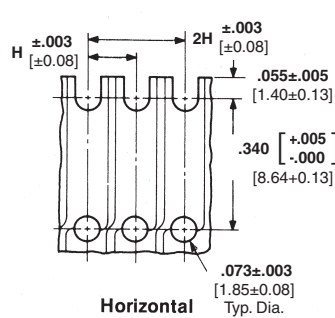

This configuration recommended for use with machine applied posts or headers with a .405 [10.29] minimum mating end post length.*

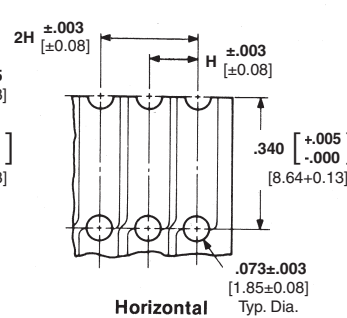

This configuration recommended for use with machine applied posts or headers with a .345 [18.76] minimum mating end post length.*

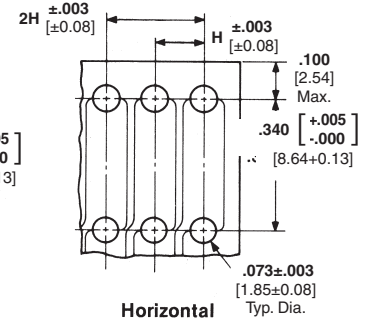

This configuration recommended for use with machine applied posts or headers with a .500 [12.70] minimum mating end post length.*

Keying Plug

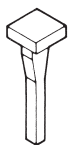

Part No. 86181-2
(Use in Board Mount Receptacles)

The mating post length is depicted by the A dimension on page 294 (machine applied posts) and the C dimension on pages 295-297 (headers).

H-Receptacle centers may vary depending on requirements. For individual receptacles, minimum nominal centerline spacing between adjacent receptacles is .125 [3.18] for receptacle assemblies, centerline spacing between adjacent receptacles is .156 [3.96]. The .003 [0.08] tolerances are not to accumulate over length of board.

Note: All part numbers are RoHS compliant.

**Mod I Receptacle Assemblies, Horizontal Board Mount,
 .031 x .062 [0.79 x 1.57] Centerline** (Continued)

No. of Pos.	Dimensions		Standard Pressure		High Pressure
	A	B	Plating A	Plating B	Plating B
2	.156 [3.96]	.312 [7.92]	87988-2	87987-2	87995-2
3	.312 [7.92]	.468 [11.89]	87988-3	87987-3	87995-3
4	.468 [11.89]	.624 [15.85]	87988-4	87987-4	87995-4
5	.624 [15.85]	.780 [19.81]	87988-5	87987-5	87995-5
6	.780 [19.81]	.936 [23.77]	87988-6	87987-6	87995-6
7	.936 [23.77]	1.092 [27.74]	87988-7	87987-7	87995-7
8	1.092 [27.74]	1.248 [31.70]	87988-8	87987-8	87995-8
9	1.248 [31.70]	1.404 [35.66]	87988-9	87987-9	87995-9
10	1.404 [35.66]	1.560 [39.62]	1-87988-0	1-87987-0	1-87995-0
11	1.560 [39.62]	1.716 [43.59]	1-87988-1	1-87987-1	1-87995-1
12	1.716 [43.59]	1.872 [47.55]	1-87988-2	1-87987-2	1-87995-2
13	1.872 [47.54]	2.028 [51.51]	1-87988-3	1-87987-3	1-87995-3
14	2.028 [51.51]	2.184 [55.47]	1-87988-4	1-87987-4	1-87995-4
15	2.184 [55.47]	2.340 [59.44]	1-87988-5	1-87987-5	1-87995-5
16	2.340 [59.44]	2.496 [63.40]	1-87988-6	1-87987-6	1-87995-6
17	2.496 [63.40]	2.652 [67.36]	1-87988-7	1-87987-7	1-87995-7
18	2.652 [67.36]	2.808 [71.32]	1-87988-8	1-87987-8	1-87995-8
19	2.808 [71.32]	2.964 [75.29]	1-87988-9	1-87987-9	1-87995-9
20	2.964 [75.29]	3.120 [79.25]	2-87988-0	2-87987-0	2-87995-0

Note: All part numbers are RoHS compliant.

**Mod I Receptacles, Crimp Snap-In (Wire Applied),
.031 x .062 [0.79 x 1.57] Centerline**

Material and Finish

Copper alloy, plated as follows:
Plating A — Selectively plated .000030 [0.00076] gold on contact area, with gold flash over .000050 [0.00127] nickel on entire contact
Plating B — .000016 [0.00041] min. tin on entire contact

Related Product Data

- Housings used in** — pages 291-293
- Mate with Machine Applied Posts** — page 294
- Headers** — pages 295-297
- Application Tooling** — page 300-304
- Performance Specification** — page 305
- Technical Documents** — page 305

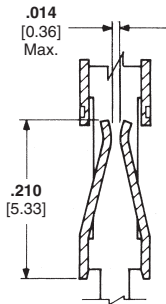
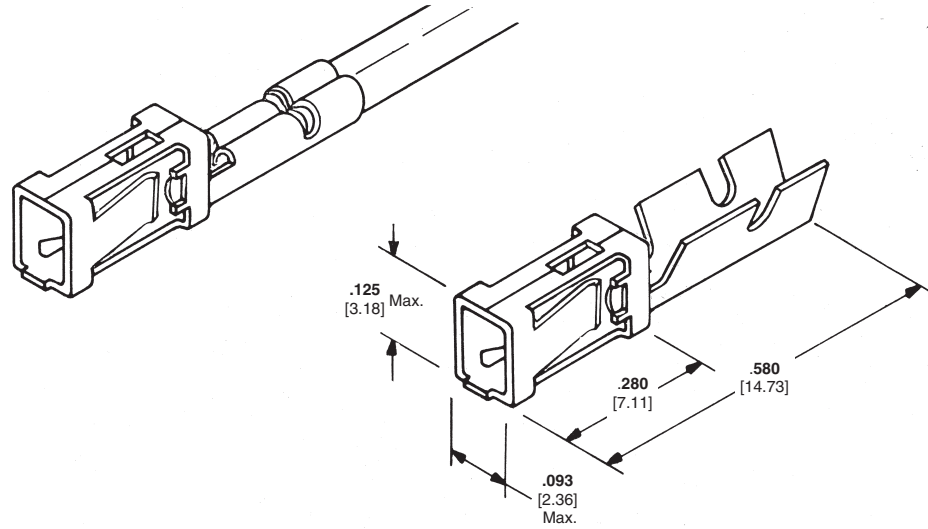

Standard Pressure Receptacle

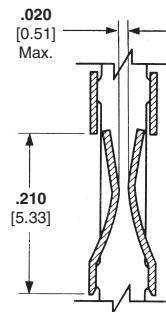

High Pressure Receptacle



Extraction Tool Part No. 843473-1
Part Instruction Sheet 408-9451

Wire Size Range AWG [mm ²]	Ins. Dia. Range	Finish	Standard Pressure			
			Strip Form		Loose Piece	
			Packaged Quantities	Part Nos.	Packaged Quantities	Part Nos.
22-18 [0.3-0.9]	.051-.090 [1.30-2.29]	Plating A	5,000	102099-2	500	102103-2
		Plating B	5,000	102099-5	500	102103-3

Wire Size Range AWG [mm ²]	Applicator (Standard Pressure)			Premium CERTI-CRIMP Hand Tool Part Number
	Part Number	Type	Used With Machine	
22-18 [0.3-0.9]	466764-3	HDM	Model "G" (AMP-O-LECTRIC)	90274-2
	466764-2	HDM	Model "K" (AMP-O-LECTRIC)	
	466764-1	HDM	CLS IV+ (AMPOMATOR)	
	466937-1	SCA	Stripper-Crimper (AMP-O-MATIC)	

AMP-O-LECTRIC KII Machine. Applicators also available for AMPOMATOR Lead Making Machines and Stripper/Crimper Machines. Consult Tyco Electronics.

Wire Size Range AWG [mm ²]	Ins. Dia. Range	Finish	High Pressure			
			Strip Form		Loose Piece	
			Packaged Quantities	Part Nos.	Packaged Quantities	Part Nos.
22-18 [0.3-0.9]	.051-.090 [1.30-2.29]	Plating A	5,000	102100-2	500	102104-2
		Plating B	5,000	102100-5	500	102104-3
26-22 [0.12-0.4]	0.42-.073 [1.07-1.85]	Plating A	5,000	102102-2	500	102106-2
		Plating B	5,000	102102-5	500	102106-3

Wire Size Range AWG [mm ²]	Applicator (High Pressure)			Premium CERTI-CRIMP Hand Tool Part Number
	Part Number	Type	Used With Machine	
22-18 [0.3-0.9]	466764-3	HDM	Model "G" (AMP-O-LECTRIC)	90274-2
	466764-2	HDM	Model "K" (AMP-O-LECTRIC)	
	466764-1	HDM	CLS IV+ (AMPOMATOR)	
	466937-1	SCA	Stripper-Crimper (AMP-O-MATIC)	
26-22 [0.12-0.4]	466763-2	HDM	Model "K" (AMP-O-LECTRIC)	90328-1
	466763-1	HDM	CLS IV+ (AMPOMATOR)	

AMP-O-LECTRIC KII Machine. Applicators also available for AMPOMATOR Lead Making Machines and Stripper/Crimper Machines. Consult Tyco Electronics.

Note: All part numbers are RoHS compliant.

**Mod I Receptacle Housings, Standard Profile, Unkeyed,
.031 x .062 [0.79 x 1.57] Centerline**

**Single Row, .156 [3.96]
Centers, Without Strain
Relief**

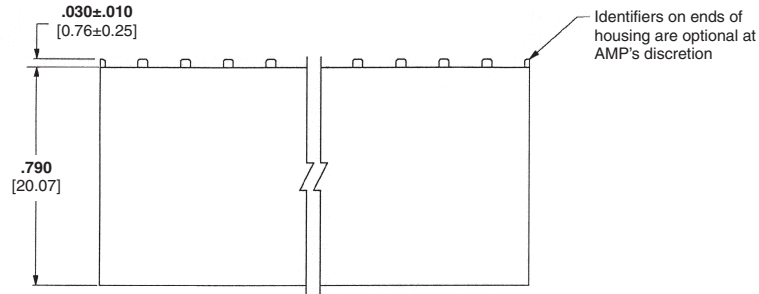
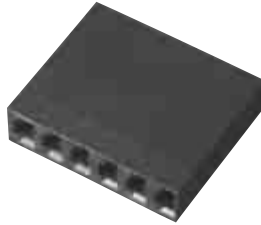

Material

Black thermoplastic, flame retardant,
94V-0 rated

Related Product Data

Contacts used with — page 290

Mate with —

Machine Applied Posts — page 294

Headers — pages 295-297

Performance Specifications —
page 305

Technical Documents —

page 305

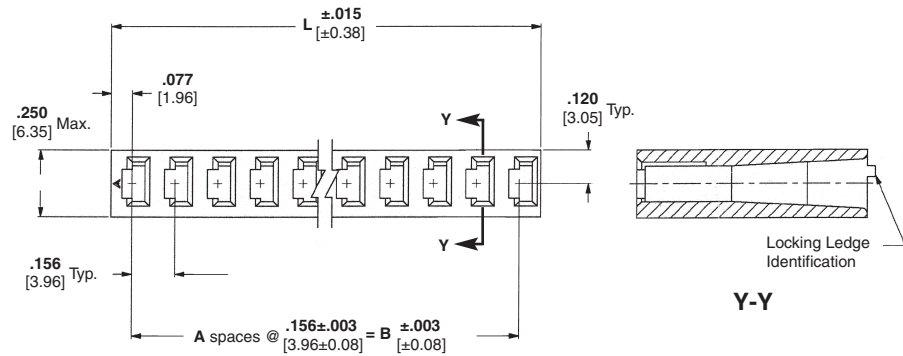

No. of Pos.	Dimensions			Housing Part Nos.	
	A	B	L	Stamped ¹	Unstamped ²
2	1	.156 [3.96]	.312 [7.92]	—	2-87025-5
3	2	.312 [7.92]	.468 [11.89]	—	2-87025-1
4	3	.468 [11.89]	.624 [15.85]	—	1-87025-3
5	4	.624 [15.85]	.780 [19.81]	—	2-87025-3
6	5	.780 [19.81]	.936 [23.77]	87025-1	87025-2
7	6	.936 [23.77]	1.092 [27.74]	—	3-87025-4
8	7	1.092 [27.74]	1.248 [31.70]	—	1-87025-6
9	8	1.248 [31.70]	1.404 [35.66]	87025-9	1-87025-0
10	9	1.404 [35.66]	1.560 [39.62]	1-87025-7	1-87025-8
11	10	1.560 [39.62]	1.716 [43.59]	—	3-87025-6
12	11	1.716 [43.59]	1.872 [47.55]	1-87025-1	1-87025-2
13	12	1.872 [47.55]	2.028 [51.51]	—	3-87025-0
14	13	2.028 [51.51]	2.184 [55.47]	—	3-87025-8
15	14	2.184 [55.47]	2.340 [59.44]	—	3-87025-2
16	15	2.340 [59.44]	2.496 [63.40]	—	2-87025-0
17	16	2.496 [63.40]	2.652 [67.36]	—	4-87025-0
18	17	2.652 [67.36]	2.808 [71.32]	—	87025-4
19	18	2.808 [71.32]	2.964 [75.29]	—	87025-6
20	19	2.964 [75.29]	3.120 [79.25]	—	87025-8
25	24	3.744 [95.10]	3.900 [99.06]	—	5-87025-0

Notes: ¹Markings on housing.
²No markings on housing.

Note: All part numbers are RoHS compliant.

**Mod I Receptacle Housings, Standard Profile, Unkeyed,
.031 x .062 [0.79 x 1.57] Centerline** (Continued)

**Single Row, .156 [3.96]
Centers, With Strain Relief**

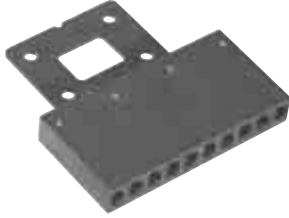

Material

Black thermoplastic, flame retardant,
94V-0 rated

Related Product Data

Contacts used with — page 290

Mate with —

Machine Applied Posts — page 294

Headers — pages 295-297

Performance Specifications —
page 305

Technical Documents —
page 305

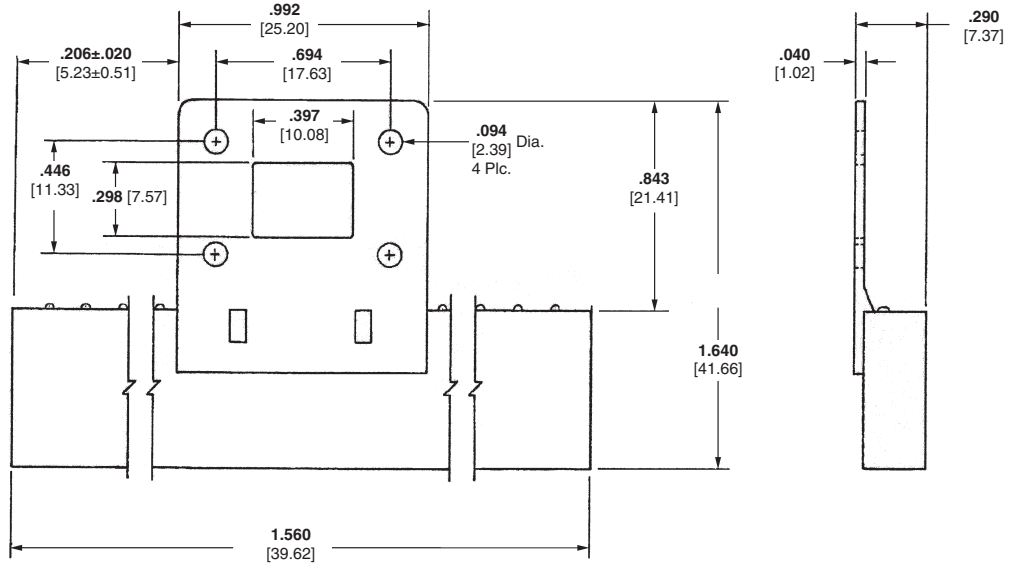

10 Position Receptacle Housing, Part No. 1-102090-0

Note: All part numbers are RoHS compliant.

Mod I Receptacle Housings, Low Profile, Keyed, .031 x .062 [0.79 x 1.57] Centerline

Single Row, .156 [3.96] Centers

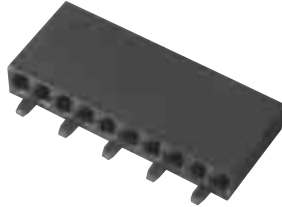

Material

Black thermoplastic, flame retardant, 94V-0 rated

Related Product Data

Contacts used with — page 290

Mate with —

Headers — pages 295-297

Performance Specifications — page 305

Technical Documents

— page 305

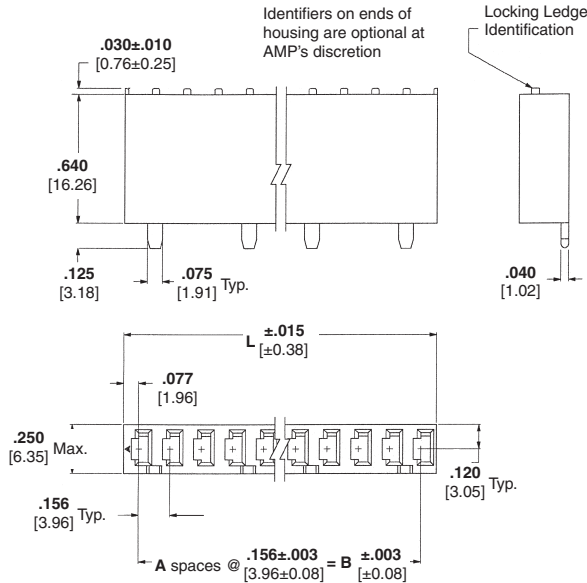

No. of Pos.	Dimensions			No. of Keys	Housing Part Nos. (Unstamped) ¹	Key Locations
	A	B	L			
2	1	.156 [3.96]	.312 [7.92]	1	87159-3	A
3	2	.312 [7.92]	.468 [11.89]	1	87159-4	A
4	3	.468 [11.89]	.624 [15.85]	2	87159-5	A,C
5	4	.624 [15.85]	.780 [19.81]	2	87159-1	A,D
6	5	.780 [19.81]	.936 [23.77]	3	87159-6	A,C,E
7	6	.936 [23.77]	1.092 [27.74]	3	87159-7	A,C,E
8	7	1.092 [27.74]	1.248 [31.70]	4	87159-8	A,C,E,G
9	8	1.248 [31.70]	1.404 [35.66]	3	87159-9	A,D,G
10	9	1.404 [35.66]	1.560 [39.62]	5	1-87159-0	A,C,E,G,J
11	10	1.560 [39.62]	1.716 [43.59]	4	1-87159-1	A,D,G,K
12	11	1.716 [43.59]	1.872 [47.55]	6	1-87159-2	A,C,E,G,J,L
13	12	1.872 [47.55]	2.028 [51.51]	4	87159-2	A,D,J,M
14	13	2.028 [51.51]	2.184 [55.47]	7	1-87159-3	A,C,E,G,J,L,N
15	14	2.184 [55.47]	2.340 [59.44]	5	1-87159-4	A,D,G,K,N
16	15	2.340 [59.44]	2.496 [63.40]	8	1-87159-5	A,C,E,G,J,L,N,Q
17	16	2.496 [63.40]	2.652 [67.36]	6	1-87159-6	A,D,G,K,N,R
18	17	2.652 [67.36]	2.808 [71.32]	6	1-87159-7	A,D,F,J,P,S
19	18	2.808 [71.32]	2.964 [75.29]	8	1-87159-8	B,D,F,J,L,N,Q,S
20	19	2.964 [75.29]	3.120 [79.25]	10	1-87159-9	A,C,E,G,J,L,N,Q,S,U
25	24	3.744 [95.10]	3.900 [99.06]	11	2-87159-4	A,C,E,H,K,M,Q,S,U,W,Y

¹No marking on housing.

Keying Plug

Material — Natural Color Nylon

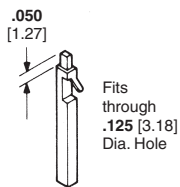

Part No. 87116-2

Keying Plug References

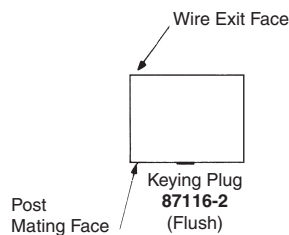

For Standard Housings

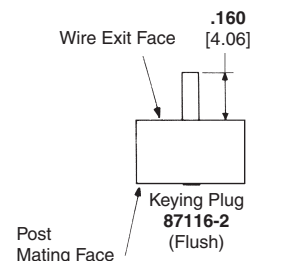

For Low Profile Housings

Note: All part numbers are RoHS compliant.

Mod I Posts, Machine Applied, .031 x .062 [0.79 x 1.57] Centerline

Straight Posts

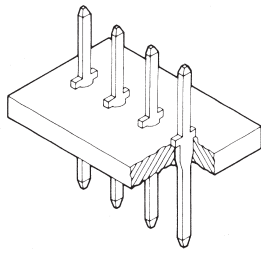

Typical Assembly

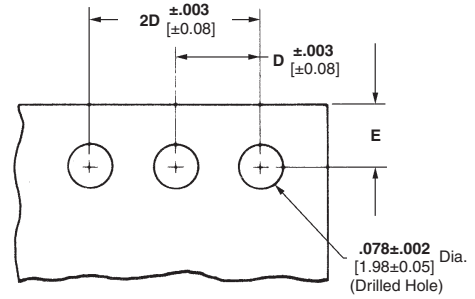
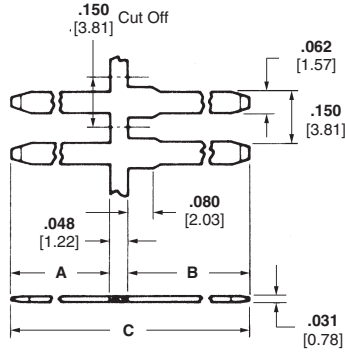

Recommended Mounting Holes

Material and Finish

Brass, plated .000030 [0.00076] gold over .000050 [0.00127] nickel on entire post

Related Product Data

Mate with —

Board Mount Receptacles — pages 285, 286

Board Mount Receptacle Assemblies — pages 287-289

Crimp Snap-In Receptacles and Housings — pages 290-292

Locking Clip Contacts & Housings — pages 298, 299 (see page 298 for recommended post length).

Application Tooling — pages 300-304

Performance Specifications — page 305

Technical Documents — page 305

D—Post centers may vary depending on requirements. Minimum nominal centerline spacing between adjacent contacts is .125 [3.18]; .003 [0.08] tolerances not to accumulate over length of board.
E—Post center location from edge of board may vary to satisfy application.

A	Dimensions		Finish	Part Nos.	
	B	C		Strip Form ¹	Loose Piece ²
.360 [9.14]	.187 [4.75]	.595 [15.11]	Plating A	86147-7	86182-7
			Plating B	5086147-2	5086182-2
.380 [9.65]	.320 [8.13]	.748 [19.00]	Plating A	1-86147-5	1-86182-5
			Plating B	5086147-9	5086182-9
.400 [10.16]	.125 [3.18]	.573 [14.55]	Plating A	4-86147-2	2-86182-9
			Plating B	3-5086147-7	2-5086182-5
.480 [12.19]	.187 [4.75]	.715 [18.16]	Plating A	1-86147-8	1-86182-8
			Plating B	2-5086147-2	2-5086182-2
.565 [14.35]	.187 [4.75]	.800 [20.32]	Plating A	86147-8	86182-8
			Plating B	5086147-1	5086182-1
.800 [20.32]	.150 [3.81]	.998 [25.35]	Plating A	1-86147-2	1-86182-2
			Plating B	1-5086147-0	1-5086182-0

¹ Packaging quantity of 20,000 per reel.

² Packaging quantity of 1,000 per bag.

Note: Strip form posts applied with Insertion Machine No. 3-457382-1, includes power unit and applicator.

Note: All part numbers are RoHS compliant.

Mod I Headers, Straight Post, Keyed, .031 x .062 [0.79 x 1.57] Centerline

Single Row, .156 [3.96] Centers

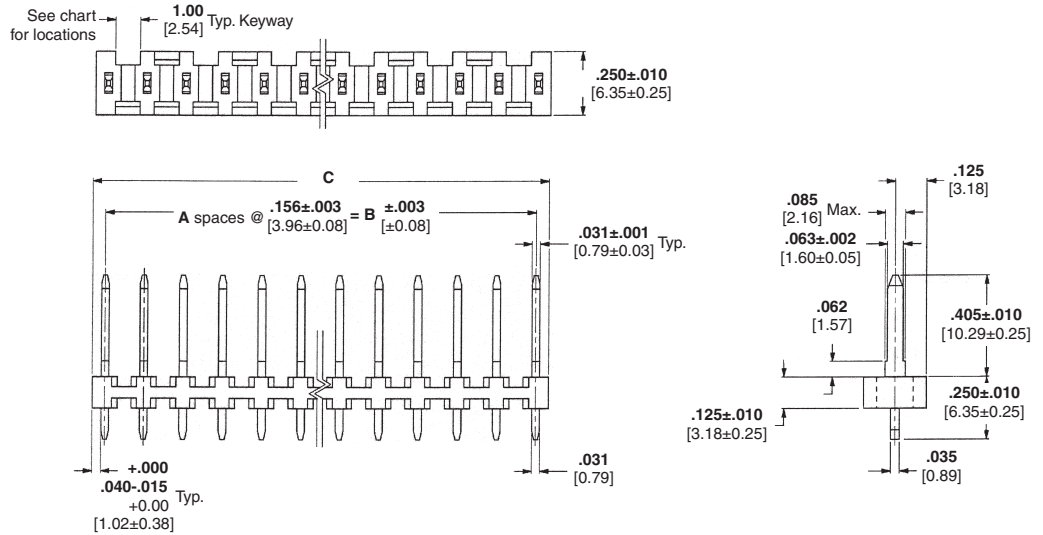
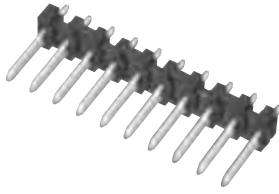

Material and Finish
Housing — Black thermoplastic, 94V-0 rated
Posts — Brass, plated as follows:
Plating A — Selectively plated .000030 [0.00076] gold on contact area, with gold flash over .000050 [0.00127] min. nickel on entire post
Plating B — .000100-.000200 [0.00254-0.00508] tin over .000030 [0.000762] nickel on entire post

Related Product Data

- Mate with** —
- Board Mount Receptacles** — pages 285, 286
- Board Mount Receptacle Assemblies** — pages 287-289
- Crimp Snap-In Receptacles and Housings** — pages 290-292
- Locking Clip Contacts & Housings** — pages 298 & 299 (see page 298 for recommended post length).
- Performance Specifications** — page 305

Technical Documents — page 305

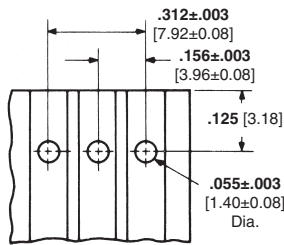

Recommended Board Layout



Keyway Locations (Ref only)

No. of Pos.	A	Dimensions		C	No. of Keying Slots	Post Height D=.405 [10.29]		Post Height D=.587 [14.91]		Keyway Locations
		B				Plating A	Plating B	Plating A	Plating B	
2	1	.156 [3.96]		.267 [6.78]	1	85829-2	5-87160-4	87247-2	5-87262-2	A
3	2	.312 [7.92]		.423 [10.74]	1	85829-3	5-87160-5	87247-3	5-87262-3	A
4	3	.468 [11.89]		.579 [14.71]	2	85829-4	5-87160-6	87247-4	5-87262-4	A,C
5	4	.624 [15.85]		.735 [18.67]	2	85829-5	5-87160-1	87247-5	5-87262-5	A,D
6	5	.780 [19.81]		.891 [22.63]	3	85829-6	5-87160-7	87247-6	5-87262-6	A,C,E
7	6	.936 [23.77]		1.047 [26.59]	3	85829-7	5-87160-8	87247-7	5-87262-7	A,C,E
8	7	1.092 [27.74]		1.203 [30.56]	4	85829-8	5-87160-9	87247-8	5-87262-8	A,C,E,G
9	8	1.248 [31.70]		1.359 [34.52]	3	85829-9	6-87160-0	87247-9	5-87262-9	A,D,G
10	9	1.404 [35.66]		1.515 [38.48]	5	1-85829-0	6-87160-1	1-87247-0	6-87262-0	A,C,E,G,J
11	10	1.560 [39.62]		1.671 [42.44]	4	1-85829-1	6-87160-2	1-87247-1	6-87262-1	A,D,G,K
12	11	1.716 [43.59]		1.827 [46.41]	6	1-85829-2	6-87160-3	1-87247-2	6-87262-2	A,C,E,G,J,L
13	12	1.872 [47.55]		1.983 [50.37]	4	1-85829-3	5-87160-2	1-87247-3	6-87262-3	A,D,J,M
14	13	2.028 [51.51]		2.139 [54.33]	7	1-85829-4	6-87160-4	1-87247-4	6-87262-4	A,C,E,G,J,L,N
15	14	2.184 [55.47]		2.295 [58.29]	5	1-85829-5	6-87160-5	1-87247-5	6-87262-5	A,D,G,K,N
16	15	2.340 [59.44]		2.451 [62.26]	8	1-85829-6	6-87160-6	1-87247-6	6-87262-6	A,C,E,G,J,L,N,Q
17	16	2.496 [63.40]		2.607 [66.22]	6	1-85829-7	6-87160-7	1-87247-7	6-87262-7	A,D,G,K,N,R
18	17	2.652 [67.36]		2.763 [70.18]	7	1-85829-8	6-87160-8	1-87247-8	6-87262-8	A,D,F,J,M,PS
19	18	2.808 [71.32]		2.919 [74.14]	8	1-85829-9	6-87160-9	1-87247-9	6-87262-9	B,D,F,J,L,N,Q,S
20	19	2.964 [75.29]		3.075 [78.11]	10	2-85829-0	7-87160-0	2-87247-0	7-87262-0	A,C,E,G,J,L,N,Q,S,U
21	20	3.120 [79.25]		3.231 [82.07]	7	2-85829-1	7-87160-1	2-87247-1	7-87262-1	A,D,G,K,N,R,U
22	21	3.276 [83.21]		3.387 [86.03]	11	2-85829-2	7-87160-2	2-87247-2	7-87262-2	A,C,E,G,J,L,N,Q,S,U,W
23	22	3.432 [87.17]		3.543 [89.99]	8	2-85829-3	7-87160-3	2-87247-3	7-87262-3	A,D,G,K,N,R,U,X
24	23	3.588 [91.14]		3.699 [93.95]	12	2-85829-4	7-87160-4	2-87247-4	7-87262-4	A,C,E,G,J,L,N,Q,S,U,W,Y
25	24	3.744 [95.10]		3.855 [97.92]	11	2-85829-5	7-87160-5	2-87247-5	7-87262-5	A,C,E,H,K,M,Q,S,U,W,Y

Note: All part numbers are RoHS compliant.

Mod I Headers, Straight Post, Keyed, .031 x .062 [0.79 x 1.57] Centerline (Continued)

No. of Pos.	Dimensions			No. of Keying Slots	Post Height D=.750 [19.05]		Post Height D=1.187 [30.15]		Post Height D=1.310 [33.27]		Keyway Locations
	A	B	C		Plating A	Plating B	Plating A	Plating B	Plating A	Plating B	
	2	1	.156 [3.96]		.267 [6.78]	1	85923-2	5-85875-7	87283-2	—	
3	2	.312 [7.92]	.423 [10.74]	1	85923-3	5-85875-8	87283-3	5-86207-2	85839-3	5-85840-3	A
4	3	.468 [11.89]	.579 [14.71]	2	85923-4	5-85875-1	87283-4	5-86207-9	85839-4	5-85840-4	A,C
5	4	.624 [15.85]	.735 [18.67]	2	85923-5	5-85875-2	87283-5	5-86207-3	85839-5	5-85840-5	A,D
6	5	.780 [19.81]	.891 [22.63]	3	85923-6	5-85875-9	87283-6	—	85839-6	5-85840-6	A,C,E
7	6	.936 [23.77]	1.047 [26.59]	3	85923-7	6-85875-0	87283-7	—	85839-7	5-85840-7	A,C,E
8	7	1.092 [27.74]	1.203 [30.56]	4	85923-8	6-85875-1	87283-8	—	85839-8	5-85840-8	A,C,E,G
9	8	1.248 [31.70]	1.359 [34.52]	3	85923-9	5-85875-3	87283-9	—	85839-9	5-85840-9	A,D,G
10	9	1.404 [35.66]	1.515 [38.48]	5	1-85923-0	6-85875-2	1-87283-0	—	1-85839-0	6-85840-0	A,C,E,G,J
11	10	1.560 [39.62]	1.671 [42.44]	4	1-85923-1	6-85875-3	1-87283-1	—	1-85839-1	6-85840-1	A,D,G,K
12	11	1.716 [43.59]	1.827 [46.41]	6	1-85923-2	5-85875-4	1-87283-2	—	1-85839-2	6-85840-2	A,C,E,G,J,L
13	12	1.872 [47.55]	1.983 [50.37]	4	1-85923-3	6-85875-4	1-87283-3	—	1-85839-3	6-85840-3	A,D,J,M
14	13	2.028 [51.51]	2.139 [54.33]	7	1-85923-4	6-85875-5	1-87283-4	—	1-85839-4	6-85840-4	A,C,E,G,J,L,N
15	14	2.184 [55.47]	2.295 [58.29]	5	1-85923-5	6-85875-6	1-87283-5	—	1-85839-5	6-85840-5	A,D,G,K,N
16	15	2.340 [59.44]	2.451 [62.26]	8	1-85923-6	6-85875-7	1-87283-6	—	1-85839-6	6-85840-6	A,C,E,G,J,L,N,Q
17	16	2.496 [63.40]	2.607 [66.22]	6	1-85923-7	6-85875-8	1-87283-7	—	1-85839-7	6-85840-7	A,D,G,K,N,R
18	17	2.652 [67.36]	2.763 [70.18]	7	1-85923-8	6-85875-9	1-87283-8	—	1-85839-8	6-85840-8	A,D,F,J,M,P,S
19	18	2.808 [71.32]	2.919 [74.14]	8	1-85923-9	7-85875-0	1-87283-9	—	1-85839-9	6-85840-9	B,D,F,J,L,N,Q,S
20	19	2.964 [75.29]	3.075 [78.11]	10	2-85923-0	7-85875-1	2-87283-0	—	2-85839-0	7-85840-0	A,C,E,G,J,L,N,Q,S,U
21	20	3.120 [79.25]	3.231 [82.07]	7	2-85923-1	7-85875-2	2-87283-1	—	2-85839-1	7-85840-1	A,D,G,K,N,R,U
22	21	3.276 [83.21]	3.387 [86.03]	11	2-85923-2	7-85875-3	2-87283-2	—	2-85839-2	7-85840-2	A,C,E,G,J,L,N,Q,S,U,W
23	22	3.432 [87.17]	3.543 [89.99]	8	2-85923-3	5-85875-5	2-87283-3	—	2-85839-3	7-85840-3	A,D,G,K,N,R,U,X
24	23	3.588 [91.14]	3.699 [93.95]	12	2-85923-4	7-85875-4	2-87283-4	—	2-85839-4	7-85840-4	A,C,E,G,J,L,N,Q,S,U,W,Y
25	24	3.744 [95.10]	3.855 [97.92]	11	2-85923-5	7-85875-5	2-87283-5	—	2-85839-5	7-85840-5	A,C,E,H,K,M,Q,S,U,W,Y

Note: All part numbers are RoHS compliant.

Mod I Headers, Right-Angle Post, Keyed, .031 x .062 [0.79 x 1.57] Centerline

Single Row, .156 [3.96] Centers

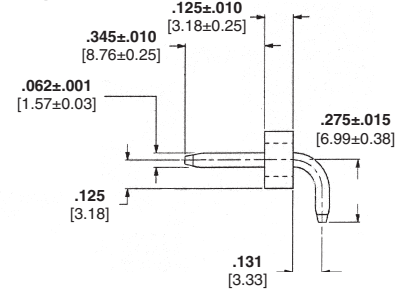
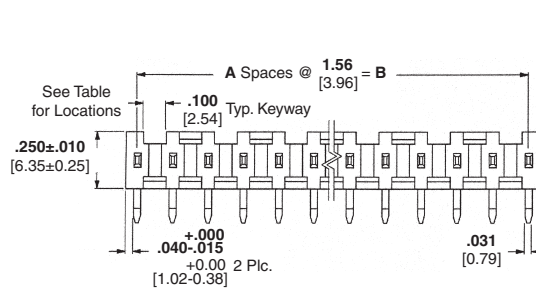
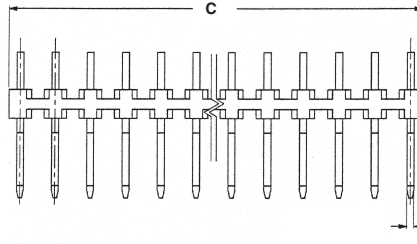
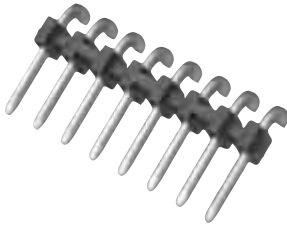

Keyway Locations (Ref Only)

Material and Finish

Housing — Black thermoplastic, 94V-0 rated

Posts — Brass, plated as follows:

Plating A — Selectively plated .000030 [0.00076] gold on contact area, with gold flash over .000050 [0.00127] nickel on entire post

Plating B — .000015 [0.00038] gold over .000050 [0.00127] nickel on entire post

Plating C — .00100-.00200 [0.00254-0.00508] tin over .000050 [0.00127] nickel on entire post

Related Product Data

Mate with — Board Mount Receptacles — pages 285, 286

Board Mount Receptacle Assemblies — pages 287-289

Crimp Snap-In Receptacles and Housings — pages 290-292

Locking Clip Contacts and Housings — pages 298 & 299 (see page 298 for recommended post length).

Performance Specifications — page 305

Technical Documents — page 305

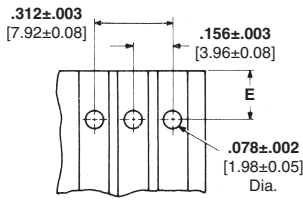

Recommended Board Layout

E Dimension

.345 [8.76] Post Height — .250 [6.35] for mounting header flush with board edge; .595 [15.11] for supporting mating connector on board.

.500 [12.70] Post Height — .250 [6.35] for mounting header flush with board edge; .750 [19.05] for supporting mating connector on board.

No. of Pos.		Dimensions			No. of Keying Slots	Post Height D=.345 [8.76]		Post Height D=.500 [12.70]		Keyway Locations
		A	B	C		Plating A	Plating C	Plating B	Plating C	
2	1	.156 [3.96]	.267 [6.78]	1	87654-2	5-87655-2	87258-2	5-87194-1	A	
3	2	.312 [7.92]	.423 [10.74]	1	87654-3	5-87655-3	87258-3	5-87194-2	A	
4	3	.468 [11.89]	.579 [14.71]	2	87654-4	5-87655-4	87258-4	5-87194-3	A,C	
5	4	.624 [15.85]	.735 [18.67]	2	87654-5	5-87655-5	87258-5	5-87194-4	A,D	
6	5	.780 [19.81]	.891 [22.63]	3	87654-6	5-87655-6	87258-6	5-87194-5	A,C,E	
7	6	.936 [23.77]	1.047 [26.59]	3	87654-7	5-87655-7	87258-7	5-87194-6	A,C,E	
8	7	1.092 [27.74]	1.203 [30.56]	4	87654-8	5-87655-8	87258-8	5-87194-7	A,C,E,G	
9	8	1.248 [31.70]	1.359 [34.52]	3	87654-9	5-87655-9	87258-9	5-87194-8	A,D,G	
10	9	1.404 [35.66]	1.515 [38.48]	5	1-87654-0	6-87655-0	1-87258-0	5-87194-9	A,C,E,G,J	
11	10	1.560 [39.62]	1.671 [42.44]	4	1-87654-1	6-87655-1	1-87258-1	6-87194-0	A,D,G,K	
12	11	1.716 [43.59]	1.827 [46.41]	6	1-87654-2	6-87655-2	1-87258-2	6-87194-1	A,C,E,G,J,L	
13	12	1.872 [47.55]	1.983 [50.37]	4	1-87654-3	6-87655-3	1-87258-3	6-87194-2	A,D,J,M	
14	13	2.028 [51.51]	2.139 [54.33]	7	1-87654-4	6-87655-4	1-87258-4	6-87194-3	A,C,E,G,J,L,N	
15	14	2.184 [55.47]	2.295 [58.29]	5	1-87654-5	6-87655-5	1-87258-5	6-87194-4	A,D,G,K,N	
16	15	2.340 [59.44]	2.451 [62.26]	8	1-87654-6	6-87655-6	1-87258-6	6-87194-5	A,C,E,G,J,L,N,Q	
17	16	2.496 [63.40]	2.607 [66.22]	6	1-87654-7	6-87655-7	1-87258-7	6-87194-6	A,D,G,K,N,R	
18	17	2.652 [67.36]	2.763 [70.18]	7	1-87654-8	6-87655-8	1-87258-8	6-87194-7	A,D,F,J,M,PS	
19	18	2.808 [71.32]	2.919 [74.14]	8	1-87654-9	6-87655-9	1-87258-9	6-87194-8	B,D,F,J,L,N,Q,S	
20	19	2.964 [75.29]	3.075 [78.11]	10	2-87654-0	7-87655-0	2-87258-0	6-87194-9	A,C,E,G,J,L,N,Q,S,U	
21	20	3.120 [79.25]	3.231 [82.07]	7	2-87654-1	7-87655-1	2-87258-1	7-87194-0	A,D,G,K,N,R,U	
22	21	3.276 [83.21]	3.387 [86.03]	11	2-87654-2	7-87655-2	2-87258-2	7-87194-1	A,C,E,G,J,L,N,Q,S,U,W	
23	22	3.432 [87.17]	3.543 [89.99]	8	2-87654-3	7-87655-3	2-87258-3	7-87194-2	A,D,G,K,N,R,U,X	
24	23	3.588 [91.14]	3.699 [93.95]	12	2-87654-4	7-87655-4	2-87258-4	7-87194-3	A,C,E,G,J,L,N,Q,S,U,W,Y	
25	24	3.744 [95.10]	3.855 [97.92]	11	2-87654-5	7-87655-5	2-87258-5	7-87194-4	A,C,E,H,K,M,Q,S,U,W,Y	

Note: All part numbers are RoHS compliant.

Locking Clip Contacts for .031 x .062 [0.79 x 1.57] Posts, .031 x .062 [0.79 x 1.57] Centerline

Wire Crimp Contacts with Insulation Support

Material and Finish

Contact Body — Phosphor bronze, plated as follows:

Plating A — Selectively plated .000015 [0.00038] gold on contact area, with gold flash over .000050 [0.00127] nickel on entire post

Plating B — .000100 [0.00254] min. tin over .000050 [0.00127] nickel on entire contact

Contact Spring — Stainless steel

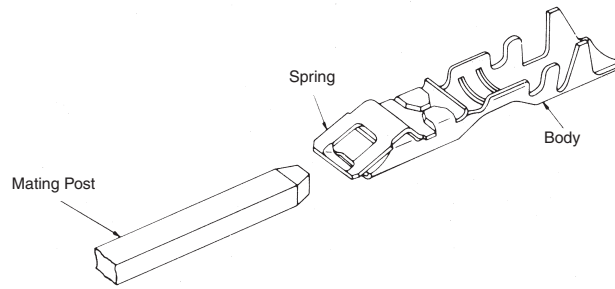

Related Product Data

Mate with —
Machine Applied Posts — page 294
Headers (.500 Post Height Only) — pages 295-297 (see recommended post length below)*

Housings used in — page 299

Application Tooling — pages 300-304

Performance Specification — page 305

Technical Documents — page 305

Wire Size Range AWG [mm ²]	Ins. Dia. Range	Finish	Contact Part Nos.	
			Strip Form	Loose Piece
22-18 [0.3-0.9]	.050-.0100 [1.27-2.54]	Plating A	87269-2	87278-2
		Plating B	5-87269-1	5-87278-1

Wire Size Range AWG [mm ²]	Applicator			Premium CERTI-CRIMP Hand Tool Part Number
	Part Number	Type	Used With Machine	
22-18 [0.3-0.9]	466007-2	HDM	Model "K" (AMP-O-LECTRIC) ¹	90308-1
	466950-2	SCA	Stripper/Crimper (AMP-O-MATIC)	

¹AMP-O-LECTRIC KII Machine. Applicators also available for AMPOMATOR Lead Making Machines. Consult Tyco Electronics.

Note: These contacts must be crimped in accordance with Tyco Electronics Specification No. 114-25008 in order to function properly in a connector housing. Extraction Tool **Part No. 91104-1** is used for removing individual contacts from connector housings and for detaching contacts from mating posts.



Extraction Tool Part No. 91104-1

Instruction Sheet
408-7678

Wire Harnessing

If necessary, wires can be grouped with cable ties and secured to a panel with fixed clamps. However, locking clip contacts must be free to float within the connector housings to allow proper extraction. Therefore, harnessing hardware or the use of multiple terminations per contact must not restrict the free-floating action of contacts in the housing. For more information, request Insulating and Bundling Products Catalog 124132.

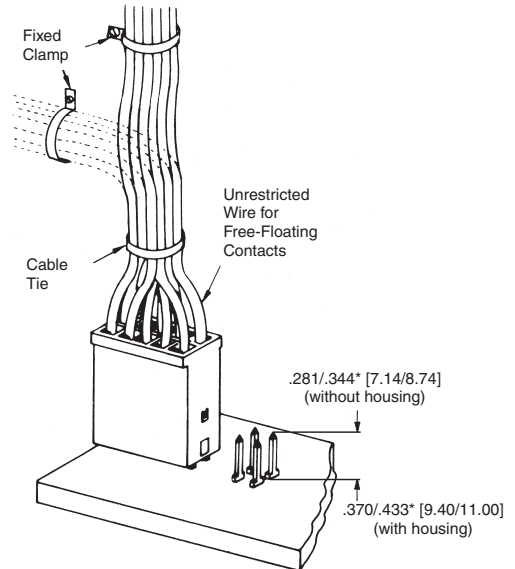

*Dimension defines .031 x .062 [0.79 x 1.57] portion of post. If post is longer than maximum specified, post tip may butt against wire ends.

Note: All part numbers are RoHS compliant.

Locking Clip Connector Housings, .031 x .062 [0.79 x 1.57] Centerline

Single Row, .156 [3.96] Centers

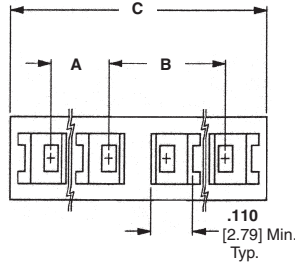
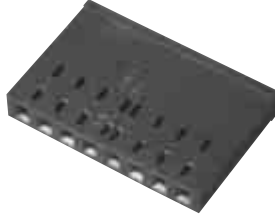

Material and Finish

Black thermoplastic, 94V-0 rated

Related Product Data

Contacts used with — page 298

Mate with —

Machine Applied Posts — page 294

Headers — pages 295-297 (see page 298 for recommended post length)

Performance Specifications — page 305

Technical Documents — page 305

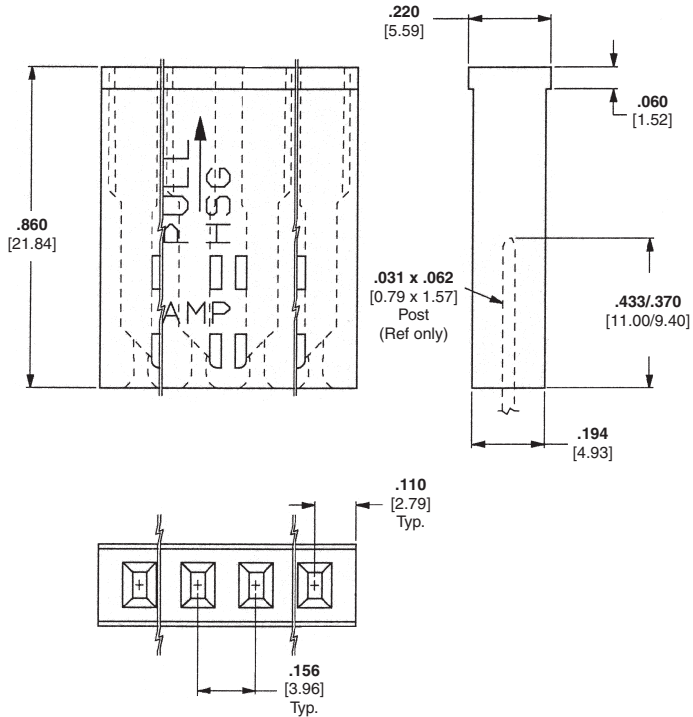

No. of Pos.	Dimensions			Housing Part Nos.		Keyed Positions on Mating Face
	A	B	C	UnKeyed	Keyed	
1	—	—	.200 [5.08]	87270-1	—	—
2	—	—	.376 [9.55]	87270-2	—	—
3	.156 [3.96]	.156 [3.96]	.532 [13.51]	1-87270-3	—	—
3 of 4	.156 [3.96]	.312 [7.92]	.688 [17.48]	—	87270-3	□□■□
4				87270-4	—	—
4 of 5	.312 [7.92]	.312 [7.92]	.844 [21.44]	—	1-87270-0	□□■□
5				1-87270-4	—	—
5 of 6	.312 [7.92]	.468 [11.89]	1.000 [25.40]	—	1-87270-2	□□□■□
6				87270-5	—	—
6 of 7	.468 [11.89]	.468 [11.89]	1.156 [29.36]	—	1-87270-1	□□□■□□
7				1-87270-5	—	—
8	.468 [11.89]	.624 [15.85]	1.312 [33.32]	87270-6	—	—
9	.624 [15.85]	.624 [15.85]	1.468 [37.29]	1-87270-6	—	—
10	.624 [15.85]	.780 [19.81]	1.624 [41.25]	87270-7	—	—
11	.780 [19.81]	.780 [19.81]	1.780 [45.21]	1-87270-7	—	—
12	.780 [19.81]	.936 [23.77]	1.936 [49.17]	87270-8	—	—

■ Indicates "closed cavity". No post entry hole in this position.

Note: All part numbers are RoHS compliant.

Notes: 1. All housings listed above will accept Locking Clip Contacts No. 87269 and 87278, refer to page 298
2. Refer to Tyco Electronics Instruction Sheet 408-7676 for proper contact orientation within the housings.

Application Tooling

For Crimp Snap-In Receptacles and Locking Clip Contacts

Side-Feed Heavy-Duty Miniature Applicators (Coded HDM)



Interchangeable applicators for crimping products reeled side-by-side on single or dual carrier strips (primarily closed-barrel terminals and open-barrel contacts). Similar design as the end-feed version. All side-feed applicators include a wire stop to help correctly position the wire end in the crimping target area.

For more information, request Instruction Sheet **408-8040**.

AMP-O-LECTRIC Model "G" Terminating Machines, 354500-1, -9, -11



Semiautomatic bench machines for crimping reeled terminals and contacts, featuring a quiet and reliable direct motor drive, microprocessor controls for ease of setup and operation, and guarding and lighting designed for operator convenience and safety. All models are equipped with either manual or automatic precision adjustment of crimp height. Machine-mounted sensors are available for crimp quality monitoring using conventional miniature-style applicators.

Specifications

Width — 18.7-25.3 [475-643] depending on applicator type
Depth — 21.5-28.1 [546-713] depending on applicator type
Height — 20 [508]
Weight — 240 lb [110 kg]
Electrical — 120 or 220 VAC, 50 or 60 Hz; 310 VA
Air — 90-110 psi [6.21-7.59 bar], 6 scfm [0.00282 m³/s] when required with air-feed applicators
Wire Range — 26-10 AWG [0.12-6 mm²] solid or stranded, depending on product applied
 For more information, request Catalog **65828**, Video **198116**, Catalog **82275 [Crimp Quality Monitor (CQM)]**, Video **198094**.

AMPOMATOR CLS IV+ Lead-Making Machines, 356500-1, -2, 1213400-1, -2



Fully-automatic machines that measure, cut, strip and terminate single leads. Microprocessor-controlled, and programmed and operated using an easy-to-follow, menu-driven touchscreen. Features include direct-drive terminating units with precision crimp height adjustment, fully programmable setups, wire runout and splice detection, and motorized pre-feed with wire straightener. Crimp quality monitoring is also available.

Specifications

Width — 159 [4 040]
Depth — 68 [1 730]
Height — 86 [2 185] with 24 [610] dia. reel
Weight — 2 000 lb [907 kg]
Electrical — 220 VAC, 50 or 60 Hz, single phase, 25 A, with neutral and ground
Air — 90 psi [6.21 bar], 15 scfm [0.0071 m³/s] sustained
Wire Range — 26-10 AWG [0.12-6 mm²] stranded, 26-16 AWG [0.12-1.4 mm²] solid
Lead Lengths — 3-90 [76.2-2 285], 90-1 000 [2 285-25 400] with long lead conveyors
 For more information, request Catalog **124324**, Video **198142 (NTSC)**, **199609 (PAL)**.

Note: All part numbers are RoHS compliant.

Note: For additional tooling options, contact Tyco Electronics or reference the Tyco Electronics web site.

Application Tooling (Continued)

For Crimp Snap-In Receptacles and Locking Clip Contacts (Continued)

AMP-O-MATIC Stripper-Crimper Machines, 854040-3, -4



Semiautomatic bench crimping machines that also strip the wire, and are therefore used for terminating jacketed cable. Feature manual precision adjustment of crimp height, keyed strip blades for faster, more accurate setups, and an efficient scrap removal system. All adjustments can be made from the front of the machines without special tools. Available with crimp quality monitoring.

Specifications

Width—14 [355]
Depth—18 [457]
Height—33 [838] without reel
Weight—150 lb [68 kg]
Electrical—120 VAC, 50 or 60 Hz, .5 A
Air—80-100 psi [5.52-6.90 bar], 3.5 scfm [0.00165 m³/s]
Wire Range—32-14 AWG [0.03-2 mm²]
 For more information, request Catalog **65004**, Video **198075**, Catalog **82275 [Crimp Quality Monitor (CQM)]**, Video **198094**.

Stripper-Crimper Applicators (coded SCA)



Interchangeable applicators for crimping products in AMP-O-MATIC Stripper-Crimper Machines. Consist of separate ram and lower tooling assemblies. Similar dial-in settings for different wire sizes and insulation diameters as HDM applicators. Available with sensors for use with the Crimp Quality Monitor.

For more information, request Catalog **65004 (AMP-O-MATIC Stripper-Crimper Machines)**, Catalog **82275 [Crimp Quality Monitor (CQM)]**.

Kappa 235, Automatic Cut and Strip, 3-547178-1



The Kappa 235 has the capability of processing wires with a cross section of up to 4 AWG and an outside diameter of 0.59 inch. Options include an inner conductor processing kit for multiconductor cables and a flat ribbon cable kit.

Specifications

Width—25 [630]
Depth—16 [490]
Height—13.4 [370]
Weight—95 lb [44 kg]
Wire Cross-Sections—24-4 AWG [0.22-25 mm²]
Flat Ribbon Cables—width up to 40mm
Length Range—0.04"-328ft [1mm - 99.99m] (+/- 0.2%)
Electrical—110/230 V - 50/60Hz, switches automatically

Cosmic 927R Micro-Cable Stripper



The Cosmic 927R Micro-Cable Stripper was developed to reliably strip various insulation materials and micro-cable. From conductor diameter 36 AWG to 10 AWG, the stripping diameter display can be set to within 0.1mm increments.

Thus optimal stripping quality is guaranteed and damage to the conductor is eliminated.

Note: All part numbers are RoHS compliant.

Note: For additional tooling options, contact Tyco Electronics or reference the Tyco Electronics web site.

Application Tooling (Continued)

For Crimp Snap-In Receptacles and Locking Clip Contacts (Continued)

CERTI-CRIMP Straight Action Hand Tools (SAHT)



Premium grade hand tools. Feature ratchet control to provide complete crimp cycle. Die sets close in a straight line. Include a contact locator and wire stop, plus an insulation crimp adjustment lever, when applicable. Approximate weight 1.3 lb [0.59 kg]

All CERTI-CRIMP head assemblies / dies, have multiple power options available. The accompanying diagram outlines those power options. See catalogs 1654714 (SDE Electric Terminator), 124208 (626 Pneumatic Tool System) and 1773381(Battery-Powered Crimp Tool Kits) for more information.

For more information, request Catalog **65780**.



PRO-CRIMPER III Hand Tool



Commercial grade hand tool for crimping various products. Features ratchet control to provide complete crimp cycle. Accepts both pinned- and shouldered-style die sets. Locators are provided with pinned-style die sets for proper contact and wire positioning, and to help minimize contact rotation and bending during crimping. Approximate weight 1.3 lb [0.60 kg].

All PRO-CRIMPER head assemblies / dies, have multiple power options available. The accompanying diagram outlines those power options. See catalogs 1654714 (SDE Electric Terminator), 124208 (626 Pneumatic Tool System) and 1773381(Battery-Powered Crimp Tool Kits) for more information.

Instruction Sheet
408-9930



Note: For additional tooling options, contact Tyco Electronics or reference the Tyco Electronics web site.

Application Tooling (Continued)

For Board Mount Receptacles and Machine Applied Posts

Modular Insertion System (MIS) Bench Machines, 217600 Series, 662820 Series (shown)



For Board Mount Receptacles

Bench machines for inserting a variety of products into pc boards. Uses the same interchangeable insertion heads as the Comp-U-Sertor II Machines. Series 217600 machines feature a manually-operated X-Y positioning fixture, plus a locator spotlight. The machine cycles when the board hole is placed on the anvil and both triggers on the dual handles attached to the X-Y fixture are depressed. Series 662820 machines, without board fixturing, cycle automatically when the hole is properly located. A stabilizing disk over the anvil helps keep the board level.

This benchtop insertion machine installs contacts into PC boards at rates to 2000 per hour. A spotlight highlights the insertion area, and lower tooling assures precise board location. The machine is activated by a foot pedal.

Specifications

- Width** — 18 [457]
 - Depth** — 24 [610]
 - Height** — 18 [457]
 - Weight** — 250 lb [113 kg]
 - Electrical** — 120 to 220 VAC, 50 or 60 Hz (217600); 120 or 240 VAC, 60 Hz, single phase, 120 VA (662820)
 - Air** — 80 psi [5.52 bar] min., 15 scfm [0.00708 m³/s] min.
 - Insertable Area** — 18 x 22 [457 x 559] max.
- For more information, request Catalog **296059**.

P300 Automatic Insertion Machine



Automatic machine for inserting a variety of contacts into pc boards (PCBs). Equipped with an insertion tool (comprised of a product-specific insertion head, an anvil, and a product feed mechanism). Stepper-motor driven X-Y table positions PCBs under insertion head. Surface Mount Equipment Manufacturers Association (SMEMA) compatible inline PCB Insertion Station for posts, tabs, receptacles or sockets. Stand-alone unit is field upgradeable to Pass Through. Mounts up to four Tyco Electronics pneumatic insertion heads. Modem diagnostics standard, vision system optional. Control panel used to program and monitor entire insertion process.

Specifications

- Width** — 57.5 [1 460]
 - Depth** — 64.5 [1 640]
 - Height** — 60 [1 520]
 - Weight** — Depending on configuration
 - Electrical** — 110 V, 60 Hz
 - Air** — 87 psi [6 bar]
 - Insertable Area** — 24 x 16 [600 x 400]
- For more information, contact Tyco Electronics.

Note: All part numbers are RoHS compliant.

Note: For additional tooling options, contact Tyco Electronics or reference the Tyco Electronics web site.

Application Tooling (Continued)

**For Board Mount
Receptacles and Machine
Applied Posts** (Continued)

P350 Pin Insertion Machine



The P350 is a fully automatic inline pin insertion machine capable of applying reeled pins, tabs, receptacles and similar products into PCBs. With inline operation, an automatic tool changer and insertion rates up to 5 per second, it is focused at fully automatic high speed operation to maximize throughput while minimizing costly scrap.

A servo powered XY table positions the PCB under a central drive station at high speed. The tool changer can hold up to 3 insertion heads each capable of applying a different product. A unique rotary insertion finger allows the application of products at up to 7 different angles without rotating the PCB. This allows the P350 to apply product at different angles without a reduction in insertion rate or the potential positioning error associated with PCB rotation. Icon driven software with touch screen provides a simple to use, intuitive operator interface. The P350 provides a wide range of solutions for pin insertion applications. Quick change tooling packs, and a wide range of options make it a flexible high speed platform.

Specifications

- Width** — 102 [2600]
- Depth** — 118 [3000]
- Height** — 87 [2200]
- Weight** — approx 3500 lb [1600 kg]
- Electrical** — 230 V, 50-60 Hz, 10 A
- Air** — 600 kPa dried air
- Max. Board Size** — 17.5 x 17.5 [450 x 450]

Performance Specifications

The electrical, mechanical and environmental characteristics of the AMPMODU .031 x .062 [0.79 x 1.57] Interconnection System are listed below:

Mechanical Characteristics

Contact Durability

Plating	Receptacles		Locking Clip Contacts
	Standard Pressure	High Pressure	
.000016 [0.00041] Min. Tin	75 Cycles	25 Cycles	N/A
.000079 [0.00201] Min. Tin	75 Cycles	25 Cycles	N/A
.000100 [0.00254] Min. Tin	N/A	N/A	25 Cycles
.000015 [0.00038] Gold	75 Cycles	50 Cycles	25 Cycles
.000030 [0.00076] Gold	200 Cycles	100 Cycles	N/A

Electrical Characteristics

Contact Current Rating —

5 amperes max. for single contact in free air, could vary due to ambient temperature, wire size and duty cycles.

Contact Resistance —

12 milliohms at 100 ma and 50 mv open circuit.

Dielectric Rating —

At Sea Level – 1200 VAC between contacts on .156 [3.96] centers for 1 minute.

Insulation Resistance — 5 x 10³ megohms (initial)

Connector Durability

Receptacles

Mating – 16 oz. [4.45N] max. per contact after 3 mating cycles (standard pressure)

–30 oz. [8.34N] max. per contact after 3 mating cycles (high pressure, gold)

–60 oz. [16.68N] max. per contact after 3 mating cycles (high pressure, tin)

Unmating – 1 oz. [0.28N] min. per contact after 3 mating cycles (standard pressure)

3 oz. [0.83N] min. per contact after 3 mating cycles (high pressure)

Locking Clip Contacts

Mating – 4 lb. [17.79N] max. per contact after 3 mating cycles

Unmating – 2 lb. [8.90N] min. per contact after 3 mating cycles

Environmental Characteristics

Operating Temperature — -65°C to 105°C [-85°F to 221°F] (Gold Plated)

-65°C to 60°C [-85°F to 140°F] (Tin Plated)

Technical Documents

Various technical documents are available for your use:

Product Specifications

describe technical performance characteristics and verification tests. They are intended for the Design, Component and Quality Engineer.

108-25016 Interconnection System, Standard Pressure

108-25025 Interconnection System, High Pressure, Gold

108-25025-1 Interconnection System, High Pressure, Tin

108-36029 Locking Clip Connectors

Application Specifications

describe requirements for using the product in its intended application and/or crimping information. They are intended for the Packaging and Design Engineer and the Machine Setup Person.

114-25000 Crimp Snap-In Receptacle Contacts

114-25004 Board Mount Receptacle Contacts

114-25008 Locking Clip Contacts

114-25011 Machine Applied Straight Posts

Instruction Sheets

provide instructions for assembling or applying the product. They are intended for the Manufacturing Assembler or Operator.

408-7308 Clinching Procedures for Header Assemblies

408-7411 Suggestions for Wave Soldering AMPMODU Receptacles

408-7594 Tyco Electronics Hand Tool 90274-2 for Crimping Crimp Snap-In 18-22 AWG Contacts

408-7750 Tyco Electronics Hand Tool 90328-1 for Crimping Crimp Snap-In Contacts (22-26 AWG)

408-7676 AMPMODU Locking Clip Connectors and Contacts

408-7671 Tyco Electronics Hand Tool 90308-1 for Crimping Locking Clip Contacts

408-7678 Tyco Electronics Extraction Tool 91104-1 for Locking Clip Contacts

408-7981 Clinching Procedures for Receptacle Assemblies

408-9451 Tyco Electronics Extraction Tool 843473-1 for Crimp Snap-In Receptacles

Note: All part numbers are RoHS compliant.

Shunts

Product Facts

- **7600 Series Programmable Shunts** use conventional .100 x .300 [2.54x7.62] DIP leg spacing
- **Post Shunts** are used to common pairs of .025 [0.64] square posts, .025 [0.64] diameter round posts and .022 x .026 [0.56 x 0.66] formed posts

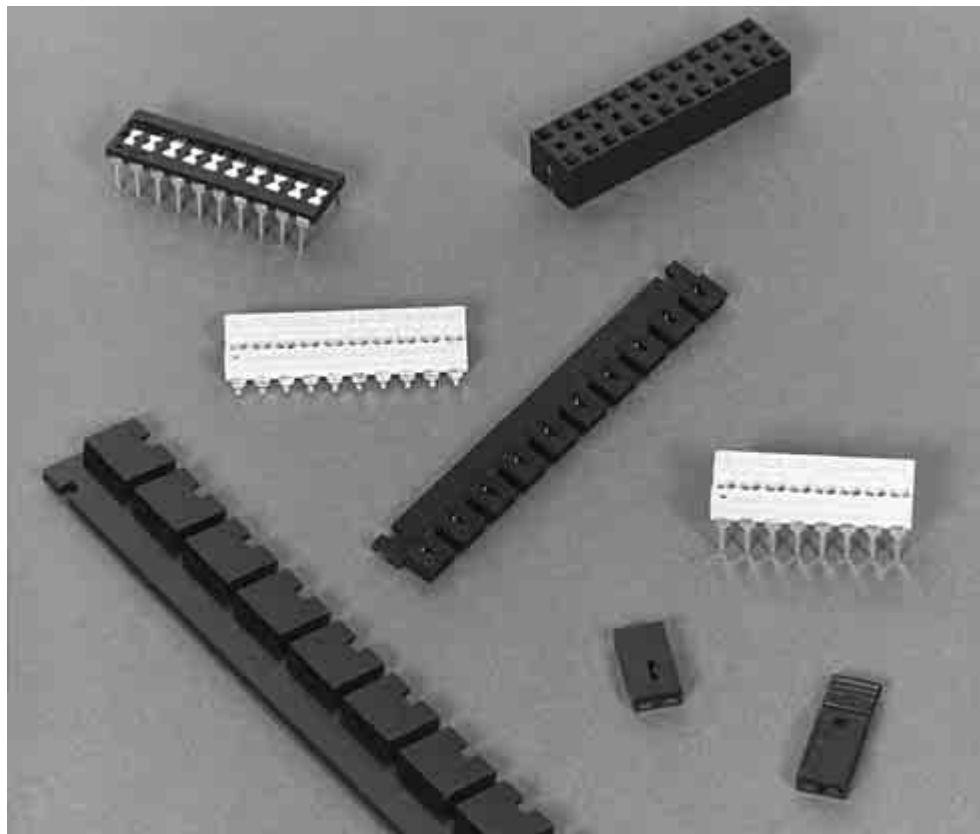

Tyco Electronics offers a variety of high quality shunts for low cost manual programming. Tyco Electronics 7600 Series Programmable Shunts are designed on the standard .100 x .300 [2.54 x 7.62] DIP spacing.

Tyco Electronics DIP Shunts are a highly reliable, low cost means of manually programming various types of electrical/electronic equipment. The shunt consists of a series of conductive straps packaged in a DIP configuration. The straps can be retained intact for a closed circuit or broken with a hand tool to produce an open circuit.

Tyco Electronics Post Shunts mate with any common pairs of square, rectangular and round posts. Post shunts come in two-position low profile, 2 mm miniature, tandem spring, dual beam, and multiposition versions.

Among the options available are choices of gold or tin plating, beryllium copper or phosphor bronze contact material and shunts with 94V-0 rated housing spaces on .079 [2.00], .100 [2.54] and .200 [5.08] centers with the low profile series requiring only .250 [6.35] clearance from the pc board.

All Tyco Electronics shunts feature one-piece construction for high reliability. All have high normal forces for excellent electrical continuity. For added reliability, Tandem Spring and Dual Beam Shunts have two points of contact in each receptacle.

Dual In-Line Package (DIP) Shunts — 7600 Series

**Standard Shunt
Standard Pressure**

Material and Finish

Housing — Glass-filled polyester, UL 94V-0 rated

Contacts — Brass

Finish — Selectively plated .000100 min. tin on solder area over .000050 min. nickel on entire contact

Contact Lead Spacing — .100 x .300 [2.54x7.62]

Lead Length — .140 [3.56] below mounting surface

Housing Color — Black

Programming Tool — See below

Programming Hand Tool

Part No. 435862-1



This tool provides a reliable means of programming DIP shunts. It is rugged, light-weight and dependable. No special skills are required to use this tool.

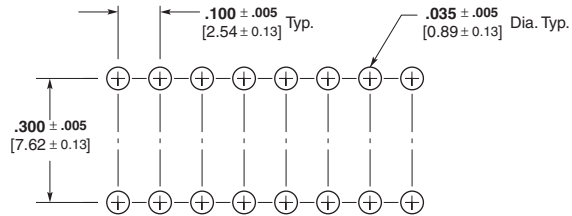
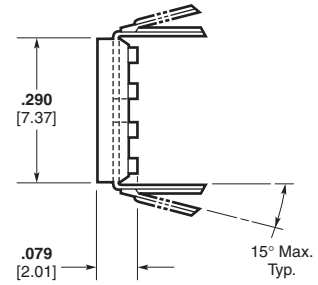
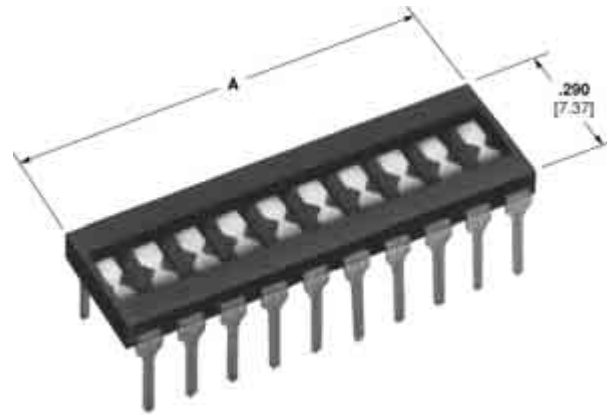

No. of Pos.	Dimension A		Standard Shunt Standard Pressure
	inch	mm	
4	.400	10.16	1825190-4
6	.600	15.24	1825190-6
7	.700	17.78	1825190-7
8	.800	20.32	1825190-8
9	.900	22.86	1825190-9
10	1.000	25.40	1-1825190-0
12	1.200	30.48	1-1825190-2

Note: All part numbers are RoHS compliant.

Post Shunts

Product Facts

- One-piece contact construction
- High normal forces
- 94V-0 rated housings
- Gold inlay, gold plate or tin plate over nickel
- Stackable
- Those post shunts indicated are recognized under the component program of Underwriters Laboratories Inc., File No. E28476 and certified by the Canadian Standards Association File No. LR 7189



2-Position, Low Profile Shunts

Economy Shunt
.100 [2.54] Centerline

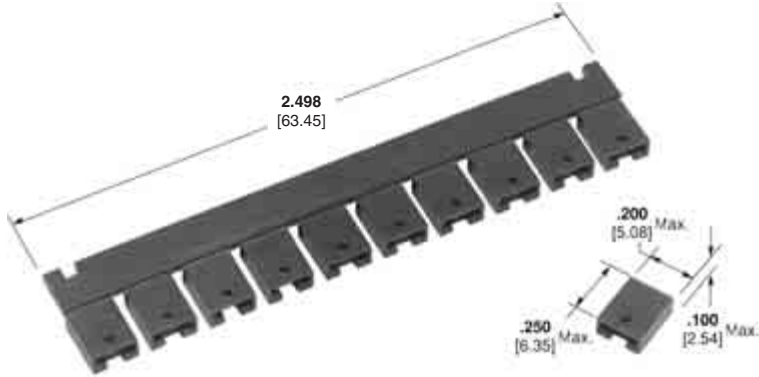

Configuration	Housing Color	Part Numbers			
		Gold Plate ¹ .000015 [0.00038]	Gold Flash ¹ .000005 [0.00013]	Tin Plate .000100 [0.00254]	Gold Plate .000030 [0.00076]
Strip of 10	Blue	382811-2	—	—	—
Strip of 10	Black	382811-6	382811-8	382811-5	2-382811-0
Strip of 10	Red	382811-9	—	—	—
Loose Piece	Black	1-382811-6	1-382811-8	—	—

¹In contact area

Tandem Spring Shunts

- Two points of contact provide extra reliability
- Shunts accept posts as short as .175 [4.45]; posts bottom at .330 [8.38]

2mm Mini Shunts

- Stackable on 2mm contact centerline
- Low profile
- Available in strips of 10

Standard Housing Shunt
.200 [5.08] Centerline

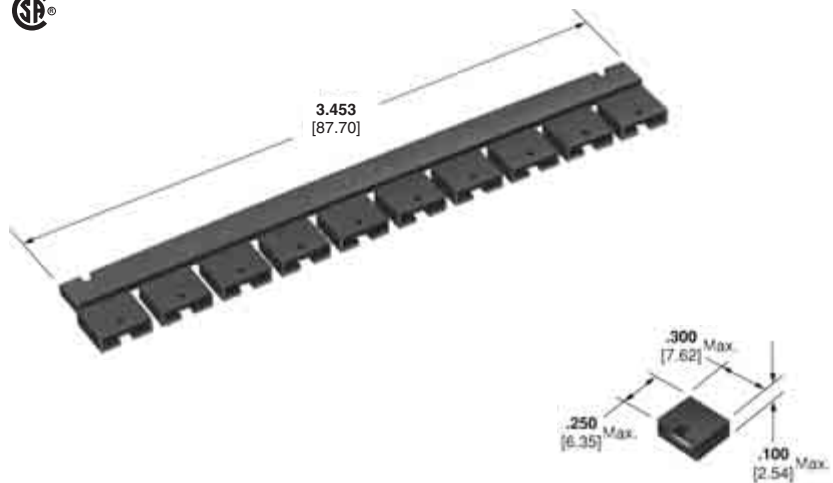

Configuration	Housing Color	Part Numbers		
		Gold Plate ¹ .000015 [0.00038]	Gold Plate ¹ .000030 [0.00076]	Tin Plate .000100 [0.00254]
Strip of 10	Black	531230-2	531230-3	531230-1

¹In contact area

Material and Finish — Low Profile and 2mm Shunts

Housing — Glass-filled thermoplastic, black, UL 94V-0 rated

Contacts — Beryllium copper or phosphor bronze, plated .000050 [0.00127] nickel underplate with gold plate in contact area or tin overall

Material and Finish — Tandem Spring Shunts

Housing — Nylon, UL 94V-0 rated

Contacts — Phosphor Bronze

Finish — .000030 [0.00076] nickel underplate with gold inlay in the contact area or tin overall

Note: All part numbers are RoHS compliant.

Post Shunts (Continued)

2-Position, Low Profile Shunts (Novo)
(Continued)

Handle Shunt
.100 [2.54] Centerline

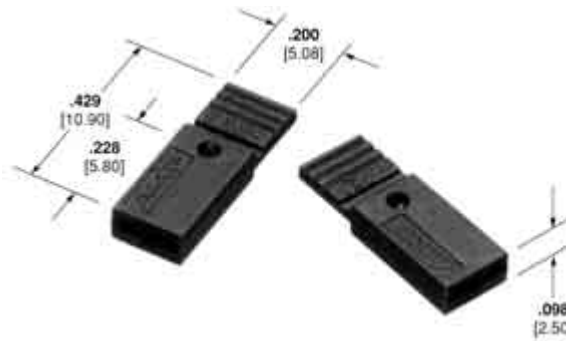

Housing Color	Loose Piece Part Numbers				Type
	Gold Plate ¹ [0.00038]	Gold Plate ¹ [0.00076]	Gold Plate ¹ [0.00127]	Tin Plate [0.00254]	
Black	881545-1	881545-2	881545-3	4-881545-2	Open Top
Black	880584-1	880584-2	880584-3	880584-4	Closed Top

¹In contact area

2 mm Mini-Shunt
.079 [2.00] Centerline

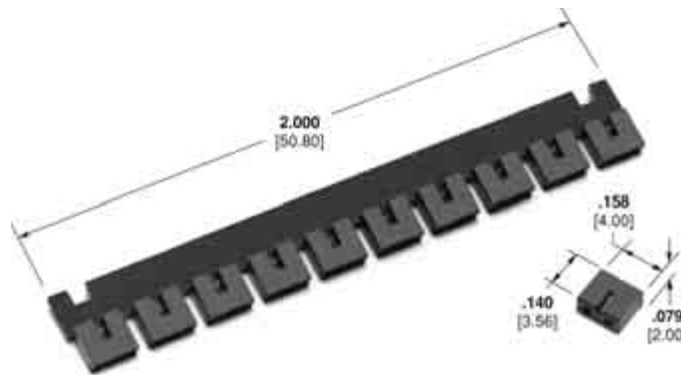

Configuration	Housing Color	Part Numbers	
		Gold Plate ¹ [0.00038]	Gold Plate ¹ [0.00076]
Strip of 10	Black	382575-2	382575-3

¹In contact area

Dual Beam Shunt

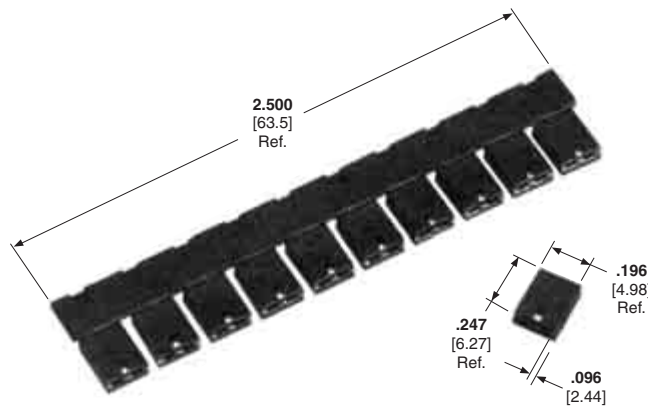

Configuration	Housing Color	Part Numbers		Type
		Gold Plate ¹ [0.00038]	Gold Plate ¹ [0.00076]	
Strip of 10	Black	390088-2	390088-1	Open Top
Strip of 10	Blue	390088-4	390088-3	Open Top
Strip of 10	Yellow	—	390088-5	Open Top

¹In contact area

Note: All part numbers are RoHS compliant.

Post Shunts (Continued)

Tandem Spring Shunt

.100 [2.54] Centerline

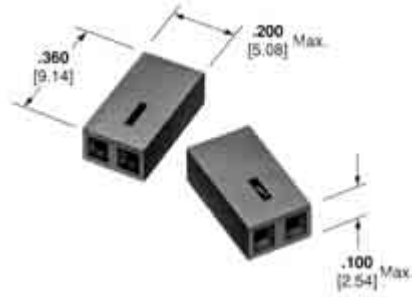

Housing Color	Part Numbers	
	Gold Inlay ¹	TinPlate
	.000030 [0.00076]	.000100 [0.00254]
Black	530153-2	4-530153-1

¹In contact area

Multiposition Shunts for .025 [0.64] Square Posts

.200 [5.08] Centerline



Housing — Glass-filled polyester
Contacts — Beryllium Copper
Finish — .000030 [0.00076] gold in contact area over .000050 [0.00127] nickel on entire contact
Current Rating — 2.5 amps

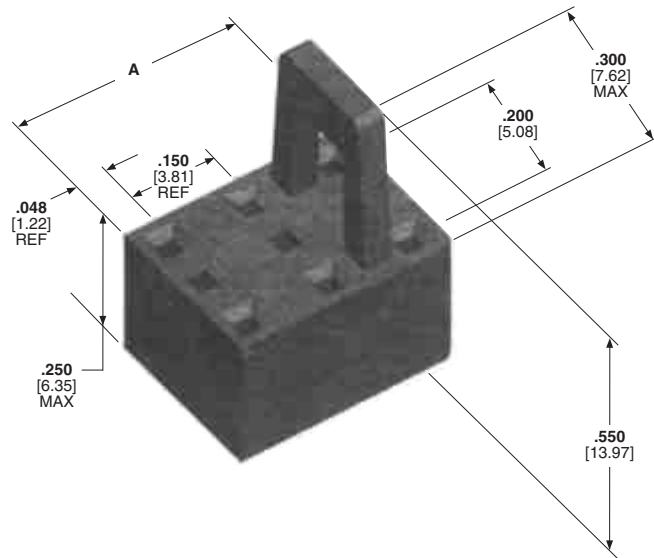

Size	Dimension A		Housing Color	Part Number
	inch	mm		
2x2	.246	6.25	Black	390102-1
2x2	.246	6.25	Red	390102-3
2x3	.396	10.01	Black	390102-2

Shunts

8

Note: All part numbers are RoHS compliant.

Performance Specifications

Dual In-Line Package (DIP) Shunts — 7600 Series

Current Rating —

Standard pressure — 2 amperes for +20°C rise above ambient (one conductor per shunt)
Machine insertable — 1 ampere for +20°C rise above ambient (one conductor per shunt)

Insulation Resistance — 1×10^{10} ohms min. at 100 VDC

Dielectric Withstanding Voltage — 500 VDC min.

Capacitance — 2 picofarads max. between adjacent straps

Temperature Rating — -55°C to +105°C

Terminal Strength (Bend Test) — Two 45° bend cycles per MIL-STD-202, Method 211, Condition B

Solder Bridging —

Cut straps can be reconnected by solder bridging. Solder bridging recommendations are:

- Use low temperature solder (60/40 tin/lead)
- Use solder tip approximately 1/32 [0.79] in diameter
- Do not let solder tip come in contact with plastic material

Post Shunts

Current Rating —

3 amperes max. unless otherwise noted

Temperature Rating — -65°C to +105°C (gold) -40°C to +85°C (tin)

Technical Documents

Various technical documents are available for your use:

Product Specifications describe technical performance characteristics and verification tests. They are intended for the Design, Component and Quality Engineer.

108-7533	Dual In-Line Package (DIP) Shunts
108-1445	2mm Mini Shunt
108-1476	Economy Shunt, Multiposition Shunt
108-1674	Dual Beam Shunt
108-9057	Low Profile Shunt
108-9062	Tandem Spring Shunt
108-37006	Novo Shunt with Handle

Application Specifications describe requirements for using the product in its intended application and/or crimping information. They are intended for the Packaging and Design Engineer and the Machine Setup Person.

114-1045	Tandem Spring Shunt
114-1054	Dual In-Line Package (DIP) Shunts
114-1059	Economy Shunt, Dual Beam Shunt, Low Profile Shunt, Multiposition Shunt
114-1074	2mm Mini Shunt

Instruction Sheets provide instructions for assembling or applying the product. They are intended for the Manufacturing Assembler or Operator.

408-7768	Dual In-Line Package (DIP) Shunts
408-3208	Tandem Spring Shunt
408-3230	Economy Shunt, Dual Beam Shunt, Low Profile Shunt
408-3251	Multiposition Shunt
408-3276	2mm Mini Shunt

Engineering Notes



Part Number Index

Note: This index lists all cataloged parts by base no. only. Complete part nos. (with prefixes and/or suffixes) are shown on the page(s) indicated.

Part No.	Page	Part No.	Page	Part No.	Page
19156	139, 140	87227	85, 96, 97	102104	290
57013	58	87230	85, 98, 99	102106	290
57038	58	87232	85, 94, 95, 210, 221	102107	211
57118	58	87233	94, 95	102114	203
57119	58	87247	295	102128	210, 213
57131	58, 59	87258	297	102185	255, 258, 259
57138	58	87262	295	102198	139, 140
57139	58	87269	298	102202	115, 210
57144	58	87270	299	102203	85, 116
57145	58	87278	298	102241	210, 215
57288	58	87283	296	102312	258, 259
57289	58	87309	213	102316	213
57290	58	87316	286	102338	203
85487	286	87456	210, 216	102348	211
85493	286	87474	129	102387	210, 220
85829	295	87483	210	102393	256
85839	296	87496	133	102394	256
85840	296	87499	210, 214	102395	265
85875	296	87523	213	102396	255, 259
85923	296	87568	127	102398	255, 256
85969	213	87572	126	102399	265
86016	213	87577	124, 125	102448	256
86147	294	87579	122, 123	102449	265
86177	216	87587	119, 120	102523	116
86181	285, 287, 288	87589	117, 118	102536	255, 259
86182	294	87605	85, 131	102537	255, 259
86207	296	87608	130	102540	255, 259
86286	169, 172, 175-177, 180, 182, 189, 191, 195-197, 214-218, 220, 256, 257	87623	163	102541	255, 259
86432	286	87631	210, 218, 219	102548	213
86434	286	87654	297	102557	149
86477	286	87655	297	102567	198
86479	98, 99	87666	213	102570	124, 125
86480	286	87667	213	102589	193, 200
86492	213	87710	218	102617	122, 123
87003	286	87733	219	102618	117, 118
87022	163	87743	204	102619	119, 120
87025	291	87756	210, 213	102620	127
87046	213	87772	286	102641	265
87077	214-218, 220, 256, 257	87774	286	102642	265
87105	286	87809	213	102666	199
87107	211	87878	163	102681	255, 259
87116	293	87879	85, 177	102690	193, 199
87124	207	87921	218	102691	199
87131	209	87922	218, 219	102692	198
87132	209	87977	210, 217	102693	257
87133	209	87983	287	102694	257
87159	293	87984	287	102695	257
87160	295	87985	287	102699	85, 148
87165	207	87986	287	102742	177
87175	208	87987	289	102766	142
87176	209	87988	289	102777	199
87179	208, 209	87989	287	102783	262, 263
87190	207	87990	287	102784	262, 263
87191	207	87993	287	102785	262, 263
87194	297	87995	289	102786	262, 263
87195	213	102055	126	102787	262, 263
87215	96, 97	102090	292	102788	262, 263
87220	85, 93	102095	211	102789	263
87224	93	102099	290	102791	264
		102100	290	102792	264
		102102	290	102802	200
		102103	290	102823	259

Part Number Index (Continued)

Part No.	Page	Part No.	Page	Part No.	Page	Part No.	Page
102826	144	103639	245	103960	231	104895	19
102871	143	103640	231	103961	231	104905	208
102898	146	103641	231	103968	233	104909	245
102903	263	103644	231	103969	233	104910	245
102917	213	103645	231	103970	233	104935	247
102918	213	103648	233	103971	233	111196	56
102920	213	103649	233	103972	233	146079	163
102935	280	103650	233	103973	233	146128	109
102972	107	103651	233	103974	229	146129	109
102973	107	103652	233	103975	229	146130	110
102976	107	103653	237	103976	229	146131	110
102977	107	103654	239	103977	229	146132	86, 109
102985	263	103655	239	103978	229	146133	109
102987	261, 263	103656	239	103979	229	146134	86, 110
102988	261, 263	103657	239	104068	30	146135	110
102991	264	103658	237	104069	29	146138	178
103056	281	103659	237	104071	28	146205	202
103058	281	103660	237	104074	27	146250	104, 107
103080	115	103661	237	104076	31	146252	104, 107
103136	261, 263	103669	245	104078	40	146253	104, 107
103137	261, 263	103672	247	104118	34	146254	104, 107
103138	262, 263	103673	247	104178	33	146256	104, 107
103139	262, 263	103680	240	104186	32	146257	85, 104, 107
103140	262, 263	103681	241	104192	38	146258	104
103141	262, 263	103682	242	104196	37	146260	104
103152	261, 263	103684	229	104257	221, 231	146261	104
103153	261, 263	103685	229	104271	261, 263	146262	104
103157	261, 263	103686	229	104272	261, 263	146264	104
103158	261, 263	103687	229	104317	121	146265	104
103164	85, 126	103688	221, 229	104319	128	146266	104
103165	127	103734	231	104361	250	146268	85, 104
103166	85, 122, 123, 210, 255	103735	245	104362	245	146269	104
103167	124, 125	103817	86, 100	104363	245	146270	104
103168	85, 117, 118, 210, 255	103893	237	104438	234	146272	104
103169	119, 120	103894	237	104439	234	146273	104
103171	213	103895	239	104450	221, 248	146274	102, 107
103185	107	103896	239	104477	29	146276	102, 107
103186	107	103897	231	104479	221, 222, 253	146277	102, 107
103233	147	103900	233	104480	221, 222, 253	146278	102, 107
103239	107	103901	233	104481	221, 222, 253	146280	102, 107
103240	107	103902	229	104482	221, 223	146281	85, 102, 107
103264	193, 201	103903	229	104483	224	146282	102
103268	259	103904	247	104500	241	146284	102
103291	199	103908	245	104503	239	146285	102
103321	107	103911	39	104505	254	146286	102
103322	107	103916	35	104506	254	146288	102
103327	107	103944	237	104549	44	146289	102
103328	107	103945	237	104550	45	146290	102
103336	85, 146	103946	237	104583	282	146292	102
103340	261, 263	103947	237	104584	282	146293	85, 102
103341	261, 263	103948	237	104652	15	146294	102
103349	281	103949	237	104655	16	146296	102
103350	281	103950	239	104656	16	146297	102
103361	116	103951	239	104666	30	146304	85, 103
103414	85, 115	103952	239	104693	16	146305	103
103455	213	103953	239	104744	40	146306	85, 103
103542	85, 147	103954	239	104804	28	146307	103
103577	85, 163	103955	239	104809	249	146308	85, 105
103634	247	103956	231	104891	22	146309	105
103635	247	103957	231	104892	21	146310	105
		103958	231	104893	21	146311	105
		103959	231	104894	19	146315	202

Part Number Index (Continued)

Part No.	Page	Part No.	Page	Part No.	Page	Part No.	Page
146386	175	146852	107	147740	192	1375582	252
146427	85	146853	107	147741	192	1375583	252
146455	112	146858	107	147742	187	1375791	7, 12
146456	112	146859	107	147743	187	1375792	7
146457	112	146860	107	147744	187	1375793	7, 12
146458	112	146861	107	147745	190	1375794	7
146459	112	146868	107	147746	190	1375795	6, 12
146460	112	146869	107	147747	190	1375796	6
146461	112	146870	107	173144	155, 156	1375797	9
146462	112	146871	107	173145	155, 157, 158, 159	1375798	9
146463	112	147030	235	173146	155, 160, 161	1375799	8
146464	112	147070	86, 167	219054	58	1375800	8
146465	112	147071	167	219055	58	1375801	12
146466	112	147072	167	219137	58	1375959	10
146467	112	147095	183, 184	219138	58	1375961	10
146468	112	147096	183, 184	219253	58	1375963	10
146469	112	147099	182	382575	309	1375965	11
146470	112	147100	182	382811	308	1375967	11
146471	112	147101	190	390088	309	1445251	12
146472	112	147102	190	390102	310	1445439	12
146473	112	147103	190	487544	50	1445440	12
146474	86, 112	147104	192	487545	50	1445441	12
146475	112	147105	86, 192	487547	48	1470108	79
146476	112	147106	192	487576	54	1470109	78
146477	112	147121	16	487923	48	1470209	80
146478	112	147254	202	487937	52	1470213	66
146479	112	147278	251	487938	52	1734493	75
146480	112	147323	251	487940	48	1734506	81
146481	112	147324	251	487941	48	1734507	67
146482	112	147326	177	499991	205	1734508	66
146483	113	147333	86, 165	530153	310	1734516	84
146484	113	147334	165	530554	267	1734531	83
146485	113	147335	165	530901	269	1734569	77
146486	113	147377	44	530902	268	1734606	82
146487	113	147378	45	531226	267, 268	1734770	73
146488	113	147381	16	531230	308	1825190	307
146489	113	147382	16	532955	195	1825851	139, 140, 210
146490	85, 113	147383	16	532956	193, 195	2041068	76
146491	113	147384	15	533009	195	2041069	84
146492	113	147396	235	534204	195	5084476	71
146493	113	147413	15	534206	85, 176	5084780	74
146494	113	147424	176	534237	85, 175	5086147	294
146495	113	147433	165	534245	200	5086182	294
146496	113	147434	165	534257	198	5102084	170
146497	113	147435	165	534258	201	5102154	139, 210, 255
146498	113	147436	167	534267	85, 182	5102156	139
146499	113	147437	167	534972	193, 196	5102160	140
146500	113	147438	167	534974	193, 197	5102162	140
146501	113	147503	16	534975	195	5103308	135
146502	113	147720	86, 181	534978	198	5103309	135
146503	113	147723	188	534998	85, 179, 180	5103310	136
146504	113	147724	187	535541	85, 178	5103311	136
146505	113	147726	181	535542	86, 183, 184	5104338	137
146506	113	147727	181	535584	178	5104340	138
146507	113	147728	188	535585	179, 180	5111595	57
146508	113	147729	188	535598	179, 180	5146139	169
146509	113	147730	187	746383	139, 140	5146140	170
146510	113	147731	187	867052	207	5147721	86, 172
146762	176	147736	188	880584	309	5147722	86, 173
146763	175	147737	188	881545	309	5147732	172
146850	107	147738	86, 188	966926	72	5147733	172
146851	107	147739	192	1375549	252	5147734	173

Part Number Index (Continued)

Part No.	Page	Part No.	Page	Part No.	Page	Part No.	Page
5147735	173	5178751	70	5531216	269	5535512	85, 170
5176264	70	5530553	269	5531224	269	5535676	85, 169
5176837	68	5530901	269	5531225	269	5535677	169

Tooling Part Number Index

Note: This index lists all cataloged parts by base no. only. Complete part nos. (with prefixes and/or suffixes) are shown on the page(s) indicated.

Part No.	Page	Part No.	Page	Part No.	Page
58062	273	104072	253	527116	263
58074	273	217600	153, 164, 166, 303	543518	23
58075	273	224910	48, 60	547178	301
58336	273	265871	152	565967	286
58338	273	265964	152	567239	254
58342	254	308554	152	567296	222, 253
58395	273	312522	274	567297	222, 253
58540	273	318619	48, 60	567298	222, 253
58641	211, 213	354500	300	567307	211
90273	60	354786	275	567310	207
90274	290	356484	60	662820	303
90295	207	356500	300	679167	62
90308	298	380392	152	679996	207
90328	290	466007	298	758030	162
90381	211	466376	286	761420	275
90431	207	466562	213	768338	62
91047	60	466571	213	812665	263
91084	207	466655	213	843473	290
91085	62	466721	207	843477	253, 254, 265
91104	298	466723	269	843996	214, 215, 216, 217, 218, 219, 220
91112	62	466763	290	854040	301
91169	152	466764	290	854449	274
91170	152	466812	211	856002	274
91171	152	466819	269	856675	273
91200	60	466905	213	904507	163
91295	23	466918	213	904590	163
91410	263	466921	213	904591	163
91419	163	466937	290	904592	163
91516	213	466943	269	904640	166
91517	211, 213	466950	298	904641	164
91518	222, 253	466952	269	907459	162
91531	254	466980	222, 253	931800	273
91533	207	466981	222, 253	1213400	300
91541	213	466982	222, 253		
91551	222, 253	466983	254		

Engineering Notes



Engineering Notes



Americas

Argentina – Buenos Aires
Phone: +54-11-4733-2200
Fax: +54-11-4733-2211

Brasil – São Paulo
Phone: +55-11-2103-6000
Fax: +55-11-2103-6030

Chile – Santiago
Phone: +56-2-345-0361
Fax: +56-2-223-1477

Canada – Toronto
Phone: +905-475-6222
Fax: +905-474-5520
Product Information Center:
Phone: +905-470-4425
Fax: +905-474-5525

Colombia – Bogota
Phone: +57-1-319-8959
Fax: +57-1-319-8960

Mexico – Mexico City
Phone: +52-55-1106-0800
+01-800-733-8926
Fax: +52-55-1106-0901

For Latin/South American Countries not shown
Phone: +54-11-4733-2015
Fax: +54-11-4733-2083

United States
Harrisburg, PA
Phone: +1-717-564-0100
Fax: +1-717-986-7575
Product Information Center:
Phone: +1-800-522-6752
Fax: +1-717-986-7575
Troy, MI
Phone: +1-248-273-3359
Fax: +1-248-273-3322

Asia/Pacific

Australia – Sydney
Phone: +61-2-9554-2600
Fax: +61-2-9502-2556
Product Information Center:
Phone: +61-2-9840-8200
Fax: +61-2-9634-6188

India – Bangalore
Phone: +91-80-285-40800
Fax: +91-80-285-40820

Indonesia – Jakarta
Phone: +65-6482-0311
Fax: +65-6482-1012

Japan – Kawasaki, Kanagawa
Phone: +81-44-844-8111
Fax: +81-44-812-3207
Product Information Center:
Phone: +81-44-844-8013
Fax: +81-44-812-3200

Korea – Seoul
Phone: +82-2-3415-4500
Fax: +82-2-3486-3810

Malaysia – Selangor
Phone: +60-3-7805-3055
Fax: +60-3-7805-3066

New Zealand – Auckland
Phone: +64-9-634-4580
Fax: +64-9-634-4586

Philippines – Makati City
Phone: +632-848-0171
Fax: +632-867-8661

People's Republic of China
Hong Kong
Phone: +852-2735-1628
Fax: +852-2735-0243
Shanghai
Phone: +86-21-2407-1588
Fax: +86-21-2407-1599

Singapore – Singapore
Phone: +65-6482-0311
Fax: +65-6482-1012

Taiwan – Taipei
Phone: +886-2-8768-2788
Fax: +886-2-8768-2268

Thailand – Bangkok
Phone: +66-2-955-0500
Fax: +66-2-955-0505

Vietnam – Ho Chi Minh City
Phone: +84-8-930-5546
Fax: +84-8-930-3443

Europe/Middle East/Africa

Austria – Vienna
Phone: +43-1-905-60-0
Fax: +43-1-905-60-1333
Product Information Center:
Phone: +43-1-905-60-1249
Fax: +43-1-905-60-1251

Belarus – Minsk
Phone: +375 17 237 47 94
Fax: +375 17 237 47 94

Belgium – Kessel-Lo
Phone: +32-16-352-300
Fax: +32-16-352-355

Bulgaria – Sofia
Phone: +359-2-971-2152
Fax: +359-2-971-2153

Czech Republic and Slovakia
Czech Republic – Kurim
Phone: +420-541-162-111
Fax: +420-541-162-223
Product Information Center:
Phone: +420-541-162-113
Fax: +420-541-162-132

Denmark – Glostrup
Phone: +45-43-48-04-00
Fax: +45-43-44-14-14

Egypt – Cairo
Phone: +202-419-2334
Fax: +202-417-7647

Estonia – Tartu
Phone: +372-5138-274
Fax: +372-7400-779

Finland – Helsinki
Phone: +358-95-12-34-20
Fax: +358-95-12-34-250

France – Cergy-Pontoise Cedex
Phone: +33-1-3420-8888
Fax: +33-1-3420-8600
Product Information Center:
Phone: +33-1-3420-8686
Fax: +33-1-3420-8623

France Export Divisions –
Cergy-Pontoise Cedex
Phone: +33-1-3420-8804
Fax: +33-1-3420-8699

Germany – Bensheim
Phone: +49-6251-133-0
Fax: +49-6251-133-1600
Product Information Center:
Phone: +49-6251-133-1999
Fax: +49-6251-133-1988

Greece – Athens
Phone: +30-210-9370-396/397
Fax: +30-210-9370-655

Hungary – Budapest
Phone: +36-1-289-1000
Fax: +36-1-289-1010
Product Information Center:
Phone: +36-1-289-1016
Fax: +36-1-289-1017

Ireland – Dublin
Phone: +353-1-866-5612
Fax: +353-1-866-5714

Israel – Petach-Tikva
Phone: +972-3-929-0999
Fax: +972-3-919-1088

Italy – Collegno (Torino)
Phone: +39-011-4012-111
Fax: +39-011-4031-116
Product Information Center:
Phone: +39-011-4012-428
Fax: +39-011-40-287-428

Lithuania and Latvia
Lithuania – Vilnius
Phone: +370-5-213-1402
Fax: +370-5-213-1403
Product Information Center:
Phone: +370-5-211-3016
Fax: +370-5-213-1403

Netherlands – 's-Hertogenbosch
Phone: +31-73-6246-246
Fax: +31-73-6212-365
Product Information Center:
Phone: +31-73-6246-999
Fax: +31-73-6246-998

Norway – Nesbru
Phone: +47-66-77-88-50
Fax: +47-66-77-88-55

Poland – Warsaw
Phone: +48-22-4576-700
Fax: +48-22-4576-720
Product Information Center:
Phone: +48-22-4576-704
Fax: +48-22-4576-720

Romania – Bucharest
Phone: +40-21-311-3479/3596
Fax: +40-21-312-0574

Russia – Moscow
Phone: +7-495-790-7902
Fax: +7-495-721-1893
Product Information Center:
Phone: +7-495-790-7902-404
Fax: +7-495-790-7902-401

Russia – St. Petersburg
Phone: +7-812-718-8192
Fax: +7-812-718-8193

Slovenia – Ljubljana
Phone: +386-1561-3270
Fax: +386-1561-3240

South Africa – Port Elizabeth
Phone: +27-41-503-4500
Fax: +27-41-581-0440

Spain – Barcelona
Phone: +34-93-291-0330
Fax: +34-93-201-7879

Sweden – Upplands Väsby
Phone: +46-8-50-72-50-00
Fax: +46-8-50-72-50-01

Switzerland – Steinach
Phone: +41-71-447-0447
Fax: +41-71-447-0444

Turkey – Istanbul
Phone: +90-212-281-8181/2/3
+90-212-282-5130/5430
Fax: +90-212-281-8184

Ukraine – Kiev
Phone: +380-44-206-2265
Fax: +380-44-206-2264
Product Information Center:
Phone: +380-44-206-2265
Fax: +380-44-206-2264

United Kingdom –
Stanmore, Middlesex
Phone: +44-8706-080208
Fax: +44-208-954-6234
Product Information Center:
Freephone (UK only):
0800-267-666
Phone: +44-8706-080208
Fax: +44-208-420-8095

Tyco Electronics Corporation
Harrisburg, PA

tycoelectronics.com

1307819-7.5M-LUG-FP-8-08

