

4.2 mm PE Series Connector System

(Wire-to-Wire, Wire-to-Board and Wire-to-Panel)

DESCRIPTION

- Low cost, wire-to-wire, wire-to-board and wire-to-panel connectors with 4.2 mm centerline

APPLICATIONS

- Computer motherboards/power supplies
- Harness assemblies used in the Vending, Gaming and Appliance industries
- Car alarm systems
- Heating systems

KEY FEATURES

- Easy mate and unmate with positive latch design
- Single-row, 3-5 positions: receptacles, panel mount or free-hanging plugs
- Double-row, 2-24 positions (even only): receptacles, panel mount or free-hanging plugs, and vertical or right-angle pin headers
- Available in UL 94V-2 or UL 94V-0 flammability rated nylon
- Products are lead free to help promote a cleaner environment
- Intermateable and interchangeable with Molex Mini-Fit, Jr. and intermateable AMP-DUAC connectors

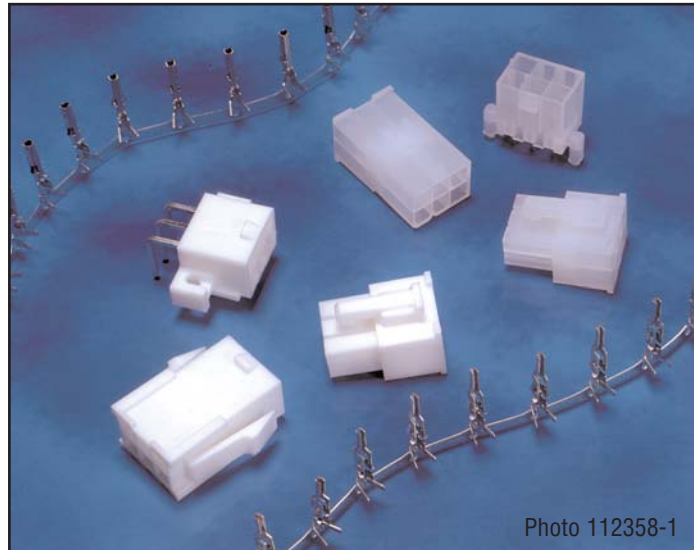

Photo 112358-1

Revised 06/04 1309245

ELECTRICAL

- Voltage: 600 VAC
- Current: 9 amps max. in 2-position applications
- Dielectric Withstanding Voltage: 1500 VAC min.
- Insulation Resistance: 1000 megohms min.

MECHANICAL

- Connector Mating: 1.55 lb. [6.90 N] max. per circuit
- Connector Unmating: .11 lb. [.49 N] min. per circuit
- Contact Retention: 4.88 lb. [21.71 N] min. per contact
- Durability: 50 cycles, mating and unmating

MATERIALS

- Housings: Nylon, UL 94V-2 and UL 94V-0
- Contacts: Brass or Phos. Bronze with tin plating (Lead-Free) or gold plating

STANDARDS & SPECS

- Component Recognized by UL and Certified by CSA
- UL File No. E28476 and CSA File No. 208567
- Tyco Electronics Design For Environment (DFE) Standard 230-5

FOR MORE INFORMATION

Technical Support

Phone: 1-800-522-6752

Internet: www.tycoelectronics.com

E-mail:

newproducts@tycoelectronics.com

USA: 1-800-522-6752

Canada: 1-905-470-4425

Mexico: 01-800-733-8926

C. America: 52-55-5-792-0425

South America: 55-11-3611-1514

Hong Kong: 852-2735-1628

Japan: 81-44-844-8013

UK: 44-141-810-8967

new product

4.2 mm PE Series Connector System

(Wire-to-Wire, Wire-to-Board and Wire-to-Panel)

HOUSINGS □ PRODUCT OFFERING & DIMENSIONS

SINGLE ROW

| No. of Positions | UL 94V-2 Housings | | | UL 94V-0 Housings | | |
|------------------|-------------------|-------------------|--------------------|-------------------|-------------------|--------------------|
| | Panel Mount Plug | Free-Hanging Plug | Receptacle Housing | Panel Mount Plug | Free-Hanging Plug | Receptacle Housing |
| 3* | 1586101-3 | 1586103-3 | 1586105-3 | 1586102-3 | 1586104-3 | 1586106-3 |
| 4 | 1586022-4 | 1586024-4 | 1586026-4 | 1586023-4 | 1586025-4 | 1586027-4 |
| 5 | 1586022-5 | 1586024-5 | 1586026-5 | 1586023-5 | 1586025-5 | 1586027-5 |

*Note: 3 position housings are First Mate/Last Break.

Panel Mount Plug Housing

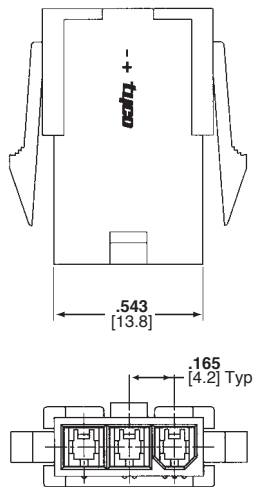

Receptacle Housing

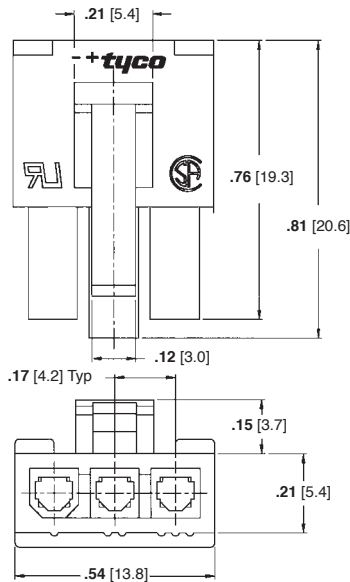

Free-Hanging Plug Housing

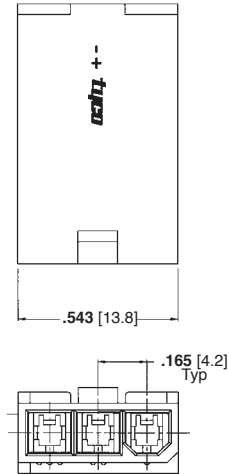

DOUBLE ROW

| No. of Positions | UL 94V-2 Housings | | | UL 94V-0 Housings | | |
|------------------|-------------------|-------------------|--------------------|-------------------|-------------------|--------------------|
| | Panel Mount Plug | Free-Hanging Plug | Receptacle Housing | Panel Mount Plug | Free-Hanging Plug | Receptacle Housing |
| 2 | 794953-2 | 1586000-2 | 794954-2 | 1586018-2 | 1586017-2 | 1586019-2 |
| 4 | 794953-4 | 1586000-4 | 794954-4 | 1586018-4 | 1586017-4 | 1586019-4 |
| 6 | 794953-6 | 1586000-6 | 794954-6 | 1586018-6 | 1586017-6 | 1586019-6 |
| 8 | 794953-8 | 1586000-8 | 794954-8 | 1586018-8 | 1586017-8 | 1586019-8 |
| 10 | 1-794953-0 | 1-1586000-0 | 1-794954-0 | 1-1586018-0 | 1-1586017-0 | 1-1586019-0 |
| 12 | 1-794953-2 | 1-1586000-2 | 1-794954-2 | 1-1586018-2 | 1-1586017-2 | 1-1586019-2 |
| 14 | 1-794953-4 | 1-1586000-4 | 1-794954-4 | 1-1586018-4 | 1-1586017-4 | 1-1586019-4 |
| 16 | 1-794953-6 | 1-1586000-6 | 1-794954-6 | 1-1586018-6 | 1-1586017-6 | 1-1586019-6 |
| 18 | 1-794953-8 | 1-1586000-8 | 1-794954-8 | 1-1586018-8 | 1-1586017-8 | 1-1586019-8 |
| 20 | 2-794953-0 | 2-1586000-0 | 2-794954-0 | 2-1586018-0 | 2-1586017-0 | 2-1586019-0 |
| 22 | 2-794953-2 | 2-1586000-2 | 2-794954-2 | 2-1586018-2 | 2-1586017-2 | 2-1586019-2 |
| 24 | 2-794953-4 | 2-1586000-4 | 2-794954-4 | 2-1586018-4 | 2-1586017-4 | 2-1586019-4 |

Note: Plug housings accept pin contacts and receptacle housings accept socket contacts on page 4.

Panel Mount Plug Housing

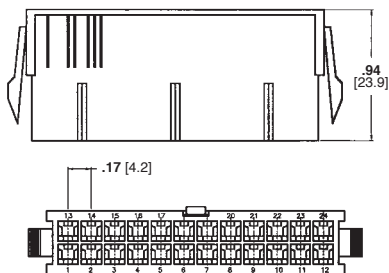

Receptacle Housing

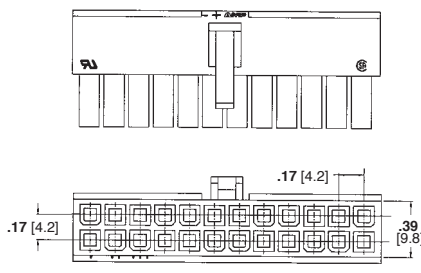

Free-Hanging Plug Housing

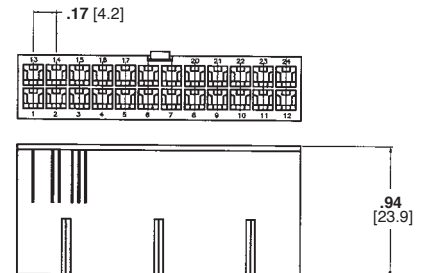

4.2 mm PE Series Connector System

(Wire-to-Wire, Wire-to-Board and Wire-to-Panel)

PIN HEADERS □ PRODUCT OFFERING

| No. of Positions | UL 94V-2 Pin Headers | | | | UL 94V-0 Pin Headers | | | |
|------------------|----------------------|-------------|-------------|-------------|----------------------|-------------|-------------|-------------|
| | Vertical | | Right-Angle | | Vertical | | Right-Angle | |
| | w/o Pegs | w/Pegs | w/o Pegs | Screw Mount | w/o Pegs | w/Pegs | w/o Pegs | Screw Mount |
| 2 | 1586037-2 | 1586039-2 | 1586041-2 | 1586043-2 | 1586038-2 | 1586040-2 | 1586042-2 | 1586044-2 |
| 4 | 1586037-4 | 1586039-4 | 1586041-4 | 1586043-4 | 1586038-4 | 1586040-4 | 1586042-4 | 1586044-4 |
| 6 | 1586037-6 | 1586039-6 | 1586041-6 | 1586043-6 | 1586038-6 | 1586040-6 | 1586042-6 | 1586044-6 |
| 8 | 1586037-8 | 1586039-8 | 1586041-8 | 1586043-8 | 1586038-8 | 1586040-8 | 1586042-8 | 1586044-8 |
| 10 | 1-1586037-0 | 1-1586039-0 | 1-1586041-0 | 1-1586043-0 | 1-1586038-0 | 1-1586040-0 | 1-1586042-0 | 1-1586044-0 |
| 12 | 1-1586037-2 | 1-1586039-2 | 1-1586041-2 | 1-1586043-2 | 1-1586038-2 | 1-1586040-2 | 1-1586042-2 | 1-1586044-2 |
| 14 | 1-1586037-4 | 1-1586039-4 | 1-1586041-4 | 1-1586043-4 | 1-1586038-4 | 1-1586040-4 | 1-1586042-4 | 1-1586044-4 |
| 16 | 1-1586037-6 | 1-1586039-6 | 1-1586041-6 | 1-1586043-6 | 1-1586038-6 | 1-1586040-6 | 1-1586042-6 | 1-1586044-6 |
| 18 | 1-1586037-8 | 1-1586039-8 | 1-1586041-8 | 1-1586043-8 | 1-1586038-8 | 1-1586040-8 | 1-1586042-8 | 1-1586044-8 |
| 20 | 2-1586037-0 | 2-1586039-0 | 2-1586041-0 | 2-1586043-0 | 2-1586038-0 | 2-1586040-0 | 2-1586042-0 | 2-1586044-0 |
| 22 | 2-1586037-2 | 2-1586039-2 | 2-1586041-2 | 2-1586043-2 | 2-1586038-2 | 2-1586040-2 | 2-1586042-2 | 2-1586044-2 |
| 24 | 2-1586037-4 | 2-1586039-4 | 2-1586041-4 | 2-1586043-4 | 2-1586038-4 | 2-1586040-4 | 2-1586042-4 | 2-1586044-4 |

Note: All Headers have Brass, Tin-Plated contacts.

PRODUCT DIMENSIONS

Vertical Pin Headers (Part No. 1586037 shown w/o pegs)

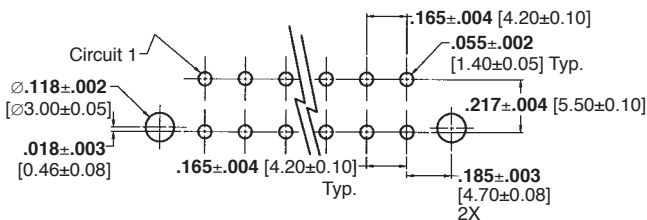
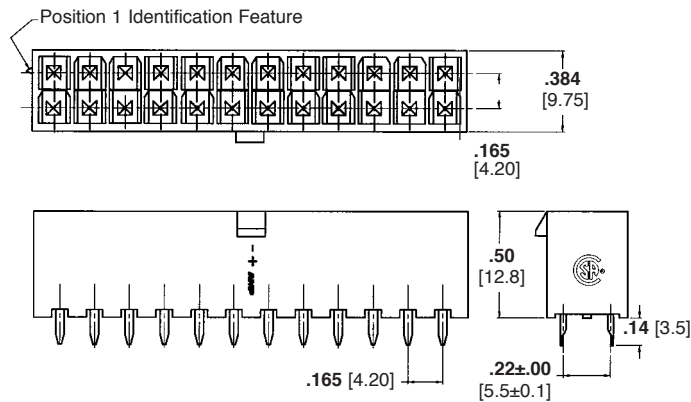

PCB Layout: Component Side (shown with pegs)
Recommended Board Thickness .070 [1.78]

Right-Angle Pin Headers (Part No. 1586043 Screw Mount)

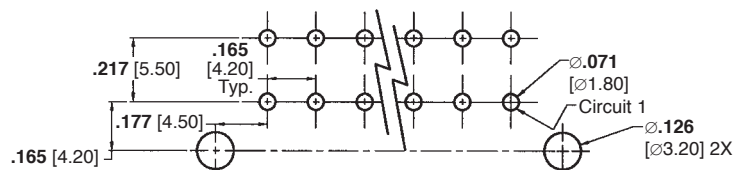
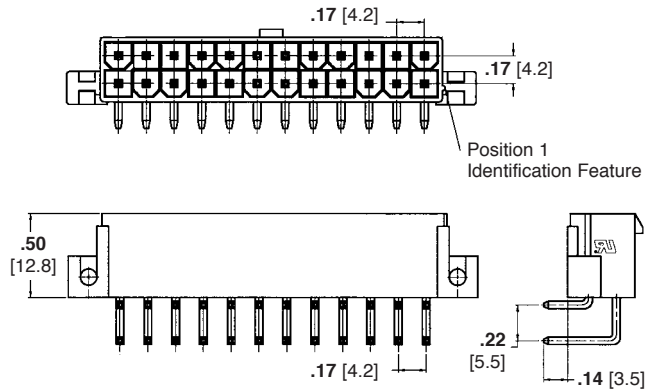

PCB Layout: Component Side (screw mount shown)
Recommended Board Thickness .063 [1.60]

4.2 mm PE Series Connector System

(Wire-to-Wire, Wire-to-Board and Wire-to-Panel)

CONTACTS □ PRODUCT OFFERING

| Wire Range (AWG) | Material & Finish | Pin | | Socket | | Applicator Part Number ¹ | Hand Tool Part Number |
|---------------------|----------------------|------------|------------|------------|------------|--|--------------------------|
| | | Strip Form | Loose Form | Strip Form | Loose Form | | |
| 26-22 | Brass, Pre-Tin | 794957-1 | 1586316-1 | 794958-1 | 1586317-1 | 1385448-X | 91387-1 |
| | Phos. Brz., Pre-Tin | 794957-3 | 1586316-3 | 794958-3 | 1586317-3 | | |
| | Brass, Gold | 794957-2 | 1586316-2 | 794958-2 | 1586317-2 | | |
| | Phos. Brz., Gold | 794957-4 | 1586316-4 | 794958-4 | 1586317-4 | | |
| 22-18 | Brass, Pre-Tin | 794955-1 | 1586314-1 | 794956-1 | 1586315-1 | 680557-X | 91388-1 |
| | Phos. Brz., Pre-Tin | 794955-3 | 1586314-3 | 794956-3 | 1586315-3 | | |
| | Brass, Gold | 794955-2 | 1586314-2 | 794956-2 | 1586315-2 | | |
| | Phos. Brz., Gold | 794955-4 | 1586314-4 | 794956-4 | 1586315-4 | | |

Extraction Tool Part Number 1586343-1

¹ For applicator and machine part numbers, contact Technical Support.

SOCKET
(used in Receptacle Housing)

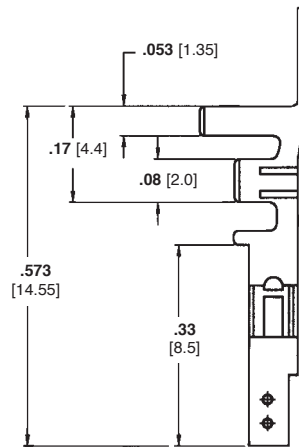

PIN
(used in Plug Housing)

