



(1,27mm) .050"

FFSD, FFMD SERIES

FFSD-20-S-10.00-01-N



FFMD-20-T-02.00-01-N-R

# TIGER EYE™ FLAT IDC WIRE CABLES

## SPECIFICATIONS

**Mates with:**

FTS, FTSH, EHF, SHF, ESHF

For complete specifications see [www.samtec.com?FFSD](http://www.samtec.com?FFSD)

**FFSD**

**Insulator Material:** PBT



**Contact:**

BeCu

**Plating:**

10µ" (0,25µm) Au over 50µ" (1,27µm) Ni on contact area; Sn over 50µ" (1,27µm) Ni on balance

**Wire:**

30 AWG

**Current Rating:**

0.5A

**Operating Temp Range:**

-40°C to +105°C

**Lead Size Accepted:**

(0,41mm) .016" SQ

**Contact Resistance:**

15 mΩ maximum delta from initial

**Insertion Depth:**

(2,64mm) .104" to (3,17mm) .125"

**Insertion Force:**

(Single contact only) 5oz (1,39N) avg.

**Withdrawal Force:**

(Single contact only) 3oz (0,83N) avg.

**RoHS Compliant:**

Yes

**Note:** This Series is non-standard, non-returnable.

## SPECIFICATIONS

**Mates with:**

FLE\*, SFMC\*

For complete specifications see [www.samtec.com?FFMD](http://www.samtec.com?FFMD)

**FFMD**

**Insulator Material:** Black Glass Filled Polyester



**Terminal:**

BeCu

**Plating:**

Sn over 50µ" (1,27µm) Ni

**Wire:**

30 AWG

**Current Rating:**

0.5A

**Operating Temp Range:**

-40°C to +105°C

**RoHS Compliant:**

Yes

**\*Note:** Standard FFMD callout will not mate with FLE, SFMC. Must use gold plated callouts. (See drawing on web.)

When mated with a socket, Wire 1 mates with Pin 2; Wire 2 mates with Pin 1, etc.

**Note:** This Series is non-standard, non-returnable.

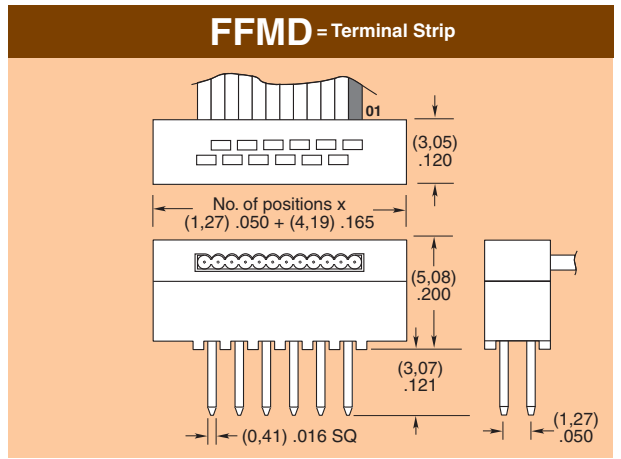
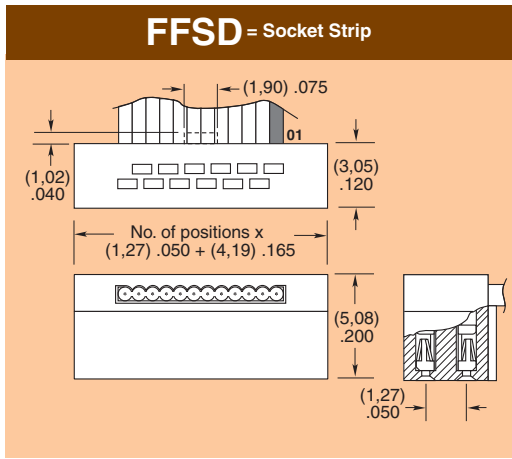
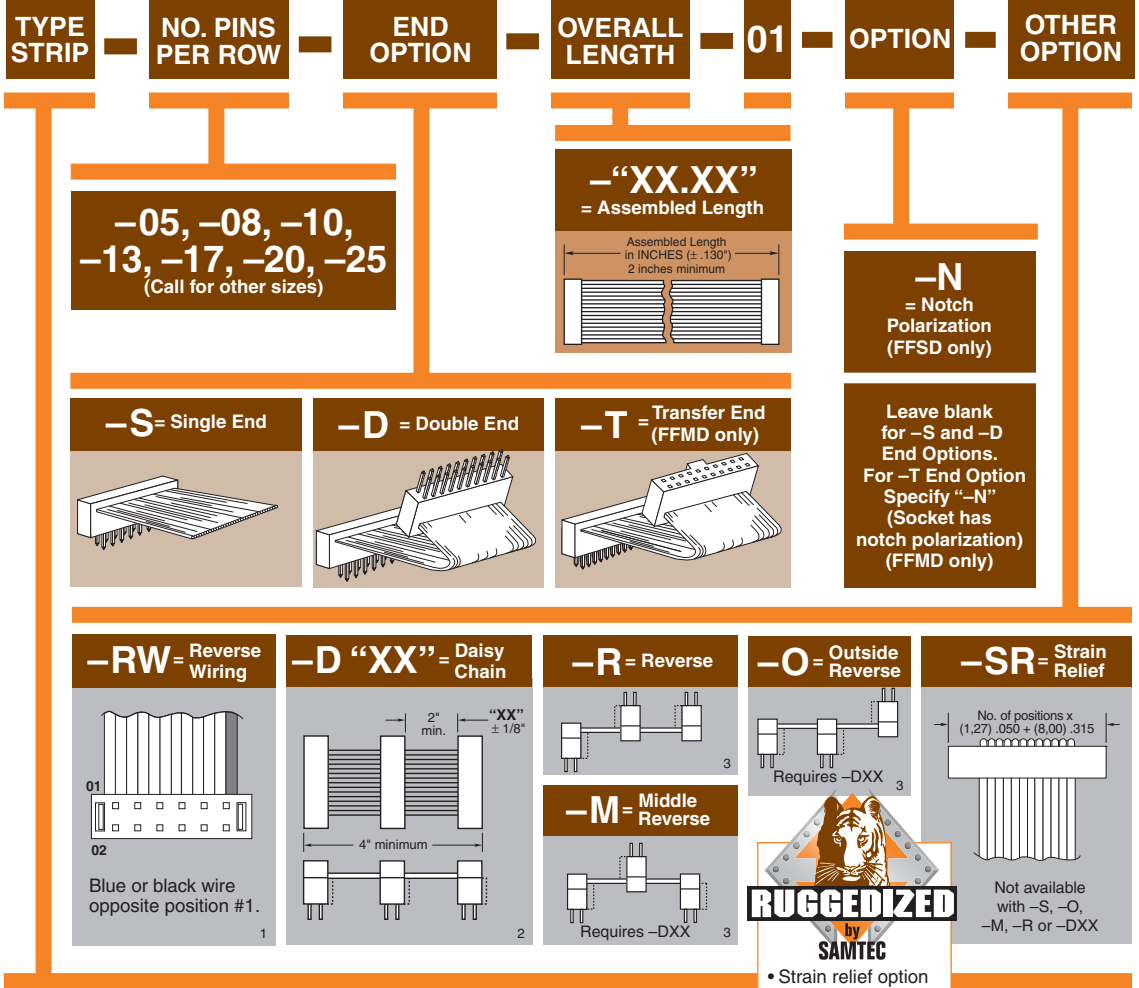

Due to technical progress, all designs, specifications and components are subject to change without notice.

[WWW.SAMTEC.COM](http://WWW.SAMTEC.COM)

SAMTEC USA • Tel: 1-800-SAMTEC-9 or 812-944-6733 SAMTEC SILICON VALLEY • Tel: 408-395-5900 SAMTEC SOUTHERN CALIFORNIA • Tel: 1-800-726-8329  
 SAMTEC AMERICA LATINA COMERCIO EXTERIOR LTDA • Tel: (+55 31) 3786 3227 SAMTEC UNITED KINGDOM • Tel: 44 01236 739292 SAMTEC GERMANY • Tel: +49 (0) 89 / 89460-0  
 SAMTEC FRANCE • Tel: 33 01 60 95 06 60 SAMTEC ITALY • Tel: 39 039 8690337 SAMTEC NORDIC/BALTIC • Tel: +46-84477280 SAMTEC BENELUX • Tel: 44 01236 739292 SAMTEC ISRAEL • Tel: 972-3-7526600  
 SAMTEC INDIA • Tel: +91-80-3272 1612 SAMTEC ASIA PACIFIC • Tel: 65 6745-5955 SAMTEC JAPAN • Tel: 045-475-1385 SAMTEC CHINA • Tel: 86-21-61103766 SAMTEC TAIWAN • Tel: 886-2-2735-6109  
 SAMTEC HONG KONG • Tel: 852-2600-9858 SAMTEC KOREA • Tel: 82-31-717-5685 SAMTEC ANZ • Tel: 613 9512 7747 SAMTEC SOUTH AFRICA • Tel: 27 11 452 8112