

Mil-Spec Connectors & Accessories



DEUTSCH ECD

Defense / Aerospace Operations ...

is the world's premier manufacturer of electrical interconnection devices for use in defense, aerospace, and commercial applications. Whether you need an interconnection device for a commercial or military aircraft, missile, tank, truck transmission or a host of other applications, Deutsch has the solution you're looking for.

Deutsch ECD Defense Aerospace Operations

5733 W. Whittier Ave., Hemet CA (USA) 92545
Phone 909/765-2200 • FAX 909/922-1544

MIL-C-38999 Series III (Composite)

ACT Highlights

DEUTSCH ACT SERIES

The Deutsch ACT is a high performance composite connector qualified to MIL-C-38999. What Deutsch Defense/Aerospace does better than anyone else is make wire termination devices for demanding applications. Deutsch utilized its unprecedented achievements in the area of defense/aerospace composite technology, enabling us to design and produce the latest version of MIL-C-38999 connectors.

The superior design of the ACT deliberately took into consideration the connector, its contacts, and the respective strain reliefs to favorably influence intra-system life-cycle performance and costs.

Performance

The total performance of the ACT connector is matched by individual components within the system. For example, the use of composite materials has increased the durability of the connector housing and coupling mechanism to 1500 cycles. Deutsch developed an extended life MIL-C-39029 contact to meet the increased performance requirements of today's systems.

Superior corrosion resistance

The ACT eliminates the largest contributing factor in advanced systems malfunction... corrosion, which is the main cause of mechanical, electrical, and electromagnetic connector degradation. Electromotive force differentials between many dissimilar metals found in connectors and accessories produce galvanic action. The ACT eliminates these dissimilar metals, resulting in an interconnection system that withstands over 2000 hours of salt spray.

EMI shielding effectiveness

Meets and exceeds the requirements of MIL-C-38999, paragraph 3.3.1.

Fluid immersion

Meets all the requirements of MIL-C-38999, paragraph 3.33.

Temperature

The metal surface will not delaminate from the composite material even after extreme temperature excursions. The ACT meets all requirements of MIL-C-38999, paragraph 3.8.

Magnetic permeability

The magnetic permeability of the fully assembled ACT connector is less than 2.0μ , meeting all the requirements of MIL-C-38999, paragraph 3.3.4.

Materials

All the materials used in the shell and inserts in the ACT are in accordance with MIL-C-38999, paragraph 3.3. The contacts are in accordance with MIL-C-39029, paragraph 3.3.

Finish

Meets all the requirements of MIL-C-38999, paragraph 3.4.8.

Insulation resistance

Meets all the requirements of MIL-C-38999, paragraph 3.13.

Dielectric withstanding voltage

Meets all the requirements of MIL-C-38999, paragraph 3.14.



mil38999_ser3_composite

This information is for reference only. Consult factory for envelope drawings, updated specifications, and additions to the product line.

©Copyright 2001 Deutsch ECD

The Best of MIL-C-38999

Square flange receptacle*

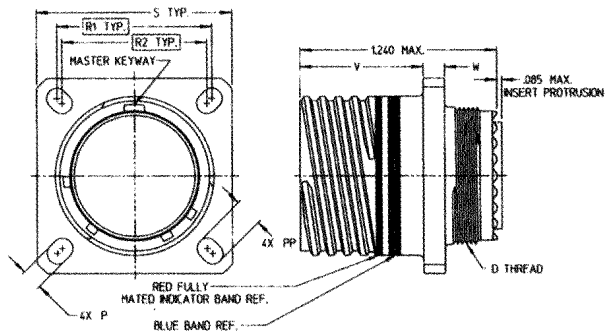

MILITARY PART NUMBERS	DEUTSCH PART NO.	SHELL SIZE	D THREAD	P+.004 -.002	PP+.004 -.002	R1	R2	S.010	Y MIN	W MAX.
D38999/20*A****	ACT 90*A****	A (9)	M12X1.0-8g 0.100R	.128	.216	.719	.594	.937	.768	.144
D38999/20*B****	ACT 90*B****	B (11)	M15X1.0-8g 0.100R	.128	.194	.812	.719	1.031	.768	.144
D38999/20*C****	ACT 90*C****	C (13)	M18X1.0-8g 0.100R	.128	.194	.906	.812	1.128	.768	.144
D38999/20*D****	ACT 90*D****	D (15)	M22X1.0-8g 0.100R	.128	.173	.969	.906	1.220	.768	.144
D38999/20*E****	ACT 90*E****	E (17)	M25X1.0-8g 0.100R	.128	.194	1.062	.969	1.311	.768	.144
D38999/20*F****	ACT 90*F****	F (19)	M28X1.0-8g 0.100R	.128	.194	1.156	1.062	1.437	.768	.144
D38999/20*G****	ACT 90*G****	G (21)	M31X1.0-8g 0.100R	.128	.194	1.250	1.156	1.563	.736	.171
D38999/20*H****	ACT 90*H****	H (23)	M34X1.0-8g 0.100R	.154	.242	1.375	1.250	1.689	.736	.171
D38999/20*J****	ACT 90*J****	J (25)	M37X1.0-8g 0.100R	.154	.242	1.500	1.375	1.811	.736	.171

Mounting cutouts

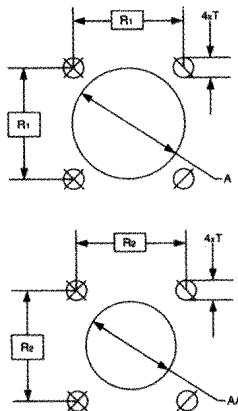

Back Panel Mounting

Max (R1) distance between mounting screws

Front Paneling Mounting

Max (R2) distance between mounting screws

SHELL SIZE	A DIS. MIN.	AA DIS. MIN.	R1	R2	T DIA. ±.13
A (9)	18.68 (.659)	13.11 (.516)	18.26 (.719)	15.09 (.594)	3.25 (.128)
B (11)	20.22 (.795)	15.88 (.625)	20.62 (.812)	18.26 (.719)	3.25 (.128)
C (13)	23.42 (.922)	19.05 (.750)	23.01 (.906)	20.62 (.812)	3.25 (.128)
D (15)	26.59 (1.047)	23.01 (.906)	24.61 (.969)	23.01 (.906)	3.25 (.128)
E (17)	30.96 (1.219)	25.81 (1.018)	26.97 (1.062)	24.61 (.969)	3.25 (.128)
F (19)	32.94 (1.297)	28.95 (1.141)	29.36 (1.156)	26.97 (1.062)	3.25 (.128)
G (21)	36.12 (1.442)	32.16 (1.266)	31.75 (1.250)	29.36 (1.156)	3.25 (.128)
H (23)	39.29 (1.547)	34.93 (1.375)	34.93 (1.375)	31.75 (1.250)	3.91 (.154)
J (25)	42.47 (1.672)	37.69 (1.485)	38.10 (1.500)	34.93 (1.375)	3.91 (.150)

Notes:

- Dimensions are in millimeters. Inch equivalents are in parentheses (given for general information only).
- R2 dimension may be substituted for mounting screw locations (R1) or front mount cutouts.
- * QPL listing will be provided on request.



Jam nut receptacle*

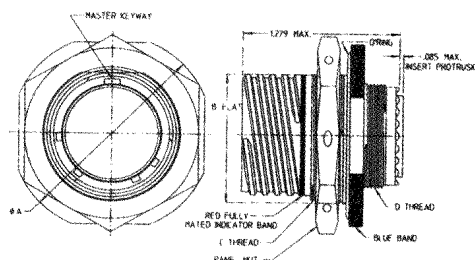

MILITARY PART NUMBERS	DEUTSCH PART NO.	SHELL SIZE	A Ø ±.011	B ±.005	C THREAD	D THREAD
D38999/24*A****	ACT 94*A****	A (9)	1.189	.650	M17X1.0-6g 0.100R	M12X1.0-6g 0.100R
D38999/24*B****	ACT 94*B****	B (11)	1.374	.750	M20X1.0-6g 0.100R	M15X1.0-6g 0.100R
D38999/24*C****	ACT 94*C****	C (13)	1.500	.937	M25X1.0-6g 0.100R	M18X1.0-6g 0.100R
D38999/24*D****	ACT 94*D****	D (15)	1.626	1.061	M28X1.0-6g 0.100R	M22X1.0-6g 0.100R
D38999/24*E****	ACT 94*E****	E (17)	1.752	1.186	M32X1.0-6g 0.100R	M25X1.0-6g 0.100R
D38999/24*F****	ACT 94*F****	F (19)	1.937	1.311	M35X1.0-6g 0.100R	M28X1.0-6g 0.100R
D38999/24*G****	ACT 94*G****	G (21)	2.063	1.436	M38X1.0-6g 0.100R	M31X1.0-6g 0.100R
D38999/24*H****	ACT 94*H****	H (23)	2.189	1.566	M41X1.0-6g 0.100R	M34X1.0-6g 0.100R
D38999/24*J****	ACT 94*J****	J (25)	2.311	1.686	M44X1.0-6g 0.100R	M37X1.0-6g 0.100R

Jam nut mounting

Panel thickness

1.58 - 3.2mm (0.062 - 0.126 in.)

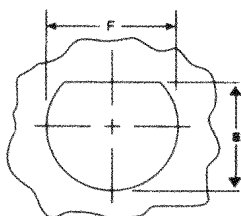

SHELL SIZE	INCH-LBS. TORQUE	E +.00 -.25	F +.25 -.00
A (9)	30/36	17.02 (.670)	17.78 (.700)
B (11)	40/46	18.59 (.771)	20.96 (.825)
C (13)	55/60	24.26 (.955)	25.63 (1.010)
D (15)	70/75	27.56 (1.085)	28.83 (1.135)
E (17)	80/85	30.73 (1.210)	32.01 (1.260)
F (19)	90/95	33.91 (1.335)	35.18 (1.385)
G (21)	100/110	37.08 (1.460)	38.35 (1.510)
H (23)	110/120	40.26 (1.585)	41.53 (1.635)
J (25)	120/130	43.43 (1.710)	44.70 (1.760)

Plug*

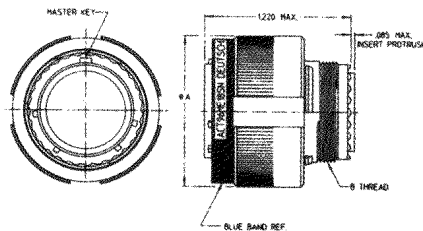

MILITARY PART NUMBERS	DEUTSCH PART NO.	SHELL SIZE	C THREAD	AØ MAX
D38999/26*A****	ACT 96*A****	A (9)	M12X1.0-6g 0.100R .858	.858
D38999/26*B****	ACT 96*B****	B (11)	M15X1.0-6g 0.100R .984	.984
D38999/26*C****	ACT 96*C****	C (13)	M18X1.0-6g 0.100R 1.157	1.157
D38999/26*D****	ACT 96*D****	D (15)	M22X1.0-6g 0.100R 1.279	1.280
D38999/26*E****	ACT 96*E****	E (17)	M25X1.0-6g 0.100R 1.405	1.406
D38999/26*F****	ACT 96*F****	F (19)	M28X1.0-6g 0.100R 1.515	1.516
D38999/26*G****	ACT 96*G****	G (21)	M31X1.0-6g 0.100R 1.641	1.642
D38999/26*H****	ACT 96*H****	H (23)	M34X1.0-6g 0.100R 1.766	1.766
D38999/26*J****	ACT 96*J****	J (25)	M37X1.0-6g 0.100R 1.889	1.890



INSERT ARRANGEMENTS

A-35
6 SIZE 22D CONTACTS



A-98
3 SIZE 20 CONTACTS



B-05
5 SIZE 20 CONTACTS



B-35
13 SIZE 22D CONTACTS



B-98
6 SIZE 20 CONTACTS



B-99
7 SIZE 20 CONTACTS



C-04
4 SIZE 16 CONTACTS

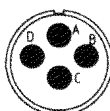

C-08
8 SIZE 20 CONTACTS

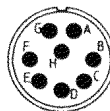

C-35
22 SIZE 22D CONTACTS



C-98
10 SIZE 20 CONTACTS

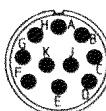

D-05
5 SIZE 16 CONTACTS

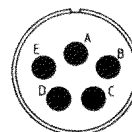

D-18
18 SIZE 20 CONTACTS

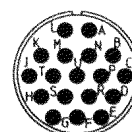

D-19
19 SIZE 20 CONTACTS

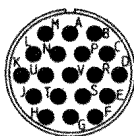

D-23
3 SIZE 16 CONTACTS
2 SIZE 20 CONTACTS
18 SIZE 22 CONTACTS

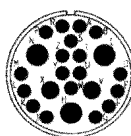

D-35
37 SIZE 22D CONTACTS

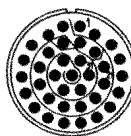

D-97
4 SIZE 16 CONTACTS
8 SIZE 20 CONTACTS

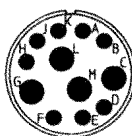

E-06
6 SIZE 12 CONTACTS

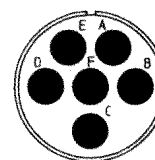

E-08
8 SIZE 16 CONTACTS

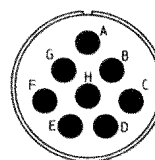

E-19
4 SIZE 16 CONTACTS
11 SIZE 20 CONTACTS
4 SIZE 22 CONTACTS

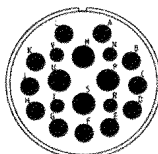

E-26
26 SIZE 20 CONTACTS

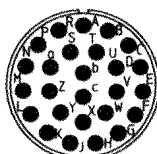

E-35
55 SIZE 22D CONTACTS

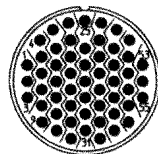

E-99
21 SIZE 20 CONTACTS
2 SIZE 16 CONTACTS

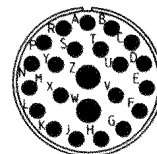

F-11
11 SIZE 16 CONTACTS

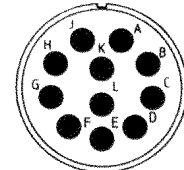

F-32
32 SIZE 20 CONTACTS

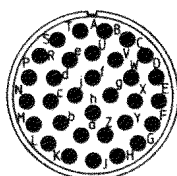

F-35
66 SIZE 22D CONTACTS

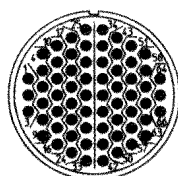

G-11
11 SIZE 12 CONTACTS

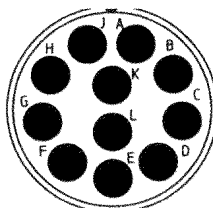

Please consult factory for additional insert arrangements.



G-16
16 SIZE 16 CONTACTS

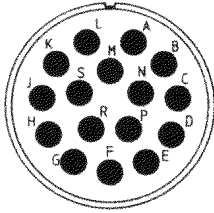

G-35
79 SIZE 22D CONTACTS

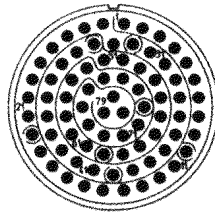

G-39
37 SIZE 20 CONTACTS
2 SIZE 16 CONTACTS

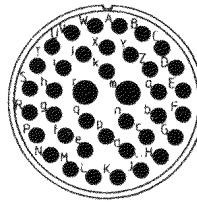

G-41
41 SIZE 20 CONTACTS

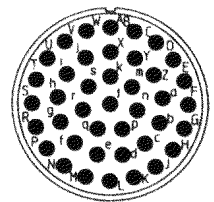

H-21
21 SIZE 16 CONTACTS

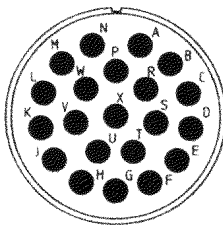

H-35
100 SIZE 22D CONTACTS

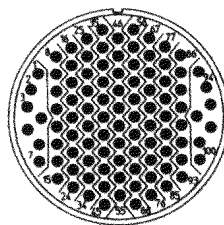

H-53
53 SIZE 20 CONTACTS

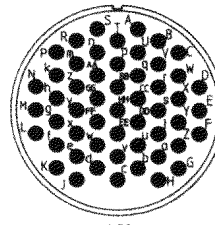

H-55
55 SIZE 20 CONTACTS

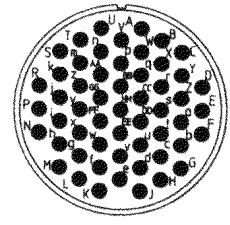

J-04
8 SIZE 16 CONTACTS
48 SIZE 20 CONTACTS

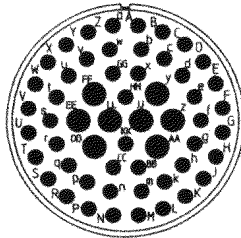

J-19
19 SIZE 12 CONTACTS

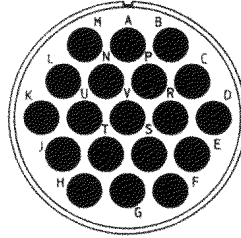

J-20
3 SIZE 8 TWINAX CONTACTS
4 SIZE 12 COAX CONTACTS
13 SIZE 16 CONTACTS
10 SIZE 20 CONTACTS

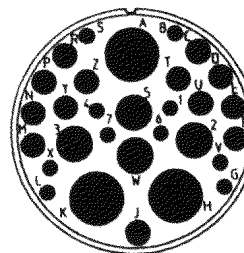

J-24
12 SIZE 12 CONTACTS
12 SIZE 16 CONTACTS

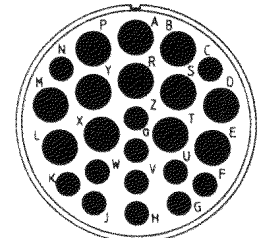

J-29
29 SIZE 16 CONTACTS

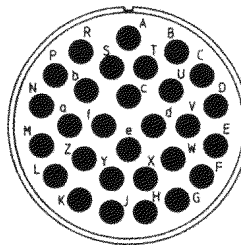

J-35
128 SIZE 22D CONTACTS

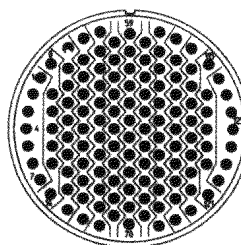

J-43
20 SIZE 16 CONTACTS
23 SIZE 20 CONTACTS

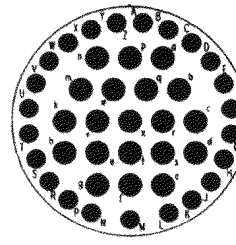

J-61
61 SIZE 20 CONTACTS

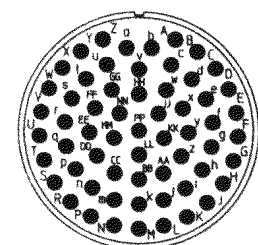

Protective Covers for 38999 III Composite and Metal

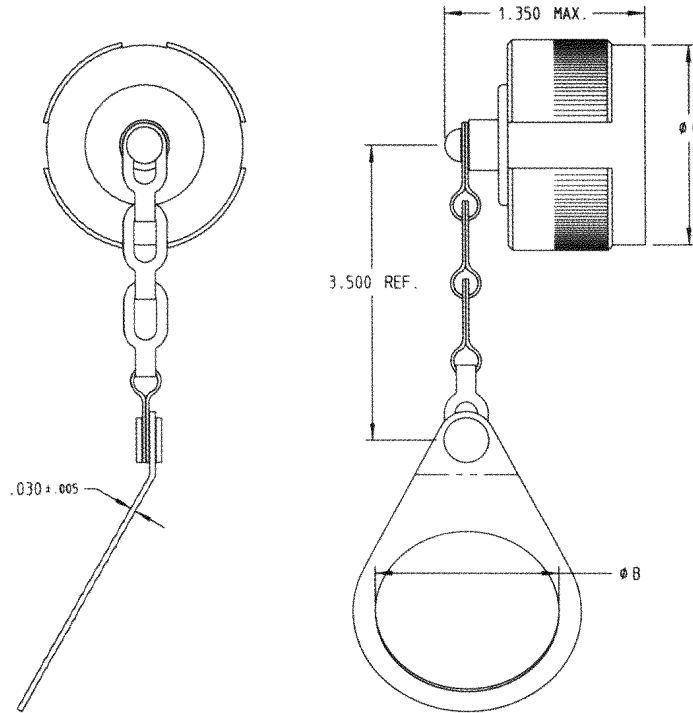

Available in both environmental and environmental RFI/EMI (Shielding).

Part Numbers

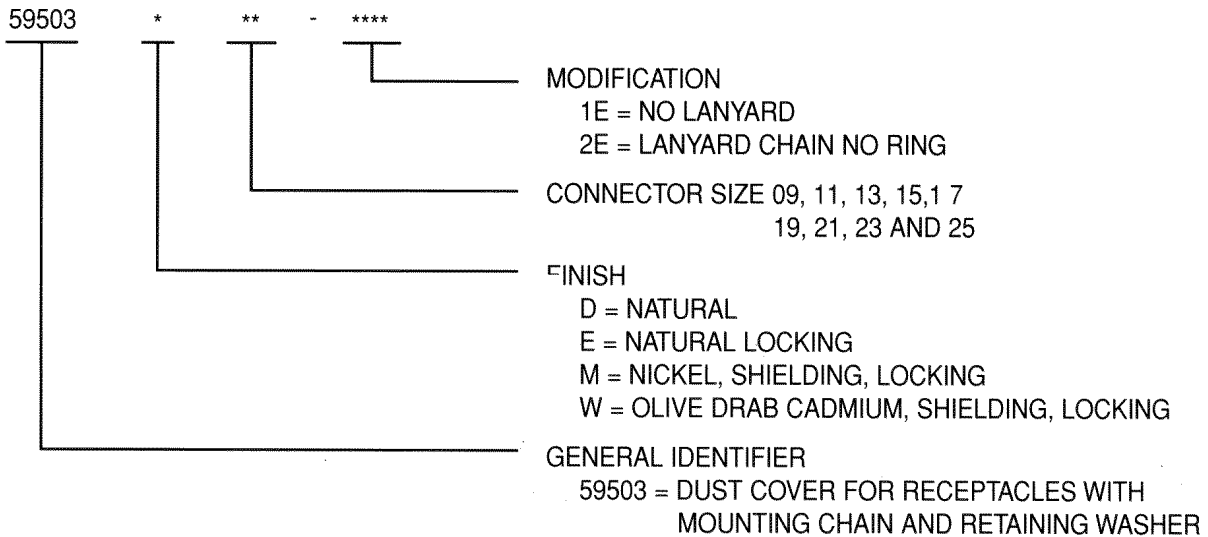

Lightweight Strain Relief, Tie-Type

The ACT provides additional environmental protection by offering a systems approach to rear accessories. The ACT Strain Relief, Tie-Type is made from durable, lightweight, corrosion proof composite materials, and is supplied with a secondary grommet. The secondary grommet provides true strain relief and vibration dampening while providing dynamic moisture intrusion seals.

90 Degree

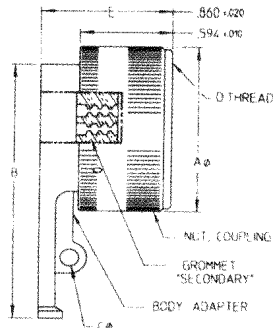

Straight

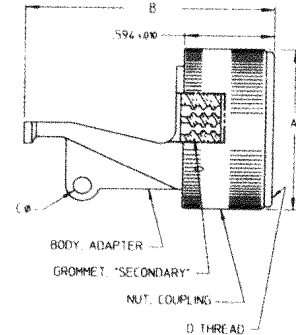

SHELL SIZE	±.015 Aφ	±.080 B	±.010 Cφ	D METRIC THREAD	±.015 E
A	.650	1.948	.140	M12X1.0-6H0.100R	.832
B	.775	2.010	.140	M15X1.0-6H0.100R	.832
C	.905	2.075	.140	M18X1.0-6H0.100R	.832
D	1.030	2.135	.140	M22X1.0-6H0.100R	.832
E	1.160	2.198	.140	M25X1.0-6H0.100R	.832
F	1.270	2.258	.140	M28X1.0-6H0.100R	.832
G	1.400	2.320	.140	M31X1.0-6H0.100R	.832
H	1.525	2.383	.140	M34X1.0-6H0.100R	.832
J	1.655	2.445	.140	M37X1.0-6H0.100R	.832

SHELL SIZE	±.015 Aφ	±.080 B	±.010 Cφ	D METRIC THREAD
A	.650	1.642	.120	M12X1.0-6H0.100R
B	.775	1.642	.120	M18X1.0-6H0.100R
C	.905	1.642	.120	M15X1.0-6H0.100R
D	1.030	1.642	.120	M22X1.0-6H0.100R
E	1.160	1.642	.140	M25X1.0-6H0.100R
F	1.270	1.642	.140	M28X1.0-6H0.100R
G	1.400	1.642	.140	M31X1.0-6H0.100R
H	1.525	1.642	.140	M34X1.0-6H0.100R
J	1.655	1.642	.140	M37X1.0-6H0.100R

Strain Relief Ordering Information

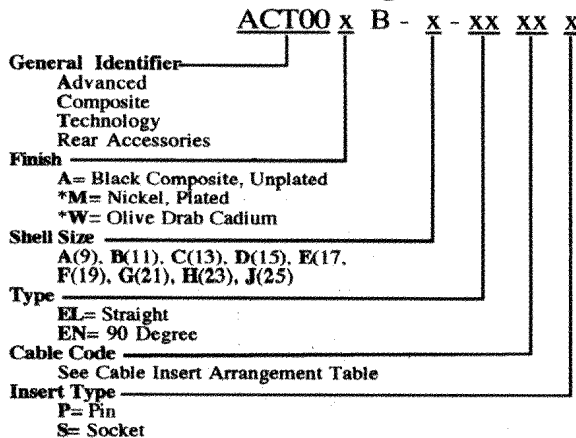

*Consult factory for availability.

Cable Insert Arrangements

CABLE CODE	INSERT ARR.	CABLE CODE	INSERT ARR.	CABLE CODE	INSERT ARR.
38	A-35	53	E-35	88	J-24
39	A-98	54	F-11	69	J-29
40	B-05	55	F-32	70	J-35
41	B-35	56	F-35	71	J-61
42	B-99	57	G-11	92	B-98
43	C-04	58	G-16	93	D-19
44	C-35	59	G-35	94	C-08
45	C-98	60	G-41	95	E-99
46	D-05	61	H-21	96	G-39
47	D-18	62	H-35	97	J-43
48	D-35	63	H-53	98	D-23
49	D-97	64	H-55	99	E-19
50	F-06	65	J-04	100	D-26
51	E-08	66	J-19		
52	E-26	67	J-20		



Ordering information

Deutsch Connector Part Numbers

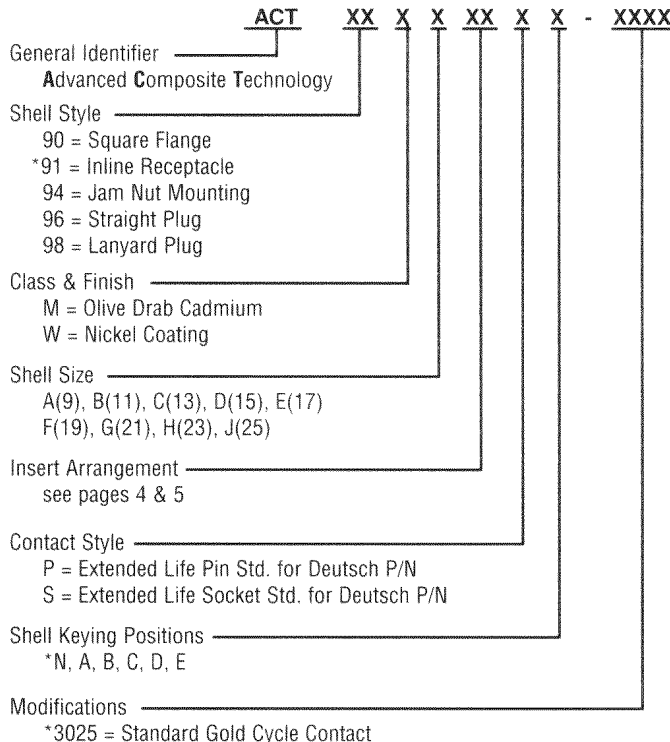

Military Composite Connector Part Numbers

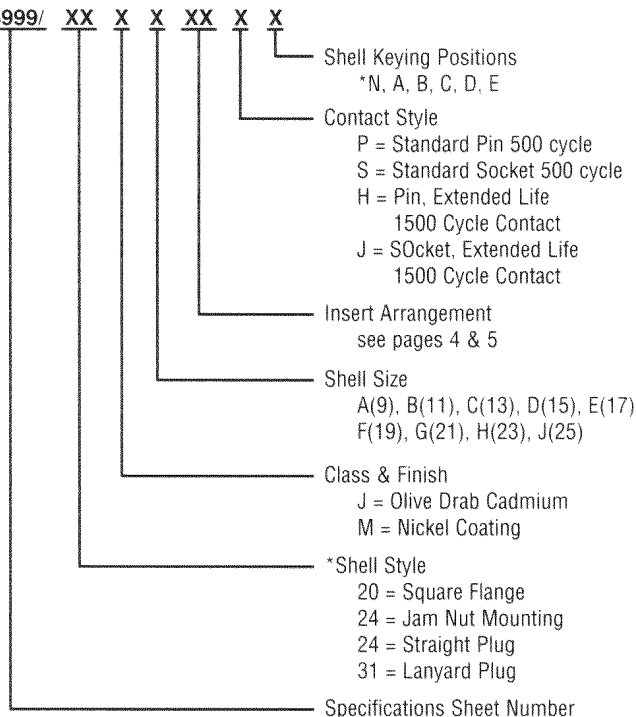

*Consult Factory for availability

Contact & Tooling Information

Contact Deutsch Size	Part Number	Style	Wire Gauge	Crimp Tool (Positioner)	Military Insertion Extraction Tool	Strip Length	Sealing Plugs Deutsch Part Number	Color Code
22D	12331-22 38941-22	PIN	22 THRU 28	M22520/7-01 (M22520/7-07)	M81969/14-01	.160-.190	MS27488-22	GREEN
22D	12333-22 38943-22	SOCKET	22 THRU 28	M22520/7-01 (M22520/7-05)	M81969/14-01	.160-.190	MS27488-22	GREEN
20	12331-20 38941-20	PIN	20 THRU 24	M22520/1-01 (M22520/1-04) RED	M81969/14-10	230-.260	4113-4-2001	RED
20	12333-20 38943-20	SOCKET	20 THRU 24	M22520/1-01 (M22520/1-04) RED	M81969/14-10	230-.260	4113-4-2001	RED
16	12331-16 38941-16	PIN	20 THRU 16	M22520/1-01 (M22520/1-04) BLUE	M81969/14-03	230-.260	0613-1-1601	BLUE
16	12333-16 38943-16	SOCKET	20 THRU 16	M22520/1-01 (M22520/1-04) BLUE	M81969/14-03	230-.260	0613-1-1601	BLUE
12	12331-12 38941-12	PIN	12 THRU 14	M22520/1-01 (M22520/1-04) YELLOW	M81969/14-04	230-.260	0613-1-1201	YELLOW
12	12333-12 38943-12	SOCKET	12 THRU 14	M22520/1-01 (M22520/1-04) YELLOW	M81969/14-04	230-.260	0613-1-1201	YELLOW



This information is for reference only. Consult factory for envelope drawings, updated specifications, and additions to the product line.