

---

# KPTC - NG

---

## INDUSTRIAL CONNECTORS



KCNG-2/899

Cannon

---



**ITT Industries**  
*Engineered for life*

## Introduction

The miniature circular connectors series KPTC -NG (New Generation) from Cannon are especially used in the machine and in the systems industries. The connectors shown in this catalogue fulfill the CE regulations referring to EMC requirements. They extend the well-known KPTC product range. To keep up with the market trends and for logistic reasons Cannon offers nickel for the shell plating.

Connectors KPTC are preferably designed for the usage with crimp contacts. However, also solder contacts are available. The standard order reference number does not include contacts. For automatic processing the contacts are to be ordered separately. All contacts are gold plated.

For fast and reliable attachment of the shielding screen the new universal endbell can be applied. It replaces the usual PG adapters. The shielding screen is fixed by a snap-in mechanism and firmly pressed against the true endbell. Sealing acc to IP67 is achieved by a V-shaped cable seal which equals cold flux of the cable jacket. Cable strain relief is achieved by a cable grip.

### Note:

Endbells described in our catalogue KPTC Connectors should not be used with the KPTC-NG connectors described in this catalogue.

## Contents

Technical Data .....	3
How to order .....	4
Contact Arrangements .....	5
Insulator Positions .....	5
Connectors .....	6
Accessories .....	8
Mounting Dimensions .....	10
Components .....	11
Tooling .....	11
Universal Endbell .....	12
Product Safety .....	13

## Technical Data

Material and Finish	KPTC Standard	KPTC-NG
Shell	Aluminum alloy, nickel plated	Zinc alloy, nickel plated
Insulator	Polychloroprene	Polychloroprene
Grommet and seal	Polychloroprene	ECO
Contacts	Copper alloy, hard gold or hard silver plated	Copper alloy, hard gold or hard silver plated

## Mechanical Data

Shell styles	0 - Wall mounting receptacle	0 - Wall mounting receptacle
	2 - Box mounting receptacle	6 - Straight plug
	6 - straight plug	
	7 - Jam nut receptacle	7 - Jam nut receptacle (under preparation)
Shell sizes	8 - 24	10 - 16 (18 and 20 under preparation)
Polarisation / Coupling	five keyways / 3-point bayonet coupling	
Service classes	E - Grommet seal	IN - Universal endbell optional
	F - Grommet seal with strain relief	

Water tightness

Acc to VG 95319 Part 2, Test Nr. 5.9.2  
 For service classes A to E, J to W, Z1, Z2, Z3 and gaskets style A and B  
 Test pressure 0,2 bar overpressure, Test duration 48 h  
 Test temperature  $25 \pm 0,3^{\circ}\text{C}$   
 The connector shall be free of moisture

## Electrical Data

Number of contacts	6 bis 26			
Wire size	0,4 – 0,75 mm <sup>2</sup> (contact size 20), 1,0 – 2,0 mm <sup>2</sup> (contact size 16)			
Termination type	Crimp technique (Mod. MB), Solder technique (Mod. MA)			
Contact rating	Size	Rated current A	Test current A	Millivolt drop mV
	20	7,5	7,5	below 55
	16	22,0	13,0	below 50
Voltage data	Test voltage	Service class	V <sub>eff</sub>	V=
	at sea level	1	1500	2100
		2	2300	3200
	at 21336 m	1	375	535
		2	550	770
	The operating voltage is to be selected acc to VDE 0110			

### Note

When the connectors in this catalogue are used for voltages greater than 50 Volts and have touchable conductive shell parts they must be used in accordance with the safety regulations DIN VDE Part 410; IEC 60364-4-41. This regulation basically dictates that the power source should be turned off before any mating and unmating of the connector, this regulation does not provide for protection against electrical shock when mating and unmating the connectors in the live condition.

**How to order**

**KPTC 6IN 12 - 14 P - C F42**

**Series** \_\_\_\_\_  
 Cannon designation

**Shell Style** \_\_\_\_\_  
 0IN - Wall Receptacle  
 6IN - Straight Plug

**Shell Size** \_\_\_\_\_  
 10, 12, 14, 16 (18, 20 under preparation)

**Contact Arrangement** \_\_\_\_\_  
 see page 6

**Contact Type** \_\_\_\_\_  
 P - Pin  
 S - Socket

**Alternate Insert Position** \_\_\_\_\_  
 W, X, Y, Z (Normal position not indicated,  
 see page 5)

**Finish** \_\_\_\_\_  
 C - 5 µm nickel

**Modification** \_\_\_\_\_  
 F42 - without endbell

**Optional Modifications**

MA - Connector with solder contact  
 MB - Connector with crimp contact

**Note**

In this catalogue all order reference numbers are listed on page 6 – 9.

Connectors are delivered without contacts. For contacts Optional Modifications.

Contact Arrangements

See page 6

Shell size	Contact number	Contact arrangement	Insulator Positions				
			V	W	X	Y	Z
10	6	10-6	-	90	-	-	-
12	3	12-3	-	-	-	180	-
14	10	12-10	-	60	155	270	295
	5	14-5	-	40	92	184	273
	12	14-12	-	43	90	-	-
	15	14-15	-	17	110	155	234
16	19	14-19	-	30	165	315	.
	8	16-8	-	54	152	180	331
	23	16-23	-	158	270	-	-
	26	16-26	-	60	-	275	338

Insulator Positions

The diagram shows alternate insert positions. Six positions N, V, W, X, Y and Z differ in the degree of rotation for the various connector sizes and contact arrangements.

The table indicates the exact degree of rotation for each contact arrangement.

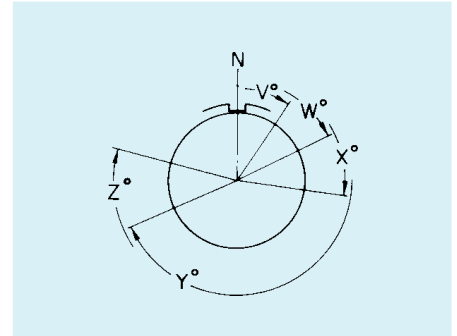

Contact arrangement

Contact number

Order reference  
Crimp contacts

Order reference  
Free connectors with shielded  
universal endbell  
(delivered without contacts)

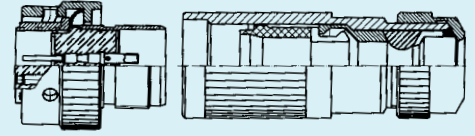

10-6P  
10-6S



6 X # 20  
6 X #20

430-8560-404  
031-8704-508

KPTC6IN10-6P-C  
KPTC6IN10-6S-C

12-3P  
12-3S



3 x # 16  
3 x # 16

430-8560-406  
031-8704-502

KPTC6IN12-3P-C  
KPTC6IN12-3S-C

12-10P  
12-10S



10 x # 20  
10 x # 20

430-8560-404  
031-8704-508

KPTC6IN12-10P-C  
KPTC6IN12-10S-C

12-14P  
12-14S



14 X # 20  
14 x # 20

430-8560-404  
031-8704-508

KPTC6IN12-14P-C  
KPTC6IN12-14S-C

14-5P  
14-5S

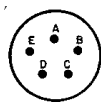

5 x # 16  
5 x # 16

430-8560-406  
031-8704-502

KPTC6IN14-5P-C  
KPTC6IN14-5S-C

14-12P  
14-12S



8 x # 20  
4 x # 16  
8 x # 20  
4 x # 16

430-8560-404  
430-8560-406  
031-8704-508  
031-8704-502

KPTC6IN14-12P-C  
KPTC6IN14-12S-C

14-15P  
14-15S

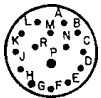

14 x # 20  
1 x # 16  
14 x # 20  
1 x # 16

430-8560-404  
430-8560-406  
031-8704-508  
031-8704-502

KPTC6IN14-15P-C  
KPTC6IN14-15S-C

14-19P  
14-19S

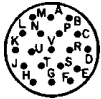

19 x # 20  
19 x # 20

430-8560-404  
031-8704-508

KPTC6IN14-19P-C  
KPTC6IN14-19S-C

16-8P  
16-8S

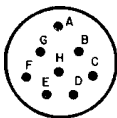

8 x # 16  
8 x # 16

430-8560-406  
031-8704-502

KPTC6IN16-8P-C  
KPTC6IN16-8S-C

16-23P  
16-23S

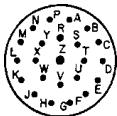

22 x # 20  
1 x # 16

430-8560-404  
031-8704-508

KPTC6IN16-23P-C  
KPTC6IN16-23S-C

16-26P  
16-26S

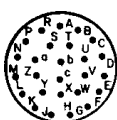

26 x # 20  
26 x # 20

430-8560-404  
031-8704-508

KPTC6IN16-26P-C  
KPTC6IN14-26S-C

Order reference  
Free connectors without  
endbell  
(delivered without contacts)

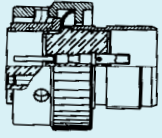

KPTC6IN10-6P-C-F42  
KPTC6IN10-6S-C-F42

Order reference  
Fixed connector with shielded  
universal endbell  
(delivered without contacts)

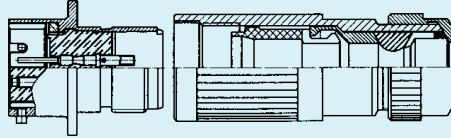

KPTC0IN10-6P-C  
KPTC0IN10-6S-C

Order reference  
Connectors without endbell  
(delivered without contacts)

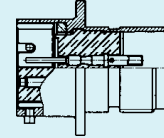

KPTC0IN10-6P-C-F42  
KPTC0IN10-6S-C-F42

KPTC6IN12-3P-C-F42  
KPTC6IN12-3S-C-F42

KPTC0IN12-3P-C  
KPTC0IN12-3S-C

KPTC0IN12-3P-C-F42  
KPTC0IN12-3S-C-F42

KPTC6IN12-10P-C-F42  
KPTC6IN12-10S-C-F42

KPTC0IN12-10P-C  
KPTC0IN12-10S-C

KPTC0IN12-10P-C-F42  
KPTC0IN12-10S-C-F42

KPTC6IN12-14P-C-F42  
KPTC6IN12-14S-C-F42

KPTC0IN12-14P-C  
KPTC0IN12-14S-C

KPTC0IN12-14P-C-F42  
KPTC0IN12-14S-C-F42

KPTC6IN14-5P-C-F42  
KPTC6IN14-5S-C-F42

KPTC0IN14-5P-C  
KPTC0IN14-5S-C

KPTC0IN14-5P-C-F42  
KPTC0IN14-5S-C-F42

KPTC6IN14-12P-C-F42  
KPTC6IN14-12S-C-F42

KPTC0IN14-12P-C  
KPTC0IN14-12S-C

KPTC0IN14-12P-C-F42  
KPTC0IN14-12S-C-F42

KPTC6IN14-15P-C-F42  
KPTC6IN14-15S-C-F42

KPTC0IN14-15P-C  
KPTC0IN14-15S-C

KPTC0IN14-15P-C-F42  
KPTC0IN14-15S-C-F42

KPTC6IN14-19P-C-F42  
KPTC6IN14-19S-C-F42

KPTC0IN14-19P-C  
KPTC0IN14-19S-C

KPTC0IN14-19P-C-F42  
KPTC0IN14-19S-C-F42

KPTC6IN16-8P-C-F42  
KPTC6IN16-8S-C-F42

KPTC0IN16-8P-C  
KPTC0IN16-8S-C

KPTC0IN16-8P-C-F42  
KPTC0IN16-8S-C-F42

KPTC6IN16-23P-C-F42  
KPTC6IN16-23S-C-F42

KPTC0IN16-23P-C  
KPTC0IN16-23S-C

KPTC0IN16-23P-C-F42  
KPTC0IN16-23S-C-F42

KPTC6IN16-26P-C-F42  
KPTC6IN16-26S-C-F42

KPTC0IN16-26P-C  
KPTC0IN16-26S-C

KPTC0IN16-26P-C-F42  
KPTC0IN16-26S-C-F42

Shell size /  
Contact arrangement

optional:  
Universal endbell,  
shielded,  
for plug / receptacle with Mod. -F42

optional:  
Plastic endbell  
with strain relief and IP67 sealing  
for plug / receptacle with Mod. -F42

optional:  
Plastic endbell  
with strain relief, without sealing  
for plug / receptacle with Mod. -F42

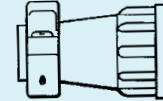
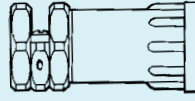

10-6P  
10-6S



192993-0081  
192993-0081

192900-0636  
192900-0636

192900-0639  
192900-0639

12-3P  
12-3S



192993-0082  
192993-0082

192900-0636  
192900-0637

192900-0640  
192900-0640

12-10P  
12-10S



192993-0082  
192993-0082

192900-0637  
192900-0637

192900-0640  
192900-0640

12-14P  
12-14S



192993-0082  
192993-0082

192900-0637  
192900-0637

192900-0640  
192900-0640

14-5P  
14-5S

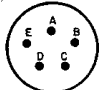

192993-0083  
192993-0083

192900-0496  
192900-0496

192900-0286  
192900-0286

14-12P  
14-12S



192993-0083  
192993-0083  
192993-0083

192900-0496  
192900-0496  
192900-0496

192900-0286  
192900-0286  
192900-0286

14-15S



192993-0083

192900-0496

192900-0286

14-19P  
14-19S



192993-0083  
192993-0083

192900-0496  
192900-0496

192900-0286  
192900-0286

16-8P  
16-8S

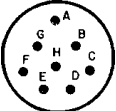

192993-0084  
192993-0084

192900-0497  
192900-0497

192900-0343  
192900-0343

16-23P  
16-23S



192993-0084  
192993-0084

192900-0497  
192900-0497

192900-0343  
192900-0343

16-26P  
16-26S

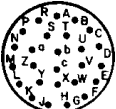

192993-0084  
192993-0084

192900-0497  
192900-0497

192900-0343  
192900-0343



# KPTC-NG

optional:  
Plastic protection cap  
for plug / receptacle

optional:  
Metal protection cap  
for plug

optional:  
Metal protection cap  
for receptacle

Flange gasket

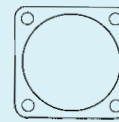
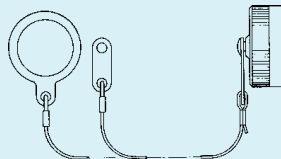
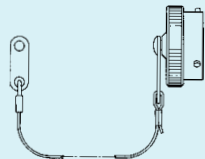
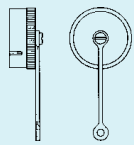

-

KPTC80-10N-C  
KPTC80-10N-C

KPTC81-10N-C  
KPTC81-10N-C

075-8543-011  
075-8543-011

-

KPTC80-12N-C  
KPTC80-12N-C

KPTC81-12N-C  
KPTC81-12N-C

075-8543-012  
075-8543-012

-

KPTC80-12N-C  
KPTC80-12N-C

KPTC81-12N-C  
KPTC81-12N-C

075-8543-012  
075-8543-012

-

KPTC80-12N-C  
KPTC80-12N-C

KPTC81-12N-C  
KPTC81-14N-C

075-8543-012  
075-8543-012

-

KPTC80-14N-C  
KPTC80-14N-C

KPTC81-14N-C  
KPTC81-14N-C

075-8543-013  
075-8543-013

-  
-  
-

KPTC80-14N-C  
KPTC80-14N-C  
KPTC80-14N-C

KPTC81-14N-C  
KPTC81-14N-C  
KPTC81-14N-C

075-8543-013  
075-8543-013  
075-8543-013

-

KPTC80-14N-C

KPTC81-14N-C

075-8543-013

-  
-

KPTC80-14N-C  
KPTC80-14N-C

KPTC81-14N-C  
KPTC81-14N-C

075-8543-013  
075-8543-013

-  
192900-0388

KPTC80-16N-C  
KPTC80-16N-C

KPTC81-16N-C  
KPTC81-16N-C

075-8543-014  
075-8543-014

192900-0388  
192900-0388

KPTC80-16N-C  
KPTC80-16N-C

KPTC81-16N-C  
KPTC81-16N-C

075-8543-014  
075-8543-014

192900-0388  
192900-0388

KPTC80-16N-C  
KPTC80-16N-C

KPTC81-16N-C  
KPTC81-16N-C

075-8543-014  
075-8543-014

## Mounting Dimensions

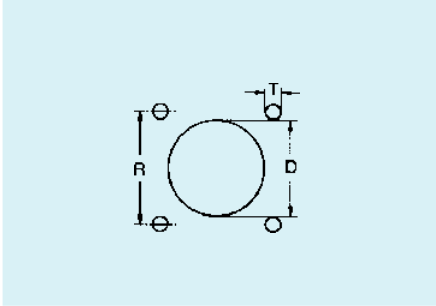

## Receptacle for Flange Mounting

Shell size	Rear mounting	Front mounting		
	D +0,25	D +0,25	R ±0,15	T +0,3
10	18,7	17,8	18,3	3,1
12	22,4	21,0	20,6	3,1
14	25,5	24,1	23,0	3,1
16	28,3	27,3	24,6	3,1

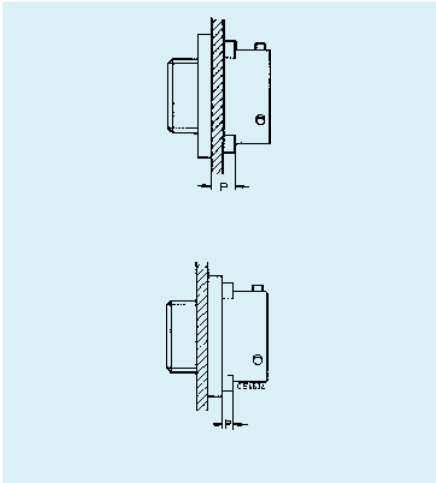

## Mounting Hole Diameter

Shell size	P max. (for rear mounting incl. panel thickness)
10	2,20
12	2,20
14	2,20
16	2,20

## Flange Gaskets

Shell size	Alu-Flex conductive	Chloroprene non-conductive
	10	075-8543-001
12	075-8543-002	075-8543-012
14	075-8543-003	075-8543-013
16	075-8543-004	075-8543-014

## Contacts

Contact size	Order reference number
	Hard gold plated
20 Socket	031-8704-508
20 Pin	430-8560-404
16 Socket	031-8704-502
16 Pin	430-8560-406

## Wire sizes

Contact size 20	Wire size metric:	0,4-0,75 mm <sup>2</sup>
	Sealing area (Insulation Ø)	1,4-2,15 mm
Contact size 16	Wire size metric:	1,0-2,0 mm <sup>2</sup>
	Sealing area (Insulation Ø)	1,6-2,7 mm

## Wire Hole Filler

Contact size	Colour code	Order reference number
20	Rot	225-1012-000
16	Blau	225-1011-000

## Tooling

### Contact Crimp Tools

Hand tool	Locator for contact size 20, 16	Test gage for hand crimp tool
M22520/1-01	M22520/1-02	M22520-/3-1

Semi-automatic crimp station  
HACS-KPTC

Pneumatic bench tool  
612141 with locator M22520/1-02

### Contact Insertion Tools

Contact size	Tool	Spare tip
20	CITG-20A	CITG-20A-Tip
16	CIT-16	CIT-16-Tip
Contact size	Tool (pair of pliers)	
20	CIT-KPTC-20	
16	CIT-F80-16	

### Contact Extraction Tools

Contact size	Tool	Spare tipe
20	CET-KPTC-20	CET-KPTC-20-Tip
16	CET-KPTC-16	CET-KPTC-16-Tip

### Mounting adapter

Please ask for our detailed KPTC Assembly Instruction!

Universal Endbell

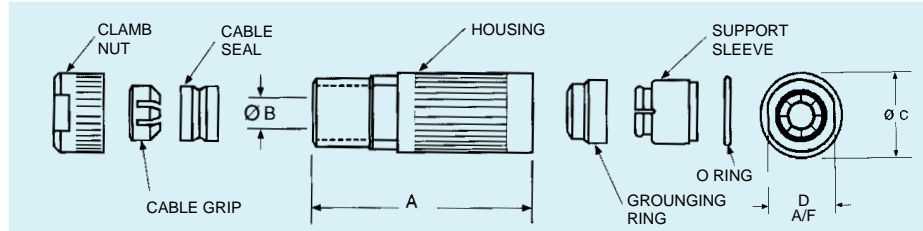

Shell Size	Part Number	A	B	C	D
10	192993-0081	56,60	8,00	17,90	13,00
12	192993-0082	56,70	10,00	21,00	16,00
14	192993-0083	57,00	11,30	24,00	19,00
16	192993-0084	57,40	13,60	27,40	22,00

Cables

The TNM Shielded Endbell covers a wide range of multicore cables used in industrial applications. The table below indicates the sizes that can be accommodated provided the sheath outside diameter is within the accommodation range shown.

Endbell Size	Cable Accomodation.Outer Sheath Diameter	
	Minimum	Maximum
10	4,40	7,30
12	6,40	9,50
14	6,90	10,20
16	7,90	12,60

Attenuation

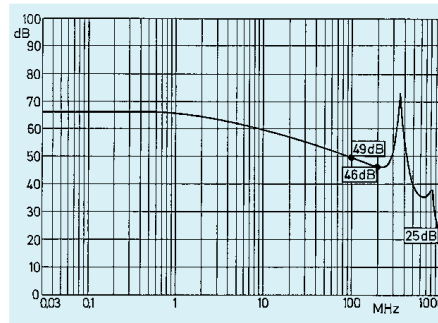

## Product Safety Information

**THIS NOTE SHOULD BE READ IN CONJUNCTION WITH THE PRODUCT DATA SHEET/CATALOGUE. FAILURE TO OBSERVE THE ADVICE IN THIS INFORMATION SHEET AND THE OPERATING CONDITIONS SPECIFIED IN THE PRODUCT DATA SHEET/CATALOGUE COULD RESULT IN HAZARDOUS SITUATIONS.**

### 1. MATERIAL CONTENT AND PHYSICAL FORM

Electrical connectors do not usually contain hazardous materials. They contain conducting and non-conducting materials and can be divided into two groups.

- a) Printed circuit types and low cost audio types which employ all plastic insulators and casings.
- b) Rugged, Fire Barrier and High Reliability types with metal casings and either natural rubber, synthetic rubber, plastic or glass insulating materials.

Contact materials vary with type of connector and also application and are usually manufactured from either copper, copper alloys, nickel, alumel, chromel or steel. In special applications, other alloys may be specified.

### 2. FIRE CHARACTERISTICS AND ELECTRIC SHOCK HAZARD

**There is no fire hazard when the connector is correctly wired and used within the specified parameters. Incorrect wiring or assembly of the connector or careless use of metal tools or conductive fluids, or transit damage to any of the component parts may cause electric shock or burns. Live circuits must not be broken by separating mated connectors as this may cause arcing, ionisation and burning.**

Heat dissipation is greater at maximum resistance in a circuit. Hot spots may occur when resistance is raised locally by damage, e.g. cracked or deformed contacts, broken strands of wire. Local overheating may also result from the use of the incorrect application tools or from poor quality soldering or slack screw terminals. Overheating may occur if the ratings in the Product Data Sheet/Catalogue are exceeded and can cause breakdown of insulation and hence electric shock.

If heating is allowed to continue it intensifies by further increasing the local resistance through loss of temper of spring contacts, formation of oxide film on contacts and wires, and leakage currents through carbonisation of insulation and tracking paths. Fire can then result in the presence of combustible materials and this may release noxious fumes. Overheating may not be visually apparent. Burns may result from touching overheated components.

### 3. HANDLING

Care must be taken to avoid damage to any component parts of electrical connectors during installation and use. Although there are normally no sharp edges, care must be taken when handling certain components to avoid injury to fingers.

Electrical connectors may be damaged in transit to the customers, and damage may result in creation of hazards. Products should therefore be examined prior to installation/use and rejected if found to be damaged.

### 4. DISPOSAL

Incineration of certain materials may release noxious or even toxic fumes.

### 5. APPLICATION

Connectors with exposed contacts should not be selected for use on the current supply side of an electrical circuit, because an electric shock could result from touching exposed contacts on an unmated connector. Voltages in excess of 30 V ac or 42.5 V dc are potentially hazardous and care should be taken to ensure that such voltages can not be transmitted in any way to exposed metal parts of the connector body. The connector and wiring should be checked, before making live, to have no damage to metal parts or insulators, no solder blobs, loose strands, conducting lubricants, swarf, or any other undesired conducting particles. Insulation resistance should be checked to make certain that no low resistance joints or spurious conducting path are existing between contacts and exposed metal parts of the connector body. Further the contact resistance of the connectors should be measured within the electrical circuit in order to identify high resistances which result in excessive connector heating.

Always use the correct application tools as specified in the Data Sheet/Catalogue.

Do not permit untrained personnel to wire, assemble or tramper with connectors.

For operation voltage please see appropriate national regulations.

### IMPORTANT GENERAL INFORMATION.

1. Air and creepage paths/Operating voltage  
The admissible operating voltages depend on the individual applications and the valid national and other applicable safety regulations.

For this reason the air and creepage path data are only reference values. Observe reduction of air and creepage paths due to PC board and/or harnessing.

2. Temperature

All information given are temperature limits. The operation temperature depends on the individual application.

3. Other important information

Cannon continuously endeavours to improve their products. Therefore, Cannon products may deviate from the description, technical data and shape as shown in this catalogue and data sheets.

4. Harnessing and Assembly Instructions

If applicable, our special harnessing and/or assembly instruction has to be adhered to. This is provided at request.

ITT Cannon manufactures the highest quality products available in the marketplace; however these products are intended to be used in accordance with the specifications in this catalog. Any use or application that deviates from stated operating specifications is not recommended and may be unsafe. No information and data contained in this catalog shall be construed to create any liability on the part of Cannon. Any new issue of this catalog shall automatically invalidate and supersede any and all previous issues. **A limited warranty applies to Cannon products. Except for obligations assumed by Cannon under this warranty, Cannon shall not be liable for any loss, damage, cost of repairs, incidental or consequential damages of any kind, whether or not based on express or implied warranty, contract, negligence or strict liability arising in connection with the design, manufacture, sale, use or repair of the products.** Product availability, prices and delivery dates are exclusively subject to our respective order confirmation form; the same applies to orders based on development samples delivered. This catalog is not be construed as an offer. It is intended merely as an invitation to make an offer. By this publication, Cannon does not assume responsibility or any liability for any patent infringements or other rights of third parties which may result from its use. Reprinting this catalog is generally permitted, indicating the source. However, Cannon's prior consent must be obtained in all cases.

Cannon is a trademark of ITT Industries, Inc