

Tous droits strictement réservés. Reproduction ou communication e des tiers interdite sans autorisation écrite par FCJ ELECTRONICS INC. Propriété de c FCJ ELECTRONICS INC.

All rights strictly reserved. Reproduction or issue to third parties in any form whatever is not permitted without written authority from the proprietor. Property of c FCJ ELECTRONICS INC. Copyright FCJ ELECTRONICS INC.



All rights strictly reserved. Reproduction or issue to third parties in any form whatever is not permitted without written authority from the proprietor. Property of c FCJ ELECTRONICS INC. Copyright FCJ ELECTRONICS INC.

PRODUCT NO.
10028886-XXX__
NOTE: ④

NOTE:
1. MATERIAL
HOUSING: HIGH TEMPERATURE THERMOPLASTIC, UL 94V-0 RATED, BLACK.
CONTACT: POWER PIN- HIGH CONDUCTIVITY COPPER ALLOY
SIGNAL PIN- COPPER ALLOY
2. PRODUCT SPECIFICATION: GS-12-259.
3. PACKAGE SPECIFICATION: GS-14-937.
4. PLATING SPEC:
-10028886-XXX BOTH AREA ALL OVER 50u" NICKEL UNDERPLATED.
POWER PIN- 30u" GOLD ON MATING AREA;
SIGNAL PIN= 15u" GOLD ON MATING AREA;
BOTH SOLDER TAILS- 100u" MATTE TIN/LEAD.
-10028886-XXXLF BOTH AREA ALL OVER 50u" NICKEL UNDERPLATED.
POWER PIN- 30u" GOLD ON MATING AREA;
SIGNAL PIN= 15u" GOLD ON MATING AREA;
BOTH SOLDER TAILS- 100u" MATTE PURE Sn.
6. P/N 10028886-XXXLF MEETS EUROPEAN UNION DIRECTIVE
AND OTHER COUNTRY REGULATIONS AS DESCRIBED IN GS-22-008.

7. THE HOUSING WILL WITHSTAND EXPOSURE TO 260°C PEAK TEMPERATURE FOR 10 SECONDS IN A WAVE SOLDER APPLICATION WITH A CIRCUIT BOARD.
8. MANUFACTURER'S NAME, P/N AND DATE CODE TO APPEAR ON THIS SURFACE AS PER GS-24-007.

www.fciconnect.com			surface	tolerance std	projection	MM
			TOLERANCES UNLESS OTHERWISE SPECIFIED		A3	Scale NONE
Dr	LH	2004-11-15	ANGULAR	0.X ± 0.25		
Eng	JULIA WANG	2009-01-14	LINEAR	0.XX ± 0.15	size	ECN
Chr	GARY Hsieh	2009-01-14	0th 2"	0.XXX ± 0.10	ECN	Spec ref
Appr	DAVID SU	2009-01-14	Product family Power Edge Card		Spec ref	
FCJ			title POWER EDGE CARD CONNECTOR		Rev. L	
			ASS'Y		10028886	
			catalog no		CUSTOMER COPY sheet 1 of 5	

REV F - 2006-06-17

Tous droits strictement réservés. Reproduction ou communication à des tiers interdite sous quelque forme que ce soit sans autorisation écrite du propriétaire. Propriété de c FCI ELECTRONICS. Droits de reproduction FCI ELECTRONICS INC.



All rights strictly reserved. Reproduction or issue to third parties in any form whatever is not permitted without written authority from the proprietor. Property of c FCI ELECTRONICS. Copyright FCI ELECTRONICS INC.

PRODUCT NO.
10028886-XXX__
NOTE: ④

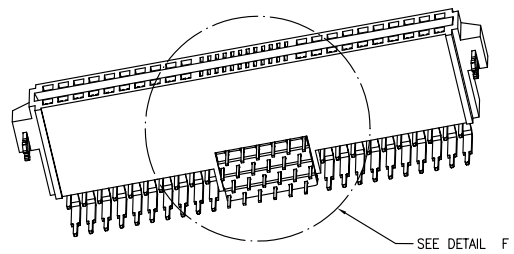
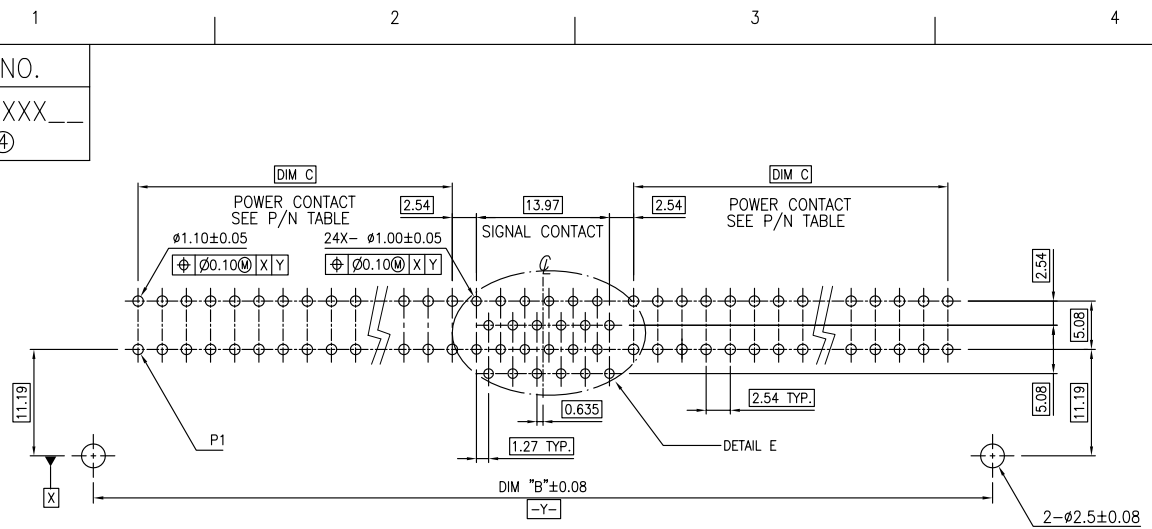

www.fciconnect.com		surface <input checked="" type="checkbox"/>	tolerance std	projection	MM
		TOLERANCES UNLESS OTHERWISE SPECIFIED			
Dr	LH	2004-11-15	ANGULAR	0.X ± 0.25	size A3
Eng	JULIA WANG	2009-01-14	LINEAR	0.XXX ± 0.15	Scale NONE
Chr	GARY HSIEH	2009-01-14	0° 2°	0.XXXX ± 0.10	ECN
Appr	DAVID SU	2009-01-14	Product family Power Edge Card	Spec ref	
		title POWER EDGE CARD CONNECTOR ASS'Y		chg no 10028886	Rev. L
		catalog no		CUSTOMER COPY	sheet 2 of 5

REV F - 2008-04-17

Tous droits strictement réservés. Reproduction ou communication, a des tiers interdite sous quelque forme que ce soit sans autorisation écrite du propriétaire. Propriété de © FCI ELECTRONICS INC.

All rights strictly reserved. Reproduction or issue to third parties in any form whatever is not permitted without written authority from the proprietor. Property of © FCI ELECTRONICS INC.

PRODUCT NO.
10028886-XXX__
NOTE: ④

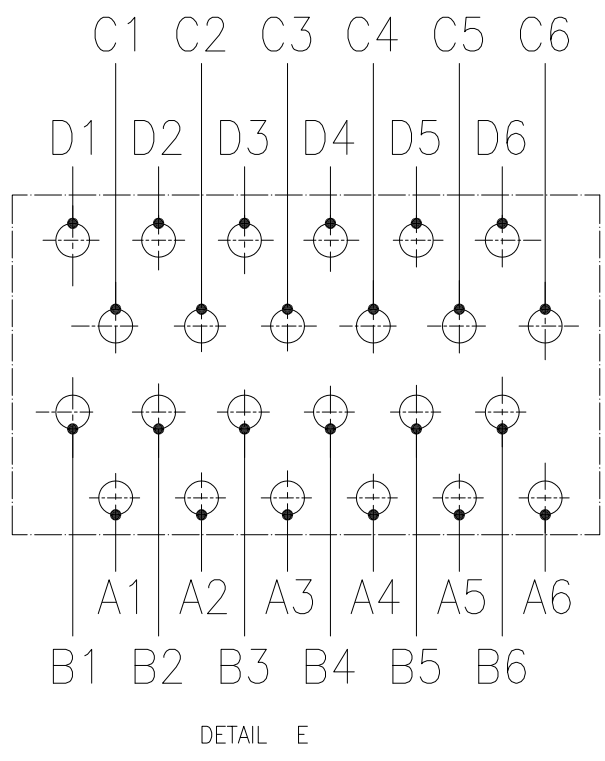

DETAIL E

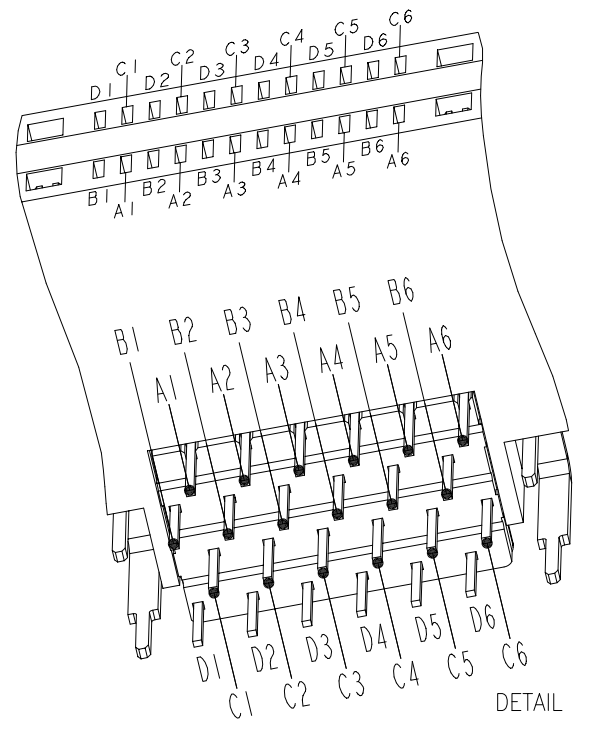

DETAIL F

www.fciconnect.com		surface <input checked="" type="checkbox"/>	tolerance std	projection	MM
		TOLERANCES UNLESS OTHERWISE SPECIFIED			
Dr	LH	2004-11-15	ANGULAR	0.X ± 0.25	size A3
Eng	JULIA WANG	2009-01-14	LINEAR	0.XX ± 0.15	Scale NONE
Chr	GARY HSIEH	2009-01-14	±0° 2°	0.XXX ± 0.10	ECN
Appr	DAVID SU	2009-01-14	Product family Power Edge Card		Spec ref
		title POWER EDGE CARD CONNECTOR ASS'Y		dng 10028886 Rev. L	
catalog no		CUSTOMER COPY		sheet 3 of 5	
		cage code 22526			

PDM: Rev:L STATUS Released Printed: Jan 26, 2011

All rights strictly reserved. Reproduction or issue to third parties in any form
 however is not permitted without written authority from the proprietor.
 Property of FCI ELECTRONICS Copyright FCI ELECTRONICS INC.



Tous droits strictement réservés. Reproduction ou communication à des tiers interdite
 sous quelque forme que ce soit sans autorisation écrite du propriétaire.
 Propriété de FCI ELECTRONICS. Droits de reproduction FCI ELECTRONICS INC.

PRODUCT NO.
 10028886-XXX__
 NOTE: ④

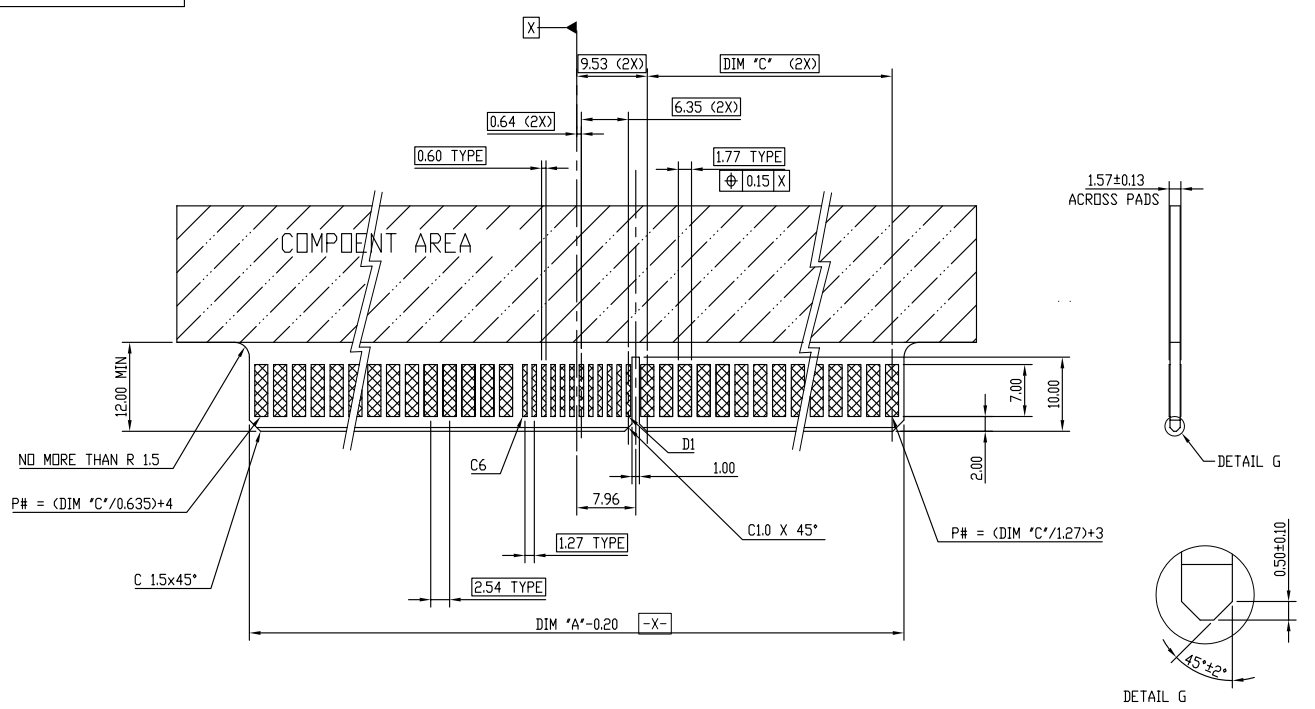

RECOMMENDED MODULE BOARD LAYOUT



www.fciconnect.com			surface	tolerance std	projection	MM
			✓	TOLERANCES UNLESS OTHERWISE SPECIFIED	⊕	←
Dr	LH	2004-11-15	ANGULAR	0.X ± 0.25	size	Scale
Eng	JULIA WANG	2009-01-14	LINEAR	0.XX ± 0.15	A3	NONE
Chr	GARY HSIEH	2009-01-14	± 0° 2°	0.XXX ± 0.10	ECN	
Appr	DAVID SU	2009-01-14	Product Family	Power Edge Card	Spec ref	
FCI			title	POWER EDGE CARD CONNECTOR	dwg no	Rev.
			ASS'Y		10028886	L
			catalog no		CUSTOMER COPY	sheet 4 of 5

REV F - 026-04-07

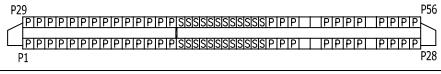
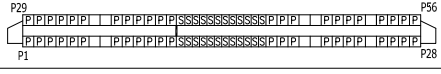
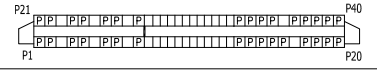
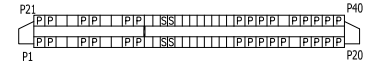
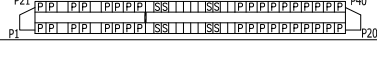
All rights strictly reserved. Reproduction or issue to third parties in any form
 whatever is not permitted without written authority from the proprietor.
 Property of © FCI ELECTRONICS INC. Copyright FCI ELECTRONICS INC.

PART NO.	DIM "A"	DIM "B"	DIM "C"	DIM "D"	HOUSING CAVITY CONF. (PAIR)	CONTACT CONFIGURATION(SEE NOTE)
10028886-001	42.80	48.77	10.16	13.46	5P + 12S + 5P	ALL LOADED
10028886-001LF						
10028886-002	52.96	58.93	15.24	18.54	7P + 12S + 7P	ALL LOADED
10028886-002LF						
10028886-003	88.52	94.49	33.02	36.32	14P + 12S + 14P	ALL LOADED
10028886-003LF						
10028886-003A	88.52	94.49	33.02	36.32	14P + 12S + 14P	
10028886-003ALF						
10028886-003B	88.52	94.49	33.02	36.32	14P + 12S + 14P	
10028886-003BLF						
10028886-103	88.52	94.49	33.02	36.32	14P + 12S + 14P	ALL LOADED
10028886-103LF						
10028886-004	68.20	74.17	22.86	26.16	10P + 12S + 10P	ALL LOADED
10028886-004LF						
10028886-004A	68.20	74.17	22.86	26.16	10P + 12S + 10P	
10028886-004ALF						
10028886-004B	68.20	74.17	22.86	26.16	10P + 12S + 10P	
10028886-004BLF						
10028886-004CLF	68.20	74.17	22.86	26.16	10P + 12S + 10P	

NOTE:
 1."P" FOR POWER PIN;
 "S" FOR SIGNAL PIN;
 "□" FOR NOT LOADED

www.fciconnect.com		surface <input checked="" type="checkbox"/>	tolerance std	projection 	MM
TOLERANCES UNLESS OTHERWISE SPECIFIED		ANGULAR	LINEAR	size A3	Scale NONE
Dr LH	2004-11-15	0.X ±	0.25		
Eng JULIA WANG	2009-01-14	0.XX ±	0.15		
Chr GARY HSIEH	2009-01-14	0.XXX ±	0.10	ECN	
Appr DAVID SU	2009-01-14	Product family Power Edge Card		Spec ref	
	title POWER EDGE CARD CONNECTOR ASS'Y	chg 02	10028886	Rev. L	
catalog no	CUSTOMER COPY		code 22526	sheet 5 of 5	