

THIS COPY IS PROVIDED ON A RESTRICTED BASIS AND IS NOT TO BE USED IN ANY WAY DETRIMENTAL TO THE INTERESTS OF PANDUIT CORP.

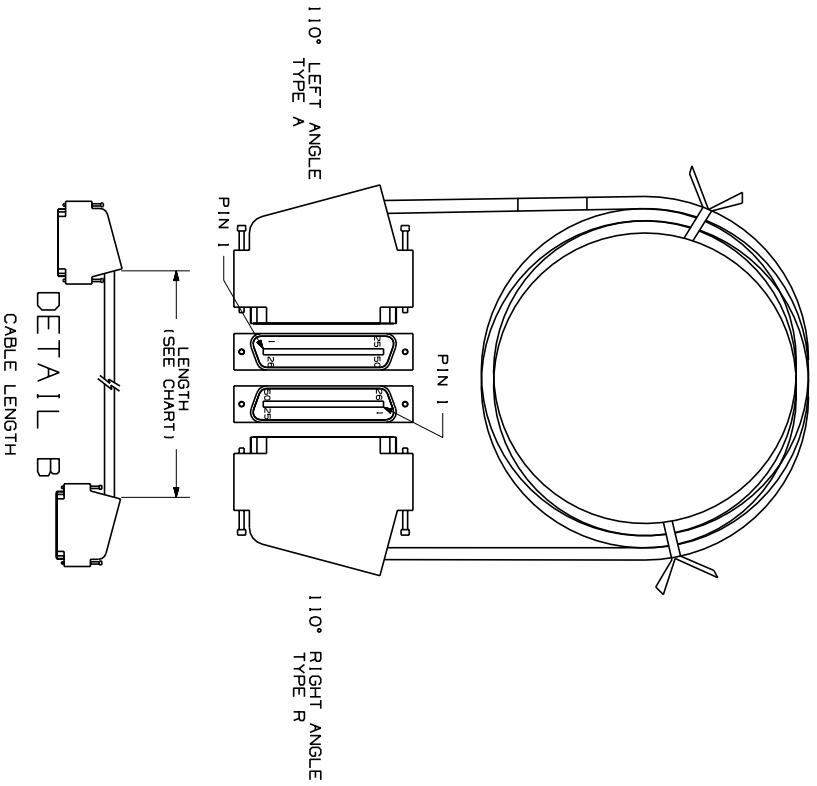

PART NUMBER	LENGTH	WEIGHT
UTPCHLR25Y	6" (152.4)/7-2" (50.8)	1.20 LB/EACH (545 G/EACH)
UTPCHLR25Y	8" (2438.4)	1.44 LB/EACH (654 G/EACH)
UTPCHLR25Y	10" (3048)	2.05 LB/EACH (932 G/EACH)
UTPCHLR25Y	15" (4572)	2.66 LB/EACH (1209 G/EACH)
UTPCHLR25Y	20" (6096)	3.27 LB/EACH (1485 G/EACH)
UTPCHLR25Y	6" (1829)	1.20 LB/EACH (545 G/EACH)

- NOTES:
1. SEE CURRENT CATALOG TO INDICATE PACKAGE QUANTITY.
  2. SEE CATALOG FOR COMPLETE LIST OF PARTS APPLICABLE FOR USE WITH THIS PART.
  3. MATES WITH FEMALE RJ21 CONNECTOR AND 10/100 BASE T PATCH PANEL.
  4. CATEGORY 5 AND POWER SUM RATED.
  5. DIMENSIONS IN PARENTHESES ARE IN METRIC.

CAD FILENAME/LAYERS  
M02479KL\_DC273\_00A.PRT

**PANDUIT**  
CORP., TINLEY PARK, ILLINOIS

25 PAIR PATCH CORD ASSEMBLY  
ONE 110° LEFT RJ21 MALE CONNECTOR AND  
ONE 110° RIGHT RJ21 MALE CONNECTOR  
(UTPCHIXLR25Y) CUSTOMER DRAWING

UNLESS OTHERWISE SPECIFIED,  
DIMENSIONAL TOLERANCES ARE:  
(.XX) ±.010(.3)  
(.XXX) ±.010(.3)  
(.XXX) ±.031(.8) ANGLES ±

UNLESS OTHERWISE SPECIFIED,  
ALL DIMENSIONS ARE GIVEN  
IN INCHES, THIRD ANGLE PROJECTION.

REV	DATE	BY	CHK	DESCRIPTION	ECN	CHK	CUST	SUP	DRAWN BY	DATE	CHECKED BY	MAT'L:	SCALE	DRAWING NO.	DWG SIZE
R	3-20-06	NER		RELEASED TO PRODUCTION.	02479-273				NER	3-20-06		CONNECTOR HSG: UL94 V-0 THERMOPLASTIC CABLE JACKET: PVC	NONE	02479-273	A