

**tyco**

*Electronics*

**Card Edge Connectors**  
Catalog 1654080 Issued 7-03

**AMP**

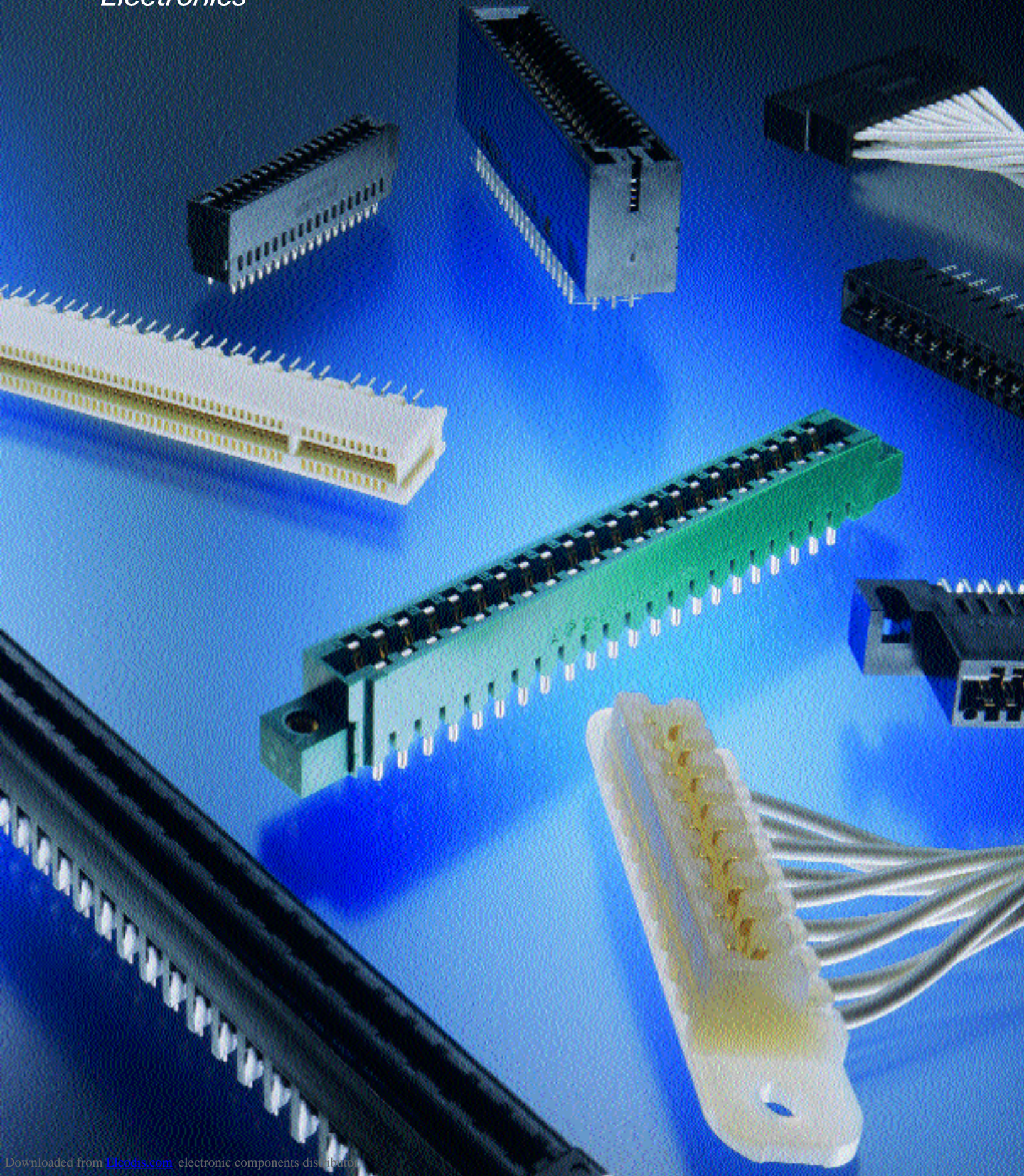



**Introduction**

This catalog contains product descriptions of AMP Card Edge Connectors. These connectors are presented in three groups: Solder Type Board-to-Board, Press-fit Board-to-Board, and Wire-to-Board connectors.

To assist you in the selection of the appropriate connector for your application, a selection guide is provided at the beginning of each section. See the Table of Contents on the following page for the exact location.

A comprehensive description and features of a partic-

ular printed circuit board connector family are provided at the beginning of that section. Various technical documents are referenced in the connector family sections and are listed and described at the rear of this catalog.

The Tyco Electronics products presented in this catalog are designed and manufactured according to the highest possible standards of quality and craftsmanship. They offer optimum reliability at the lowest possible cost.

**Need more information?**

Call Technical Support at the numbers listed at the bottom of the catalog pages.

Technical Support is staffed with specialists well versed in Tyco Electronics products. They can provide you with:

- Technical Support
- Catalogs
- Technical Documents
- Product Samples
- Tyco Electronics Authorized Distributor Locations

**Dimensioning:**

Dimensions are in inches and millimeters unless specified otherwise. Values in brackets are metric equivalents.

Metric symbols used are:

- m (meter)
- mm (millimeter)
- mm<sup>2</sup> (square millimeter)
- kg (kilogram)
- C (Celsius)
- N (newton)

**Note:** Dimensions in this catalog are for reference purposes only. Customer drawings are available upon request.

© Copyright 1992, 1996 and 2002 by Tyco Electronics. All Rights Reserved.

AMP, ACTION PIN, AMP-DURAGOLD, AMP-LEAF, AMP-O-LECTRIC, AMP-O-MATIC, AMPOMATOR, AMP PACE, CERTI-CRIMP, DUO-TYNE, ECONOMATE, TELEDENSITY, and TYCO are trademarks.

Other products, logos, and company names mentioned herein may be trademarks of their respective owners.

**Produced under a Quality Management System certified to ISO 9001**

A copy of the certificate is available upon request



**Table of Contents**

**Solder Type Board-to-Board Connectors**

Introduction .....2  
 Selection Guide .....4-6

**Standard Edge Series Connectors**

Standard Edge .050 PCI Card Edge Connectors .....7-10  
 Standard Edge .050 Series Connectors .....11-14  
 Standard Edge II Connectors .....15-27

**Cantilever Beam Dip Solder Tails Overview**

.....28  
 .100" [2.54] Centerline .....29-34  
 .125" [3.18] Centerline .....35-37  
 .156" [3.96] Centerline .....38-40

**Modified Bellows Contact Overview**

.....41  
 .100" [2.54] Centerline .....42-47  
 .125" [3.18] Centerline .....48-52  
 .156" [3.96] Centerline .....53-56

**Polarization Keys**

.....57

**Standard Daughter Card Layout**

.....57

**Low Profile Connectors**

.....58-63

**Twin Leaf Mother Board Connectors**

.....64-72

**Rotary Cam ZIF Connectors**

.....73-82

**Linear ZIF Connectors**

.....83-96

**Press-Fit Board-to-Board Connectors**

ACTION PIN Press-Fit Contacts .....97  
 AMP PACE Connectors .....98-115  
 TELEDENSITY Connectors .....116-118  
 ECONOMATE Connectors .....119-126

**Cantilever Beam Press-Fit Connectors Overview**

.....127  
 .050" [1.27] High Density .....128-129  
 .100" [2.54] Centerline .....130-140  
 .125" [3.18] Centerline .....141-144  
 .156" [3.96] Centerline .....145-148  
 Application Tooling .....149-151

**Wire-to-Board Connectors**

Introduction .....152  
 Selection Guide .....153  
 Crimp Snap Twin Leaf Connectors .....154-163  
 AMP-LEAF Connectors .....164-172  
 High Current Connectors .....173-176  
 DUO-TYNE Flag Connectors .....177-180  
 Printed Circuit Board Connector Hood Assemblies .....181-183  
 Application Tooling .....184,185

**Technical Documents**

.....186,187

**Part Number Index**

.....188-201

**Tyco Electronics Related Product Information**

.....202

**Selection Guide, Board-to-Board Connectors**

Selection Guide

**Introduction**

Board-to-board (mother/daughter board) connectors are ideally suited to back-plane wiring or any other application requiring the circuit connection of one printed circuit board to another. Designed to shorten manufacturing time and reduce applied costs, these one-step, pre-assembled connectors are ready for mounting and mass insertion.

Many of the connectors are available with the proven and reliable ACTION PIN contact. This unique contact has superior electrical and physical characteristics that are top of the line in the industry.

Board-to-board connectors come in a range of contact centerline spacings of .050 [1.27] to .156 [3.96]. A wide range of dual position sizes and post styles are available. One family of connectors features zero insertion force of the daughter board, along with a choice of actuating devices. A variety of housing and contact materials further expands the choice of connectors available to meet many application requirements.

To help in choosing a connector for your application, a Selection Guide is provided on pages 4 through 6.

**Standard Edge .050 Series PCI Connectors (Pages 7-10)**

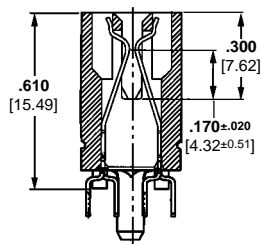

**Standard Edge .050 Series Connectors (Pages 11-14)**

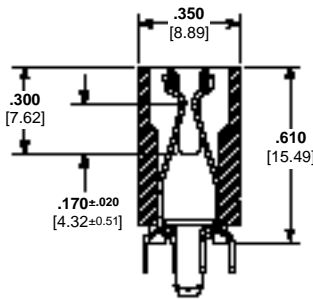

**Standard Edge II Connectors (.100 and .125 Centerline) (Pages 15-27)**

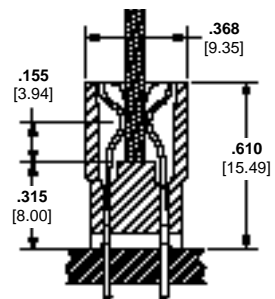

**Centerlines**

.050 [1.27]	X	X	
.100 [2.54]			X
.125 [3.18]			X
.150 [3.81]			
.156 [3.96]			

**Tail Styles**

Solder	X	X	X
Right-Angle Solder			X
Wrap-Type			X
Card Extender			X
Solder Eyelet			
Press-Fit			
Surface-Mount			

**Selection Guide, Board-to-Board Connectors** (Continued)

**Standard Edge II Connectors (.150 Centerline)**  
(Pages 15-27)

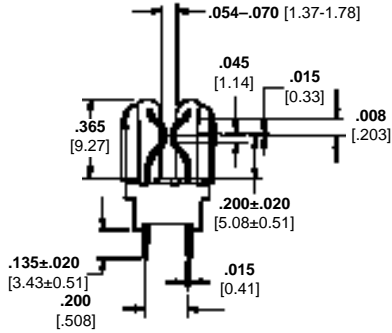

**Cantilever Beam Connectors Standard Housing**  
(Pages 28-40)

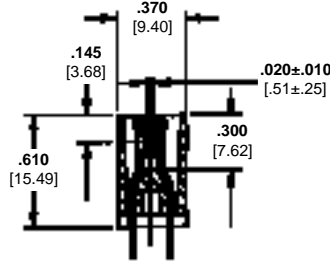

**Cantilever Beam Connectors Scoop Housing**  
(Pages 28-40)

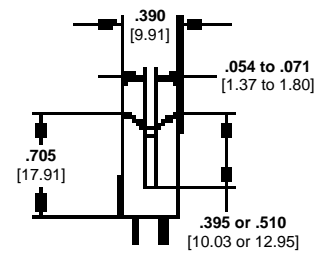

**Centerlines**

			.050 [1.27]
			.0625 [1.588]
	X	X	.100 [2.54]
	X	X	.125 [3.18]
X			.150 [3.81]
	X	X	.156 [3.96]

**Tail Styles**

		X	Solder
			Right-Angle Solder
			Wrap-Type
			Card Extender
			Solder Eyelet
	X	X	Press-Fit
			Surface-Mount

**Modified Bellows Connector**  
(Pages 41-56)

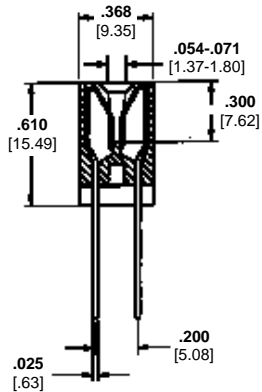

**Low Profile Connectors**  
(Pages 58-63)

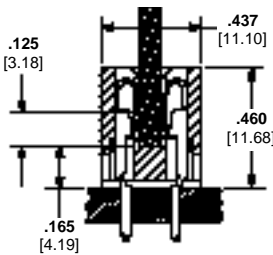

**Twin Leaf Mother Board Connectors**  
(Pages 64-72)

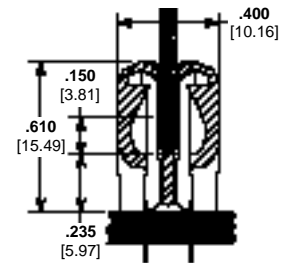

**Centerlines**

			.050 [1.27]
	X	X	.100 [2.54]
	X	X	.125 [3.18]
		X	.150 [3.81]
X		X	.156 [3.96]

**Tail Styles**

		X	Solder
			Right-Angle Solder
			Wrap-Type
			Card Extender
			Solder Eyelet
	X		Press-Fit
			Surface-Mount

**Rotary Cam ZIF Connectors (Pages 73-82)**

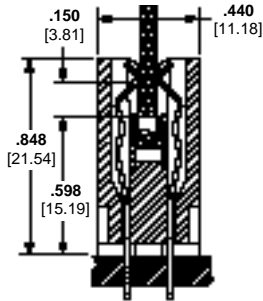

**Linear ZIF Connectors (Pages 83-96)**

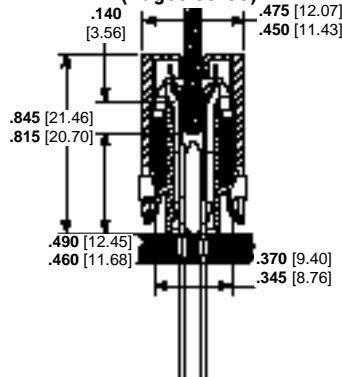

**AMP PACE Connectors, Card Scoop Housing (Pages 98-115)**

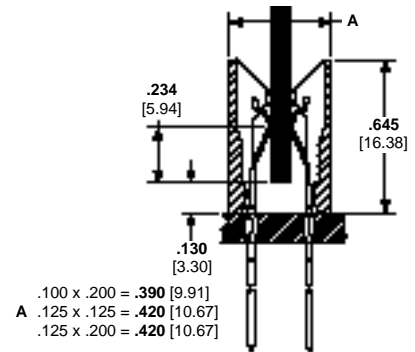

**Centerlines**

.050 [1.27]			
.0625 [1.588]			
.100 [2.54]	X		X
.125 [3.18]	X	X	X
.150 [3.81]			
.156 [3.96]	X		

**Tail Styles**

Solder	X	X	
Right-Angle Solder	X		
Wrap-Type	X	X	X
Card Extender			
Solder Eyelet			
Press-Fit		X	X
Surface-Mount			

**AMP PACE Connectors, Standard Housing (Pages 98-115)**

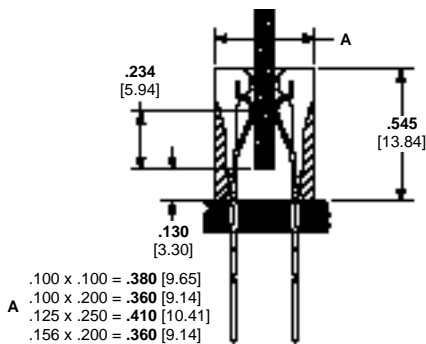

**ECONOMATE Connectors (Pages 119-126)**

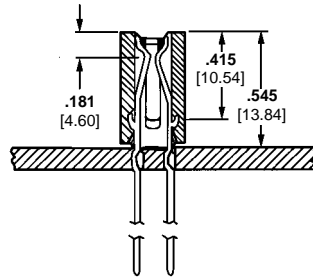

**High Density Press Fit Connector For .093 Cards (Pages 128-129)**

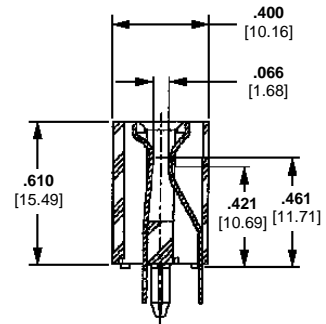

**Centerlines**

.050 [1.27]			
.0625 [1.588]			
.100 [2.54]	X	X	
.125 [3.18]	X		
.150 [3.81]			
.156 [3.96]	X	X	

**Tail Styles**

Solder			
Right-Angle Solder			
Wrap-Type	X		
Card Extender			
Solder Eyelet			
Press-Fit	X	X	X
Surface-Mount			

**Standard Edge .050 Series PCI Card Edge Connectors**

**Product Facts**

- High density .050 [1.27] centerline contact spacing
- Easy mating of high circuit count daughter boards
- Polarizing web for positive board-to-connector registration
- Choice of plastic pylons or metal holddowns

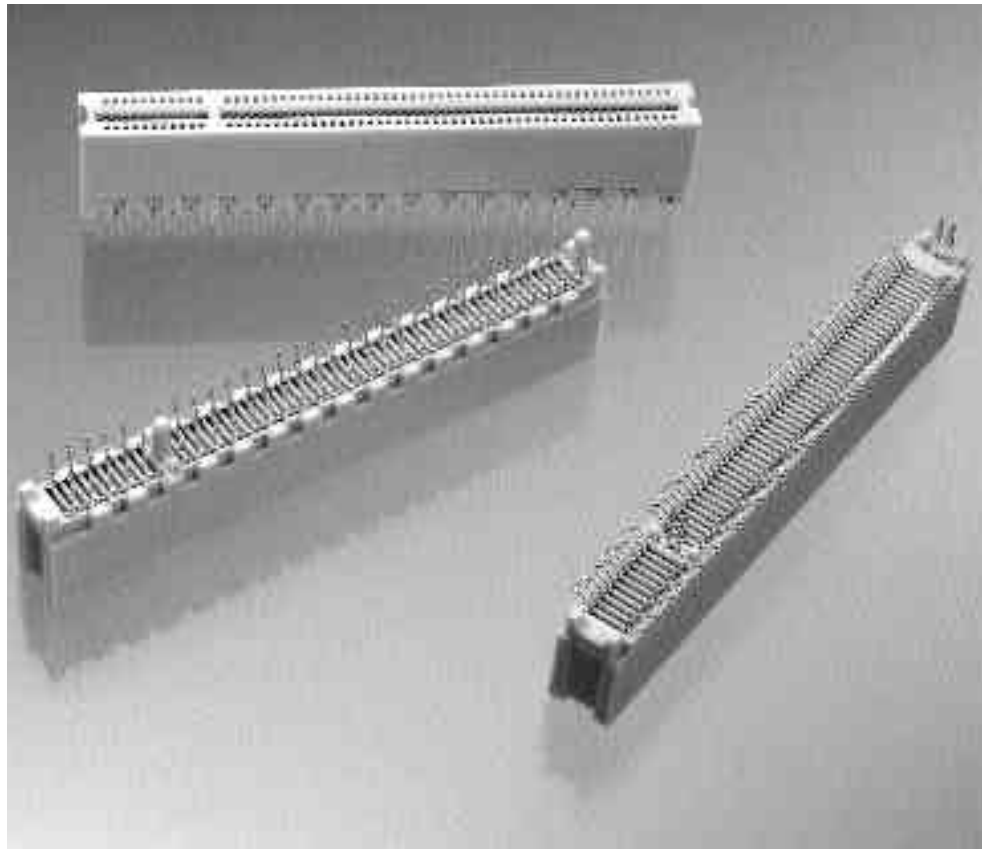

Connectors that support PCI expansion cards are derived from those on the MicroChannel Architecture (MCA) bus. The MCA connectors are well defined and have proven value and reliability.

There are four connectors that can be used depending upon the PCI implementation. The differences between these connectors are 32 bit and 64 bit, and the 5 volt and 3.3 volt signaling environments. PCI-X is a version of PCI at 133 MHz which is under development and employs standard PCI connectors. PCI-X is limited to 1 slot versus 4 slots of PCI.

A key differentiates the signaling environment voltages. The same physical connector is used for the 32 bit signaling environments. In one orientation, the key accepts 5 volt boards. When rotated 180°, the connector accepts 3.3 volt signaling boards. The pin numbering of the connector changes for the different signaling environments to maintain the same relative position of signals on the connector.

**Performance Specifications:**

- Durability**—Tested to 100 mating cycles
- Mating Force**—8 oz [2.22 N] max. per contact pair
- Unmating Force**—.5 oz [0.14 N] min. per contact pair
- Contact Resistance**—20 milliohms max. (initial) 30 milliohms max. (final)
- Insulation Resistance**—1000 megohms min.
- Dielectric Withstanding Voltage**—500 VAC (at sea level)
- Capacitance**—2 picofarads max.
- Current Rating**—1 ampere max.
- Voltage Rating**—203 VAC
- Thermal Shock**—-55°C to +85°C for 5 cycles
- Mixed Flowing Gas**—Class II with mated board for 20 days

**Technical Documents:**

- Product Specification**  
108-14034
- Application Specification**  
114-26012
- Qualification Test Report**  
501-203

**Standard Edge .050 Series PCI Card Edge Connectors**

**64 Bit, 5 Volt Signaling**

**92 Dual Positions with 3 Plastic Pylons or 3 Metal Holddowns**

**Material and Finish:**

**Housing**—High temperature thermo-plastic 94V-0 rated, white

**Contacts**—Phosphor bronze, plated as follows:

**Plating B**—Duplex plated .000015 [0.00038] min. gold in contact area, .000100 [0.00254] min. tin-lead on solder tails, with entire contact underplated .000050 [0.00127] min. nickel

**Plating C**—Duplex plated .000030 [0.00076] min. gold in contact area, .000100 [0.00254] min. tin-lead on solder tails, with entire contact underplated .000050 [0.00127] min. nickel

**Plastic Pylons**

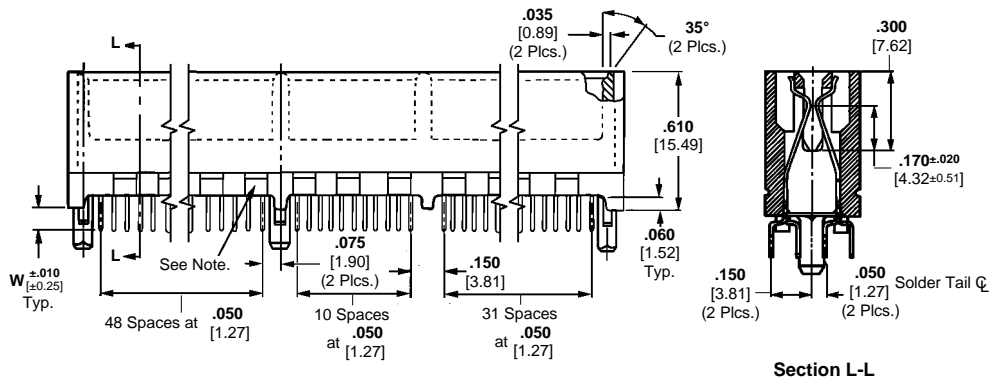
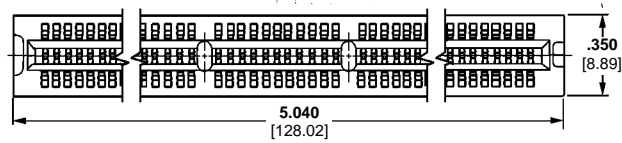

Section L-L

**Related Product Data:**

**Performance Specifications**—page 7

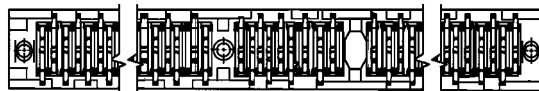

**Technical Documents:**

**Product Specification**  
108-14034

**Application Specification**  
114-26012

**Metal Holddowns**

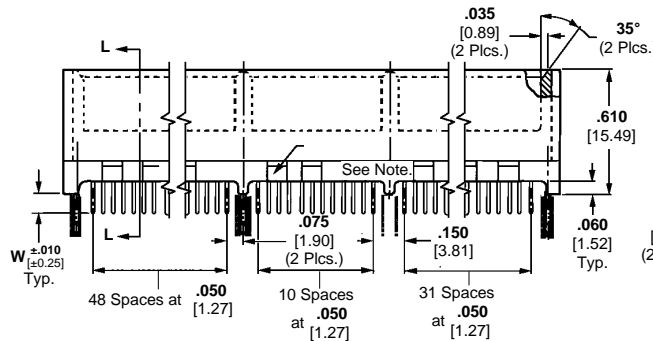

**Through Hole**

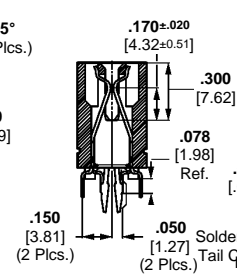

**Surface Mount**

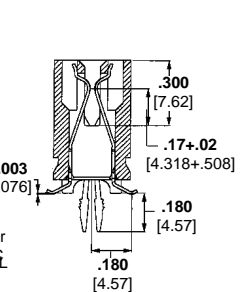

Section L-L

W (Post Length)	Contact Finish	Part Numbers	
		3 Plastic Pylons	3 Metal Holddowns
.100 2.54	Plating B	145166-2	—
	Plating C	145166-4	145169-4
.125 3.18	Plating C	145166-8	145169-8
Surface Mount	Plating C	—	145113-1

**Notes:** 1. Connectors are supplied with either cored (shown above) or solid side walls.  
2. Other connector sizes can be made available, consult Tyco Electronics.



**Standard Edge .050 Series PCI Card Edge Connectors**

**32 Bit, 3.3 and 5 Volt Signaling**

**60 Dual Positions with 2 Plastic Pylons or 2 Metal Holddowns**

**Material and Finish:**

**Housing Y**—High temperature thermo-plastic 94V-0 rated, white

**Housing Z**—Nylon 6/6, white

**Contacts**—Phosphor bronze, plated as follows:

**Plating A**—Duplex plated gold flash in contact area, .000100 [0.00254] min. tin-lead on solder tails, with entire contact underplated .000050 [0.00127] min. nickel

**Plating B**—Duplex plated .000015 [0.00038] min. gold in contact area, .000100 [0.00254] min. tin-lead on solder tails, with entire contact underplated .000050 [0.00127] min. nickel

**Plating C**—Duplex plated .000030 [0.00076] min. gold in contact area, .000100 [0.00254] min. tin-lead on solder tails, with entire contact underplated .000050 [0.00127] min. nickel

**Plastic Pylons**

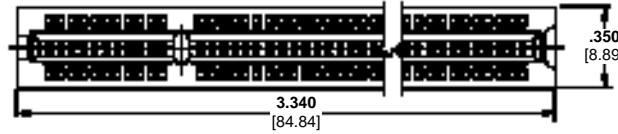

**Related Product Data:**

**Performance Specifications**—page 7

**Technical Documents:**

**Product Specification**  
108-14034

**Application Specification**  
114-26012

**Metal Holddowns**

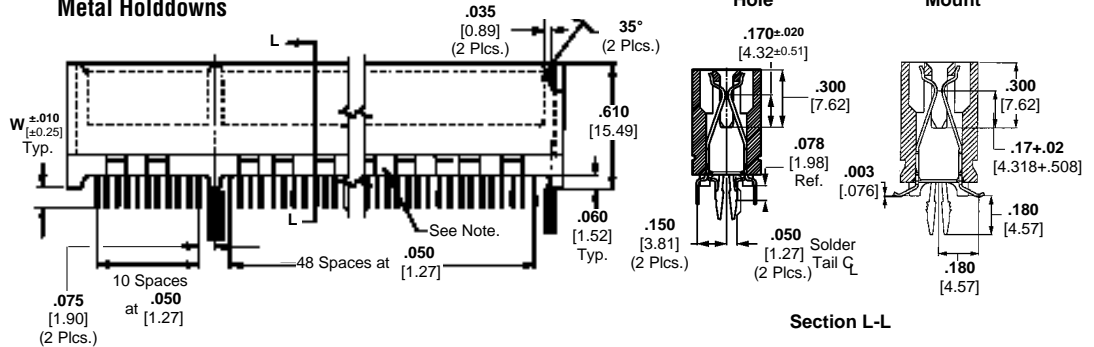

W (Post Length)	Housing Material	Contact Finish	Part Numbers	
			2 Plastic Pylons	2 Metal Holddowns
.100 2.54	Y	Plating A	145154-1	145167-1
		Plating B	145154-2	—
		Plating C	145154-4	145167-4
.118 3.00	Z	Plating A	11299-1	—
		Plating B	11299-6	—
.125 3.18	Y	Plating C	145154-8	—
Surface Mount	Y	Plating C	—	145098-1

**Notes:** 1. Connectors are supplied with either cored (shown above) or solid side walls.  
2. Other connector sizes can be made available, consult Tyco Electronics.

Solder Type Board-to-Board Connectors

**Standard Edge .050 Series PCI Card Edge Connectors**

64 Bit, 3.3 Volt Signaling

92 Dual Positions  
with 3 Plastic Pylons or  
3 Metal Holddowns

**Material and Finish:**

**Housing**—High temperature thermo-plastic 94V-0 rated, white

**Contacts**—Phosphor bronze, plated as follows:

**Plating B**—Duplex plated .000015 [0.00038] min. gold in contact area, .000100 [0.00254] min. tin-lead on solder tails, with entire contact underplated .000050 [0.00127] min. nickel

**Plating C**—Duplex plated .000030 [0.00076] min. gold in contact area, .000100 [0.00254] min. tin-lead on solder tails, with entire contact underplated .000050 [0.00127] min. nickel

**Plastic Pylons**

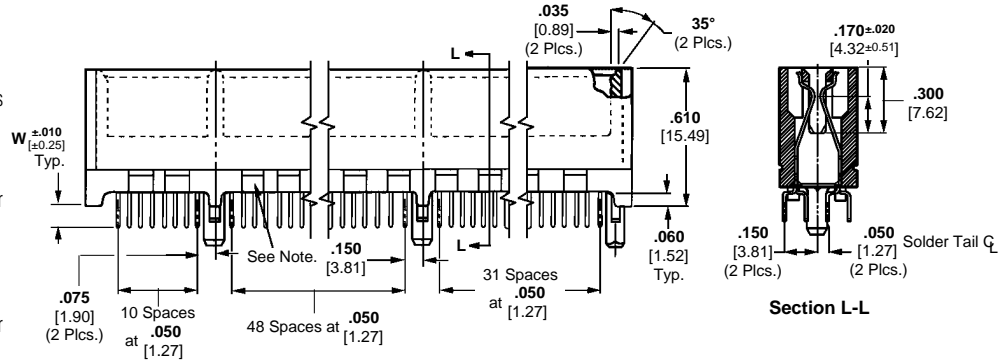
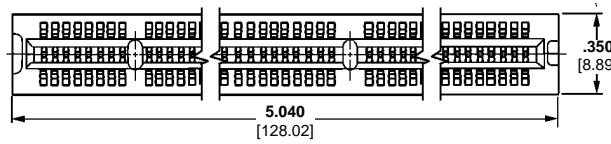

Section L-L

**Related Product Data:**

**Performance Specifications**—  
page 7

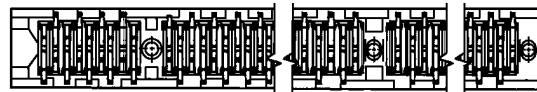

**Technical Documents:**

**Product Specification**  
108-14034

**Application Specification**  
114-26012

**Metal Holddowns**

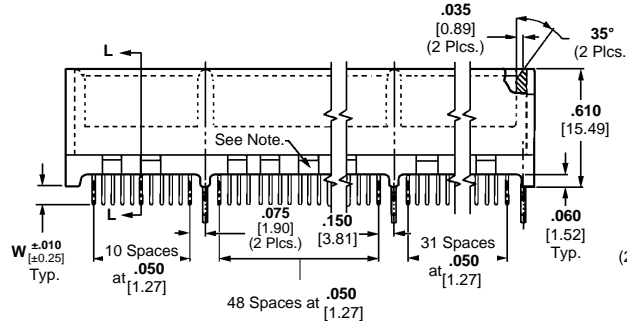

**Through Hole**

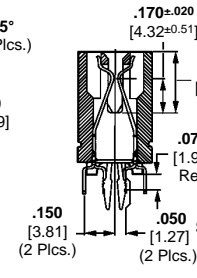

**Surface Mount**

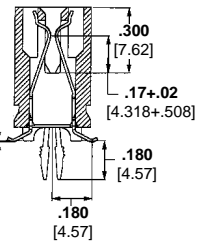

Section L-L



W (Post Length)	Contact Finish	Part Numbers	
		3 Plastic Pylons	3 Metal Holddowns
.100 2.54	Plating B	—	145168-2
	Plating C	145165-4	145168-4
.125 3.18	Plating C	145165-8	—
Surface Mount	Plating C	—	145246-1

**Notes:** 1. Connectors are supplied with either cored (shown above) or solid side walls.  
2. Other connector sizes can be made available, consult Tyco Electronics.

Solder Type Board-to-Board Connectors

**Standard Edge .050 Series Connectors**

**Product Facts**

- High density .050 [1.27] centerline spacing of contacts
- Easy mating of high-circuit count daughter boards
- Compatible with infrared reflow (IR) soldering techniques
- Polarizing web for positive board-to-connector registration
- Choice of plastic pylons or metal holddowns
- Recognized under the Component Program of Underwriter Laboratories Inc.  File No. E28476
- Certified by Canadian Standards Association,  File No. LR 7189

**Performance Specifications:**

**Contact Current Rating\*** — 1 ampere

**Termination Resistance** —  
20 milliohms max. (initial)  
30 milliohms max. (final)

**Dielectric Withstanding Voltage** —  
500 VAC min.

**Insulation Resistance** — 1000 megohms min.

**Mating Force** — .5 oz. [0.14 N] per contact pair

**Unmating Force** — 1 oz. [0.3 N] per contact pair

**Durability (Tested to)** — 100 mating cycles

**Application Temperature** —  
+215°C for 120 seconds max.

**Temperature Range** —  
-55°C to +85°C

\*Consult Tyco Electronics engineering when paralleling contacts for power applications.

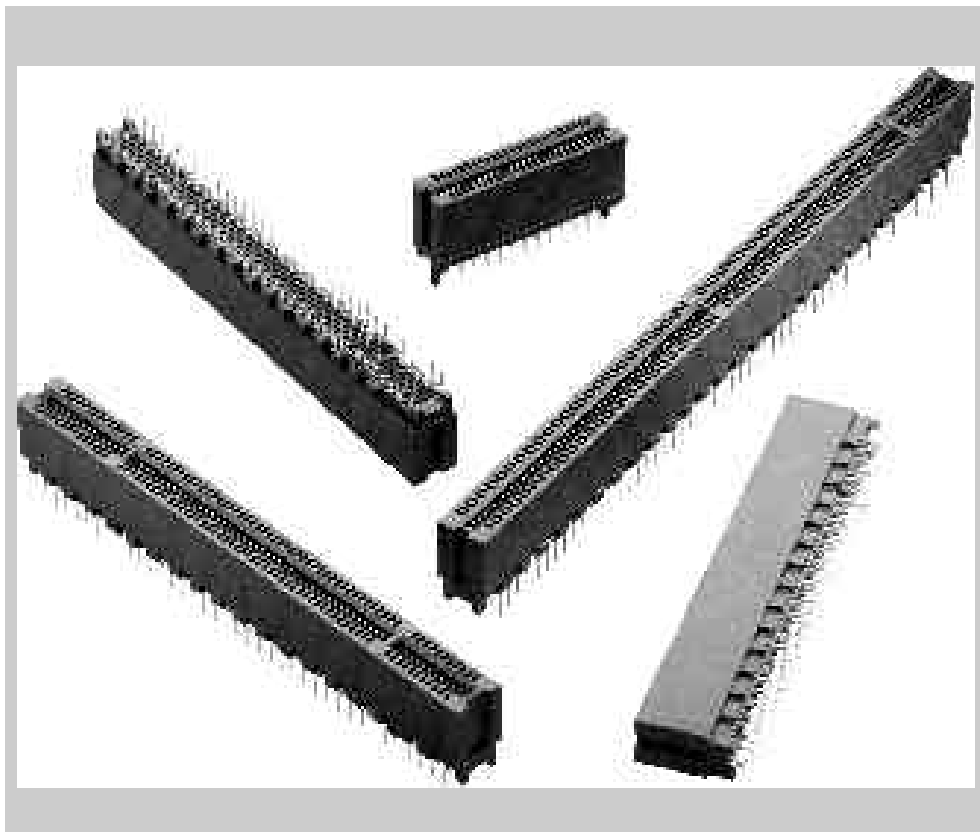

The need to conserve space and pack more function into a given area has demanded that .050 [1.27] centerline spacing become a reality. AMP Standard Edge .050 Series connectors are the ideal vehicle for mother/daughter board applications requiring this real estate.

These rugged connectors have two rows of contacts on .050 [1.27] centerlines. Polarizing webs provide positive board-to-connector registration, while insertion force allows even high circuit-count daughter boards to mate easily. The connectors accept .054 to .070 [1.37 to 1.78] thick daughter boards and feature an overstress protected contact design.

AMP Standard Edge .050 Series connectors are ideal for fast automated robotic assembly with registration features and dimensional tolerancing for more accurate pickup and placement, and are packaged in robotics-compatible trays.

Plastic guide posts or metal holddowns align the connector with the mother board and retain it for soldering. To make circuit routing easy, connector solder posts are arranged in a four-row .100 [2.54] staggered grid. High-temperature tolerant materials promote that these connectors withstand infrared reflow (IR) soldering, while standoffs ease flux cleaning.

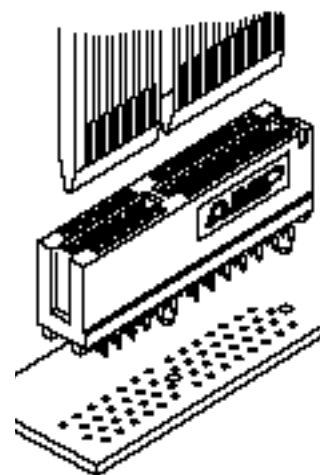

**High Density for DataBus Applications**



**Standard Edge .050 Series Connectors**

**Configuration;  
1 Key—2 Plastic Pylons**

**Material and Finish:**

**Housing**—High temperature thermo-plastic, brown

**Contacts**—Phosphor bronze, duplex plated .000030 [0.00076] min. gold in contact area, .000100 [0.00254] min. tin-lead on solder tails, with entire contact underplated .000050 [0.00127] min. nickel

**Related Product Data:**

**Performance Specifications**—page 11

**Technical Documents:**

**Product Specification**

108-14034

**Application Specification**

114-26012

Solder Type Board-to-Board Connectors

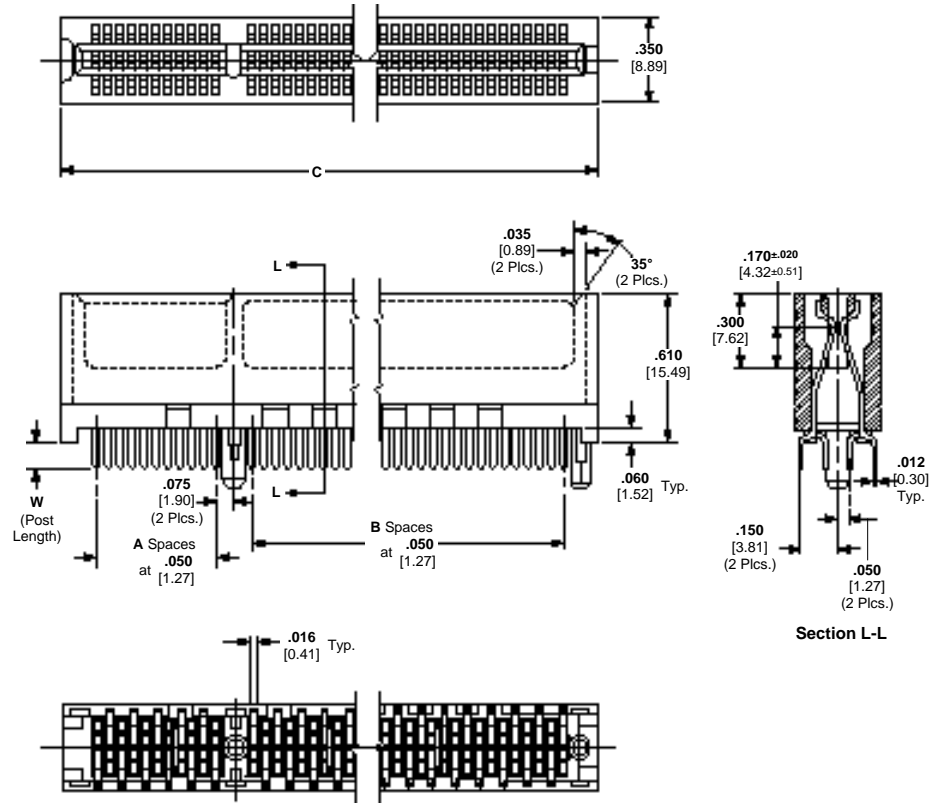

No. of Dual Positions	Dimensions			W (Post Length)	PC Board Hole Layout	Connector Part Numbers
	A	B	C			
23	10	11	1.490 37.85	.100 2.54	A	650090-7
30	10	18	1.840 46.74	.100 2.54	B	650090-6
40	10	28	2.340 59.44	.100 2.54	B	650090-3
				.140 3.56	B	650181-2
45	10	33	2.590 65.79	.100 2.54	A	650090-2
56	10	44	3.140 79.76	.100 2.54	B	650090-11
				.140 3.56	B	650181-1
80	37	41	4.340 110.24	.100 2.54	C	650090-9
91	41	48	4.890 124.21	.100 2.54	A	650092-12
				.140 3.56	A	650092-2

<sup>1</sup> Connector used for VLocal Bus and MCA Bus applications.

<sup>2</sup> Connector used for MCA Bus applications.

- Notes:** 1. Other connector sizes can be made available, consult Tyco Electronics.  
2. .125 [3.18] post length is available, consult Tyco Electronics.

**Standard Edge .050 Series Connectors**

Solder Type Board-to-Board Connectors

**Configuration;  
1 Key—2 Plastic Pylons**

**Material and Finish:**

**Housing**—High temperature thermo-plastic, brown

**Contacts**—Phosphor bronze, duplex plated .000030 [0.00076] min. gold in contact area, .000100 [0.00254] min. tin-lead on solder tails, with entire contact underplated .000050 [0.00127] min. nickel

**Related Product Data:**

**Performance Specifications**—page 11

**Technical Documents:**

**Product Specification**  
108-14034

**Application Specification**  
114-26012

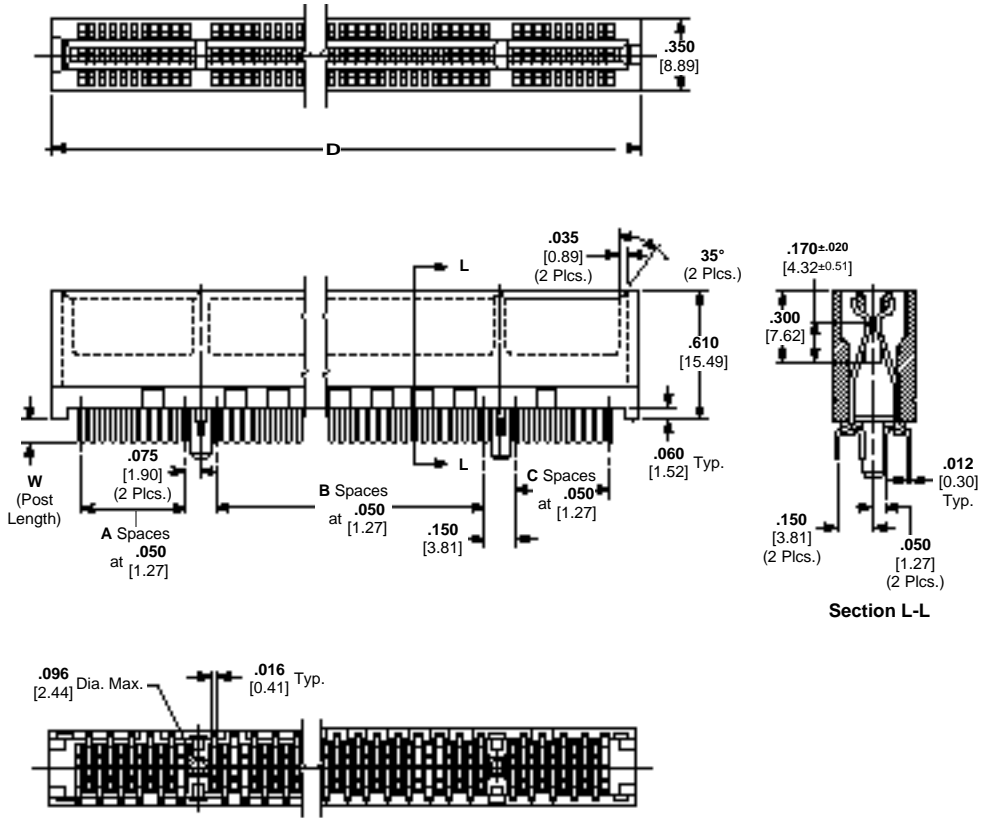

No. of Dual Positions	Dimensions				W (Post Length)	PC Board Hole Layout	Connector Part Numbers
	A	B	C	D			
66	10	44	9	3.740 95.00	.100 2.54	A	650091-1*
					.140 3.56	A	650091-2

\*Connectors used for MCA Bus applications.

- Notes:** 1. Other connector sizes can be made available, consult Tyco Electronics.  
2. .125 [3.18] post length is available, consult Tyco Electronics.

**Standard Edge .050 Series Connectors**

**Configuration;  
1 Key/1 Web —3 Metal  
Holddowns**

**120 Dual Positions**

**Material and Finish:**

**Housing**—High temperature thermo-plastic, brown

**Holddowns**—Brass, plated .000150 [0.00381] min. tin-lead over .000050 [0.00127] min. nickel

**Contacts**—Phosphor bronze, duplex plated .000030 [0.00076] min. gold in contact area, .000100 [0.00254] min. tin-lead on solder tails, with entire contact underplated .000050 [0.00127] min. nickel

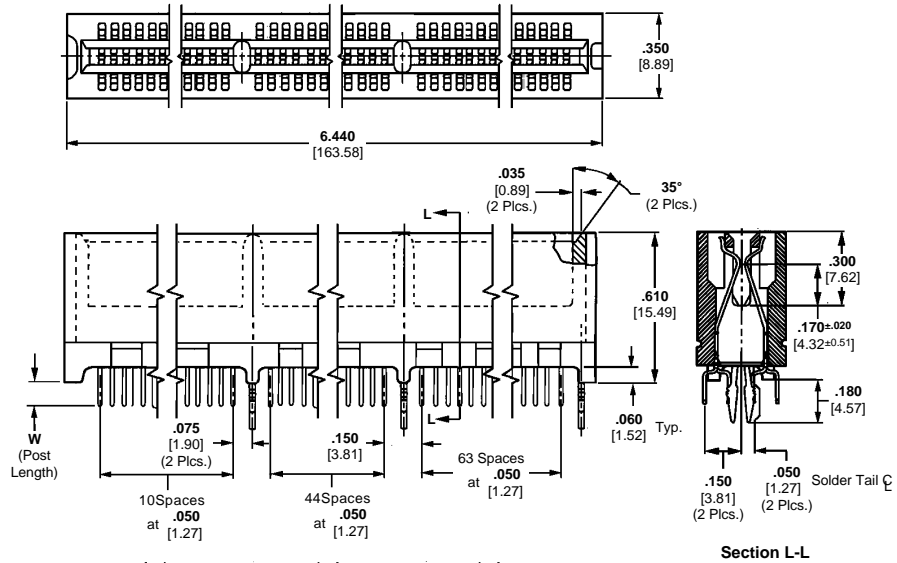

**Related Product Data:**

**Performance Specifications**— page 11

**Technical Documents:**

**Product Specification**  
104-14034

**Application Specification**  
114-26012

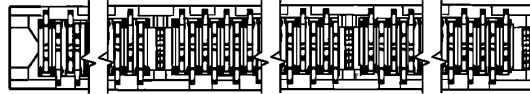

No. of Dual Positions	W (Post Length)	Connector Part Numbers
120	.140 3.56	145031-3

**Note:** Other connector sizes can be made available, consult Tyco Electronics.

**Configuration; End Key**

**Material and Finish:**

**Housing**—High temperature thermo-plastic, brown

**Contacts**—Phosphor bronze, duplex plated .000030 [0.00076] min. gold in contact area, .000100 [0.00254] min. tin-lead on solder tails, with entire contact underplated .000050 [0.00127] min. nickel

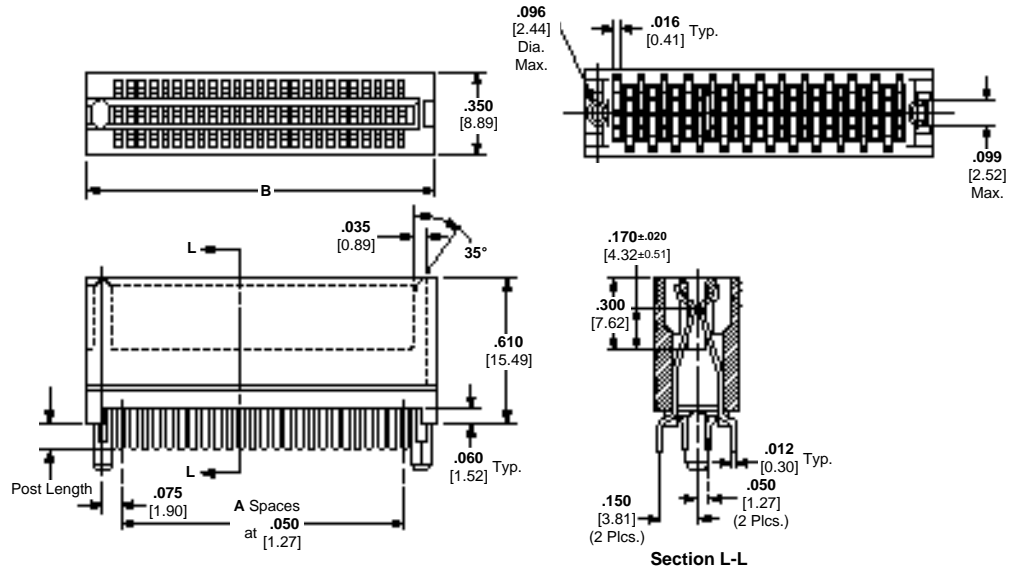

**Related Product Data:**

**Performance Specifications**— page 11

**Technical Documents:**

**Product Specification**  
108-14034

**Application Specification**  
114-26012

No. of Dual Positions	Dimensions				Post Length	Connector Part Numbers
	A	B	C	D		
25	24	1.480 37.59	1.350 34.29	1.310 33.27	.100 2.54	650719-1



**Note:** Other connector sizes can be made available, consult Tyco Electronics.

Solder Type Board-to-Board Connectors



**Standard Edge II Connectors**

**Product Facts**

- **Maximum number of dual positions**  
.100 [2.54] Centerlines-70,  
.125 [3.18] Centerlines-50,  
.150 [3.81] Centerlines-31
- **Selective gold plating of contacts for high performance at low cost**
- **.025 [0.64] square solid posts meet standard wrap-type specifications**
- **For flow solder applications**
- **Glass-filled polyester housing is 94V-0 rated**
- **Accepts double sided PC boards, .054-.070 [1.27-1.78] thick**
- **Recognized under the Component Program of Underwriters Laboratories Inc., File No. E28476** 
- **Certified by Canadian Standards Association, File No. LR 7189** 

**Performance Specifications**

- Contact Rating\***: 3 amperes continuous (UL and CSA)
- Contact Resistance**: 10 milliohms max.
- Operating Temperature**: -55°C to +85°C
- Voltage Rating (Sea Level)**:  
.100 [2.54] centerline—1000 VAC (test)  
.125 [3.18] centerline—1500 VAC (test)  
.150 [3.81] centerline—1500 VAC (test)
- Insulation Resistance**: 5000 megohms min., after exposure to humidity
- Vibration Tolerance**: 10 to 500 hertz
- Contact Engagement Force**: 12 oz [3.3 N] average per pair with .062 [1.57] PC board
- Contact Separation Force**: 2 oz [0.6 N] average per pair with .062 [1.57] PC board
- Humidity Tolerance**: 90%-95% for 96 hours

\*Consult Tyco Electronics engineering when paralleling contacts for power applications.

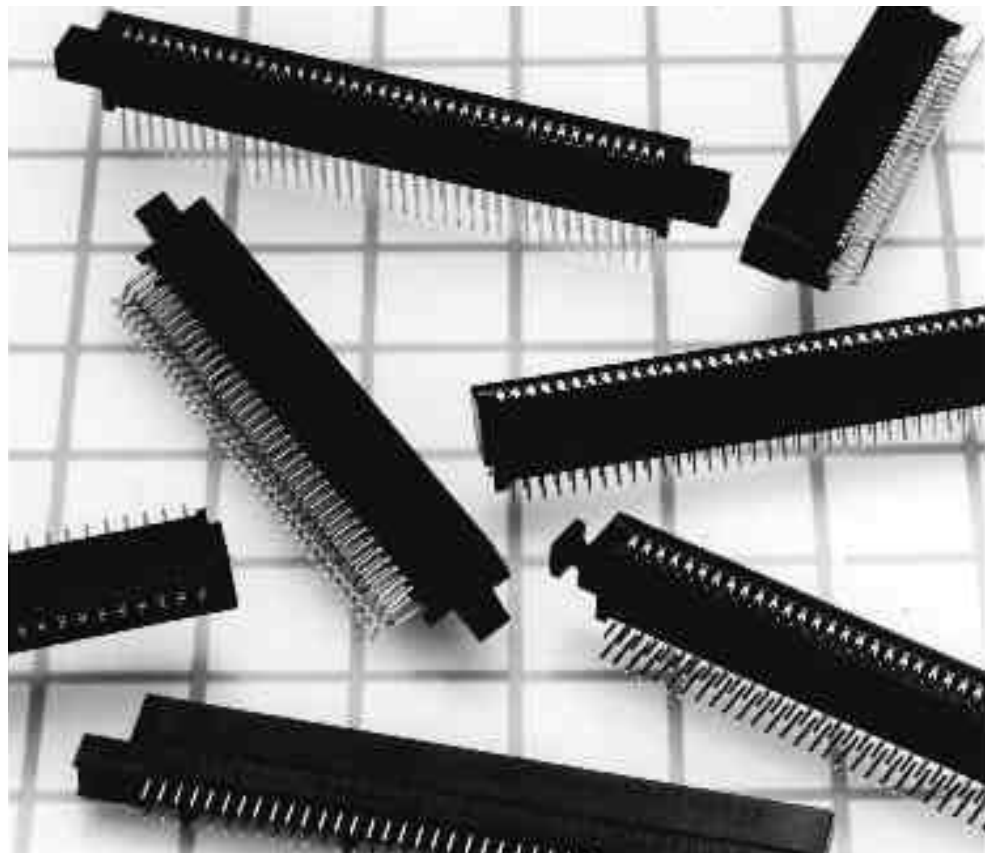

AMP Standard Edge II Connectors provide high reliability and economy in packages compatible with industry standards for double sided printed circuit boards.

Tyco Electronics offers Standard Edge II Connectors with or without mounting ears, for rack mounting and soldering. Contacts are arranged on .100 [2.54] centers, .125 [3.18] centers, .150 [3.81] centers, .200 [5.08] row-to-row; and .250 [6.35] row-to-row.

Right-angle connectors are also available with contacts arranged on .100 [2.54] centers, .150 [3.81] row-to-row or .200 [5.08] row-to-row.

Card extenders with contacts on .100 [2.54] and .125 [3.18] centers also are available.

Precision formed phosphor bronze contacts are selectively gold plated. Phosphor bronze has excellent strength characteristics which help the connector absorb load deflection movement of a PC board while maintaining sufficient contact force for good electrical connection. Bifurcated cantilever beam contacts provide redundant contact.

**.100 [2.54] and .125 [3.18] Centerline Solder Posts without Mounting Ears**  
Pages 17 and 18

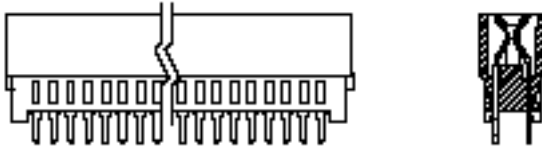

**.100 [2.54] and .125 [3.18] Centerline Solder Posts with Low and Mid-High Mounting Ears**  
Page 20

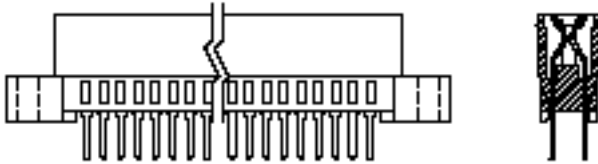

**.100 [2.54] and .125 [3.18] Centerline Wrap-Type Posts with Mid-High Mounting Ears**  
Page 21

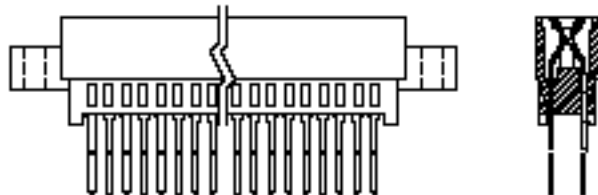

**.100 [2.54] and .125 [3.18] Centerline Card Extenders**  
Page 22

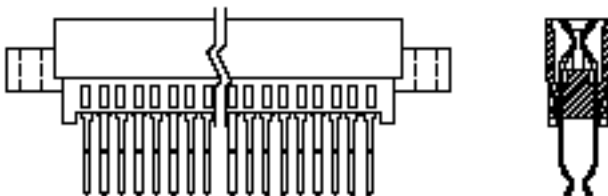

**.100 [2.54] Centerline Right-Angle Posts with Low and No Mounting Ears**  
Page 23

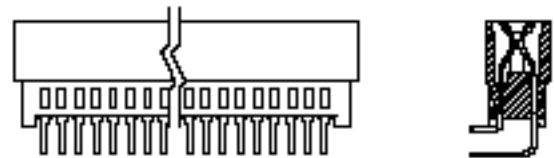
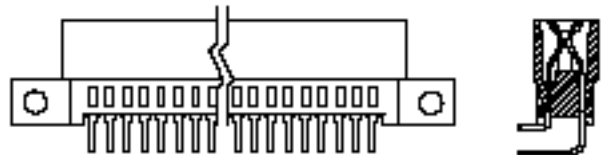
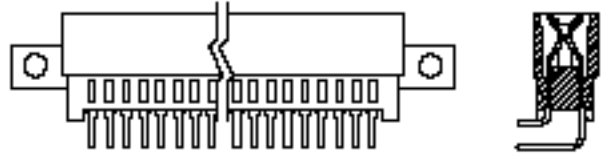

**.100 [2.54] Centerline Solder Posts with Board Retention Feature, without Mounting Ears**  
Page 24

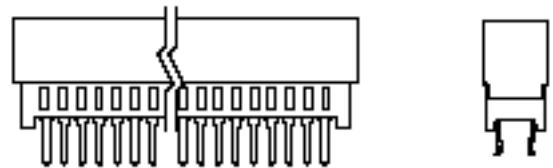

**.150 [3.81] Centerline Solder Posts (with Board Retention Feature), without Mounting Ears**  
Page 19

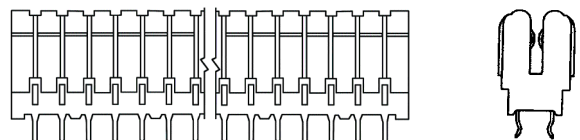

**Standard Edge II Card Edge Connectors**

**.100 [2.54] Centerline, Vertical Solder Posts, Without Mounting Ears**

**Material and Finish:**

**Housing**—Black glass-filled polyester, 94V-0 rated

**Contacts**—Phosphor bronze, duplex plated as follows:

**Plating A**—.000030 [0.00076] gold in contact area, tin on posts, with entire contact nickel underplated

**Plating B**—.000015 [0.00038] gold in contact area, tin on posts, with entire contact nickel underplated

**Plating C**—Gold flash in contact area, tin on posts, with entire contact nickel underplated

**Technical Documents:**

**Product Specification**

108-9039

**Intercontact Keying Plug**

**Material:**

Natural color polyester



**Part Number 650025-2**  
(.100 [2.54] Centerline)

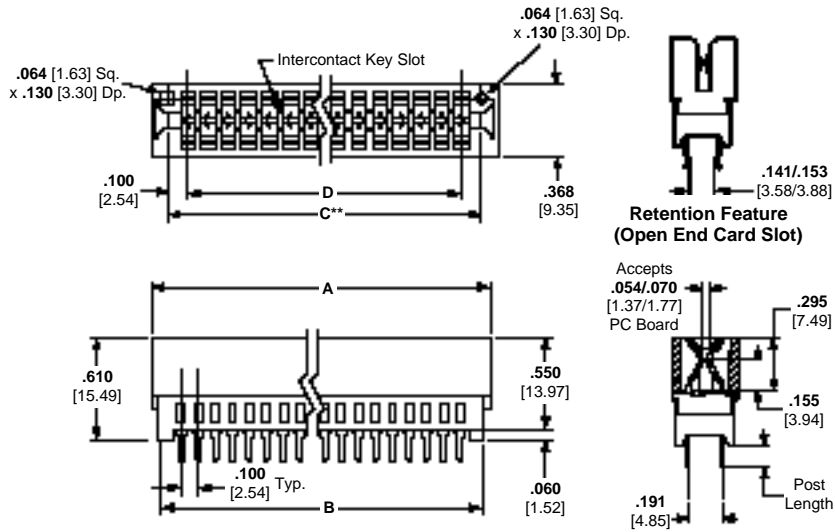

No. of Dual Positions	Dimensions				Post Length*	Part Numbers		
	A	B	C**	D		Plating A	Plating B	Plating C
3	.560 14.22	.450 11.43	Open End	.200 5.08	.125	650263-11	—	—
6	.860 21.84	.750 19.05	.700 17.78	.500 12.70	.125 .187	7-530843-5 7-530843-6	—	—
10	1.260 32.00	1.150 29.21	1.100 27.94	.900 22.86	.125 .187	5-530843-0 4-530843-9	—	—
12	1.460 37.08	1.350 34.29	1.300 33.02	1.100 27.94	.125	530843-1	—	—
15	1.760 44.70	1.650 41.91	1.600 40.64	1.400 35.56	.125	530843-2	—	—
17	1.960 49.78	1.850 46.99	1.800 45.72	1.600 40.64	.125	5-530843-3	—	—
18	2.060 52.32	1.950 49.53	1.900 48.26	1.700 43.18	.125	530843-3	2-530843-7	176137-11
20	2.260 57.40	2.150 54.61	2.100 53.34	1.900 48.26	.125	5-530843-4	—	—
22	2.460 62.48	2.350 59.69	2.300 58.42	2.100 53.34	.125	530843-4	—	—
25	2.760 70.10	2.650 67.31	2.600 66.04	2.400 60.96	.125	530843-5	—	—
28	3.060 77.72	2.950 74.93	2.900 73.66	2.700 68.58	.125	530843-6	—	—
30	3.260 82.80	3.150 80.01	3.100 78.74	2.900 73.66	.125 .187	530843-7 1-530843-8	—	—
31	3.360 85.34	3.250 82.55	3.200 81.28	3.000 76.20	.125	6-530843-5	7-530843-0	—
36	3.860 98.04	3.750 95.25	3.700 93.98	3.500 88.90	.125	530843-8	—	—
40	4.260 108.20	4.150 105.41	4.100 104.14	3.900 99.06	.187	2-530843-0	—	—
50	5.260 133.60	5.150 130.81	5.100 129.54	4.900 124.46	.125	1-530843-1	—	—

\*Metric equivalent for post lengths are .125 = 3.18; .187 = 4.75.

\*\*C dimension is card slot length.

† Connectors with Retention Feature.

**Notes:** 1. Other connector sizes can be made available, consult Tyco Electronics.  
2. High temperature IR reflow compatible connectors can be made available, consult Tyco Electronics.



**Standard Edge II Connectors** (Continued)

**.125 [3.18] Centerline, Vertical Solder Posts, Without Mounting Ears**

**Material and Finish:**

**Housing**—Black glass-filled polyester, 94V-0 rated

**Contacts**—Phosphor bronze, plated with .000030 [0.00076] gold in contact area, tin on posts, with entire contact nickel underplated

**Related Product Data:**

**Performance Specifications**—page 15

**PC Board Hole Layout**—page 26

**PC Board Edge Pattern**—page 27

**Special Application**—page 96

**Technical Documents:**

(pages 186, 187):

Product Specification  
108-9039

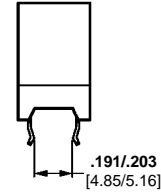
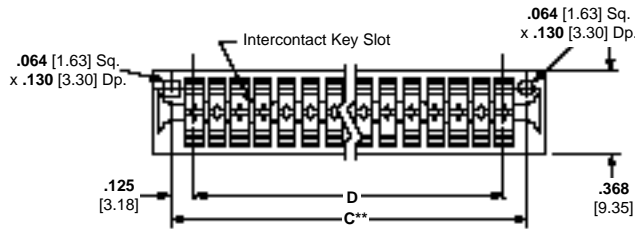

Retention Feature

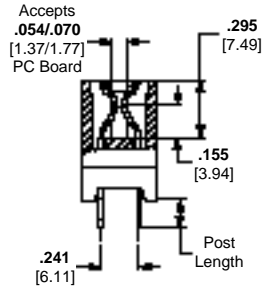
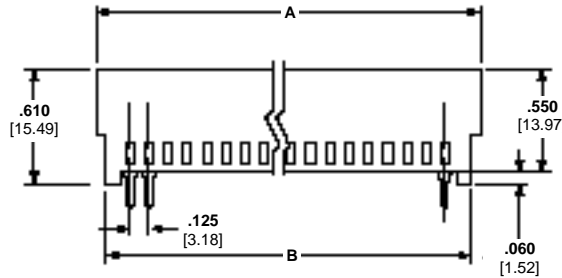

**Intercontact Keying Plug**

**Material:**

Natural color polyester

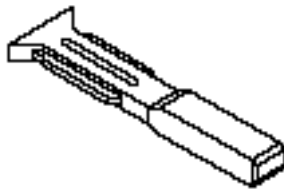

Part No. 650025-1  
(.125 [3.18] Centerline)

No. of Dual Positions	Dimensions				Post Length*	Part Numbers
	A	B	C**	D		
6	1.035 26.29	.875 22.22	.875 22.22	.625 15.88	.125	650207-11
14	2.035 51.69	1.875 47.62	1.875 47.62	1.625 41.28	.187	5-530844-8
18	2.535 64.39	2.375 60.33	2.375 60.33	2.125 53.98	.187	1-530844-5
22	3.035 77.09	2.875 73.03	2.875 73.03	2.625 66.68	.187	1-530844-6
28	3.785 96.14	3.625 92.08	3.625 92.08	3.375 85.73	.187	1-530844-7
30	4.035 102.49	3.875 98.42	3.875 98.42	3.625 92.08	.187	1-530844-8
36	4.785 121.54	4.625 117.48	4.625 117.48	4.375 111.13	.187	1-530844-9
40	5.285 134.24	5.125 130.18	5.125 130.18	4.875 123.82	.187	2-530844-0
43	5.660 143.76	5.500 139.70	5.500 139.70	5.250 133.35	.125	1-530844-0
50	6.535 165.99	6.375 161.93	6.375 161.93	6.125 155.58	.125 .187	1-530844-1 2-530844-2

\*Metric equivalent for post lengths are .125 = [3.18]; .187 = [4.75]

\*\*C dimension is card slot length.

†Connector with Retention Feature.

**Note:** Other connector sizes can be made available, consult Tyco Electronics.

**Standard Edge II Connectors** (Continued)

**.150 [3.81] Centerline, Vertical Solder Posts, Retention Feature, Without Mounting Ears**

**Material and Finish:**

**Housing**—Black glass-filled polyester, 94V-0 rated

**Contacts**—Phosphor bronze, plated with .000030 [0.00076] gold in contact area, tin on posts, with entire contact nickel underplated

**Related Product Data:**

**Performance Specifications**—

page 15

**PC Board Hole Layout**—page 26

**PC Board Edge Pattern**—page 27

**Special Application**—page 96

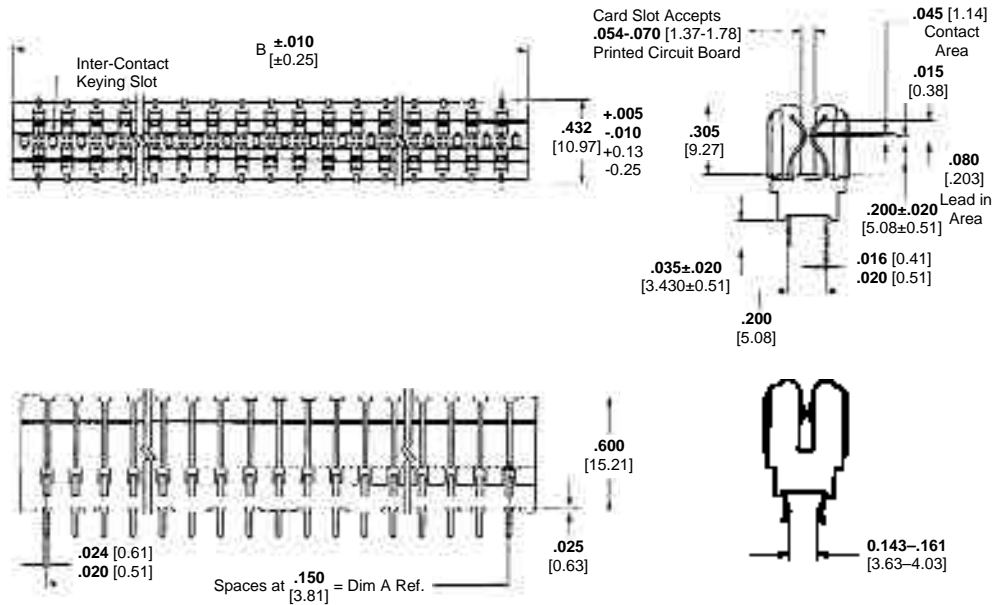

Solder Type Board-to-Board Connectors

No. of Dual Positions	Dimensions		Retention Location	Post Length*	Part Numbers
	A	B			
12	1.650 41.91	1.920 48.77	7-10, 15-18	.135	1-650728-2
19	2.700 68.58	2.970 75.44	7-10, 29-32	.135	1-650728-9
28	4.050 102.87	4.320 109.73	7-10, 25-32,47-50	.135	2-650728-9
31	4.500 114.30	4.770 121.16	7-10, 27-34,53-56	.135	3-650728-1

\*Metric equivalent for post length is .135 = [3.43]

\*\*C dimension is card slot length.

**Note:** Other connector sizes can be made available, consult Tyco Electronics.

**.100 [2.54] and .125 [3.18] Centerline, Vertical Solder Posts, Low and Mid-High Mounting Ears**

**Material and Finish:**

**Housing**—Black glass-filled polyester, 94V-0 rated

**Contacts**—Phosphor bronze, plated with .000030 [0.00076] gold in contact area, tin on posts, with entire contact nickel underplated

**Related Product Data:**

**Performance Specifications**—page 15

**PC Board Hole Layout**—page 26

**PC Board Edge Pattern**—page 27

**Special Application**—page 96

**Technical Documents:**

(pages 186, 187):

Product Specification  
108-9039

**Intercontact Keying Plugs**

**Material:**

Natural color polyester



**Part No. 650025-2**  
(.100 [2.54] Centerline)

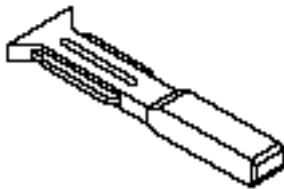

**Part No. 650025-1**  
(.125 [3.18] Centerline)

**Standard Edge II Connectors (Continued)**

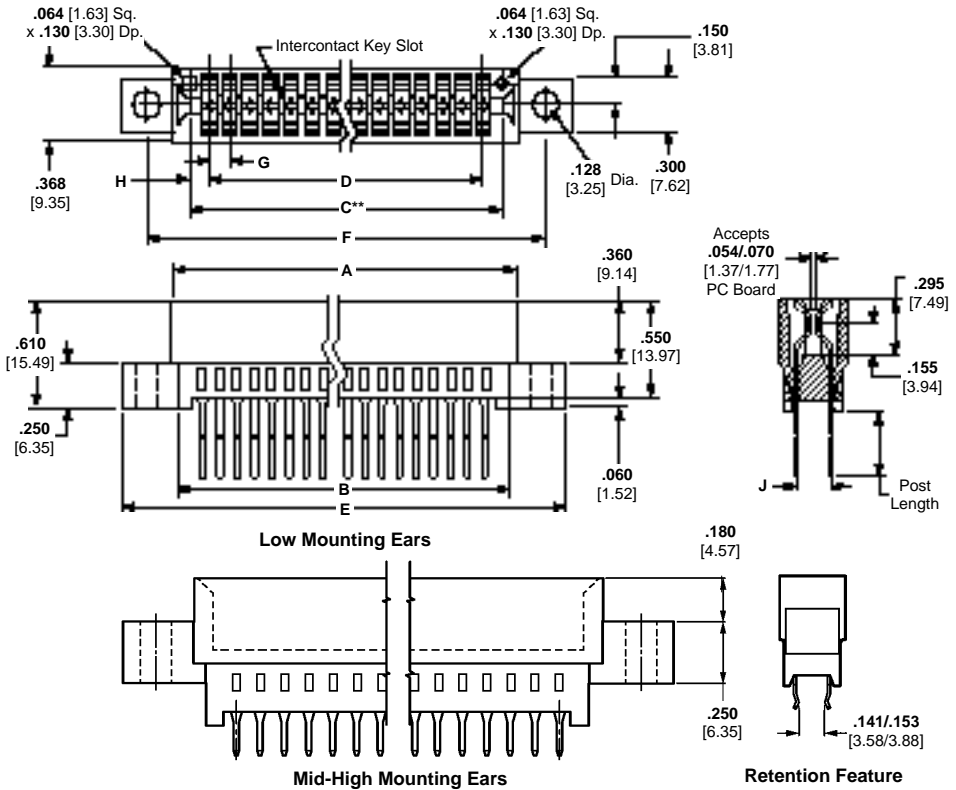

**.100 [2.54] Centerline**

No. of Dual Positions	Dimensions									Post Length*	Part Numbers
	A	B	C**	D	E	F	G	H	J		
15	1.760 44.70	1.650 41.91	1.600 40.64	1.400 35.56	2.385 67.18	2.075 52.71	.100 2.54	.100 2.54	.191 4.85	.125	530841-2
18	2.060 52.32	1.950 49.53	1.900 48.26	1.700 43.18	2.645 67.18	2.375 60.32	.100 2.54	.100 2.54	.191 4.85	.125	530841-3
25	2.760 70.10	2.650 67.31	2.600 66.04	2.400 60.96	3.345 84.96	3.075 78.11	.100 2.54	.100 2.54	.191 4.85	.125 .187	530841-5 1-530841-6
30	3.260 82.80	3.160 80.01	3.100 78.74	2.900 73.66	3.845 97.66	3.575 90.81	.100 2.54	.100 2.54	.191 4.85	.187	1-530841-8
36	3.860 98.04	3.750 95.25	3.700 93.98	3.500 88.90	4.445 112.90	4.175 106.21	.100 2.54	.100 2.54	.191 4.85	.125	530841-8
50	5.260 133.60	5.150 130.81	5.100 129.54	4.900 124.46	5.845 148.46	5.575 141.60	.100 2.54	.100 2.54	.191 4.85	.125 .187	1-530841-1 2-530841-2
									.141-.153 3.58-3.88	.125	650718-11 <sup>2</sup>

\*Metric equivalent for post lengths are .125 = [3.18]; .187 = [4.75]

\*\*C dimension is card slot length.

<sup>1</sup>Connector with Retention Feature.

<sup>2</sup>Connector with Mid-High Mounting Ears.

**Note:** Other connector sizes can be made available, consult Tyco Electronics.

**.125 [3.18] Centerline**

No. of Dual Positions	Dimensions									Post Length*	Part Numbers
	A	B	C**	D	E	F	G	H	J		
6	1.035 26.29	.875 22.22	.875 22.22	.625 15.88	1.555 39.50	1.295 32.89	.125 3.18	.125 3.18	.241 6.11	.125	1-531341-3
28	3.785 96.14	3.505 89.03	3.625 92.08	3.375 85.73	4.305 109.35	4.045 102.74	.125 3.18	.125 3.18	.241 6.11	.187	1-530842-7
50	6.535 165.99	6.255 158.88	6.375 161.93	6.125 155.58	7.055 179.20	6.795 172.59	.125 3.18	.125 3.18	.241 6.11	.125	3-531341-0 <sup>2</sup> 1-530842-1

\*Metric equivalent for post lengths are .125 = [3.18]; .187 = [4.75]

\*\*C dimension is card slot length.

<sup>1</sup>Connector with Retention Feature.

<sup>2</sup>Connector with Mid-High Mounting Ears.

**Note:** Other connector sizes can be made available, consult Tyco Electronics.

**Standard Edge II Connectors** (Continued)

**.100 [2.54] and .125 [3.18] Centerline, Vertical Wrap-Type Posts, Mid-High Mounting Ears**

**Material and Finish:**  
**Housing**—Black glass-filled polyester, 94V-0 rated  
**Contacts**—Phosphor bronze, plated with .000030 [0.00076] gold in contact area, tin on posts, with entire contact nickel underplated

**Related Product Data:**  
**Performance Specifications**—page 15  
**PC Board Hole Layout**—page 26  
**PC Board Edge Pattern**—page 27  
**Special Application**—page 96

**Technical Documents:**  
 (pages 186, 187):  
 Product Specification 108-9039

**Intercontact Keying Plugs**  
**Material:**  
 Natural color polyester



**Part No. 650025-2**  
 (.100 [2.54] Centerline)

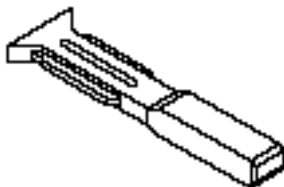

**Part No. 650025-1**  
 (.125 [3.18] Centerline)

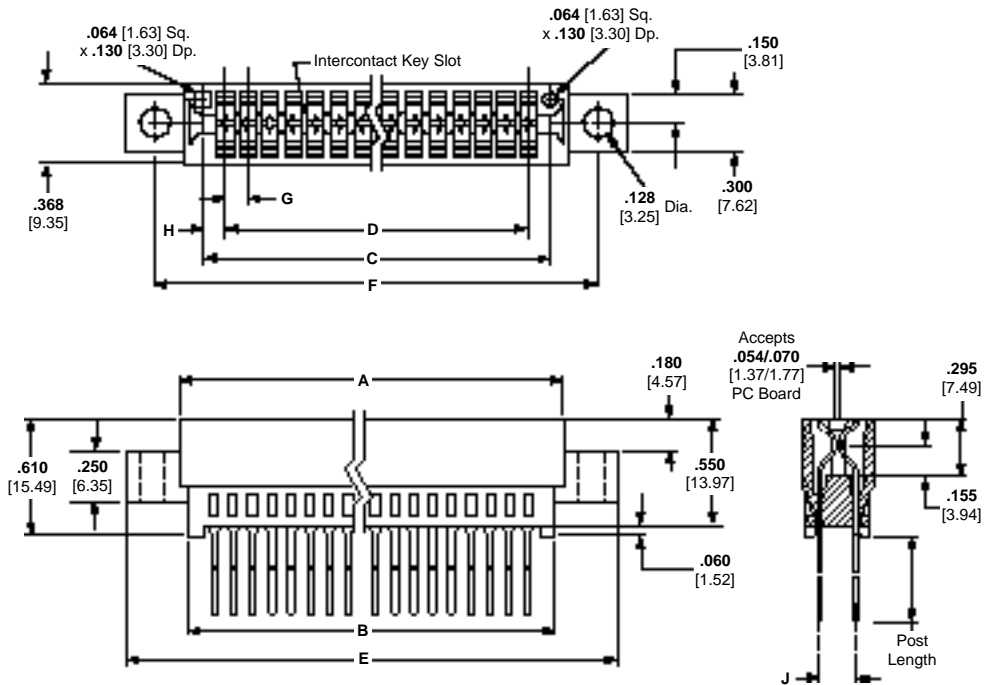

**.100 [2.54] Centerline**

No. of Dual Positions	Dimensions									Post Length*	Part Numbers
	A	B	C**	D	E	F	G	H	J		
30	3.260	3.150	3.100	2.900	3.845	3.575	.100	.100	.200	.570	3-530396-3
	82.80	80.01	78.74	73.66	97.41	90.80	2.54	2.54	5.08		
36	3.860	3.750	3.700	3.500	4.435	4.175	.100	.100	.200	.570	3-530396-4
	98.04	95.25	93.98	88.90	112.65	106.04	2.54	2.54	5.08		
40	4.260	4.150	4.100	3.900	4.845	4.575	.100	.100	.200	.570	3-530396-4
	108.20	105.41	104.14	99.06	123.06	116.21	2.54	2.54	5.08		

\*Metric equivalent for post length is .570 = [14.48].  
 \*\*C dimension is card slot length.

**Note:** Other connector sizes can be made available, consult Tyco Electronics.

**.125 [3.18] Centerline**

No. of Dual Positions	Dimensions									Post Length*	Part Numbers
	A	B	C**	D	E	F	G	H	J		
22	3.035	2.755	2.875	2.625	3.555	3.295	.125	.125	.250	.570	4-530825-5
	77.09	69.98	73.02	66.67	90.30	83.69	3.18	3.18	6.35		

\*Metric equivalent for post length is .570 = [14.48].  
 \*\*C dimension is card slot length.

**Note:** Other connector sizes can be made available, consult Tyco Electronics.



**Standard Edge II Connectors (Continued)**

**.100 [2.54] and .125 [3.18] Centerlines, Card Extender Contacts**

**Material and Finish:**

**Housing**—Black glass-filled polyester, 94V-0 rated

**Contacts**—Phosphor bronze, plated with .000030 [0.00076] gold in contact area, tin on posts, with entire contact nickel underplated

**Related Product Data:**

**Performance Specifications**—page 15

**PC Board Hole Layout**—page 26

**PC Board Edge Pattern**—page 27

**Technical Documents:**

(pages 186, 187):

Product Specification 108-9039

**Mounting Block**

**Material:**

Natural color nylon

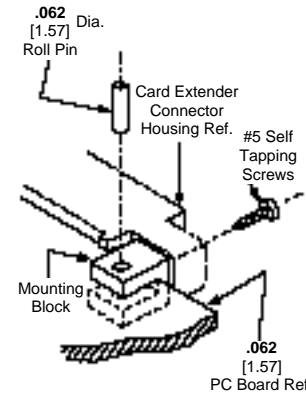

**Kit Part No. 531250-4**

Each kit includes 2 mounting blocks, 2 self tapping screws, #5 x .437 [11.10] and 2 roll pins, .075 x .250 [1.57 x 6.35]

**Intercontact Keying Plugs**

**Material:**

Natural color polyester

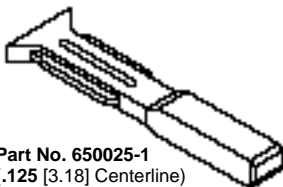

**Part No. 650025-1**  
(.125 [3.18] Centerline)



**Part Number 650025-2**  
(.100 [2.54] Centerline)

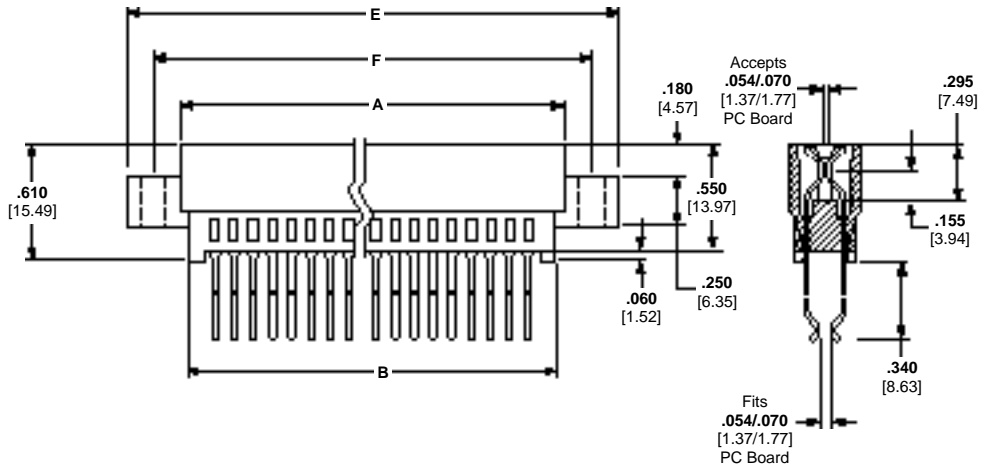
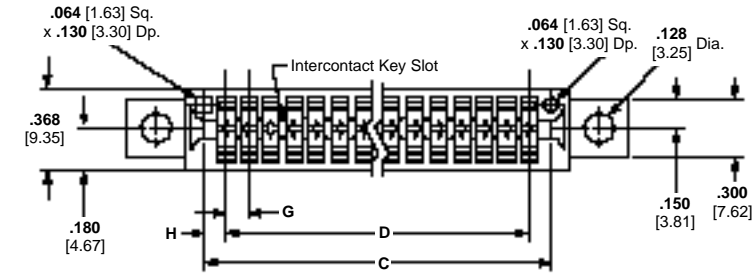

**.100 [2.54] Centerline**

No. of Dual Positions	Dimensions								Part Numbers
	A	B	C**	D	E	F	G	H	
50	5.260 133.60	5.160 130.81	5.100 129.54	4.900 124.46	5.845 148.46	5.575 141.60	.100 2.54	.100 2.54	530826-3

\*C dimension is card slot length.

†No mounting ears.

**Note:** Other connector sizes can be made available, consult Tyco Electronics.

**.125 [3.18] Centerline**

No. of Dual Positions	Dimensions								Part Numbers
	A	B	C**	D	E	F	G	H	
36	4.785 121.54	4.505 114.43	4.625 117.48	4.375 111.13	5.035 134.75	5.045 128.14	.125 3.18	.125 3.18	530384-2

\*C dimension is card slot length.

**Note:** Other connector sizes can be made available, consult Tyco Electronics.

**Standard Edge II Card Edge Connectors**

**.100 [2.54] Right-Angle Solder Posts, with Low and No Mounting Ears**

**Material and Finish:**

**Housing**—Black glass-filled polyester, 94V-0 rated

**Contacts**—Phosphor bronze, duplex plated as follows:

**Plating A**—.000030 [0.00076] gold in contact area, tin on posts, with entire contact nickel underplated

**Plating B**—.000015 [0.00038] gold in contact area, tin on posts, with entire contact nickel underplated

**Related Product Data:**

**Performance Specifications**—page 15

**Technical Documents:**

**Product Specification**  
108-9039

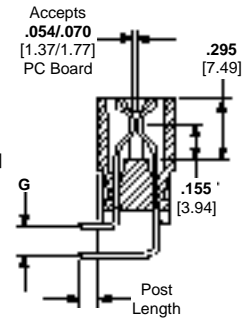
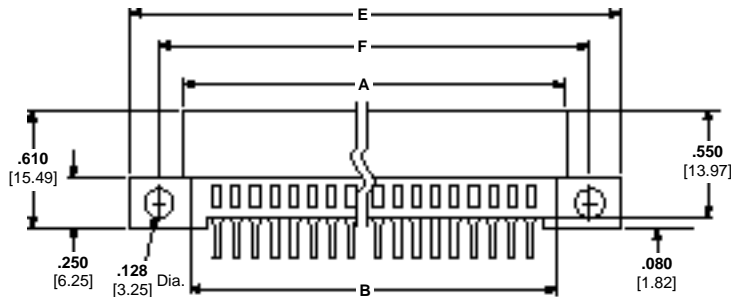
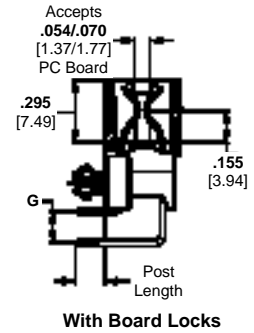
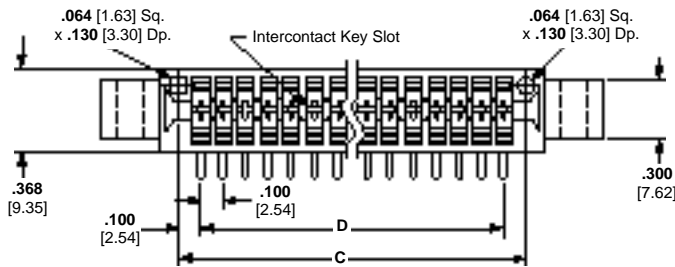

Low Mounting Ears

**Intercontact Keying Plug**

**Material:**

Natural color polyester



**Part Number 650025-2**  
(.100 [2.54] Centerline)

**Low Mounting Ears**

No. of Dual Positions	Dimensions							Post Length <sup>2</sup>	Part Numbers (Plating A)
	A	B	C*	D	E	F	G <sup>1</sup>		
12	1.460	1.350	1.300	1.100	2.045	1.775	.100x	.090	145089-1 <sup>3</sup>
	37.08	34.29	33.02	27.94	51.94	45.08	.150		
18	2.060	1.950	1.900	1.700	2.645	2.375	.100x	.090	645384-1
	52.32	49.53	48.26	43.18	67.18	60.32	.150		
20	2.260	2.150	2.100	1.900	2.845	2.575	.100x	.090	645384-3
	57.40	54.61	53.34	48.26	72.30	65.40	.150		

\*C dimension is card slot length.

<sup>1</sup> Metric equivalent for .100 x .150 and .100 x .200 are [2.54 x 3.81] and [2.54 x 5.08].

<sup>2</sup> Metric equivalent for post length is .090 = [2.27].

<sup>3</sup> Connector with Board Locks.

**Note:** Other connector sizes can be made available, consult Tyco Electronics.

**No Mounting Ears**

No. of Dual Positions	Dimensions					Post Length <sup>2</sup>	Part Numbers	
	A	B	C*	D	G <sup>1</sup>		Plating A	Plating B
15	1.760	1.650	1.600	1.400	.100x	.090	650118-1	—
	44.70	41.91	40.64	35.56	.150			
17	1.960	1.850	1.800	1.600	.100x	.090	650187-1	—
	49.78	46.99	45.72	40.64	.200			
25	2.760	2.350	2.600	2.400	.100x	.090	—	532600-2
	70.10	67.61	66.04	60.96	.150			
31	3.360	3.250	3.200	3.000	.100x	.090	—	532600-4
	85.34	82.55	81.28	76.20	.150			
32	3.460	3.350	3.300	3.100	.100x	.090	—	532600-5
	87.88	85.09	83.82	78.74	.150			
19	2.160	2.750	2.700	1.800	.100x	.090	—	532600-6
	54.86	69.85	68.58	45.72	.150			

\*C dimension is card slot length.

<sup>1</sup> Metric equivalent for .100 x .150 and .100 x .200 are [2.54 x 3.81] and [2.54 x 5.08].

<sup>2</sup> Metric equivalent for post length is .090 = [2.27].

**Notes:** 1. Other connector sizes can be made available, consult Tyco Electronics.

2. High temperature IR reflow compatible connectors can be made available, consult Tyco Electronics.

**Standard Edge II Card Edge Connectors**

**.100 [2.54] Centerline Vertical Solder Posts, Retention Feature, Without Mounting Ears**

**Material and Finish:**

**Housing**—Black glass-filled polyester, 94V-0 rated

**Contacts**—Phosphor bronze, duplex plated as follows:

**Plating A**—.000030 [0.00076] gold in contact area, tin on posts, with entire contact nickel underplated

**Plating B**—.000015 [0.00038] gold in contact area, tin on posts, with entire contact nickel underplated

**Plating C**—Gold flash in contact area, tin on posts, with entire contact nickel underplated

**Technical Documents:**

**Product Specification**  
108-9039

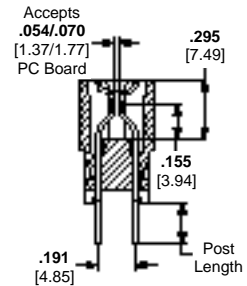
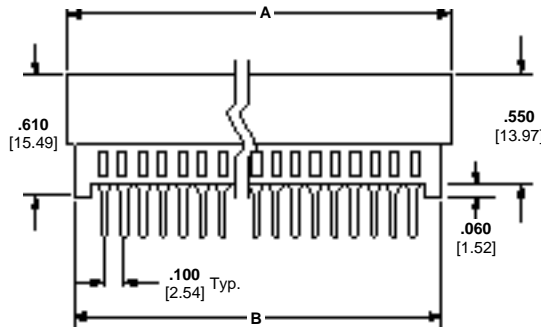
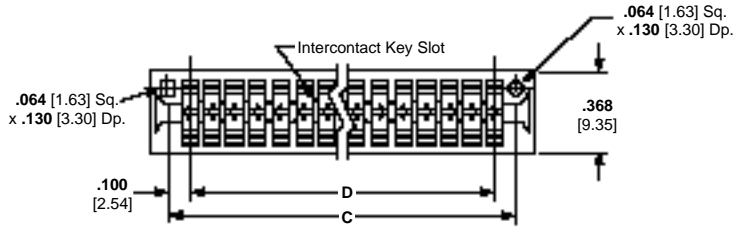

**Intercontact Keying Plug**

**Material:**

Natural color polyester

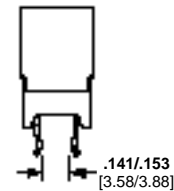

Retention Feature

**Part Number 650025-2**  
(.100 [2.54] Centerline)

No. of Dual Positions	Dimensions				Post Length*	Retention Feature	PartNumbers Plating A
	A	B	C**	D			
18	<b>2.060</b>	<b>1.950</b>	<b>1.900</b>	<b>1.700</b>	.125	3-6, 31-34	645235-4
	52.32	49.53	48.26	43.18			
31	<b>3.360</b>	<b>3.250</b>	<b>3.200</b>	<b>3.000</b>	.125	3-6, 29-32 or 31-34, 57-60	645235-1
	85.34	82.55	81.28	76.20			
50	<b>5.260</b>	<b>5.150</b>	<b>5.100</b>	<b>4.900</b>	.125	3-6, 49-52, 95-98	645235-3
	133.60	130.81	129.54	124.46			
60	<b>6.260</b>	<b>6.150</b>	<b>6.100</b>	<b>5.900</b>	.125	3-6, 55-58, 63-66, 115-118	645235-8
	159.00	156.21	154.94	149.86			

\*Metric equivalent for post length is .125 = [3.18].

\*\*C dimension is card slot length.

**Notes:** 1. Other connector sizes can be made available, consult Tyco Electronics.  
2. High temperature IR reflow compatible connectors can be made available, consult Tyco Electronics.

**Standard Edge II Card Edge Connectors**

Solder Type Board-to-Board Connectors

**.100 [2.54] Centerline, Special 18/31 Dual Combination Connector, Vertical Solder Posts, Without Mounting Ears**

**Material and Finish:**

**Housing**—Black glass-filled polyester, 94V-0 rated, except where noted

**Contacts**—Phosphor bronze, plated with .000030 [0.00076] gold in contact area (except where noted), tin on posts, with entire contact nickel underplated

**Technical Documents:**

**Product Specification**  
108-9039

**Intercontact Keying Plug**

**Material:**

Natural color polyester



**Part Number 650025-2**  
(.100 [2.54] Centerline)

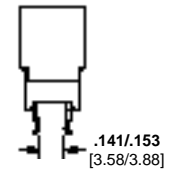
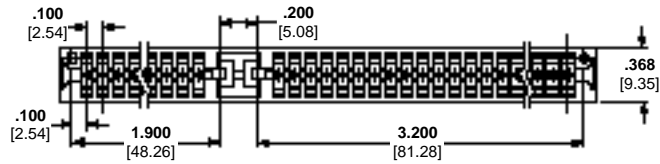

Retention Feature

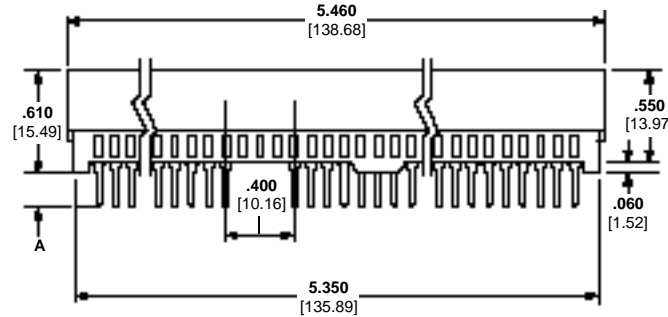

Accepts  
**.054/.070**  
[1.37/1.77]  
PC Board

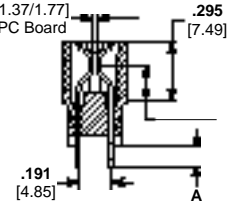

Solder Posts

No. of Dual Positions	Post Type	Dimension A	Retention Feature	Part Numbers
52	Solder Posts	.125 3.18	3-6, 41, 42, 51, 52, 93-96	645169-2 536128-1 <sup>1</sup>
52	Solder Posts	.125 3.18	None	645169-3
52	Solder Posts	.125 3.18	3-14, 41, 42, 51, 52, 85-96	645169-4
52	Solder Posts	.125 3.18	5, 6, 31, 32, 41, 42, 93, 94	176139-1 <sup>2</sup>
52	Solder Posts	.187 4.75	None	650616-1

<sup>1</sup> Housing material is high temperature glass-filled polyester, gray.  
<sup>2</sup> Contact area is gold flash.

- Notes:**
1. Card slot length is **5.300** [134.62].
  2. Other connector sizes can be made available, consult Tyco Electronics.
  3. High temperature IR reflow compatible connectors can be made available, consult Tyco Electronics.



Recommended  
PC Board Hole Layouts

**Standard Edge II Connectors** (Continued)

**Vertical Post Connectors**

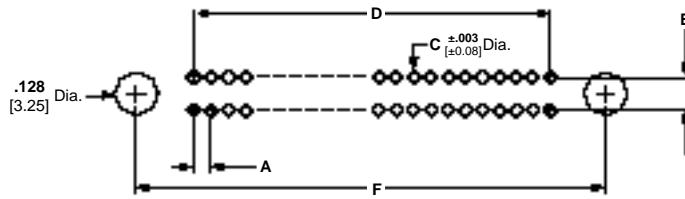

Connector Type	Dimensions				
	A	B	C	D	F
Solder Post/Retention	.100 2.54	.200 5.08	.040 1.02	See Note 1	See Note 2
Solder Post/Retention	.150 3.81	.200 5.08	.040 1.02	See Note 4	See Note 2
Solder Post, Mounting Ears	.125 3.18	.250 6.35	.040 1.02	See Note 3	See Note 3
Solder Post, W/O Mounting Ears	.100/.125 2.54/3.18	.200/.250 5.08/6.35	.040 1.02	See Note 4	See Note 2
Wrap-Type Post	.100 2.54	.200 5.08	.042 1.07	See Note 5	See Note 5
Wrap-Type Post	.125 3.18	.250 6.35	.042 1.07	See Note 5	See Note 5

- Notes:**
1. Refer to page 24 for D Dimensions and Dual Positions.
  2. No mounting ears. Dimensions do not apply.
  3. Refer to page 20 for D and F Dimensions and Dual Positions.
  4. Refer to pages 18 and 19 for D Dimensions and Dual Positions.
  5. Refer to page 21 for D and F Dimensions and Dual Positions.

**Right-Angle Post Connectors**

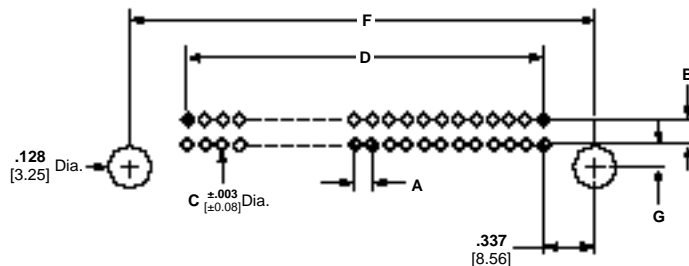

Connector Type	Dimensions					
	A	B	C	D	F	G
Right-Angle Posts, Mounting Ears	.100 2.54	.150 3.81	.042 1.07	See Note 1	See Note 1	.137 3.48
Right-Angle Posts, No Mounting Ears	.100 2.54	.150 or .200 3.81 or 5.08	.042 1.07	See Note 2	See Note 3	See Note 3

- Notes:**
1. Refer to page 23 for D and F Dimensions and Dual Positions.
  2. Refer to page 23 for D Dimensions and Dual Positions.
  3. No Mounting Ears, Dimensions do not apply.

Solder Type Board-to-Board Connectors

**Standard Edge II Connectors** (Continued)

**Recommended  
PC Board Edge Pattern**

**PC Board Edge Pattern for  
.100 [2.54] and .125 [3.18]  
Centerline**

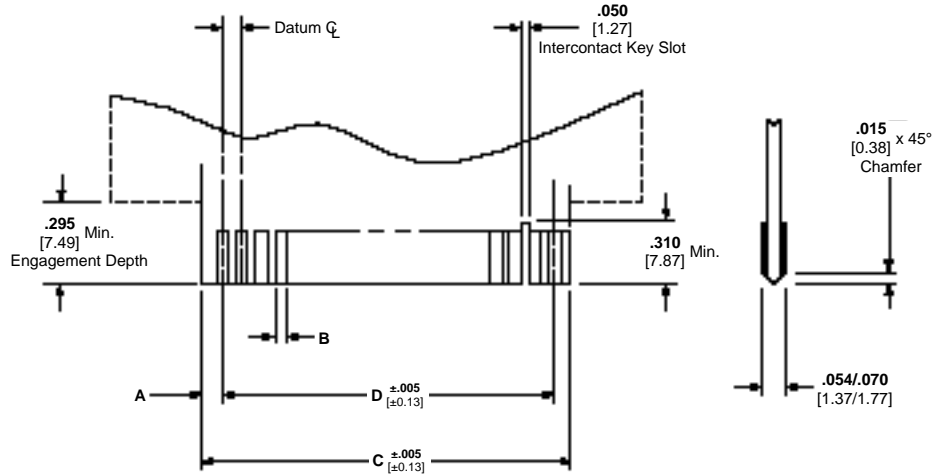

Solder Type Board-to-Board  
Connectors

No. of Dual Positions	.100 [2.54] Centerline A = .093 [2.36] B = .050 [1.27]		.125 [3.18] Centerline A = .118 [3.00] B = .075 [1.90]	
	C	D	C	D
3	.386 9.80	.200 5.08	—	—
6	.686 17.42	.500 12.70	.861 21.87	.625 15.88
10	1.086 27.58	.900 22.86	1.361 34.57	1.125 28.58
12	1.286 32.66	1.100 27.94	—	—
13	1.386 35.20	1.200 30.48	—	—
14	—	—	1.861 47.27	1.625 41.28
15	1.586 40.28	1.400 35.56	—	—
17	1.786 45.36	1.600 40.64	—	—
18	1.886 47.90	1.700 43.18	2.361 59.97	2.125 53.98
22	2.286 58.06	2.100 53.34	2.861 72.67	2.625 66.68
25	2.586 65.68	2.400 60.96	—	—
28	2.886 73.30	2.700 68.58	3.611 91.72	3.375 85.73
30	3.086 78.38	2.900 73.66	3.861 98.07	3.625 92.08
31	3.186 80.92	3.000 76.20	3.986 101.24	3.750 95.25
35	3.586 91.08	3.400 86.36	—	—
36	3.686 93.62	3.500 88.90	4.611 117.12	4.375 111.13
40	4.086 103.78	3.900 99.06	5.111 129.82	4.875 123.82
43	4.386 111.40	4.200 106.68	5.486 139.34	5.250 133.35
50	5.086 129.18	4.900 124.46	6.361 161.57	6.125 155.58
60	6.086 154.58	5.900 149.86	—	—
70	7.086 179.98	6.900 175.26	—	—

**Cantilever Series Card Edge Connectors**

**Product Facts**

- Double readout Card Edge connectors use dip solder contacts
- Large lead-in chamfers allow easy PC board installation
- Insulator standoffs prevent solder from wicking
- Various lengths for custom applications
- Contact option, single or dual row

Solder Type Board-to-Board Connectors

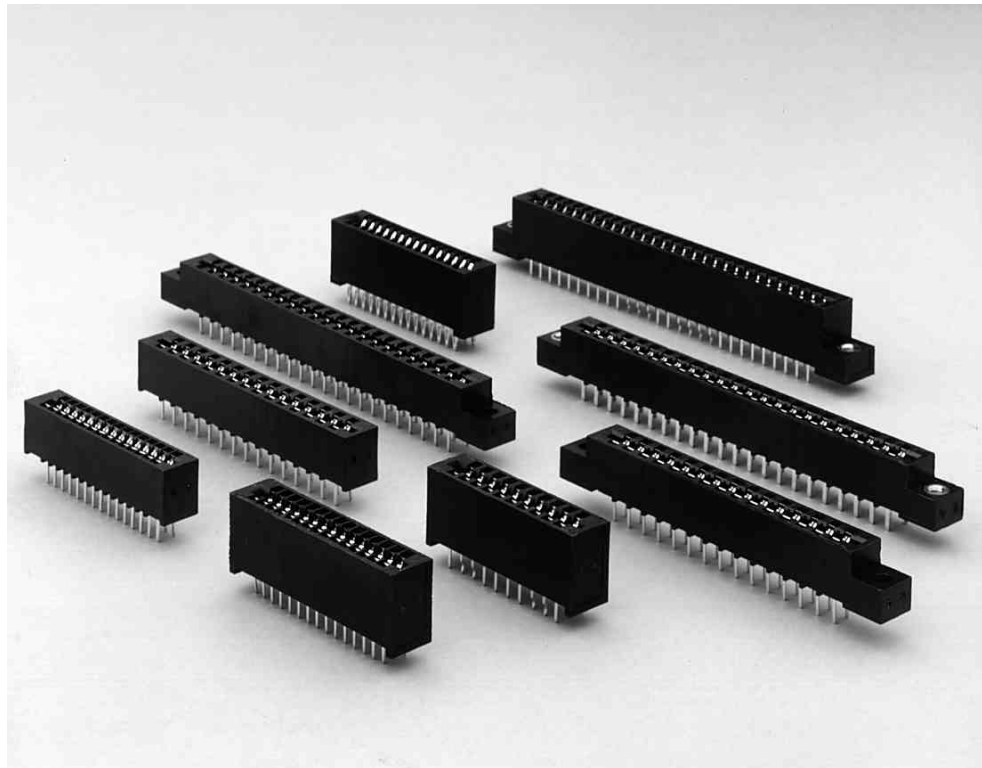

**Description**

The Cantilever Beam Series products from Tyco Electronics are double readout cardedge connectors, using dip solder contacts. Tooled for flexible manufacturing, these Card Edge connectors are readily available in a broad assortment of sizes and mounting styles. Our connectors meet industry standards.

**Design Advantages**

- **Circuit Integrity:** Robust cantilever contacts are designed to promote optimal normal forces at the lowest possible cost. Our uniquely contoured contact mating surface gives you constant engagement, even when subjected to continuous vibration.
- **Ease of Assembly:** Generous lead-in chamfers let your P.C. board slide easily into the connector. Insulator standoffs are provided to facilitate cleaning and prevent solder from wicking.

Availability, flexibility, performance and very low cost make the Cantilever Series from Tyco Electronics the clear choice in Card Edge connectors.

**Cantilever Beam**

The Cantilever Beam Card Edge connector comes with standard high temperature plastic insulators. Contacts are available in a variety of lengths to accommodate various custom applications. Standoffs allow for cleaning and draining and are available as an option on most insulator bodies.

Cantilever Beam Card Edge offers a variety of card slot depths. A full scoop option is available for ease of installation in applications where visibility is limited.

Contact options vary in this series from dual row standard contacts, single row options and press-fit.

**Cantilever Series Connectors .100 x .200 [2.54 x 5.08] Centerline**

**Product Facts**

- **Recognized under the Component Program of Underwriters Laboratories Inc., File No. E60980** 
- **Certified by Canadian Standards Association, File No. LR49571** 



**Physical Properties:**

- Insulation Resistance**—5000 megohms minimum.
- Insertion/Withdrawal Force (Daughter Card)**—8 oz./2 oz. [35.6 N/ 8.9 N] average contact pair using .0620 [1.57] steel blade.
- Insulator Body**—Glass filled thermoplastic, UL rating 94V-0. High temp. plastic option is available; add suffix M399 to part number.
- Color**—Black
- Contacts**—High strength copper alloy.
- Contact Plating**—.000050 [0.00127] nickel underplate with .000030 [0.00076] gold in the mating area, tin/lead on tails, .000100 [0.00254] minimum

**Electrical Properties:**

- Operation Voltage**—600 VDC (sea level)
- Current Rating**—3 Amperes
- Initial Contact Resistance**—10 milliohms

**Environmental Properties:**

- Operating Temperature**—-55°C to +125°C
- Temperature Cycling**—MIL-STD-202 method 107

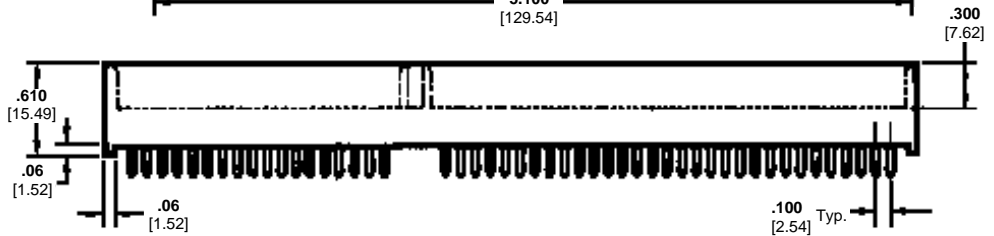
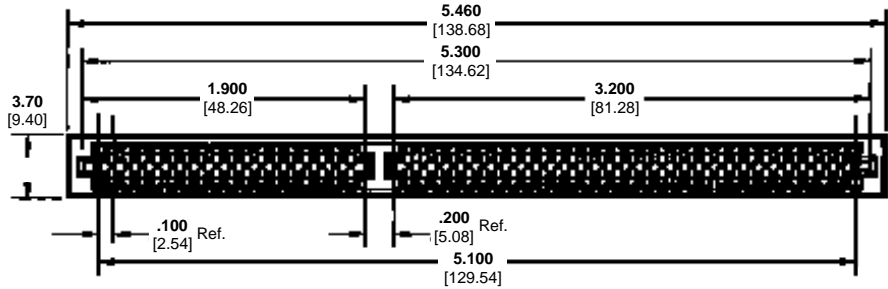
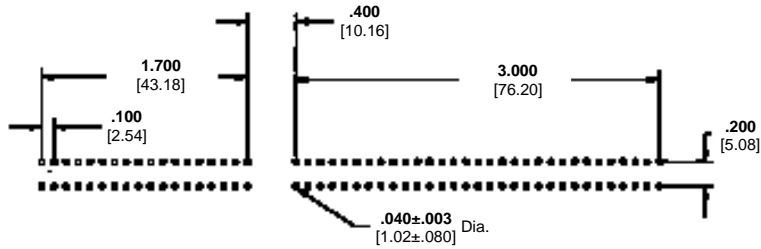
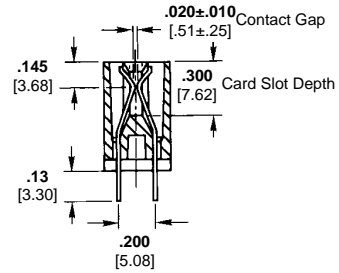

**Ordering Information**

**Acquired Part Number**

- C8D52DS29C1M191** – Insulator with molded-in polarizing key with card guide chamber. The card slot lengths are 1.900 [48.26] and 3.200 [81.28]. Includes retention tails for .062 [1.57] PCB to hold connectors securely during handling.
- C8D52DS29C1M195** – Same as above. No retention tails.



**Cantilever Series Connectors .100 x .200 [2.54 x 5.08] Centerline  
Dip Solder Tails, .300 [7.62] Card Slot Depth**

**Product Facts**

- Recognized under the Component Program of Underwriters Laboratories Inc., File No. E60980 
- Certified by Canadian Standards Association, File No. LR49571 

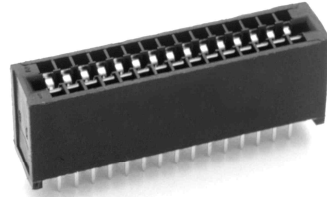

**Physical Properties:**

**Insulation Resistance**—5000 megohms minimum.  
**Insertion/Withdrawal Force (Daughter Card)**—8 oz./2 oz. [35.6 N/ 8.9 N] average contact pair using .0620 [1.57] steel blade.  
**Insulator Body**—Glass filled thermoplastic, UL rating 94V-0. High temp. plastic option is available; add suffix M399 to part number.

**Color**—Black  
**Contacts**—High strength copper alloy.  
**Contact Plating**—.000050 [0.00127] nickel underplate with .000030 [0.00076] gold in the mating area, tin/lead on tails, .000100 [0.00254] minimum

**Electrical Properties:**  
**Operation Voltage**—600 VDC (sea level)  
**Current Rating**—3 Amperes  
**Initial Contact Resistance**—10 milliohms

**Environmental Properties:**  
**Operating Temperature**—-55°C to +125°C  
**Temperature Cycling**—MIL-STD-202 method 107

**Vibration**—MIL-STD-202 method 204

**Related Product Data:**  
**Daughter Card Edge Pattern**—page 57

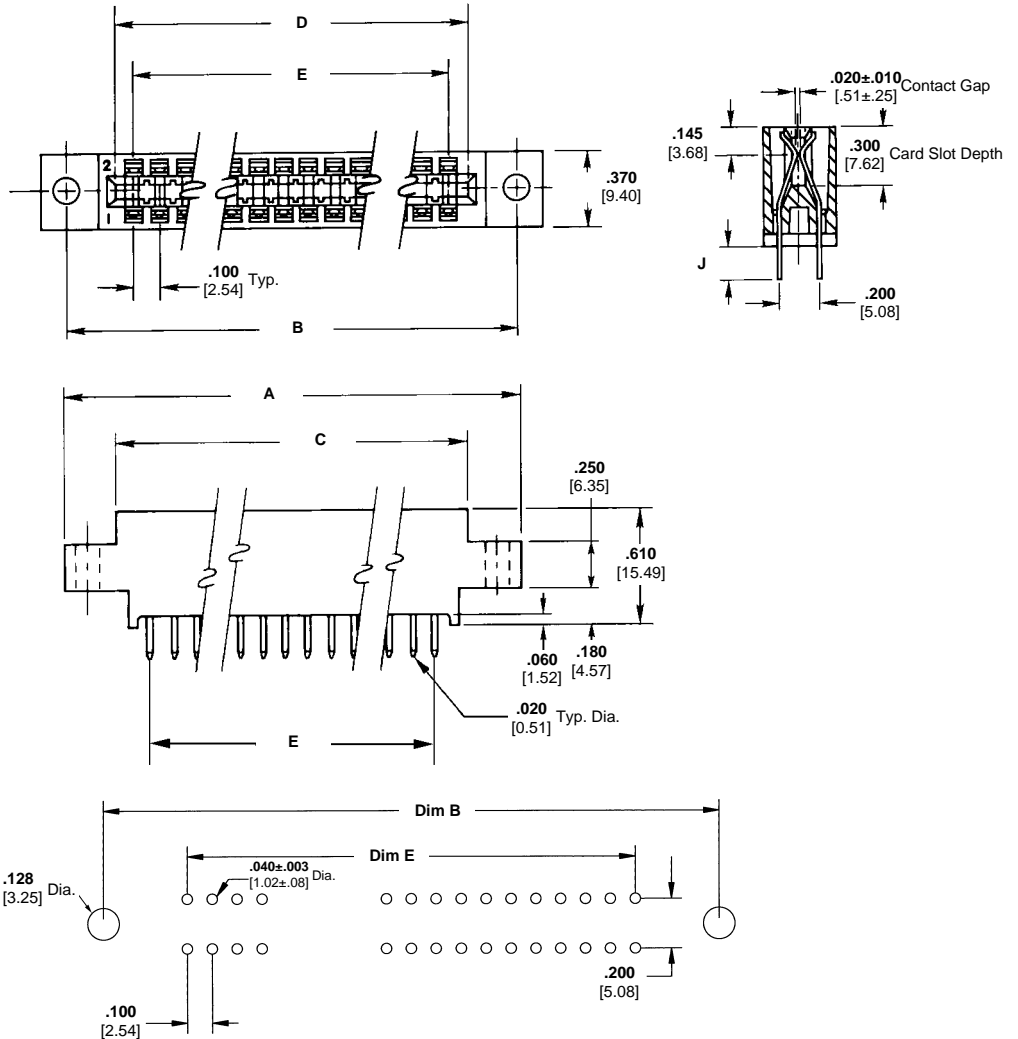

**Mounting Styles**

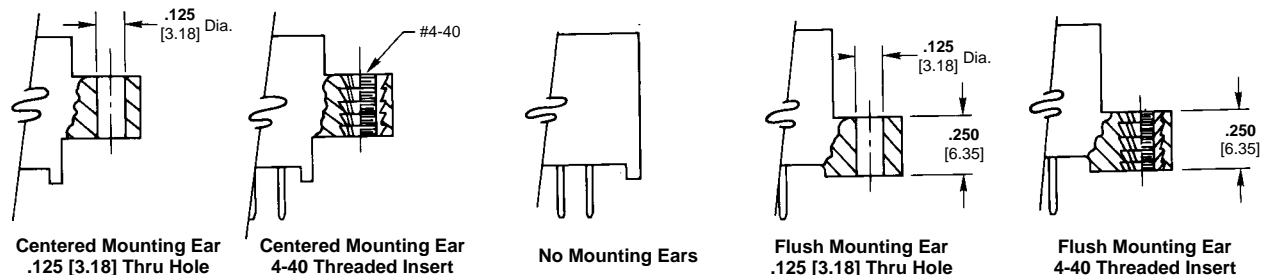

**Ordering Information**

.100" [2.54] Centerline / .200" [5.08] Row-to-Row

No. of Dual Readout Positions	Dimensions					Mounting Ear Options				
	A	B	C	D	E	Centered Mounting Ear .125" [3.18] Thru Hole	Centered Mounting Ear 4-40 Threaded insert	No Mounting Ears	Flush Mounting Ear .125" [3.18] Thru Hole	Flush Mounting Ear 4-40 Threaded insert
<b>Tail Length .130" [3.30] (DIM "J")</b>										
6	1.435 36.45	1.175 29.85	0.860 21.84	0.700 17.78	0.500 12.70	C8D06DS29A1	C8D06DS29B1	C8D06DS29C1	C8D06DS29D1	C8D06DS29E1
10	1.835 46.61	1.575 40.01	1.260 32.00	1.100 27.94	0.900 22.86	C8D10DS29A1	C8D10DS29B1	C8D10DS29C1	C8D10DS29D1	C8D10DS29E1
12	2.035 51.69	1.775 45.09	1.460 37.08	1.300 33.02	1.100 27.94	C8D12DS29A1	C8D12DS29B1	C8D12DS29C1	C8D12DS29D1	C8D12DS29E1
15	2.335 59.31	2.075 52.71	1.760 44.70	1.600 40.64	1.400 35.56	C8D15DS29A1	C8D15DS29B1	C8D15DS29C1	C8D15DS29D1	C8D15DS29E1
18	2.635 66.93	2.375 60.33	2.060 52.32	1.900 48.26	1.700 43.18	C8D18DS29A1	C8D18DS29B1	C8D18DS29C1	C8D18DS29D1	C8D18DS29E1
20	2.835 72.01	2.575 65.41	2.260 57.40	2.100 53.34	1.900 48.26	C8D20DS29A1	C8D20DS29B1	C8D20DS29C1	C8D20DS29D1	C8D20DS29E1
22	3.035 77.09	2.775 70.49	2.460 62.48	2.300 58.42	2.100 53.34	C8D22DS29A1	C8D22DS29B1	C8D22DS29C1	C8D22DS29D1	C8D22DS29E1
25	3.335 84.71	3.075 78.11	2.760 70.10	2.600 66.04	2.400 60.96	C8D25DS29A1	C8D25DS29B1	C8D25DS29C1	C8D25DS29D1	C8D25DS29E1
28	3.635 92.33	3.375 85.73	3.060 77.72	2.900 73.66	2.700 68.58	C8D28DS29A1	C8D28DS29B1	C8D28DS29C1	C8D28DS29D1	C8D28DS29E1
30	3.835 97.41	3.575 90.81	3.260 82.80	3.100 78.74	2.900 73.66	C8D30DS29A1	C8D30DS29B1	C8D30DS29C1	C8D30DS29D1	C8D30DS29E1
31	3.935 99.95	3.675 93.35	3.360 85.34	3.200 81.28	3.000 76.20	C8D31DS29A1	C8D31DS29B1	C8D31DS29C1	C8D31DS29D1	C8D31DS29E1
35	4.335 110.11	4.075 103.51	3.760 95.50	3.600 91.44	3.400 86.36	C8D35DS29A1	C8D35DS29B1	C8D35DS29C1	C8D35DS29D1	C8D35DS29E1
36	4.435 112.65	4.175 106.05	3.860 98.04	3.700 93.98	3.500 88.90	C8D36DS29A1	C8D36DS29B1	C8D36DS29C1	C8D36DS29D1	C8D36DS29E1
40	4.835 122.81	4.575 116.21	4.260 108.20	4.100 104.14	3.900 99.06	C8D40DS29A1	C8D40DS29B1	C8D40DS29C1	C8D40DS29D1	C8D40DS29E1
43	5.135 130.43	4.875 123.83	4.560 115.82	4.400 111.76	4.200 106.68	C8D43DS29A1	C8D43DS29B1	C8D43DS29C1	C8D43DS29D1	C8D43DS29E1
50	5.835 148.21	5.575 141.61	5.260 133.60	5.100 129.54	4.900 124.46	C8D50DS29A1	C8D50DS29B1	C8D50DS29C1	C8D50DS29D1	C8D50DS29E1
60	6.835 173.61	6.575 167.01	6.260 159.00	6.100 154.94	5.900 149.86	C8D60DS29A1	C8D60DS29B1	C8D60DS29C1	C8D60DS29D1	C8D60DS29E1
<b>Tail Length .160" [4.06] (DIM "J")</b>										
6	1.435 36.45	1.175 29.85	0.860 21.84	0.700 17.78	0.500 12.70	C8D06DS29A2	C8D06DS29B2	C8D06DS29C2	C8D06DS29D2	C8D06DS29E2
10	1.835 46.61	1.575 40.01	1.260 32.00	1.100 27.94	0.900 22.86	C8D10DS29A2	C8D10DS29B2	C8D10DS29C2	C8D10DS29D2	C8D10DS29E2
12	2.035 51.69	1.775 45.09	1.460 37.08	1.300 33.02	1.100 27.94	C8D12DS29A2	C8D12DS29B2	C8D12DS29C2	C8D12DS29D2	C8D12DS29E2
15	2.335 59.31	2.075 52.71	1.760 44.70	1.600 40.64	1.400 35.56	C8D15DS29A2	C8D15DS29B2	C8D15DS29C2	C8D15DS29D2	C8D15DS29E2
18	2.635 66.93	2.375 60.33	2.060 52.32	1.900 48.26	1.700 43.18	C8D18DS29A2	C8D18DS29B2	C8D18DS29C2	C8D18DS29D2	C8D18DS29E2
20	2.835 72.01	2.575 65.41	2.260 57.40	2.100 53.34	1.900 48.26	C8D20DS29A2	C8D20DS29B2	C8D20DS29C2	C8D20DS29D2	C8D20DS29E2
22	3.035 77.09	2.775 70.49	2.460 62.48	2.300 58.42	2.100 53.34	C8D22DS29A2	C8D22DS29B2	C8D22DS29C2	C8D22DS29D2	C8D22DS29E2
25	3.335 84.71	3.075 78.11	2.760 70.10	2.600 66.04	2.400 60.96	C8D25DS29A2	C8D25DS29B2	C8D25DS29C2	C8D25DS29D2	C8D25DS29E2
28	3.635 92.33	3.375 85.73	3.060 77.72	2.900 73.66	2.700 68.58	C8D28DS29A2	C8D28DS29B2	C8D28DS29C2	C8D28DS29D2	C8D28DS29E2
30	3.835 97.41	3.575 90.81	3.260 82.80	3.100 78.74	2.900 73.66	C8D30DS29A2	C8D30DS29B2	C8D30DS29C2	C8D30DS29D2	C8D30DS29E2
31	3.935 99.95	3.675 93.35	3.360 85.34	3.200 81.28	3.000 76.20	C8D31DS29A2	C8D31DS29B2	C8D31DS29C2	C8D31DS29D2	C8D31DS29E2
35	4.335 110.11	4.075 103.51	3.760 95.50	3.600 91.44	3.400 86.36	C8D35DS29A2	C8D35DS29B2	C8D35DS29C2	C8D35DS29D2	C8D35DS29E2
36	4.435 112.65	4.175 106.05	3.860 98.04	3.700 93.98	3.500 88.90	C8D36DS29A2	C8D36DS29B2	C8D36DS29C2	C8D36DS29D2	C8D36DS29E2
40	4.835 122.81	4.575 116.21	4.260 108.20	4.100 104.14	3.900 99.06	C8D40DS29A2	C8D40DS29B2	C8D40DS29C2	C8D40DS29D2	C8D40DS29E2
43	5.135 130.43	4.875 123.83	4.560 115.82	4.400 111.76	4.200 106.68	C8D43DS29A2	C8D43DS29B2	C8D43DS29C2	C8D43DS29D2	C8D43DS29E2

.100" [2.54] Centerline / .200" [5.08] Row-to-Row

No. of Dual Readout Positions	Dimensions					Mounting Ear Options				
	A	B	C	D	E	Centered Mounting Ear .125" [3.18] Thru Hole	Centered Mounting Ear 4-40 Threaded insert	No Mounting Ears	Flush Mounting Ear .125" [3.18] Thru Hole	Flush Mounting Ear 4-40 Threaded insert
<b>Tail Length .160" [4.06] (DIM "J") (Continued)</b>										
50	5.835 148.21	5.575 141.61	5.260 133.60	5.100 129.54	4.900 124.46	C8D50DS29A2	C8D50DS29B2	C8D50DS29C2	C8D50DS29D2	C8D50DS29E2
60	6.835 173.61	6.575 167.01	6.260 159.00	6.100 154.94	5.900 149.86	C8D60DS29A2	C8D60DS29B2	C8D60DS29C2	C8D60DS29D2	C8D60DS29E2
<b>Tail Length .220" [5.59] (DIM "J")</b>										
6	1.435 36.45	1.175 29.85	0.860 21.84	0.700 17.78	0.500 12.70	C8D06DS29A3	C8D06DS29B3	C8D06DS29C3	C8D06DS29D3	C8D06DS29E3
10	1.835 46.61	1.575 40.01	1.260 32.00	1.100 27.94	0.900 22.86	C8D10DS29A3	C8D10DS29B3	C8D10DS29C3	C8D10DS29D3	C8D10DS29E3
12	2.035 51.69	1.775 45.09	1.460 37.08	1.300 33.02	1.100 27.94	C8D12DS29A3	C8D12DS29B3	C8D12DS29C3	C8D12DS29D3	C8D12DS29E3
15	2.335 59.31	2.075 52.71	1.760 44.70	1.600 40.64	1.400 35.56	C8D15DS29A3	C8D15DS29B3	C8D15DS29C3	C8D15DS29D3	C8D15DS29E3
18	2.635 66.93	2.375 60.33	2.060 52.32	1.900 48.26	1.700 43.18	C8D18DS29A3	C8D18DS29B3	C8D18DS29C3	C8D18DS29D3	C8D18DS29E3
20	2.835 72.01	2.575 65.41	2.260 57.40	2.100 53.34	1.900 48.26	C8D20DS29A3	C8D20DS29B3	C8D20DS29C3	C8D20DS29D3	C8D20DS29E3
22	3.035 77.09	2.775 70.49	2.460 62.48	2.300 58.42	2.100 53.34	C8D22DS29A3	C8D22DS29B3	C8D22DS29C3	C8D22DS29D3	C8D22DS29E3
25	3.335 84.71	3.075 78.11	2.760 70.10	2.600 66.04	2.400 60.96	C8D25DS29A3	C8D25DS29B3	C8D25DS29C3	C8D25DS29D3	C8D25DS29E3
28	3.635 92.33	3.375 85.73	3.060 77.72	2.900 73.66	2.700 68.58	C8D28DS29A3	C8D28DS29B3	C8D28DS29C3	C8D28DS29D3	C8D28DS29E3
30	3.835 97.41	3.575 90.81	3.260 82.80	3.100 78.74	2.900 73.66	C8D30DS29A3	C8D30DS29B3	C8D30DS29C3	C8D30DS29D3	C8D30DS29E3
31	3.935 99.95	3.675 93.35	3.360 85.34	3.200 81.28	3.000 76.20	C8D31DS29A3	C8D31DS29B3	C8D31DS29C3	C8D31DS29D3	C8D31DS29E3
35	4.335 110.11	4.075 103.51	3.760 95.50	3.600 91.44	3.400 86.36	C8D35DS29A3	C8D35DS29B3	C8D35DS29C3	C8D35DS29D3	C8D35DS29E3
36	4.435 112.65	4.175 106.05	3.860 98.04	3.700 93.98	3.500 88.90	C8D36DS29A3	C8D36DS29B3	C8D36DS29C3	C8D36DS29D3	C8D36DS29E3
40	4.835 122.81	4.575 116.21	4.260 108.20	4.100 104.14	3.900 99.06	C8D40DS29A3	C8D40DS29B3	C8D40DS29C3	C8D40DS29D3	C8D40DS29E3
43	5.135 130.43	4.875 123.83	4.560 115.82	4.400 111.76	4.200 106.68	C8D43DS29A3	C8D43DS29B3	C8D43DS29C3	C8D43DS29D3	C8D43DS29E3
50	5.835 148.21	5.575 141.61	5.260 133.60	5.100 129.54	4.900 124.46	C8D50DS29A3	C8D50DS29B3	C8D50DS29C3	C8D50DS29D3	C8D50DS29E3
60	6.835 173.61	6.575 167.01	6.260 159.00	6.100 154.94	5.900 149.86	C8D60DS29A3	C8D60DS29B3	C8D60DS29C3	C8D60DS29D3	C8D60DS29E3

Solder Type Board-to-Board Connectors

**Cantilever Series Connectors 100 x .200 [2.54 x 5.08], .510 [12.95] and .395 [10.03] Card Slot Depth, Full Scoop**

**Product Facts**

- Recognized under the Component Program of Underwriters Laboratories Inc., File No. E60980 
- Certified by Canadian Standards Association, File No. LR49571 

**Physical Properties:**

**Insulation Resistance**—5000 megohms minimum.

**Insertion/Withdrawal Force (Daughter Card)**—8 oz./2 oz. [35.6 N/ 8.9 N] average contact pair using .0620 [1.57] steel blade.

**Insulator Body**—Glass filled thermoplastic, UL rating 94V-0. High temp. plastic option is available; add suffix M399 to part number.

**Color**—Black

**Contacts**—High strength copper alloy.

**Contact Plating**—.000050 [0.00127] nickel underplate with .000030 [0.00076] gold in the mating area, tin/lead on tails, .000100 [0.00254] minimum

**Electrical Properties:**

**Operation Voltage**—600 VDC (sea level)

**Current Rating**—3 Amperes

**Initial Contact Resistance**—10 milliohms

**Environmental Properties:**

**Operating Temperature**—-55°C to +125°C

**Temperature Cycling**—MIL-STD-202 method 107

**Vibration**—MIL-STD-202 method 204

**Related Product Data**

**Daughter Card Edge Pattern**—page 57

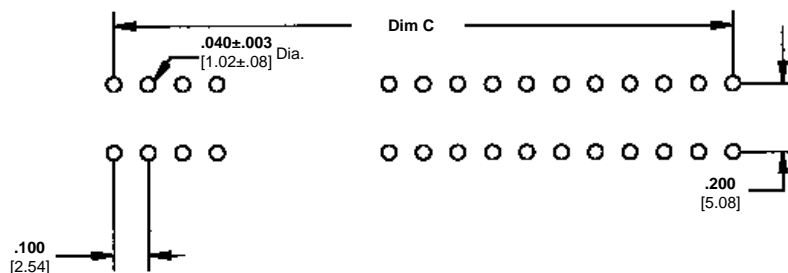
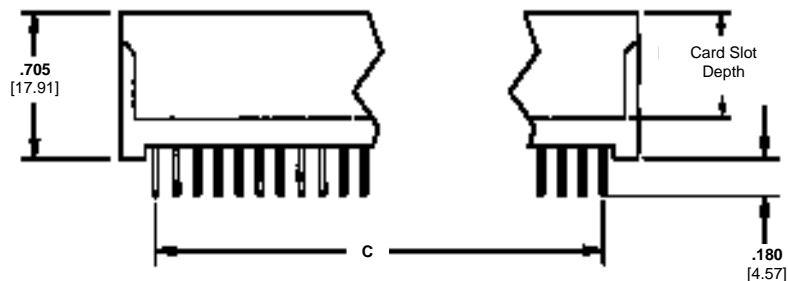
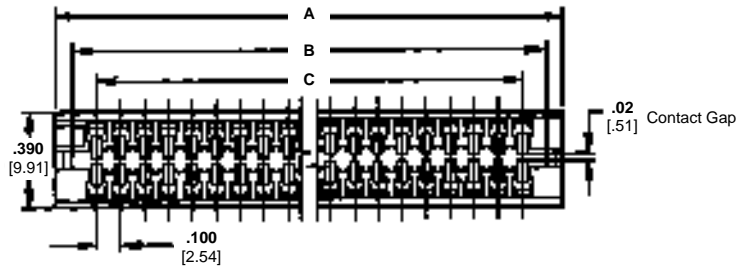
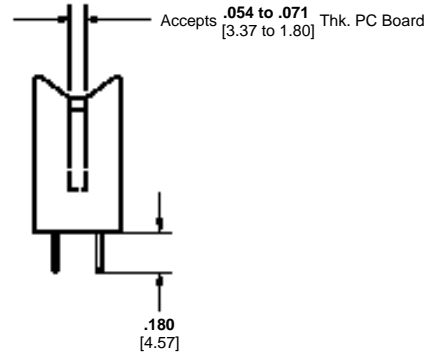

Solder Type Board-to-Board Connectors



**Ordering Information**

.100" [2.54] Centerline / .200" [5.08] Row-to-Row Full Scoop

No. of Dual Readout Pos.	Dimensions			Acquired Part Number
	A	B	C	
<b>.510" [12.95] Card Slot Depth</b>				
18	<b>2.034</b> 51.66	<b>1.904</b> 48.36	<b>1.700</b> 43.18	W8D18DS29063
20	<b>2.234</b> 56.74	<b>2.104</b> 53.44	<b>1.900</b> 48.26	W8D20DS29063
22	<b>2.434</b> 61.82	<b>2.304</b> 58.52	<b>2.100</b> 53.34	W8D22DS29063
25	<b>2.734</b> 69.44	<b>2.604</b> 66.14	<b>2.400</b> 60.96	W8D25DS29063
28	<b>3.034</b> 77.06	<b>2.904</b> 73.76	<b>2.700</b> 68.58	W8D28DS29063
30	<b>3.234</b> 82.14	<b>3.104</b> 78.84	<b>2.900</b> 73.66	W8D30DS29063
35	<b>3.734</b> 94.84	<b>3.604</b> 91.54	<b>3.400</b> 86.36	W8D35DS29063
36	<b>3.834</b> 97.38	<b>3.704</b> 94.08	<b>3.500</b> 88.90	W8D36DS29063
40	<b>4.234</b> 107.54	<b>4.104</b> 104.24	<b>3.900</b> 99.06	W8D40DS29063
43	<b>4.534</b> 115.16	<b>4.404</b> 111.86	<b>4.200</b> 106.68	W8D43DS29063
45	<b>4.734</b> 120.24	<b>4.604</b> 116.94	<b>4.400</b> 111.76	W8D45DS29063
50	<b>5.234</b> 132.94	<b>5.104</b> 129.64	<b>4.900</b> 124.46	W8D50DS29063
60	<b>6.234</b> 158.34	<b>6.104</b> 155.04	<b>5.900</b> 149.86	W8D60DS29063
<b>.395" [10.03] Card Slot Depth</b>				
18	<b>2.034</b> 51.66	<b>1.904</b> 48.36	<b>1.700</b> 43.18	W8D18DS29093
20	<b>2.234</b> 56.74	<b>2.104</b> 53.44	<b>1.900</b> 48.26	W8D20DS29093
22	<b>2.434</b> 61.82	<b>2.304</b> 58.52	<b>2.100</b> 53.34	W8D22DS29093
25	<b>2.734</b> 69.44	<b>2.604</b> 66.14	<b>2.400</b> 60.96	W8D25DS29093
28	<b>3.034</b> 77.06	<b>2.904</b> 73.76	<b>2.700</b> 68.58	W8D28DS29093
30	<b>3.234</b> 82.14	<b>3.104</b> 78.84	<b>2.900</b> 73.66	W8D30DS29093
35	<b>3.734</b> 94.84	<b>3.604</b> 91.54	<b>3.400</b> 86.36	W8D35DS29093
36	<b>3.834</b> 97.38	<b>3.704</b> 94.08	<b>3.500</b> 88.90	W8D36DS29093
40	<b>4.234</b> 107.54	<b>4.104</b> 104.24	<b>3.900</b> 99.06	W8D40DS29093
43	<b>4.534</b> 115.16	<b>4.404</b> 111.86	<b>4.200</b> 106.68	W8D43DS29093
45	<b>4.734</b> 120.24	<b>4.604</b> 116.94	<b>4.400</b> 111.76	W8D45DS29093
50	<b>5.234</b> 132.94	<b>5.104</b> 129.64	<b>4.900</b> 124.46	W8D50DS29093
60	<b>6.234</b> 158.34	<b>6.104</b> 155.04	<b>5.900</b> 149.86	W8D60DS29093

Solder Type Board-to-Board Connectors

**Cantilever Series Connectors .125 x .250 [3.18 x 6.35] Centerline, Dip Solder Tails, .300 [7.62] Card Slot Depth**

**Product Facts**

- Recognized under the Component Program of Underwriters Laboratories Inc., File No. E60980 
- Certified by Canadian Standards Association, File No. LR49571 

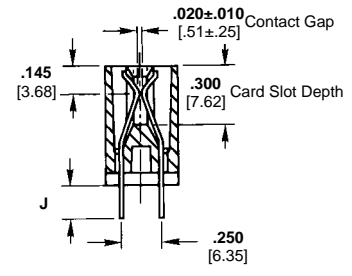

**Physical Properties:**

**Insulation Resistance**—5000 megohms minimum.  
**Insertion/Withdrawal Force (Daughter Card)**—8 oz./2 oz. [35.6 N/ 8.9 N] average contact pair using .0620 [1.57] steel blade.  
**Insulator Body**—Glass filled thermoplastic, UL rating 94V-0. High temp. plastic option is available; add suffix M399 to part number.

**Color**—Black  
**Contacts**—High strength copper alloy.  
**Contact Plating**—.000050 [0.00127] nickel underplate with .000030 [0.00076] gold in the mating area, tin/lead on tails, .000100 [0.00254] minimum

**Electrical Properties:**  
**Operation Voltage**—1000 VDC (sea level)  
**Current Rating**—3 Amperes  
**Initial Contact Resistance**—10 milliohms

**Environmental Properties:**  
**Operating Temperature**—-55°C to +125°C  
**Temperature Cycling**—MIL-STD-202 method 107  
**Vibration**—MIL-STD-202 method 204

**Related Product Data:**  
**Daughter Card Edge Pattern**—page 57

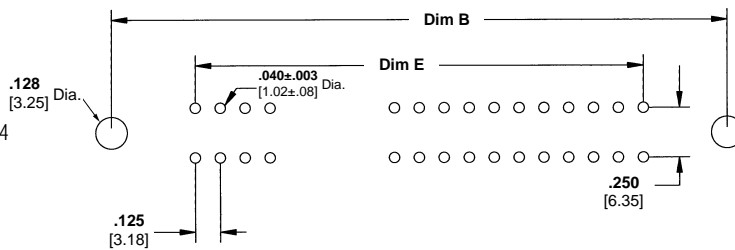
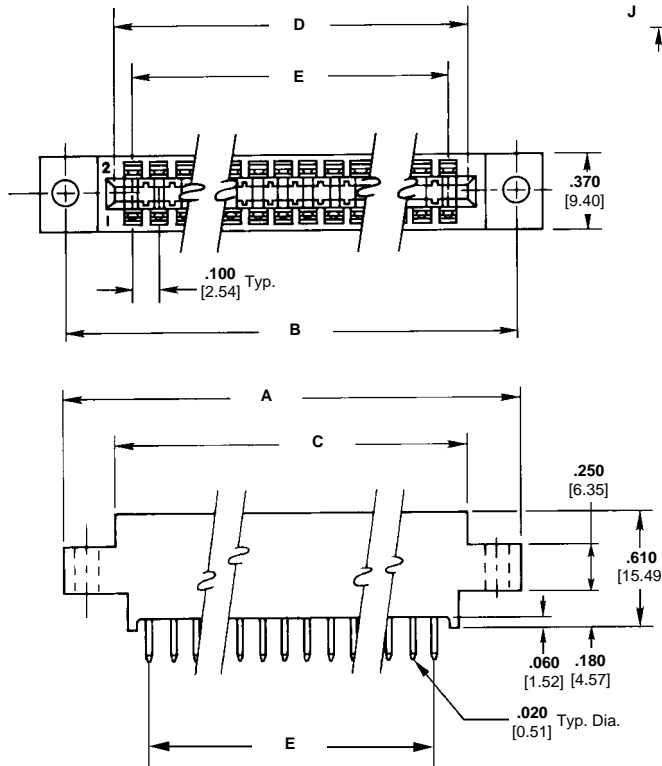

**Mounting Styles**

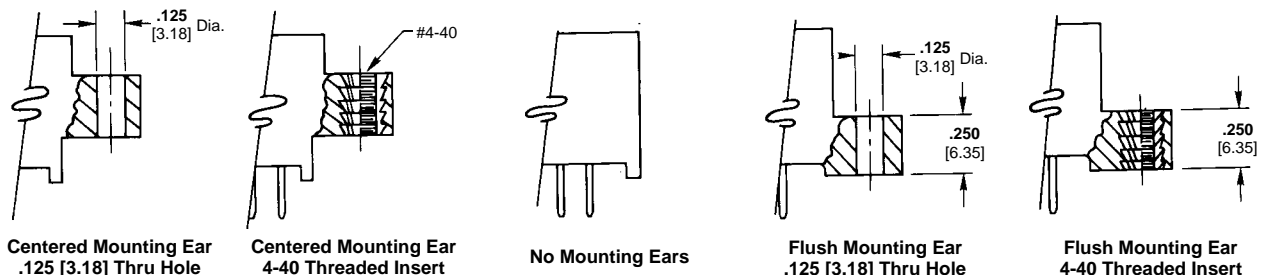

.125" [3.18] Centerline / .250" [6.35] Row-to-Row

No. of Dual Readout Positions	Dimensions					Mounting Ear Options				
	A	B	C	D	E	Centered Mounting Ear .125" [3.18] Thru Hole	Centered Mounting Ear 4-40 Threaded insert	No Mounting Ears	Flush Mounting Ear .125" [3.18] Thru Hole	Flush Mounting Ear 4-40 Threaded insert
<b>Tail Length .130 [3.30] (DIM. "J")</b>										
6	1.555 39.50	1.295 32.89	1.035 26.29	0.875 22.23	0.625 15.88	C7D06DS29A1	C7D06DS29B1	C7D06DS29C1	C7D06DS29D1	C7D06DS29E1
10	2.055 52.20	1.795 45.59	1.535 38.99	1.375 34.93	1.125 28.58	C7D10DS29A1	C7D10DS29B1	C7D10DS29C1	C7D10DS29D1	C7D10DS29E1
15	2.680 68.07	2.420 61.47	2.160 54.86	2.000 50.80	1.750 44.45	C7D15DS29A1	C7D15DS29B1	C7D15DS29C1	C7D15DS29D1	C7D15DS29E1
18	3.055 77.60	2.795 70.99	2.535 64.39	2.375 60.33	2.125 53.98	C7D18DS29A1	C7D18DS29B1	C7D18DS29C1	C7D18DS29D1	C7D18DS29E1
22	3.555 90.30	3.295 83.69	3.035 77.09	2.875 73.03	2.625 66.68	C7D22DS29A1	C7D22DS29B1	C7D22DS29C1	C7D22DS29D1	C7D22DS29E1
25	3.930 99.82	3.670 93.22	3.410 86.61	3.250 82.55	3.000 76.20	C7D25DS29A1	C7D25DS29B1	C7D25DS29C1	C7D25DS29D1	C7D25DS29E1
28	4.305 109.35	4.045 102.74	3.785 96.14	3.625 92.08	3.375 85.73	C7D28DS29A1	C7D28DS29B1	C7D28DS29C1	C7D28DS29D1	C7D28DS29E1
30	4.555 115.70	4.295 109.09	4.035 102.49	3.875 98.43	3.625 92.08	C7D30DS29A1	C7D30DS29B1	C7D30DS29C1	C7D30DS29D1	C7D30DS29E1
31	4.680 118.87	4.420 112.27	4.160 105.66	4.000 101.60	3.750 95.25	C7D31DS29A1	C7D31DS29B1	C7D31DS29C1	C7D31DS29D1	C7D31DS29E1
35	5.180 131.57	4.920 124.97	4.660 118.36	4.500 114.30	4.250 107.95	C7D35DS29A1	C7D35DS29B1	C7D35DS29C1	C7D35DS29D1	C7D35DS29E1
36	5.305 134.75	5.045 128.14	4.785 121.54	4.625 117.48	4.375 111.13	C7D36DS29A1	C7D36DS29B1	C7D36DS29C1	C7D36DS29D1	C7D36DS29E1
40	5.805 147.45	5.545 140.84	5.285 134.24	5.125 130.18	4.875 123.83	C7D40DS29A1	C7D40DS29B1	C7D40DS29C1	C7D40DS29D1	C7D40DS29E1
43	6.180 156.97	5.920 150.37	5.660 143.76	5.500 139.70	5.250 133.35	C7D43DS29A1	C7D43DS29B1	C7D43DS29C1	C7D43DS29D1	C7D43DS29E1
50	7.055 179.20	6.795 172.59	6.535 165.99	6.375 161.93	6.125 155.58	C7D50DS29A1	C7D50DS29B1	C7D50DS29C1	C7D50DS29D1	C7D50DS29E1
<b>Tail Length .160 [4.06] (DIM. "J")</b>										
6	1.555 39.50	1.295 32.89	1.035 26.29	0.875 22.23	0.625 15.88	C7D06DS29A3	C7D06DS29B3	C7D06DS29C3	C7D06DS29D3	C7D06DS29E3
10	2.055 52.20	1.795 45.59	1.535 38.99	1.375 34.93	1.125 28.58	C7D10DS29A3	C7D10DS29B3	C7D10DS29C3	C7D10DS29D3	C7D10DS29E3
15	2.680 68.07	2.420 61.47	2.160 54.86	2.000 50.80	1.750 44.45	C7D15DS29A3	C7D15DS29B3	C7D15DS29C3	C7D15DS29D3	C7D15DS29E3
18	3.055 77.60	2.795 70.99	2.535 64.39	2.375 60.33	2.125 53.98	C7D18DS29A3	C7D18DS29B3	C7D18DS29C3	C7D18DS29D3	C7D18DS29E3
22	3.555 90.30	3.295 83.69	3.035 77.09	2.875 73.03	2.625 66.68	C7D22DS29A3	C7D22DS29B3	C7D22DS29C3	C7D22DS29D3	C7D22DS29E3
25	3.930 99.82	3.670 93.22	3.410 86.61	3.250 82.55	3.000 76.20	C7D25DS29A3	C7D25DS29B3	C7D25DS29C3	C7D25DS29D3	C7D25DS29E3
28	4.305 109.35	4.045 102.74	3.785 96.14	3.625 92.08	3.375 85.73	C7D28DS29A3	C7D28DS29B3	C7D28DS29C3	C7D28DS29D3	C7D28DS29E3
30	4.555 115.70	4.295 109.09	4.035 102.49	3.875 98.43	3.625 92.08	C7D30DS29A3	C7D30DS29B3	C7D30DS29C3	C7D30DS29D3	C7D30DS29E3
31	4.680 118.87	4.420 112.27	4.160 105.66	4.000 101.60	3.750 95.25	C7D31DS29A3	C7D31DS29B3	C7D31DS29C3	C7D31DS29D3	C7D31DS29E3
35	5.180 131.57	4.920 124.97	4.660 118.36	4.500 114.30	4.250 107.95	C7D35DS29A3	C7D35DS29B3	C7D35DS29C3	C7D35DS29D3	C7D35DS29E3
36	5.305 134.75	5.045 128.14	4.785 121.54	4.625 117.48	4.375 111.13	C7D36DS29A3	C7D36DS29B3	C7D36DS29C3	C7D36DS29D3	C7D36DS29E3
40	5.805 147.45	5.545 140.84	5.285 134.24	5.125 130.18	4.875 123.83	C7D40DS29A3	C7D40DS29B3	C7D40DS29C3	C7D40DS29D3	C7D40DS29E3
43	6.180 156.97	5.920 150.37	5.660 143.76	5.500 139.70	5.250 133.35	C7D43DS29A3	C7D43DS29B3	C7D43DS29C3	C7D43DS29D3	C7D43DS29E3
50	7.055 179.20	6.795 172.59	6.535 165.99	6.375 161.93	6.125 155.58	C7D50DS29A3	C7D50DS29B3	C7D50DS29C3	C7D50DS29D3	C7D50DS29E3

Solder Type Board-to-Board Connectors

**Ordering Information**

.125" [3.18] Centerline / .250" [6.35] Row-to-Row

No. of Dual Readout Positions	Dimensions					Mounting Ear Options				
	A	B	C	D	E	Centered Mounting Ear .125" [3.18] Thru Hole	Centered Mounting Ear 4-40 Threaded insert	No Mounting Ears	Flush Mounting Ear .125" [3.18] Thru Hole	Flush Mounting Ear 4-40 Threaded insert
Tail Length .220 [5.59] (DIM. "J")										
6	1.555 39.50	1.295 32.89	1.035 26.29	0.875 22.23	0.625 15.88	C7D06DS29A4	C7D06DS29B4	C7D06DS29C4	C7D06DS29D4	C7D06DS29E4
10	2.055 52.20	1.795 45.59	1.535 38.99	1.375 34.93	1.125 28.58	C7D10DS29A4	C7D10DS29B4	C7D10DS29C4	C7D10DS29D4	C7D10DS29E4
15	2.680 68.07	2.420 61.47	2.160 54.86	2.000 50.80	1.750 44.45	C7D15DS29A4	C7D15DS29B4	C7D15DS29C4	C7D15DS29D4	C7D15DS29E4
18	3.055 77.60	2.795 70.99	2.535 64.39	2.375 60.33	2.125 53.98	C7D18DS29A4	C7D18DS29B4	C7D18DS29C4	C7D18DS29D4	C7D18DS29E4
22	3.555 90.30	3.295 83.69	3.035 77.09	2.875 73.03	2.625 66.68	C7D22DS29A4	C7D22DS29B4	C7D22DS29C4	C7D22DS29D4	C7D22DS29E4
25	3.930 99.82	3.670 93.22	3.410 86.61	3.250 82.55	3.000 76.20	C7D25DS29A4	C7D25DS29B4	C7D25DS29C4	C7D25DS29D4	C7D25DS29E4
28	4.305 109.35	4.045 102.74	3.785 96.14	3.625 92.08	3.375 85.73	C7D28DS29A4	C7D28DS29B4	C7D28DS29C4	C7D28DS29D4	C7D28DS29E4
30	4.555 115.70	4.295 109.09	4.035 102.49	3.875 98.43	3.625 92.08	C7D30DS29A4	C7D30DS29B4	C7D30DS29C4	C7D30DS29D4	C7D30DS29E4
31	4.680 118.87	4.420 112.27	4.160 105.66	4.000 101.60	3.750 95.25	C7D31DS29A4	C7D31DS29B4	C7D31DS29C4	C7D31DS29D4	C7D31DS29E4
35	5.180 131.57	4.920 124.97	4.660 118.36	4.500 114.30	4.250 107.95	C7D35DS29A4	C7D35DS29B4	C7D35DS29C4	C7D35DS29D4	C7D35DS29E4
36	5.305 134.75	5.045 128.14	4.785 121.54	4.625 117.48	4.375 111.13	C7D36DS29A4	C7D36DS29B4	C7D36DS29C4	C7D36DS29D4	C7D36DS29E4
40	5.805 147.45	5.545 140.84	5.285 134.24	5.125 130.18	4.875 123.83	C7D40DS29A4	C7D40DS29B4	C7D40DS29C4	C7D40DS29D4	C7D40DS29E4
43	6.180 156.97	5.920 150.37	5.660 143.76	5.500 139.70	5.250 133.35	C7D43DS29A4	C7D43DS29B4	C7D43DS29C4	C7D43DS29D4	C7D43DS29E4
50	7.055 179.20	6.795 172.59	6.535 166.99	6.375 161.93	6.125 155.58	C7D50DS29A4	C7D50DS29B4	C7D50DS29C4	C7D50DS29D4	C7D50DS29E4

## Cantilever Series .156 x .200 [3.96 x 5.08] Centerline, Dip Solder Tails, .300 [7.62] Card Slot Depth

### Product Facts

- Recognized under the Component Program of Underwriters Laboratories Inc., File No. E60980 
- Certified by Canadian Standards Association, File No. LR49571 

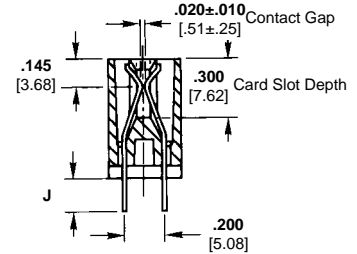

### Physical Properties:

- Insulation Resistance**—5000 megohms minimum.
- Insertion/Withdrawal Force (Daughter Card)**—8 oz./2 oz. [35.6 N/ 8.9 N] average contact pair using .0620 [1.57] steel blade.
- Insulator Body**—Glass filled thermoplastic, UL rating 94V-0. High temp. plastic option is available; add suffix M399 to part number.

- Color**—Black
- Contacts**—High strength copper alloy.
- Contact Plating**—.000050 [0.00127] nickel underplate with .000030 [0.00076] gold in the mating area, tin/lead on tails, .000100 [0.00254] minimum

- Electrical Properties:**
- Operation Voltage**—1500 VDC (sea level)
- Current Rating**—3 Amperes
- Initial Contact Resistance**—10 milliohms

- Environmental Properties:**
- Operating Temperature**—-55°C to +125°C
- Temperature Cycling**—MIL-STD-202 method 107
- Vibration**—MIL-STD-202 method 204

- Related Product Data:**
- Daughter Card Edge Pattern**—page 57

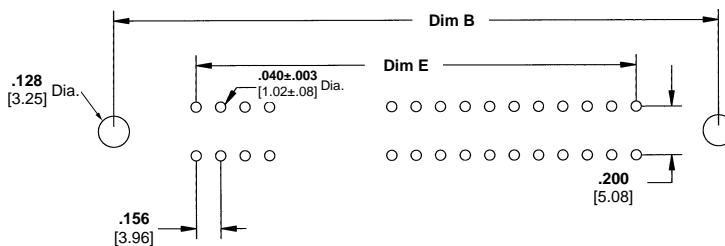
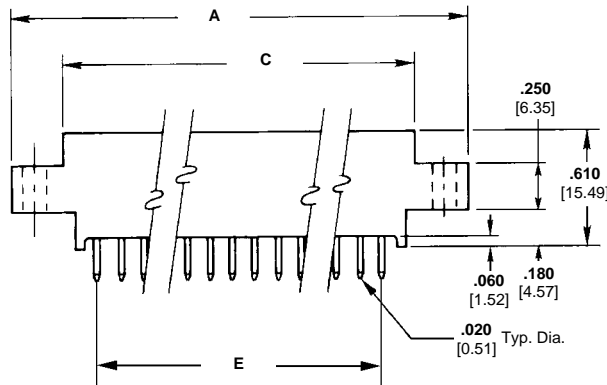
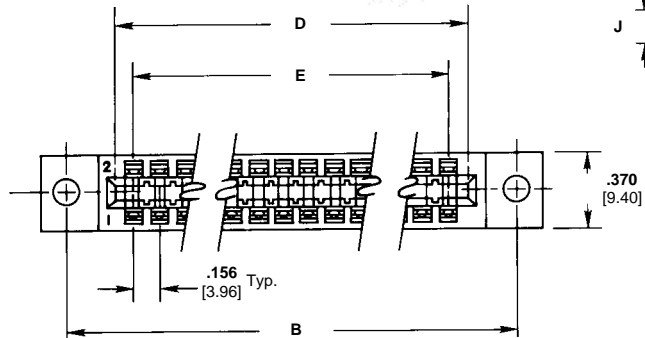

### Mounting Styles

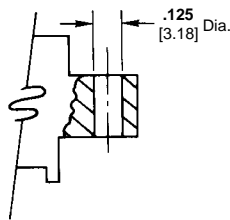

Centered Mounting Ear  
.125 [3.18] Thru Hole

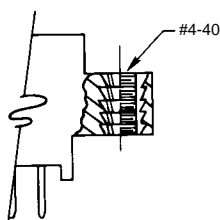

Centered Mounting Ear  
#4-40 Threaded Insert

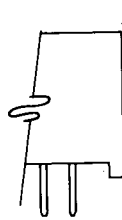

No Mounting Ears

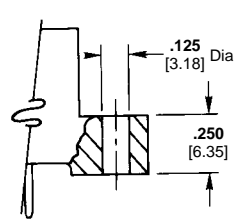

Flush Mounting Ear  
.125 [3.18] Thru Hole

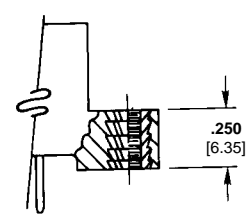

Flush Mounting Ear  
#4-40 Threaded Insert



**Ordering Information**

.156" [3.96] Centerline / .200" [5.08] Row-to-Row

No. of Dual Readout Positions	Dimensions					Mounting Ear Options				
	A	B	C	D	E	Centered Mounting Ear .125" [3.18] Thru Hole	Centered Mounting Ear 4-40 Threaded insert	No Mounting Ears	Flush Mounting Ear .125" [3.18] Thru Hole	Flush Mounting Ear 4-40 Threaded insert
<b>Tail Length .130 [3.30] (DIM. "J")</b>										
6	1.784 45.31	1.534 38.96	1.221 31.01	1.100 27.94	0.780 19.81	C6D06DS29A1	C6D06DS29B1	C6D06DS29C1	C6D06DS29D1	C6D06DS29E1
10	2.408 61.16	2.158 54.81	1.845 46.86	1.724 43.79	1.404 35.66	C6D10DS29A1	C6D10DS29B1	C6D10DS29C1	C6D10DS29D1	C6D10DS29E1
12	2.720 69.09	2.470 62.74	2.157 54.79	2.036 51.71	1.716 43.59	C6D12DS29A1	C6D12DS29B1	C6D12DS29C1	C6D12DS29D1	C6D12DS29E1
15	3.188 80.98	2.938 74.63	2.625 66.68	2.504 63.60	2.184 55.47	C6D15DS29A1	C6D15DS29B1	C6D15DS29C1	C6D15DS29D1	C6D15DS29E1
18	3.656 92.86	3.406 86.51	3.093 78.56	2.972 75.49	2.652 67.36	C6D18DS29A1	C6D18DS29B1	C6D18DS29C1	C6D18DS29D1	C6D18DS29E1
20	3.968 100.79	3.718 94.44	3.405 86.49	3.284 83.41	2.964 75.29	C6D20DS29A1	C6D20DS29B1	C6D20DS29C1	C6D20DS29D1	C6D20DS29E1
22	4.280 108.71	4.030 102.36	3.717 94.41	3.595 91.31	3.276 83.21	C6D22DS29A1	C6D22DS29B1	C6D22DS29C1	C6D22DS29D1	C6D22DS29E1
25	4.748 120.60	4.498 114.25	4.185 106.30	4.064 103.23	3.744 95.10	C6D25DS29A1	C6D25DS29B1	C6D25DS29C1	C6D25DS29D1	C6D25DS29E1
28	5.216 132.49	4.966 126.14	4.653 118.19	4.532 115.11	4.212 106.98	C6D28DS29A1	C6D28DS29B1	C6D28DS29C1	C6D28DS29D1	C6D28DS29E1
30	5.528 140.41	5.278 134.06	4.965 126.11	4.844 123.04	4.524 114.91	C6D30DS29A1	C6D30DS29B1	C6D30DS29C1	C6D30DS29D1	C6D30DS29E1
31	5.684 144.37	5.434 138.02	5.121 130.07	5.000 127.00	4.680 118.87	C6D31DS29A1	C6D31DS29B1	C6D31DS29C1	C6D31DS29D1	C6D31DS29E1
35	6.308 160.22	6.058 153.87	5.745 145.92	5.624 142.85	5.304 134.72	C6D35DS29A1	C6D35DS29B1	C6D35DS29C1	C6D35DS29D1	C6D35DS29E1
36	6.464 164.19	6.214 157.84	5.901 149.89	5.780 146.81	5.460 138.68	C6D36DS29A1	C6D36DS29B1	C6D36DS29C1	C6D36DS29D1	C6D36DS29E1
40	7.088 180.04	6.838 173.69	6.525 165.74	6.404 162.66	6.085 154.56	C6D40DS29A1	C6D40DS29B1	C6D40DS29C1	C6D40DS29D1	C6D40DS29E1
43	7.556 191.92	7.306 185.57	6.993 177.62	6.872 174.55	6.552 166.42	C6D43DS29A1	C6D43DS29B1	C6D43DS29C1	C6D43DS29D1	C6D43DS29E1
50	8.648 219.66	8.398 213.31	8.085 205.36	7.964 202.29	7.644 194.16	C6D50DS29A1	C6D50DS29B1	C6D50DS29C1	C6D50DS29D1	C6D50DS29E1
<b>Tail Length .160 [4.06] (DIM. "J")</b>										
6	1.784 45.31	1.534 38.96	1.221 31.01	1.100 27.94	0.780 19.81	C6D06DS29A3	C6D06DS29B3	C6D06DS29C3	C6D06DS29D3	C6D06DS29E3
10	2.408 61.16	2.158 54.81	1.845 46.86	1.724 43.79	1.404 35.66	C6D10DS29A3	C6D10DS29B3	C6D10DS29C3	C6D10DS29D3	C6D10DS29E3
12	2.720 69.09	2.470 62.74	2.157 54.79	2.036 51.71	1.716 43.59	C6D12DS29A3	C6D12DS29B3	C6D12DS29C3	C6D12DS29D3	C6D12DS29E3
15	3.188 80.98	2.938 74.63	2.625 66.68	2.504 63.60	2.184 55.47	C6D15DS29A3	C6D15DS29B3	C6D15DS29C3	C6D15DS29D3	C6D15DS29E3
18	3.656 92.86	3.406 86.51	3.093 78.56	2.972 75.49	2.652 67.36	C6D18DS29A3	C6D18DS29B3	C6D18DS29C3	C6D18DS29D3	C6D18DS29E3
20	3.968 100.79	3.718 94.44	3.405 86.49	3.284 83.41	2.964 75.29	C6D20DS29A3	C6D20DS29B3	C6D20DS29C3	C6D20DS29D3	C6D20DS29E3
22	4.280 108.71	4.030 102.36	3.717 94.41	3.595 91.31	3.276 83.21	C6D22DS29A3	C6D22DS29B3	C6D22DS29C3	C6D22DS29D3	C6D22DS29E3
25	4.748 120.60	4.498 114.25	4.185 106.30	4.064 103.23	3.744 95.10	C6D25DS29A3	C6D25DS29B3	C6D25DS29C3	C6D25DS29D3	C6D25DS29E3
28	5.216 132.49	4.966 126.14	4.653 118.19	4.532 115.11	4.212 106.98	C6D28DS29A3	C6D28DS29B3	C6D28DS29C3	C6D28DS29D3	C6D28DS29E3
30	5.528 140.41	5.278 134.06	4.965 126.11	4.844 123.04	4.524 114.91	C6D30DS29A3	C6D30DS29B3	C6D30DS29C3	C6D30DS29D3	C6D30DS29E3
31	5.684 144.37	5.434 138.02	5.121 130.07	5.000 127.00	4.680 118.87	C6D31DS29A3	C6D31DS29B3	C6D31DS29C3	C6D31DS29D3	C6D31DS29E3
35	6.308 160.22	6.058 153.87	5.745 145.92	5.624 142.85	5.304 134.72	C6D35DS29A3	C6D35DS29B3	C6D35DS29C3	C6D35DS29D3	C6D35DS29E3
36	6.464 164.19	6.214 157.84	5.901 149.89	5.780 146.81	5.460 138.68	C6D36DS29A3	C6D36DS29B3	C6D36DS29C3	C6D36DS29D3	C6D36DS29E3
40	7.088 180.04	6.838 173.69	6.525 165.74	6.404 162.66	6.085 154.56	C6D40DS29A3	C6D40DS29B3	C6D40DS29C3	C6D40DS29D3	C6D40DS29E3
43	7.556 191.92	7.306 185.57	6.993 177.62	6.872 174.55	6.552 166.42	C6D43DS29A3	C6D43DS29B3	C6D43DS29C3	C6D43DS29D3	C6D43DS29E3
50	8.648 219.66	8.398 213.31	8.085 205.36	7.964 202.29	7.644 194.16	C6D50DS29A3	C6D50DS29B3	C6D50DS29C3	C6D50DS29D3	C6D50DS29E3

Solder Type Board-to-Board Connectors

.156" [3.96] Centerline / .200" [5.08] Row-to-Row

No. of Dual Readout Positions	Dimensions					Mounting Ear Options				
	A	B	C	D	E	Centered Mounting Ear .125" [3.18] Thru Hole	Centered Mounting Ear 4-40 Threaded insert	No Mounting Ears	Flush Mounting Ear .125" [3.18] Thru Hole	Flush Mounting Ear 4-40 Threaded insert
Tail Length .220" [5.59] (DIM. "J")										
6	1.784 45.31	1.534 38.96	1.221 31.01	1.100 27.94	0.780 19.81	C6D06DS29A4	C6D06DS29B4	C6D06DS29C4	C6D06DS29D4	C6D06DS29E4
10	2.408 61.16	2.158 54.81	1.845 46.86	1.724 43.79	1.404 35.66	C6D10DS29A4	C6D10DS29B4	C6D10DS29C4	C6D10DS29D4	C6D10DS29E4
12	2.720 69.09	2.470 62.74	2.157 54.79	2.036 51.71	1.716 43.59	C6D12DS29A4	C6D12DS29B4	C6D12DS29C4	C6D12DS29D4	C6D12DS29E4
15	3.188 80.98	2.938 74.63	2.625 66.68	2.504 63.60	2.184 55.47	C6D15DS29A4	C6D15DS29B4	C6D15DS29C4	C6D15DS29D4	C6D15DS29E4
18	3.656 92.86	3.406 86.51	3.093 78.56	2.972 75.49	2.652 67.36	C6D18DS29A4	C6D18DS29B4	C6D18DS29C4	C6D18DS29D4	C6D18DS29E4
20	3.968 100.79	3.718 94.44	3.405 86.49	3.284 83.41	2.964 75.29	C6D20DS29A4	C6D20DS29B4	C6D20DS29C4	C6D20DS29D4	C6D20DS29E4
22	4.280 108.71	4.030 102.36	3.717 94.41	3.595 91.31	3.276 83.21	C6D22DS29A4	C6D22DS29B4	C6D22DS29C4	C6D22DS29D4	C6D22DS29E4
25	4.748 120.60	4.498 114.25	4.185 106.30	4.064 103.23	3.744 95.10	C6D25DS29A4	C6D25DS29B4	C6D25DS29C4	C6D25DS29D4	C6D25DS29E4
28	5.216 132.49	4.966 126.14	4.653 118.19	4.532 115.11	4.212 106.98	C6D28DS29A4	C6D28DS29B4	C6D28DS29C4	C6D28DS29D4	C6D28DS29E4
30	5.528 140.41	5.278 134.06	4.965 126.11	4.844 123.04	4.524 114.91	C6D30DS29A4	C6D30DS29B4	C6D30DS29C4	C6D30DS29D4	C6D30DS29E4
31	5.684 144.37	5.434 138.02	5.121 130.07	5.000 127.00	4.680 118.87	C6D31DS29A4	C6D31DS29B4	C6D31DS29C4	C6D31DS29D4	C6D31DS29E4
35	6.308 160.22	6.058 153.87	5.745 145.92	5.624 142.85	5.304 134.72	C6D35DS29A4	C6D35DS29B4	C6D35DS29C4	C6D35DS29D4	C6D35DS29E4
36	6.464 164.19	6.214 157.84	5.901 149.89	5.780 146.81	5.460 138.68	C6D36DS29A4	C6D36DS29B4	C6D36DS29C4	C6D36DS29D4	C6D36DS29E4
40	7.088 180.04	6.838 173.69	6.525 165.74	6.404 162.66	6.085 154.56	C6D40DS29A4	C6D40DS29B4	C6D40DS29C4	C6D40DS29D4	C6D40DS29E4
43	7.556 191.92	7.306 185.57	6.993 177.62	6.872 174.55	6.552 166.42	C6D43DS29A4	C6D43DS29B4	C6D43DS29C4	C6D43DS29D4	C6D43DS29E4
50	8.648 219.66	8.398 213.31	8.085 205.36	7.964 202.29	7.644 194.16	C6D50DS29A4	C6D50DS29B4	C6D50DS29C4	C6D50DS29D4	C6D50DS29E4

Solder Type Board-to-Board Connectors

**Modified Bellows Card Edge Connectors****Product Facts**

- Sizes from 6 to 65 dual positions.
- Contact mating surface optimizes reliability by concentrating the normal force in the actual contact area.
- Mounting ear options accommodate both Panel and PC Board attachment.
- Solder stand-offs facilitate cleaning.
- Bifurcated contact design provides redundant points of contact to maximize reliability.
- Tail lengths available to accommodate .062" [1.57] through .125" [3.18] thick PCB Boards and Wire Wrap termination.
- Straight or Right Angle contact configurations.

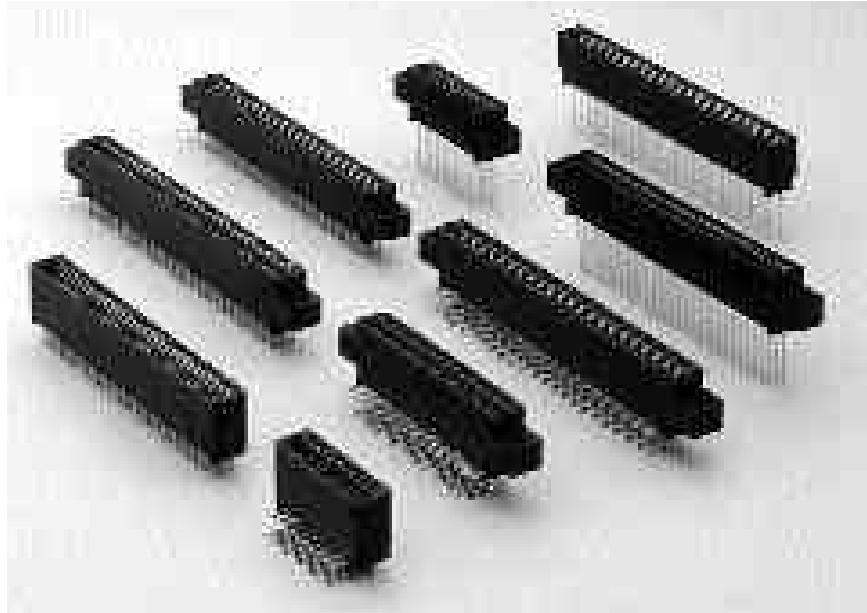

Bifurcated contact design provides maximum reliability

**Description/Application**

The modified bellows card edge connectors are dual readout and are designed for reliable termination to double sided PCB boards.

**Modified Bellows**

The modified bellows card edge connector offers a variety of tail lengths for solder and wire wrap applications. Contacts are available in straight tail or right angle configurations to meet your individual purpose. The modified bellows line of connectors offers a variety of card slot depths and has optional high temperature plastic insulators.

**Modified Bellows Connectors .100 x .200 [2.54 x 5.08], Straight Dip Solder And Wire Wrap Tails**

**Product Facts**

- Recognized under the Component Program of Underwriters Laboratories Inc., File No. E60980 
- Certified by Canadian Standards Association, File No. LR49571 

**Physical Properties:**

**Insulation Resistance**—5000 megohms minimum.

**Insertion/Withdrawal Force (Daughter Card)**—8 oz./2 oz. [35.6 N/ 8.9 N] average contact pair using .0620 [1.57] steel blade.

**Insulator Body**—Glass filled thermoplastic, UL rating 94V-0. High temp. plastic option is available; add suffix M399 to part number.

**Color**—Black

**Contacts**—High strength copper alloy.

**Contact Plating**—.000050 [0.00127] nickel underplate with .000030 [0.00076] gold in the mating area, tin/lead on tails, .000100 [0.00254] minimum

**Electrical Properties:**

**Operation Voltage**—600 VDC (sea level)

**Current Rating**—3 Amperes

**Initial Contact Resistance**—10 milliohms

**Environmental Properties:**

**Operating Temperature**—-55°C to +125°C

**Temperature Cycling**—MIL-STD-202 method 107

**Vibration**—MIL-STD-202 method 204

**Related Product Data:**

**Polarization Key**—page 57

**Daughter Card Edge Pattern**—page 57

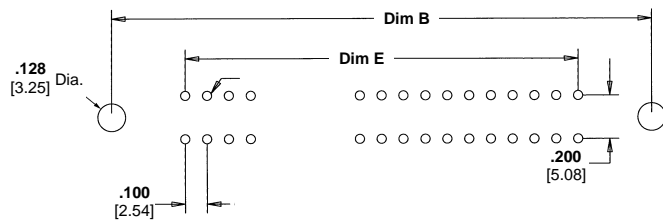
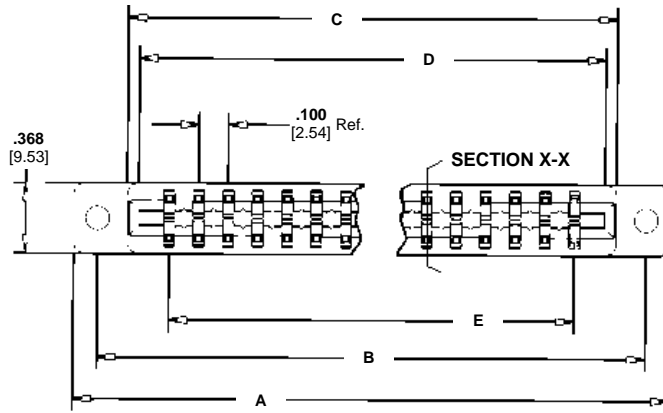
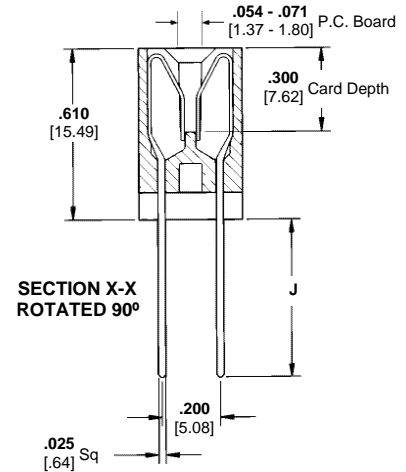
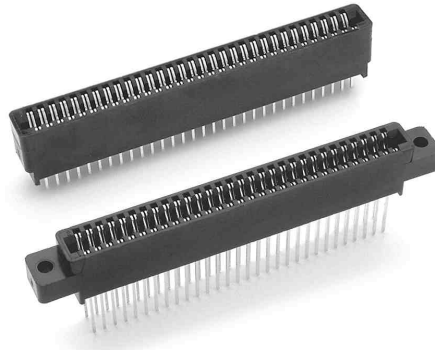

P=.040 [1.02] Dip Solder Applications  
P=.042 [1.07] For Wire Wrap Applications

**Mounting Styles**

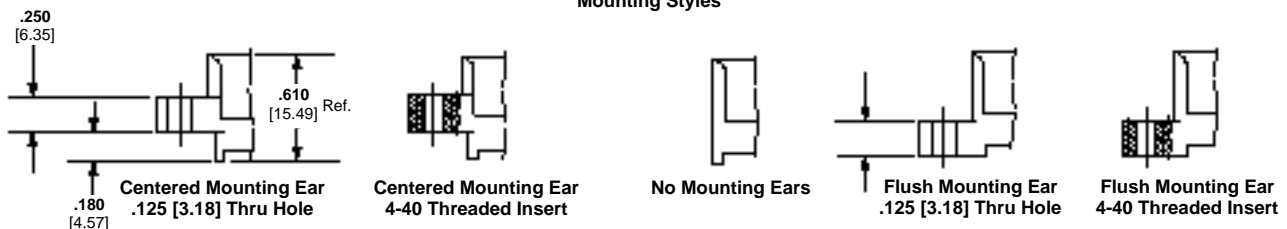

**Ordering Information**

.100" [2.54] Centerline / .200" [5.08] Row-to-Row

No. of Dual Readout Positions	Dimensions					Mounting Ear Options				
	A	B	C	D	E	Centered Mounting Ear .125" [3.18] Thru Hole	Centered Mounting Ear 4-40 Threaded insert	No Mounting Ears	Flush Mounting Ear .125" [3.18] Thru Hole	Flush Mounting Ear 4-40 Threaded insert
<b>Tail Length .160" [4.06] (DIM "J")</b>										
10	1.835 46.61	1.575 40.01	1.260 32.00	1.100 27.94	0.900 22.86	A8D10DS29A2	A8D10DS29B2	A8D10DS29C2	A8D10DS29D2	A8D10DS29E2
12	2.035 51.69	1.775 45.09	1.460 37.08	1.300 33.02	1.100 27.94	A8D12DS29A2	A8D12DS29B2	A8D12DS29C2	—	—
15	2.335 59.31	2.075 52.71	1.760 44.70	1.600 40.64	1.400 35.56	A8D15DS29A2	A8D15DS29B2	A8D15DS29C2	A8D15DS29D2	A8D15DS29E2
18	2.635 66.93	2.375 60.33	2.060 52.32	1.900 48.26	1.700 43.18	A8D18DS29A2	A8D18DS29B2	A8D18DS29C2	A8D18DS29D2	A8D18DS29E2
20	2.835 72.01	2.575 65.41	2.260 57.40	2.100 53.34	1.900 48.26	A8D20DS29A2	A8D20DS29B2	A8D20DS29C2	—	—
22	3.035 77.09	2.775 70.49	2.460 62.48	2.300 58.42	2.100 53.34	A8D22DS29A2	A8D22DS29B2	A8D22DS29C2	—	—
25	3.335 84.71	3.075 78.11	2.760 70.10	2.600 66.04	2.400 60.96	A8D25DS29A2	A8D25DS29B2	A8D25DS29C2	A8D25DS29D2	A8D25DS29E2
28	3.635 92.33	3.375 85.73	3.060 77.72	2.900 73.66	2.700 68.58	A8D28DS29A2	A8D28DS29B2	A8D28DS29C2	—	—
30	3.835 97.41	3.575 90.81	3.260 82.80	3.100 78.74	2.900 73.66	A8D30DS29A2	A8D30DS29B2	A8D30DS29C2	A8D30DS29D2	A8D30DS29E2
31	3.935 99.95	3.675 93.35	3.360 85.34	3.200 81.28	3.100 78.74	A8D31DS29A2	A8D31DS29B2	A8D31DS29C2	A8D31DS29D2	A8D31DS29E2
35	4.335 110.11	4.075 103.51	3.760 95.50	3.600 91.44	3.400 86.36	A8D35DS29A2	A8D35DS29B2	A8D35DS29C2	—	—
36	4.435 112.65	4.175 106.05	3.860 98.04	3.700 93.98	3.500 88.90	A8D36DS29A2	A8D36DS29B2	A8D36DS29C2	—	—
40	4.835 122.81	4.575 116.21	4.260 108.20	4.100 104.14	3.900 99.06	A8D40DS29A2	A8D40DS29B2	A8D40DS29C2	—	—
43	5.135 130.43	4.875 123.83	4.560 115.82	4.400 111.76	4.200 106.68	A8D43DS29A2	A8D43DS29B2	A8D43DS29C2	—	—
44	5.235 132.97	4.975 126.37	4.660 118.36	4.500 114.30	4.300 109.22	A8D44DS29A2	A8D44DS29B2	A8D44DS29C2	—	—
50	5.835 148.21	5.575 141.61	5.260 133.60	5.100 129.54	4.800 121.92	A8D50DS29A2	A8D50DS29B2	A8D50DS29C2	A8D50DS29D2	A8D50DS29E2
60	6.835 173.61	6.575 167.01	6.260 159.00	6.100 154.94	5.900 149.86	A8D60DS29A2	A8D60DS29B2	A8D60DS29C2	—	—
65	7.335 186.31	7.075 179.71	6.760 171.70	6.600 167.64	6.400 162.56	A8D65DS29A2	A8D65DS29B2	A8D65DS29C2	A8D65DS29D2	A8D65DS29E2
<b>Tail Length .220" [5.59] (DIM "J")</b>										
10	1.835 46.61	1.575 40.01	1.260 32.00	1.100 27.94	0.900 22.86	A8D10DS29A3	A8D10DS29B3	A8D10DS29C3	A8D10DS29D3	A8D10DS29E3
12	2.035 51.69	1.775 45.09	1.460 37.08	1.300 33.02	1.100 27.94	A8D12DS29A3	A8D12DS29B3	A8D12DS29C3	—	—
15	2.335 59.31	2.075 52.71	1.760 44.70	1.600 40.64	1.400 35.56	A8D15DS29A3	A8D15DS29B3	A8D15DS29C3	A8D15DS29D3	A8D15DS29E3
18	2.635 66.93	2.375 60.33	2.060 52.32	1.900 48.26	1.700 43.18	A8D18DS29A3	A8D18DS29B3	A8D18DS29C3	A8D18DS29D3	A8D18DS29E3
20	2.835 72.01	2.575 65.41	2.260 57.40	2.100 53.34	1.900 48.26	A8D20DS29A3	A8D20DS29B3	A8D20DS29C3	—	—
22	3.035 77.09	2.775 70.49	2.460 62.48	2.300 58.42	2.100 53.34	A8D22DS29A3	A8D22DS29B3	A8D22DS29C3	—	—
25	3.335 84.71	3.075 78.11	2.760 70.10	2.600 66.04	2.400 60.96	A8D25DS29A3	A8D25DS29B3	A8D25DS29C3	A8D35DS29D3	A8D35DS29E3
28	3.635 92.33	3.375 85.73	3.060 77.72	2.900 73.66	2.700 68.58	A8D28DS29A3	A8D28DS29B3	A8D28DS29C3	—	—
30	3.835 97.41	3.575 90.81	3.260 82.80	3.100 78.74	2.900 73.66	A8D30DS29A3	A8D30DS29B3	A8D30DS29C3	A8D30DS29D3	A8D30DS29E3
31	3.935 99.95	3.675 93.35	3.360 85.34	3.200 81.28	3.100 78.74	A8D31DS29A3	A8D31DS29B3	A8D31DS29C3	A8D31DS29D3	A8D31DS29E3
35	4.335 110.11	4.075 103.51	3.760 95.50	3.600 91.44	3.400 86.36	A8D35DS29A3	A8D35DS29B3	A8D35DS29C3	—	—
36	4.435 112.65	4.175 106.05	3.860 98.04	3.700 93.98	3.500 88.90	A8D36DS29A3	A8D36DS29B3	A8D36DS29C3	—	—
40	4.835 122.81	4.575 116.21	4.260 108.20	4.100 104.14	3.900 99.06	A8D40DS29A3	A8D40DS29B3	A8D40DS29C3	—	—
43	5.135 130.43	4.875 123.83	4.560 115.82	4.400 111.76	4.200 106.68	A8D43DS29A3	A8D43DS29B3	A8D43DS29C3	—	—

Solder Type Board-to-Board Connectors



.100" [2.54] Centerline / .200" [5.08] Row-to-Row

No. of Dual Readout Positions	Dimensions					Mounting Ear Options				
	A	B	C	D	E	Centered Mounting Ear .125" [3.18] Thru Hole	Centered Mounting Ear 4-40 Threaded insert	No Mounting Ears	Flush Mounting Ear .125" [3.18] Thru Hole	Flush Mounting Ear 4-40 Threaded insert
<b>Tail Length .220" [5.59] (DIM "J") (Continued)</b>										
44	5.235 132.97	4.975 126.37	4.660 118.36	4.500 114.30	4.300 109.22	A8D44DS29A3	A8D44DS29B3	A8D44DS29C3	-	-
50	5.835 148.21	5.575 141.61	5.260 133.60	5.100 129.54	4.800 121.92	A8D50DS29A3	A8D50DS29B3	A8D50DS29C3	A8D50DS29D3	A8D50DS29E3
60	6.835 173.61	6.575 167.01	6.260 159.00	6.100 154.94	5.900 149.86	A8D60DS29A3	A8D60DS29B3	A8D60DS29C3	-	-
65	7.335 186.31	7.075 179.71	6.760 171.70	6.600 167.64	6.400 162.56	A8D65DS29A3	A8D65DS29B3	A8D65DS29C3	A8D65DS29D3	A8D65DS29E3
<b>Tail Length .560" [14.22] (DIM "J") for Wire Wrap Termination</b>										
10	1.835 46.61	1.575 40.01	1.260 32.00	1.100 27.94	0.900 22.86	A8D10WW29A3	A8D10WW29B3	-	-	-
12	2.035 51.69	1.775 45.09	1.460 37.08	1.300 33.02	1.100 27.94	A8D12WW29A3	A8D12WW29B3	-	-	-
15	2.335 59.31	2.075 52.71	1.760 44.70	1.600 40.64	1.400 35.56	A8D15WW29A3	A8D15WW29B3	-	-	-
18	2.635 66.93	2.375 60.33	2.060 52.32	1.900 48.26	1.700 43.18	A8D18WW29A3	A8D18WW29B3	-	-	-
20	2.835 72.01	2.575 65.41	2.260 57.40	2.100 53.34	1.900 48.26	A8D20WW29A3	A8D20WW29B3	-	-	-
22	3.035 77.09	2.775 70.49	2.460 62.48	2.300 58.42	2.100 53.34	A8D22WW29A3	A8D22WW29B3	-	-	-
25	3.335 84.71	3.075 78.11	2.760 70.10	2.600 66.04	2.400 60.96	A8D25WW29A3	A8D25WW29B3	-	-	-
28	3.635 92.33	3.375 85.73	3.060 77.72	2.900 73.66	2.700 68.58	A8D28WW29A3	A8D28WW29B3	-	-	-
30	3.835 97.41	3.575 90.81	3.260 82.80	3.100 78.74	2.900 73.66	A8D30WW29A3	A8D30WW29B3	-	-	-
31	3.935 99.95	3.675 93.35	3.360 85.34	3.200 81.28	3.100 78.74	A8D31WW29A3	A8D31WW29B3	-	-	-
35	4.335 110.11	4.075 103.51	3.760 95.50	3.600 91.44	3.400 86.36	A8D35WW29A3	A8D35WW29B3	-	-	-
36	4.435 112.65	4.175 106.05	3.860 98.04	3.700 93.98	3.500 88.90	A8D36WW29A3	A8D36WW29B3	-	-	-
40	4.835 122.81	4.575 116.21	4.260 108.20	4.100 104.14	3.900 99.06	A8D40WW29A3	A8D40WW29B3	-	-	-
43	5.135 130.43	4.875 123.83	4.560 115.82	4.400 111.76	4.200 106.68	A8D43WW29A3	A8D43WW29B3	-	-	-
44	5.235 132.97	4.975 126.37	4.660 118.36	4.500 114.30	4.300 109.22	A8D44WW29A3	A8D44WW29B3	-	-	-
50	5.835 148.21	5.575 141.61	5.260 133.60	5.100 129.54	4.800 121.92	A8D50WW29A3	A8D50WW29B3	-	-	-
60	6.835 173.61	6.575 167.01	6.260 159.00	6.100 154.94	5.900 149.86	A8D60WW29A3	A8D60WW29B3	-	-	-
65	7.335 186.31	7.075 179.71	6.760 171.70	6.600 167.64	6.400 162.56	A8D65WW29A3	A8D65WW29B3	-	-	-

Solder Type Board-to-Board Connectors

**Modified Bellows Connectors .100 x .200 [2.54 x 5.08] and  
.100 x .150 [2.54 x 3.81] Right Angle Dip Solder Tails**

**Product Facts**

- **Recognized under the Component Program of Underwriters Laboratories Inc., File No. E60980** 
- **Certified by Canadian Standards Association, File No. LR49571** 

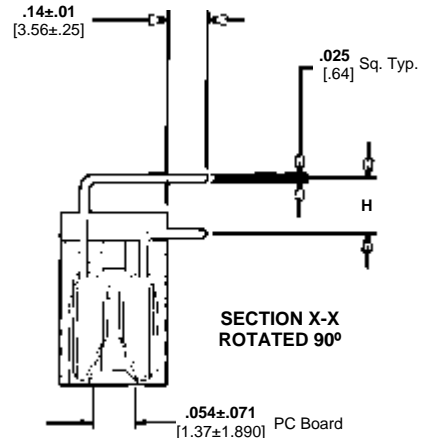

**Physical Properties:**

- Insulation Resistance**—5000 megohms minimum.
- Insertion/Withdrawal Force (Daughter Card)**—8 oz./2 oz. [35.6 N/ 8.9 N] average contact pair using .0620 [1.57] steel blade.
- Insulator Body**—Glass filled thermoplastic, UL rating 94V-0. High temp. plastic option is available; add suffix M399 to part number.
- Color**—Black
- Contacts**—High strength copper alloy.
- Contact Plating**—.000050 [0.00127] nickel underplate with .000030 [0.00076] gold in the mating area, tin/lead on tails, .000100 [0.00254] minimum

**Electrical Properties:**

- Operation Voltage**—600 VDC (sea level)
- Current Rating**—3 Amperes
- Initial Contact Resistance**—10 milliohms

**Environmental Properties:**

- Operating Temperature**—-55°C to +125°C
- Temperature Cycling**—MIL-STD-202 method 107
- Vibration**—MIL-STD-202 method 204

**Related Product Data:**

- Polarization Key**—page 57
- Daughter Card Edge Pattern**—page 57

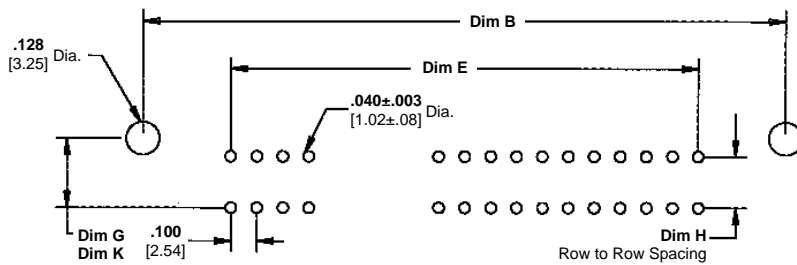
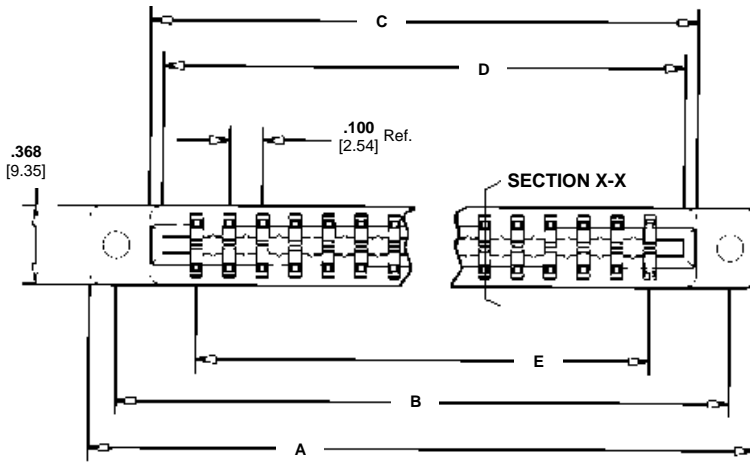

Dim G - Centered Mounting Ear .125 [3.18] Cross Drilled Hole Only  
Dim K - Flush Mounting Ear .125 [3.18] Cross Drilled Hole Only

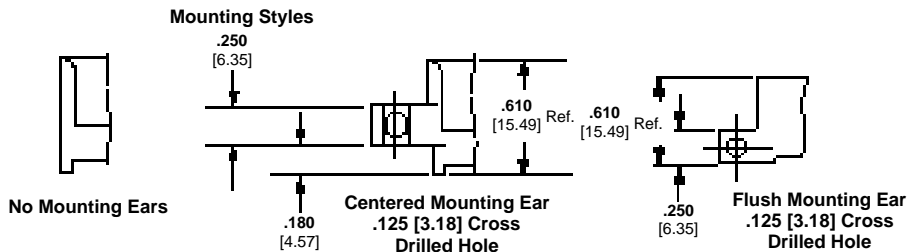
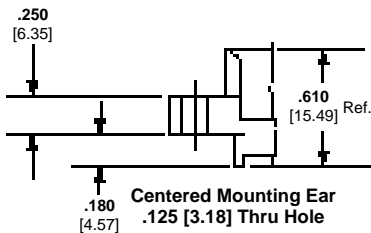

.100" [2.54] Centerline / .200" [5.08] Row-to-Row (Dim. "H") Spacing

No. of Dual Readout Positions	Dimensions					Centered Mounting Ear Only G	Flush Mounting Ear Only K	Centered Mounting Ear .125" [3.18] Thru Hole	Mounting Ear Options		
	A	B	C	D	E				No Mounting Ears	Centered Mounting Ear .125" [3.18] Cross-Drilled Hole	Flush Mounting Ear .125" [3.18] Cross-Drilled Hole
10	1.835 46.61	1.575 40.01	1.260 32.00	1.100 27.94	0.900 22.86	0.470 11.94	0.290 7.37	A8D10RA29A	A8D10RA29C	A8D10RA29E	A8D10RA29F
12	2.035 51.69	1.775 45.09	1.460 37.08	1.300 33.02	1.100 27.94	0.470 11.94	0.290 7.37	A8D12RA29A	A8D12RA29C	A8D12RA29E	-
15	2.335 59.31	2.075 52.71	1.760 44.70	1.600 40.64	1.400 35.56	0.470 11.94	0.290 7.37	A8D15RA29A	A8D15RA29C	A8D15RA29E	A8D15RA29F
18	2.635 66.93	2.375 60.33	2.060 52.32	1.900 48.26	1.700 43.18	0.470 11.94	0.290 7.37	A8D18RA29A	A8D18RA29C	A8D18RA29E	A8D18RA29F
20	2.835 72.01	2.575 65.41	2.260 57.40	2.100 53.34	1.900 48.26	0.470 11.94	0.290 7.37	A8D20RA29A	A8D20RA29C	A8D20RA29E	-
22	3.035 77.09	2.775 70.49	2.460 62.48	2.300 58.42	2.100 53.34	0.470 11.94	0.290 7.37	A8D22RA29A	A8D22RA29C	A8D22RA29E	-
25	3.335 84.71	3.075 78.11	2.760 70.10	2.600 66.04	2.400 60.96	0.470 11.94	0.290 7.37	A8D25RA29A	A8D25RA29C	A8D25RA29E	A8D25RA29F
28	3.635 92.33	3.375 85.73	3.060 77.72	2.900 73.66	2.700 68.58	0.470 11.94	0.290 7.37	A8D28RA29A	A8D28RA29C	A8D28RA29E	-
30	3.835 97.41	3.575 90.81	3.260 82.80	3.100 78.74	2.900 73.66	0.470 11.94	0.290 7.37	A8D30RA29A	A8D30RA29C	A8D30RA29E	A8D30RA29F
31	3.935 99.95	3.675 93.35	3.360 85.34	3.200 81.28	3.100 78.74	0.470 11.94	0.290 7.37	A8D31RA29A	A8D31RA29C	A8D31RA29E	A8D31RA29F
35	4.335 110.11	4.075 103.51	3.760 95.50	3.600 91.44	3.400 86.36	0.470 11.94	0.290 7.37	A8D35RA29A	A8D35RA29C	A8D35RA29E	-
36	4.435 112.65	4.175 106.05	3.860 98.04	3.700 93.98	3.500 88.90	0.470 11.94	0.290 7.37	A8D36RA29A	A8D36RA29C	A8D36RA29E	-
40	4.835 122.81	4.575 116.21	4.260 108.20	4.100 104.14	3.900 99.06	0.470 11.94	0.290 7.37	A8D40RA29A	A8D40RA29C	A8D40RA29E	-
43	5.135 130.43	4.875 123.83	4.560 115.82	4.400 111.76	4.200 106.68	0.470 11.94	0.290 7.37	A8D43RA29A	A8D43RA29C	A8D43RA29E	-
44	5.235 132.97	4.975 126.37	4.660 118.36	4.500 114.30	4.300 109.22	0.470 11.94	0.290 7.37	A8D44RA29A	A8D44RA29C	A8D44RA29E	-
50	5.835 148.21	5.575 141.61	5.260 133.60	5.100 129.54	4.800 121.92	0.470 11.94	0.290 7.37	A8D50RA29A	A8D50RA29C	A8D50RA29E	A8D50RA29F
60	6.835 173.61	6.575 167.01	6.260 159.00	6.100 154.94	5.900 149.86	0.470 11.94	0.290 7.37	A8D60RA29A	A8D60RA29C	A8D60RA29E	-
65	7.335 186.31	7.075 179.71	6.760 171.70	6.600 167.64	6.400 162.56	0.470 11.94	0.290 7.37	A8D65RA29A	A8D65RA29C	A8D65RA29E	A8D65RA29F

Solder Type Board-to-Board Connectors

**Ordering Information**

.100" [2.54] Centerline / .150" [3.81] Row-to-Row (Dim. "H") Spacing

No. of Dual Readout Positions	Dimensions					Mounting Ear Options						
	A	B	C	D	E	Centered Mounting Ear Only G	Flush Mounting Ear Only K	Centered Mounting Ear .125" [3.18] Thru Hole	No Mounting Ears	Centered Mounting Ear .125" [3.18] Cross-Drilled Hole	Flush Mounting Ear .125" [3.18] Cross-Drilled Hole	
10	1.835 46.61	1.575 40.01	1.260 32.00	1.100 27.94	0.900 22.86	0.420 10.67	0.240 6.10	A8D10RA29AM233	A8D10RA29CM233	A8D10RA29EM233	A8D10RA29FM233	
12	2.035 51.69	1.775 45.09	1.460 37.08	1.300 33.02	1.100 27.94	0.420 10.67	0.240 6.10	A8D12RA29AM233	A8D12RA29CM233	A8D12RA29EM233	-	
15	2.335 59.31	2.075 52.71	1.760 44.70	1.600 40.64	1.400 35.56	0.420 10.67	0.240 6.10	A8D15RA29AM233	A8D15RA29CM233	A8D15RA29EM233	A8D15RA29FM233	
18	2.635 66.93	2.375 60.33	2.060 52.32	1.900 48.26	1.700 43.18	0.420 10.67	0.240 6.10	A8D18RA29AM233	A8D18RA29CM233	A8D18RA29EM233	A8D18RA29FM233	
20	2.835 72.01	2.575 65.41	2.260 57.40	2.100 53.34	1.900 48.26	0.420 10.67	0.240 6.10	A8D20RA29AM233	A8D20RA29CM233	A8D20RA29EM233	-	
22	3.035 77.09	2.775 70.49	2.460 62.48	2.300 58.42	2.100 53.34	0.420 10.67	0.240 6.10	A8D22RA29AM233	A8D22RA29CM233	A8D22RA29EM233	-	
25	3.335 84.71	3.075 78.11	2.760 70.10	2.600 66.04	2.400 60.96	0.420 10.67	0.240 6.10	A8D25RA29AM233	A8D25RA29CM233	A8D25RA29EM233	A8D25RA29FM233	
28	3.635 92.33	3.375 85.73	3.060 77.72	2.900 73.66	2.700 68.58	0.420 10.67	0.240 6.10	A8D28RA29AM233	A8D28RA29CM233	A8D28RA29EM233	-	
30	3.835 97.41	3.575 90.81	3.260 82.80	3.100 78.74	2.900 73.66	0.420 10.67	0.240 6.10	A8D30RA29AM233	A8D30RA29CM233	A8D30RA29EM233	A8D30RA29FM233	
31	3.935 99.95	3.675 93.35	3.360 85.34	3.200 81.28	3.100 78.74	0.420 10.67	0.240 6.10	A8D31RA29AM233	A8D31RA29CM233	A8D31RA29EM233	A8D31RA29FM233	
35	4.335 110.11	4.075 103.51	3.760 95.50	3.600 91.44	3.400 86.36	0.420 10.67	0.240 6.10	A8D35RA29AM233	A8D35RA29CM233	A8D35RA29EM233	-	
36	4.435 112.65	4.175 106.05	3.860 98.04	3.700 93.98	3.500 88.90	0.420 10.67	0.240 6.10	A8D36RA29AM233	A8D36RA29CM233	A8D36RA29EM233	-	
40	4.835 122.81	4.575 116.21	4.260 108.20	4.100 104.14	3.900 99.06	0.420 10.67	0.240 6.10	A8D40RA29AM233	A8D40RA29CM233	A8D40RA29EM233	-	
43	5.135 130.43	4.875 123.83	4.560 115.82	4.400 111.76	4.200 106.68	0.420 10.67	0.240 6.10	A8D43RA29AM233	A8D43RA29CM233	A8D43RA29EM233	-	
44	5.235 132.97	4.975 126.37	4.660 118.36	4.500 114.30	4.300 109.22	0.420 10.67	0.240 6.10	A8D44RA29AM233	A8D44RA29CM233	A8D44RA29EM233	-	
50	5.835 148.21	5.575 141.61	5.260 133.60	5.100 129.54	4.800 121.92	0.420 10.67	0.240 6.10	A8D50RA29AM233	A8D50RA29CM233	A8D50RA29EM233	A8D50RA29FM233	
60	6.835 173.61	6.575 167.01	6.260 159.00	6.100 154.94	5.900 149.86	0.420 10.67	0.240 6.10	A8D60RA29AM233	A8D60RA29CM233	A8D60RA29EM233	-	
65	7.335 186.31	7.075 179.71	6.760 171.70	6.600 167.64	6.400 162.56	0.420 10.67	0.240 6.10	A8D65RA29AM233	A8D65RA29CM233	A8D65RA29EM233	A8D65RA29FM233	

Solder Type Board-to-Board Connectors

*Electronics*

**Product Facts**

- Recognized under the Component Program of Underwriters Laboratories Inc., File No. E60980 
- Certified by Canadian Standards Association, File No. LR49571 

**Physical Properties:**

**Insulation Resistance**—5000 megohms minimum.

**Insertion/Withdrawal Force (Daughter Card)**—8 oz./2 oz. [35.6 N/ 8.9 N] average contact pair using .0620 [1.57] steel blade.

**Insulator Body**—Glass filled thermoplastic, UL rating 94V-0. High temp. plastic option is available; add suffix M399 to part number.

**Color**—Black

**Contacts**—High strength copper alloy.

**Contact Plating**—.000050 [0.00127] nickel underplate with .000030 [0.00076] gold in the mating area, tin/lead on tails, .000100 [0.00254] minimum

**Electrical Properties:**

**Operation Voltage**—600 VDC (sea level)

**Current Rating**—3 Amperes

**Initial Contact Resistance**—10 milliohms

**Environmental Properties:**

**Operating Temperature**—-55°C to +125°C

**Temperature Cycling**—MIL-STD-202 method 107

**Vibration**—MIL-STD-202 method 204

**Related Product Data:**

**Polarization Key**—page 57

**Daughter Card Edge Pattern**—page 57

**Modified Bellows Connectors .125 x .250 [3.18 x 6.35], Centerline Straight Dip Solder and Wire Wrap Tails**

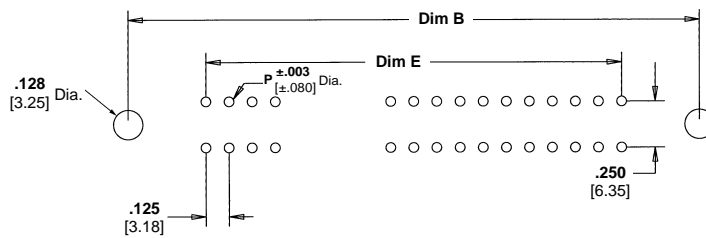
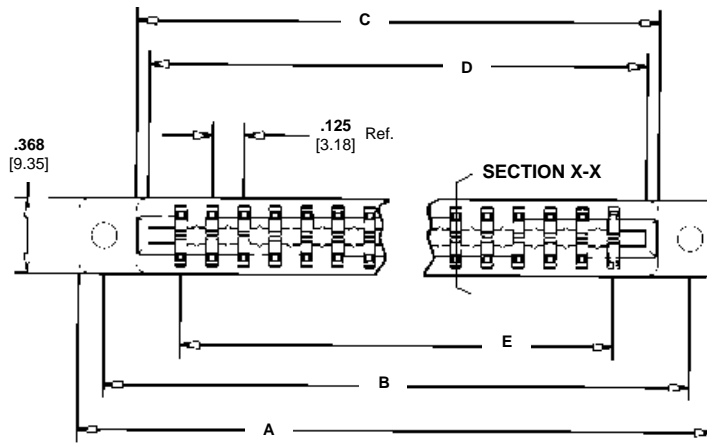
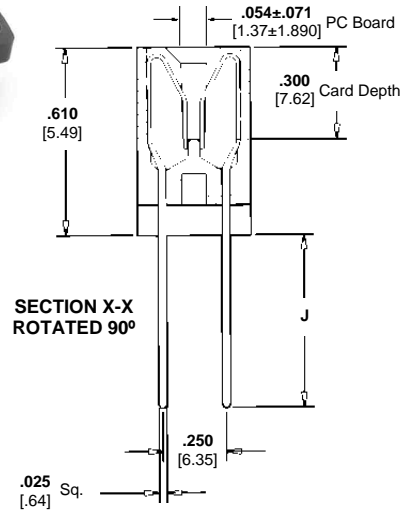
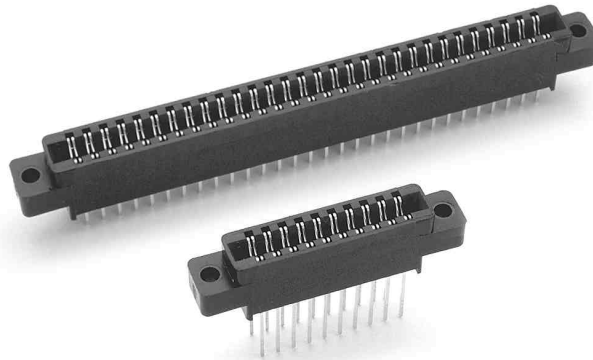

P=.040 [1.02] Dip Solder Applications  
P=.042 [1.07] For Wire Wrap Applications

**Mounting Styles**

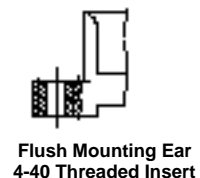
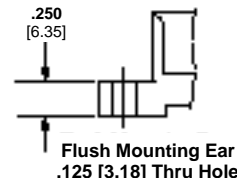
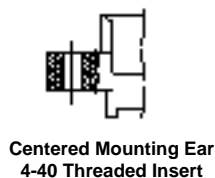
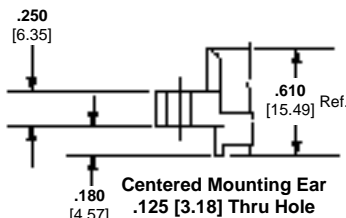



.125" [3.18] Centerline / .250" [6.35] Row-to-Row Dip Solder

No. of Dual Readout Positions	Dimensions					Mounting Ear Options				
	A	B	C	D	E	Centered Mounting Ear .125" [3.18] Thru Hole	Centered Mounting Ear 4-40 Threaded insert	No Mounting Ears	Flush Mounting Ear .125" [3.18] Thru Hole	Flush Mounting Ear 4-40 Threaded insert
<b>Tail Length .160" [4.06] (DIM "J")</b>										
6	1.555 39.50	1.295 32.89	1.035 26.29	0.875 22.23	0.625 15.88	A7D06DS29A2	A7D06DS29B2	A7D06DS29C2	A7D06DS29D2	A7D06DS29E2
10	2.055 52.20	1.795 45.59	1.535 38.99	1.375 34.93	1.125 28.58	A7D10DS29A2	A7D10DS29B2	A7D10DS29C2	A7D10DS29D2	A7D10DS29E2
15	2.680 68.07	2.420 61.47	2.160 54.86	2.000 50.80	1.750 44.45	A7D15DS29A2	A7D15DS29B2	A7D15DS29C2	A7D15DS29D2	A7D15DS29E2
18	3.055 77.60	2.795 70.99	2.535 64.39	2.375 60.33	2.125 53.98	A7D18DS29A2	A7D18DS29B2	A7D18DS29C2	A7D18DS29D2	A7D18DS29E2
22	3.555 90.30	3.295 83.69	3.035 77.09	2.875 73.03	2.625 66.68	A7D22DS29A2	A7D22DS29B2	A7D22DS29C2	-	-
25	3.930 99.82	3.670 93.22	3.410 86.61	3.250 82.55	3.000 76.20	A7D25DS29A2	A7D25DS29B2	A7D25DS29C2	A7D25DS29D2	A7D25DS29E2
28	4.305 109.35	4.045 102.74	3.785 96.14	3.625 92.08	3.375 85.73	A7D28DS29A2	A7D28DS29B2	A7D28DS29C2	-	-
30	4.555 115.70	4.295 109.09	4.035 102.49	3.875 98.43	3.625 92.08	A7D30DS29A2	A7D30DS29B2	A7D30DS29C2	A7D30DS29D2	A7D30DS29E2
35	5.180 131.57	4.920 124.97	4.660 118.36	4.500 114.30	4.250 107.95	A7D35DS29A2	A7D35DS29B2	A7D35DS29C2	-	-
36	5.305 134.75	5.045 128.14	4.785 121.54	4.625 117.48	4.375 111.13	A7D36DS29A2	A7D36DS29B2	A7D36DS29C2	-	-
40	5.805 147.45	5.545 140.84	5.285 134.24	5.125 130.18	4.875 123.83	A7D40DS29A2	A7D40DS29B2	A7D40DS29C2	-	-
43	6.180 156.97	5.920 150.37	5.660 143.76	5.500 139.70	5.250 133.35	A7D43DS29A2	A7D43DS29B2	A7D43DS29C2	-	-
50	7.055 179.20	6.795 172.59	6.535 165.99	6.375 161.93	6.125 155.58	A7D50DS29A2	A7D50DS29B2	A7D50DS29C2	A7D50DS29D2	A7D50DS29E2

.125" [3.18] Centerline / .250" [6.35] Row-to-Row Wire Wrap

No. of Dual Readout Positions	Dimensions					Mounting Ear Options				
	A	B	C	D	E	Centered Mounting Ear .125" [3.18] Thru Hole	Centered Mounting Ear 4-40 Threaded insert	No Mounting Ears	Flush Mounting Ear .125" [3.18] Thru Hole	Flush Mounting Ear 4-40 Threaded insert
<b>Tail Length .560" [14.22] (DIM "J")</b>										
6	1.555 39.50	1.295 32.89	1.035 26.29	0.875 22.23	0.625 15.88	A7D06WW29A3	A7D06WW29B3	-	-	-
10	2.055 52.20	1.795 45.59	1.535 38.99	1.375 34.93	1.125 28.58	A7D10WW29A3	A7D10WW29B3	-	-	-
15	2.680 68.07	2.420 61.47	2.160 54.86	2.000 50.80	1.750 44.45	A7D15WW29A3	A7D15WW29B3	-	-	-
18	3.055 77.60	2.795 70.99	2.535 64.39	2.375 60.33	2.125 53.98	A7D18WW29A3	A7D18WW29B3	-	-	-
22	3.555 90.30	3.295 83.69	3.035 77.09	2.875 73.03	2.625 66.68	A7D22WW29A3	A7D22WW29B3	-	-	-
25	3.930 99.82	3.670 93.22	3.410 86.61	3.250 82.55	3.000 76.20	A7D25WW29A3	A7D25WW29B3	-	-	-
28	4.305 109.35	4.045 102.74	3.785 96.14	3.625 92.08	3.375 85.73	A7D28WW29A3	A7D28WW29B3	-	-	-
30	4.555 115.70	4.295 109.09	4.035 102.49	3.875 98.43	3.625 92.08	A7D30WW29A3	A7D30WW29B3	-	-	-
35	5.180 131.57	4.920 124.97	4.660 118.36	4.500 114.30	4.250 107.95	A7D35WW29A3	A7D35WW29B3	-	-	-
36	5.305 134.75	5.045 128.14	4.785 121.54	4.625 117.48	4.375 111.13	A7D36WW29A3	A7D36WW29B3	-	-	-
40	5.805 147.45	5.545 140.84	5.285 134.24	5.125 130.18	4.875 123.83	A7D40WW29A3	A7D40WW29B3	-	-	-
43	6.180 156.97	5.920 150.37	5.660 143.76	5.500 139.70	5.250 133.35	A7D43WW29A3	A7D43WW29B3	-	-	-
50	7.055 179.20	6.795 172.59	6.535 165.99	6.375 161.93	6.125 155.58	A7D50WW29A3	A7D50WW29B3	-	-	-

Electronics

**Modified Bellows Connectors .125 x .250 [3.18 x 6.35], .125 x .150 [3.18 x 3.81], .125 x .200 [3.18 x 5.08] Centerline, Right Angle Tails**

**Product Facts**

- Recognized under the Component Program of Underwriters Laboratories Inc., File No. E60980 
- Certified by Canadian Standards Association, File No. LR49571 

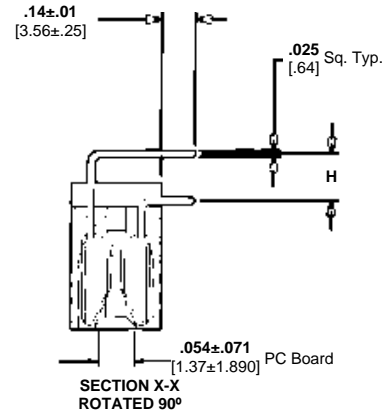

**Physical Properties:**

**Insulation Resistance**—5000 megohms minimum.

**Insertion/Withdrawal Force (Daughter Card)**—8 oz./2 oz. [35.6 N/ 8.9 N] average contact pair using .0620 [1.57] steel blade.

**Insulator Body**—Glass filled thermoplastic, UL rating 94V-0. High temp. plastic option is available; add suffix M399 to part number.

**Color**—Black

**Contacts**—High strength copper alloy.

**Contact Plating**—.000050 [0.00127] nickel underplate with .000030 [0.00076] gold in the mating area, tin/lead on tails, .000100 [0.00254] minimum

**Electrical Properties:**

**Operation Voltage**—1000 VDC (sea level)

**Current Rating**—3 Amperes

**Initial Contact Resistance**—10 milliohms

**Environmental Properties:**

**Operating Temperature**—-55°C to +125°C

**Temperature Cycling**—MIL-STD-202 method 107

**Vibration**—MIL-STD-202 method 204

**Related Product Data:**

**Polarization Key**—page 57

**Daughter Card Edge Pattern**—page 57

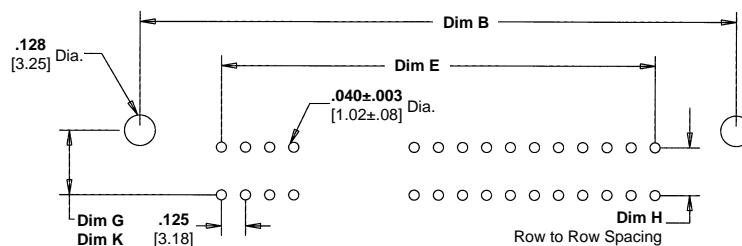
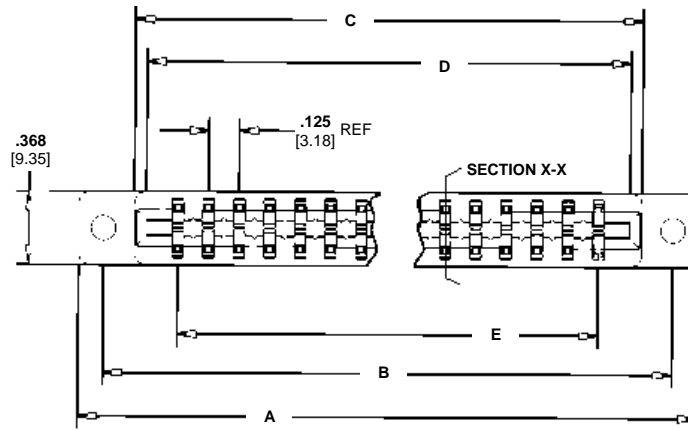

Dim G - Centered Mounting Ear .125 [3.18] Cross Drilled Hole Only  
Dim K - Flush Mounting Ear .125 [3.18] Cross Drilled Hole Only

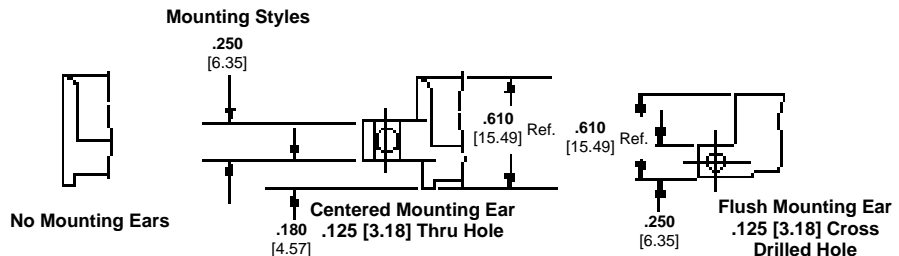
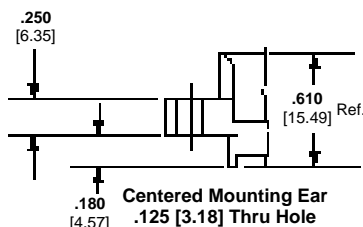

**Mounting Styles**

No Mounting Ears

Centered Mounting Ear  
.180 [4.57] .125 [3.18] Thru Hole

Flush Mounting Ear  
.125 [3.18] Cross Drilled Hole

**.125" [3.18] Centerline / .200" [5.08] and .150" [3.81] Row-to-Row (Dim. "H") Spacing**

No. of Dual Readout Positions	Dimensions					Mounting Ear Options					
	A	B	C	D	E	Centered Mounting Ear Only G	Flush Mounting Ear Only K	Centered Mounting Ear .125" [3.18] Thru Hole	No Mounting Ears	Centered Mounting Ear .125" [3.18] Cross-Drilled Hole	Flush Mounting Ear .125" [3.18] Cross-Drilled Hole
<b>.150" [3.81] Row-to-Row (Dim. "H") Spacing</b>											
6	1.555 39.50	1.295 32.89	1.035 26.29	0.875 22.23	0.625 15.88	0.420 10.67	0.240 6.10	A7D06RA29AM231	A7D06RA29CM231	A7D06RA29EM231	A7D06RA29FM231
10	2.055 52.20	1.795 45.59	1.535 38.99	1.375 34.93	1.125 28.58	0.420 10.67	0.240 6.10	A7D10RA29AM231	A7D10RA29CM231	A7D10RA29EM231	A7D10RA29FM231
15	2.680 68.07	2.420 61.47	2.160 54.86	2.000 50.80	1.750 44.45	0.420 10.67	0.240 6.10	A7D15RA29AM231	A7D15RA29CM231	A7D15RA29EM231	A7D15RA29FM231
18	3.055 77.60	2.795 70.99	2.535 64.39	2.375 60.33	2.125 53.98	0.420 10.67	0.240 6.10	A7D18RA29AM231	A7D18RA29CM231	A7D18RA29EM231	A7D18RA29FM231
22	3.555 90.30	3.295 83.69	3.035 77.09	2.875 73.03	2.625 66.68	0.420 10.67	0.240 6.10	A7D22RA29AM231	A7D22RA29CM231	A7D22RA29EM231	A7D22RA29FM231
25	3.930 99.82	3.670 93.22	3.410 86.61	3.250 82.55	3.000 76.20	0.420 10.67	0.240 6.10	A7D25RA29AM231	A7D25RA29CM231	A7D25RA29EM231	A7D25RA29FM231
28	4.305 109.35	4.045 102.74	3.785 96.14	3.625 92.08	3.375 85.73	0.420 10.67	0.240 6.10	A7D28RA29AM231	A7D28RA29CM231	A7D28RA29EM231	A7D28RA29FM231
30	4.555 115.70	4.295 109.09	4.035 102.49	3.875 98.43	3.625 92.08	0.420 10.67	0.240 6.10	A7D30RA29AM231	A7D30RA29CM231	A7D30RA29EM231	A7D30RA29FM231
35	5.180 131.57	4.920 124.97	4.660 118.36	4.500 114.30	4.250 107.95	0.420 10.67	0.240 6.10	A7D35RA29AM231	A7D35RA29CM231	A7D35RA29EM231	A7D35RA29FM231
36	5.305 134.75	5.045 128.14	4.785 121.54	4.625 117.48	4.375 111.13	0.420 10.67	0.240 6.10	A7D36RA29AM231	A7D36RA29CM231	A7D36RA29EM231	A7D36RA29FM231
40	5.805 147.45	5.545 140.84	5.285 134.24	5.125 130.18	4.875 123.83	0.420 10.67	0.240 6.10	A7D40RA29AM231	A7D40RA29CM231	A7D40RA29EM231	A7D40RA29FM231
43	6.180 156.97	5.920 150.37	5.660 143.76	5.500 139.70	5.250 133.35	0.420 10.67	0.240 6.10	A7D43RA29AM231	A7D43RA29CM231	A7D43RA29EM231	A7D43RA29FM231
50	7.055 179.20	6.795 172.59	6.535 165.99	6.375 161.93	6.125 155.58	0.420 10.67	0.240 6.10	A7D50RA29AM231	A7D50RA29CM231	A7D50RA29EM231	A7D50RA29FM231
<b>.200" [5.08] Row-to-Row (Dim. "H") Spacing</b>											
6	1.555 39.50	1.295 32.89	1.035 26.29	0.875 22.23	0.625 15.88	0.470 11.94	0.290 7.37	A7D06RA29AM232	A7D06RA29CM232	A7D06RA29EM232	A7D06RA29FM232
10	2.055 52.20	1.795 45.59	1.535 38.99	1.375 34.93	1.125 28.58	0.470 11.94	0.290 7.37	A7D10RA29AM232	A7D10RA29CM232	A7D10RA29EM232	A7D10RA29FM232
15	2.680 68.07	2.420 61.47	2.160 54.86	2.000 50.80	1.750 44.45	0.470 11.94	0.290 7.37	A7D15RA29AM232	A7D15RA29CM232	A7D15RA29EM232	A7D15RA29FM232
18	3.055 77.60	2.795 70.99	2.535 64.39	2.375 60.33	2.125 53.98	0.470 11.94	0.290 7.37	A7D18RA29AM232	A7D18RA29CM232	A7D18RA29EM232	A7D18RA29FM232
22	3.555 90.30	3.295 83.69	3.035 77.09	2.875 73.03	2.625 66.68	0.470 11.94	0.290 7.37	A7D22RA29AM232	A7D22RA29CM232	A7D22RA29EM232	A7D22RA29FM232
25	3.930 99.82	3.670 93.22	3.410 86.61	3.250 82.55	3.000 76.20	0.470 11.94	0.290 7.37	A7D25RA29AM232	A7D25RA29CM232	A7D25RA29EM232	A7D25RA29FM232
28	4.305 109.35	4.045 102.74	3.785 96.14	3.625 92.08	3.375 85.73	0.470 11.94	0.290 7.37	A7D28RA29AM232	A7D28RA29CM232	A7D28RA29EM232	A7D28RA29FM232
30	4.555 115.70	4.295 109.09	4.035 102.49	3.875 98.43	3.625 92.08	0.470 11.94	0.290 7.37	A7D30RA29AM232	A7D30RA29CM232	A7D30RA29EM232	A7D30RA29FM232
35	5.180 131.57	4.920 124.97	4.660 118.36	4.500 114.30	4.250 107.95	0.470 11.94	0.290 7.37	A7D35RA29AM232	A7D35RA29CM232	A7D35RA29EM232	A7D35RA29FM232
36	5.305 134.75	5.045 128.14	4.785 121.54	4.625 117.48	4.375 111.13	0.470 11.94	0.290 7.37	A7D36RA29AM232	A7D36RA29CM232	A7D36RA29EM232	A7D36RA29FM232
40	5.805 147.45	5.545 140.84	5.285 134.24	5.125 130.18	4.875 123.83	0.470 11.94	0.290 7.37	A7D40RA29AM232	A7D40RA29CM232	A7D40RA29EM232	A7D40RA29FM232
43	6.180 156.97	5.920 150.37	5.660 143.76	5.500 139.70	5.250 133.35	0.470 11.94	0.290 7.37	A7D43RA29AM232	A7D43RA29CM232	A7D43RA29EM232	A7D43RA29FM232
50	7.055 179.20	6.795 172.59	6.535 165.99	6.375 161.93	6.125 155.58	0.470 11.94	0.290 7.37	A7D50RA29AM232	A7D50RA29CM232	A7D50RA29EM232	A7D50RA29FM232

.125" [3.18] Centerline / .250" [6.35] Row-to-Row (Dim. "H") Spacing

No. of Dual Readout Positions	Dimensions					Centered Mounting Ear Only G	Flush Mounting Ear Only K	Centered Mounting Ear .125" [3.18] Thru Hole	Mounting Ear Options		
	A	B	C	D	E				No Mounting Ears	Centered Mounting Ear .125" [3.18] Cross-Drilled Hole	Flush Mounting Ear .125" [3.18] Cross-Drilled Hole
<b>.250" [6.35] Row-to-Row (Dim. "H") Spacing</b>											
6	1.555 39.50	1.295 32.89	1.035 26.29	0.875 22.23	0.625 15.88	0.520 13.21	0.340 8.64	A7D06RA29A	A7D06RA29C	A7D06RA29E	A7D06RA29F
10	2.055 52.20	1.795 45.59	1.535 38.99	1.375 34.93	1.125 28.58	0.520 13.21	0.340 8.64	A7D10RA29A	A7D10RA29C	A7D10RA29E	A7D10RA29F
15	2.680 68.07	2.420 61.47	2.160 54.86	2.000 50.80	1.750 44.45	0.520 13.21	0.340 8.64	A7D15RA29A	A7D15RA29C	A7D15RA29E	A7D15RA29F
18	3.055 77.60	2.795 70.99	2.535 64.39	2.375 60.33	2.125 53.98	0.520 13.21	0.340 8.64	A7D18RA29A	A7D18RA29C	A7D18RA29E	A7D18RA29F
22	3.555 90.30	3.295 83.69	3.035 77.09	2.875 73.03	2.625 66.68	0.520 13.21	0.340 8.64	A7D22RA29A	A7D22RA29C	A7D22RA29E	A7D22RA29F
25	3.930 99.82	3.670 93.22	3.410 86.61	3.250 82.55	3.000 76.20	0.520 13.21	0.340 8.64	A7D25RA29A	A7D25RA29C	A7D25RA29E	A7D25RA29F
28	4.305 109.35	4.045 102.74	3.785 96.14	3.625 92.08	3.375 85.73	0.520 13.21	0.340 8.64	A7D28RA29A	A7D28RA29C	A7D28RA29E	A7D28RA29F
30	4.555 115.70	4.295 109.09	4.035 102.49	3.875 98.43	3.625 92.08	0.520 13.21	0.340 8.64	A7D30RA29A	A7D30RA29C	A7D30RA29E	A7D30RA29F
35	5.180 131.57	4.920 124.97	4.660 118.36	4.500 114.30	4.250 107.95	0.520 13.21	0.340 8.64	A7D35RA29A	A7D35RA29C	A7D35RA29E	A7D35RA29F
36	5.305 134.75	5.045 128.14	4.785 121.54	4.625 117.48	4.375 111.13	0.520 13.21	0.340 8.64	A7D36RA29A	A7D36RA29C	A7D36RA29E	A7D36RA29F
40	5.805 147.45	5.545 140.84	5.285 134.24	5.125 130.18	4.875 123.83	0.520 13.21	0.340 8.64	A7D40RA29A	A7D40RA29C	A7D40RA29E	A7D40RA29F
43	6.180 156.97	5.920 150.37	5.660 143.76	5.500 139.70	5.250 133.35	0.520 13.21	0.340 8.64	A7D43RA29A	A7D43RA29C	A7D43RA29E	A7D43RA29F
50	7.055 179.20	6.795 172.59	6.535 165.99	6.375 161.93	6.125 155.58	0.520 13.21	0.340 8.64	A7D50RA29A	A7D50RA29C	A7D50RA29E	A7D50RA29F

Solder Type Board-to-Board Connectors

**Product Facts**

- Recognized under the Component Program of Underwriters Laboratories Inc., File No. E60980 
- Certified by Canadian Standards Association, File No. LR49571 

**Physical Properties:**

**Insulation Resistance**—5000 megohms minimum.

**Insertion/Withdrawal Force (Daughter Card)**—8 oz./2 oz. [35.6 N/ 8.9 N] average contact pair using .0620 [1.57] steel blade.

**Insulator Body**—Glass filled thermoplastic, UL rating 94V-0. High temp. plastic option is available; add suffix M399 to part number.

**Color**—Black

**Contacts**—High strength copper alloy.

**Contact Plating**—.000050 [0.00127] nickel underplate with .000030 [0.00076] gold in the mating area, tin/lead on tails, .000100 [0.00254] minimum

**Electrical Properties:**

**Operation Voltage**—1500 VDC (sea level)

**Current Rating**—3 Amperes

**Initial Contact Resistance**—10 milliohms

**Environmental Properties:**

**Operating Temperature**—-55°C to +125°C

**Temperature Cycling**—MIL-STD-202 method 107

**Vibration**—MIL-STD-202 method 204

**Related Product Data:**

**Polarization Key**—page 57

**Daughter Card Edge Pattern**—page 57

**Modified Bellows Connectors, .156 x .200 [3.96 x 5.08] Centerline, Straight Dip Solder and Wire Wrap Tails**

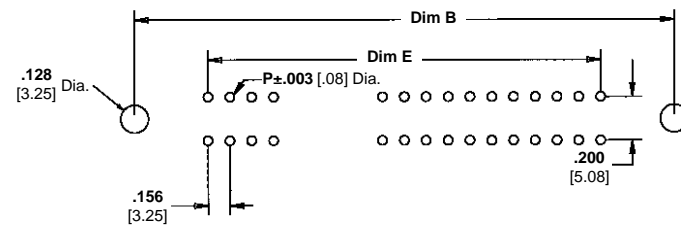
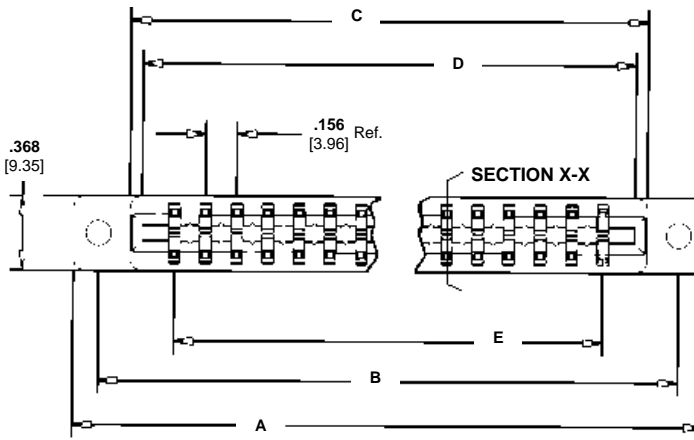
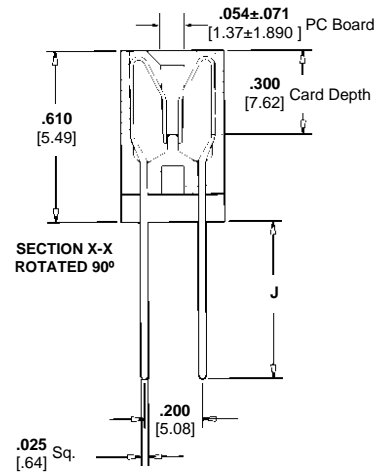

P=.040 [1.02] Dip Solder Applications  
P=.042 [1.07] For Wire Wrap Applications

**Mounting Styles**

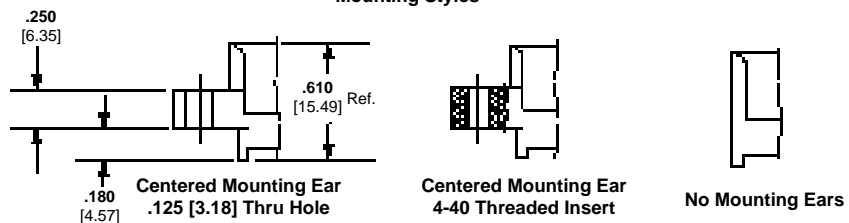

Solder Type Board-to-Board Connectors



.156" [3.96] Centerline / .200" [5.08] Row-to-Row

No. of Dual Readout Positions	Dimensions					Mounting Ear Options		
	A	B	C	D	E	Centered Mounting Ear .125" [3.18] Thru Hole	Centered Mounting Ear 4-40 Threaded Insert	No Mounting Ears
<b>Tail Length .160" [4.06] (DIM "J")</b>								
6	1.784 45.31	1.534 38.96	1.221 31.01	1.100 27.94	0.780 19.81	A6D06DS29A2	A6D06DS29B2	A6D06DS29C2
10	2.408 61.16	2.158 54.81	1.845 46.86	1.724 43.79	1.404 35.66	A6D10DS29A2	A6D10DS29B2	A6D10DS29C2
12	2.720 69.09	2.470 62.74	2.157 54.79	2.036 51.71	1.716 43.59	A6D12DS29A2	A6D12DS29B2	A6D12DS29C2
15	3.188 80.98	2.938 74.63	2.625 66.68	2.504 63.60	2.184 55.47	A6D15DS29A2	A6D15DS29B2	A6D15DS29C2
18	3.656 92.86	3.406 86.51	3.093 78.56	2.972 75.49	2.652 67.36	A6D18DS29A2	A6D18DS29B2	A6D18DS29C2
22	4.280 108.71	4.030 102.36	3.717 94.41	3.596 91.34	3.276 83.21	A6D22DS29A2	A6D22DS29B2	A6D22DS29C2
25	4.748 120.60	4.498 114.25	4.185 106.30	4.064 103.23	3.744 95.10	A6D25DS29A2	A6D25DS29B2	A6D25DS29C2
28	5.216 132.49	4.966 126.14	4.653 118.19	4.532 115.11	4.212 106.98	A6D28DS29A2	A6D28DS29B2	A6D28DS29C2
36	6.464 164.19	6.214 157.84	5.901 149.89	5.780 146.81	5.460 138.68	A6D36DS29A2	A6D36DS29B2	A6D36DS29C2
43	7.556 191.92	7.306 185.57	6.993 177.62	6.872 174.55	6.552 166.42	A6D43DS29A2	A6D43DS29B2	A6D43DS29C2
<b>Tail Length .220" [5.59] (DIM "J")</b>								
6	1.784 45.31	1.534 38.96	1.221 31.01	1.100 27.94	0.780 19.81	A6D06DS29A3	A6D06DS29B3	A6D06DS29C3
10	2.408 61.16	2.158 54.81	1.845 46.86	1.724 43.79	1.404 35.66	A6D10DS29A3	A6D10DS29B3	A6D10DS29C3
12	2.720 69.09	2.470 62.74	2.157 54.79	2.036 51.71	1.716 43.59	A6D12DS29A3	A6D12DS29B3	A6D12DS29C3
15	3.188 80.98	2.938 74.63	2.625 66.68	2.504 63.60	2.184 55.47	A6D15DS29A3	A6D15DS29B3	A6D15DS29C3
18	3.656 92.86	3.406 86.51	3.093 78.56	2.972 75.49	2.652 67.36	A6D18DS29A3	A6D18DS29B3	A6D18DS29C3
22	4.280 108.71	4.030 102.36	3.717 94.41	3.596 91.34	3.276 83.21	A6D22DS29A3	A6D22DS29B3	A6D22DS29C3
25	4.748 120.60	4.498 114.25	4.185 106.30	4.064 103.23	3.744 95.10	A6D25DS29A3	A6D25DS29B3	A6D25DS29C3
28	5.216 132.49	4.966 126.14	4.653 118.19	4.532 115.11	4.212 106.98	A6D28DS29A3	A6D28DS29B3	A6D28DS29C3
36	6.464 164.19	6.214 157.84	5.901 149.89	5.780 146.81	5.460 138.68	A6D36DS29A3	A6D36DS29B3	A6D36DS29C3
43	7.556 191.92	7.306 185.57	6.993 177.62	6.872 174.55	6.552 166.42	A6D43DS29A3	A6D43DS29B3	A6D43DS29C3
<b>Tail Length .560" [14.22] (DIM "J") For Wire Wrap Termination</b>								
6	1.784 45.31	1.534 38.96	1.221 31.01	1.100 27.94	0.780 19.81	A6D06WW29A3	A6D06WW29B3	-
10	2.408 61.16	2.158 54.81	1.845 46.86	1.724 43.79	1.404 35.66	A6D10WW29A3	A6D10WW29B3	-
12	2.720 69.09	2.470 62.74	2.157 54.79	2.036 51.71	1.716 43.59	A6D12WW29A3	A6D12WW29B3	-
15	3.188 80.98	2.938 74.63	2.625 66.68	2.504 63.60	2.184 55.47	A6D15WW29A3	A6D15WW29B3	-
18	3.656 92.86	3.406 86.51	3.093 78.56	2.972 75.49	2.652 67.36	A6D18WW29A3	A6D18WW29B3	-
22	4.280 108.71	4.030 102.36	3.717 94.41	3.596 91.34	3.276 83.21	A6D22WW29A3	A6D22WW29B3	-
25	4.748 120.60	4.498 114.25	4.185 106.30	4.064 103.23	3.744 95.10	A6D25WW29A3	A6D25WW29B3	-
28	5.216 132.49	4.966 126.14	4.653 118.19	4.532 115.11	4.212 106.98	A6D28WW29A3	A6D28WW29B3	-
36	6.464 164.19	6.214 157.84	5.901 149.89	5.780 146.81	5.460 138.68	A6D36WW29A3	A6D36WW29B3	-
43	7.556 191.92	7.306 185.57	6.993 177.62	6.872 174.55	6.552 166.42	A6D43WW29A3	A6D43WW29B3	-

Solder Type Board-to-Board Connectors

*Electronics*

**Modified Bellows Connectors .156 x .200 [3.96 x 5.08] Centerline, .156 x .150 [3.96 x 3.81], Right Angle, Dip Solder Tails**

**Product Facts**

- **Recognized under the Component Program of Underwriters Laboratories Inc., File No. E60980** 
- **Certified by Canadian Standards Association, File No. LR49571** 

**Physical Properties:**

**Insulation Resistance**—5000 megohms minimum.

**Insertion/Withdrawal Force (Daughter Card)**—8 oz./2 oz. [35.6 N/ 8.9 N] average contact pair using .0620 [1.57] steel blade.

**Insulator Body**—Glass filled thermoplastic, UL rating 94V-0. High temp. plastic option is available; add suffix M399 to part number.

**Color**—Black

**Contacts**—High strength copper alloy.

**Contact Plating**—.000050 [0.00127] nickel underplate with .000030 [0.00076] gold in the mating area, tin/lead on tails, .000100 [0.00254] minimum

**Electrical Properties:**

**Operation Voltage**—1500 VDC (sea level)

**Current Rating**—3 Amperes

**Initial Contact Resistance**—10 milliohms

**Environmental Properties:**

**Operating Temperature**—-55°C to +125°C

**Temperature Cycling**—MIL-STD-202 method 107

**Vibration**—MIL-STD-202 method 204

**Related Product Data:**

**Polarization Key**—page 57

**Daughter Card Edge Pattern**—page 57

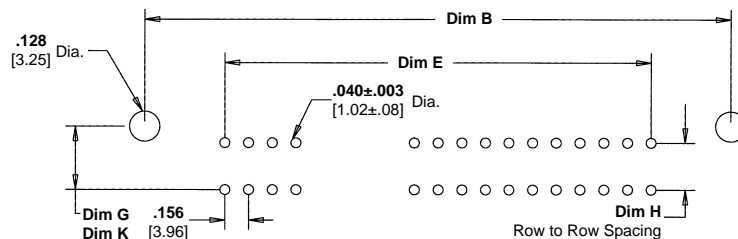
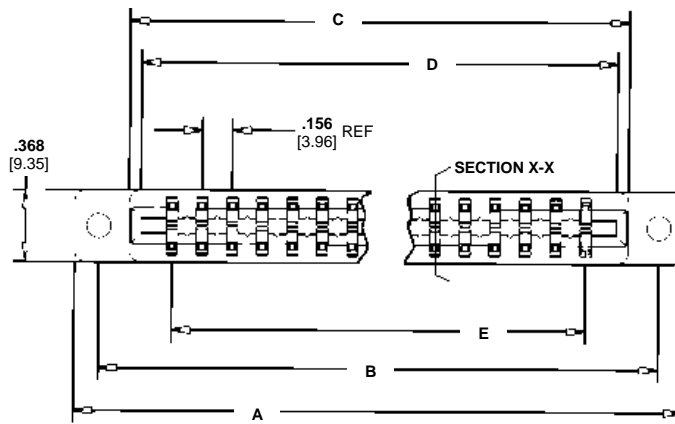
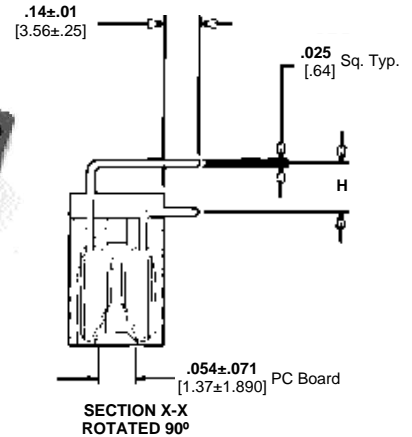

Dim G - Centered Mounting Ear .125 [3.18] Cross Drilled Hole Only  
Dim K - Flush Mounting Ear .125 [3.18] Cross Drilled Hole Only

**Mounting Styles**

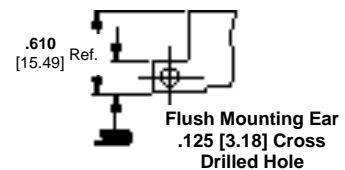
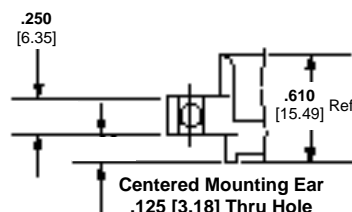
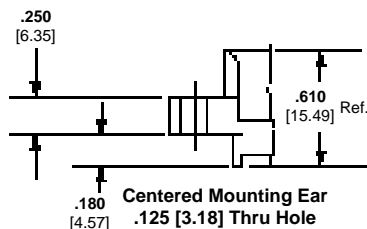

.156" [3.96] Centerline / .200" [5.08] and .150" [3.81] Row-to-Row (Dim. "H") Spacing

No. of Dual Readout Positions	Dimensions						Mounting Ear Options				
	A	B	C	D	E	Centered Mounting Ear Only G	Flush Mounting Ear Only K	Centered Mounting Ear .125" [3.18] Thru Hole	No Mounting Ears	Centered Mounting Ear .125" [3.18] Cross-Drilled Hole	Flush Mounting Ear .125" [3.18] Cross-Drilled Hole
<b>.200" [5.08] Row-to-Row (Dim. "H") Spacing</b>											
6	1.784 45.31	1.534 38.96	1.221 31.01	1.100 27.94	0.780 19.81	0.470 11.94	0.290 7.37	A6D06RA29A	A6D06RA29C	A6D06RA29E	A6D06RA29F
10	2.408 61.16	2.158 54.81	1.845 46.86	1.724 43.79	1.404 35.66	0.470 11.94	0.290 7.37	A6D10RA29A	A6D10RA29C	A6D10RA29E	A6D10RA29F
12	2.720 69.09	2.470 62.74	2.157 54.79	2.036 51.71	1.716 43.59	0.470 11.94	0.290 7.37	A6D12RA29A	A6D12RA29C	A6D12RA29E	A6D12RA29F
15	3.188 80.98	2.938 74.63	2.625 66.68	2.504 63.60	2.184 55.47	0.470 11.94	0.290 7.37	A6D15RA29A	A6D15RA29C	A6D15RA29E	A6D15RA29F
18	3.656 92.86	3.406 86.51	3.093 78.56	2.972 75.49	2.652 67.36	0.470 11.94	0.290 7.37	A6D18RA29A	A6D18RA29C	A6D18RA29E	A6D18RA29F
22	4.280 108.71	4.030 102.36	3.717 94.41	3.596 91.34	3.276 83.21	0.470 11.94	0.290 7.37	A6D22RA29A	A6D22RA29C	A6D22RA29E	A6D22RA29F
25	4.748 120.60	4.498 114.25	4.185 106.30	4.064 103.23	3.744 95.10	0.470 11.94	0.290 7.37	A6D25RA29A	A6D25RA29C	A6D25RA29E	A6D25RA29F
28	5.216 132.49	4.966 126.14	4.653 118.19	4.532 115.11	4.212 106.98	0.470 11.94	0.290 7.37	A6D28RA29A	A6D28RA29C	A6D28RA29E	A6D28RA29F
36	6.464 164.19	6.214 157.84	5.901 149.89	5.780 146.81	5.460 138.68	0.470 11.94	0.290 7.37	A6D36RA29A	A6D36RA29C	A6D36RA29E	A6D36RA29F
40	7.088 180.04	6.838 173.69	6.525 165.74	6.404 162.66	6.084 154.53	0.470 11.94	0.290 7.37	A6D40RA29A	A6D40RA29C	A6D40RA29E	A6D40RA29F
43	7.556 191.92	7.306 185.57	6.993 177.62	6.872 174.55	6.552 166.42	0.470 11.94	0.290 7.37	A6D43RA29A	A6D43RA29C	A6D43RA29E	A6D43RA29F
<b>.150" [3.81] Row-to-Row (Dim. "H") Spacing</b>											
6	1.784 45.31	1.534 38.96	1.221 31.01	1.100 27.94	0.780 19.81	0.420 10.67	0.240 6.10	A6D06RA29AM233	A6D06RA29CM233	A6D06RA29EM233	A6D06RA29FM233
10	2.408 61.16	2.158 54.81	1.845 46.86	1.724 43.79	1.404 35.66	0.420 10.67	0.240 6.10	A6D10RA29AM233	A6D10RA29CM233	A6D10RA29EM233	A6D10RA29FM233
12	2.720 69.09	2.470 62.74	2.157 54.79	2.036 51.71	1.716 43.59	0.420 10.67	0.240 6.10	A6D12RA29AM233	A6D12RA29CM233	A6D12RA29EM233	A6D12RA29FM233
15	3.188 80.98	2.938 74.63	2.625 66.68	2.504 63.60	2.184 55.47	0.420 10.67	0.240 6.10	A6D15RA29AM233	A6D15RA29CM233	A6D15RA29EM233	A6D15RA29FM233
18	3.656 92.86	3.406 86.51	3.093 78.56	2.972 75.49	2.652 67.36	0.420 10.67	0.240 6.10	A6D18RA29AM233	A6D18RA29CM233	A6D18RA29EM233	A6D18RA29FM233
22	4.280 108.71	4.030 102.36	3.717 94.41	3.596 91.34	3.276 83.21	0.420 10.67	0.240 6.10	A6D22RA29AM233	A6D22RA29CM233	A6D22RA29EM233	A6D22RA29FM233
25	4.748 120.60	4.498 114.25	4.185 106.30	4.064 103.23	3.744 95.10	0.420 10.67	0.240 6.10	A6D25RA29AM233	A6D25RA29CM233	A6D25RA29EM233	A6D25RA29FM233
28	5.216 132.49	4.966 126.14	4.653 118.19	4.532 115.11	4.212 106.98	0.420 10.67	0.240 6.10	A6D28RA29AM233	A6D28RA29CM233	A6D28RA29EM233	A6D28RA29FM233
36	6.464 164.19	6.214 157.84	5.901 149.89	5.780 146.81	5.460 138.68	0.420 10.67	0.240 6.10	A6D36RA29AM233	A6D36RA29CM233	A6D36RA29EM233	A6D36RA29FM233
40	7.088 180.04	6.838 173.69	6.525 165.74	6.404 162.66	6.084 154.53	0.420 10.67	0.240 6.10	A6D40RA29AM233	A6D40RA29CM233	A6D40RA29EM233	A6D40RA29FM233
43	7.556 191.92	7.306 185.57	6.993 177.62	6.872 174.55	6.552 166.42	0.420 10.67	0.240 6.10	A6D43RA29AM233	A6D43RA29CM233	A6D43RA29EM233	A6D43RA29FM233

Solder Type Board-to-Board Connectors

*Electronics*

**Card Edge Polarization Keys**

**Description/Application**

Tyco Electronics can provide polarization keys in the basic configuration shown on this page. Our Modified Bellows and Cantilever Beam Series Card Edge Connectors use these keys. The part number and the connector series for which it was designed are listed in the table below.

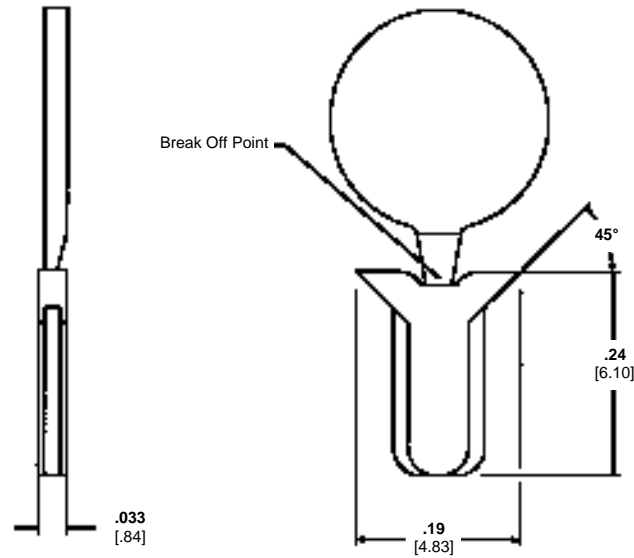

**Ordering Information**

Acquired Part Number	Used on Connector Series	Shown on Pages
98014-01	Modified Bellows	41-56
98014-01	Cantilever Beam	28-40

**Card Edge Connectors Recommended Daughter Card Edge Pattern**

Per MIL-C-21097E

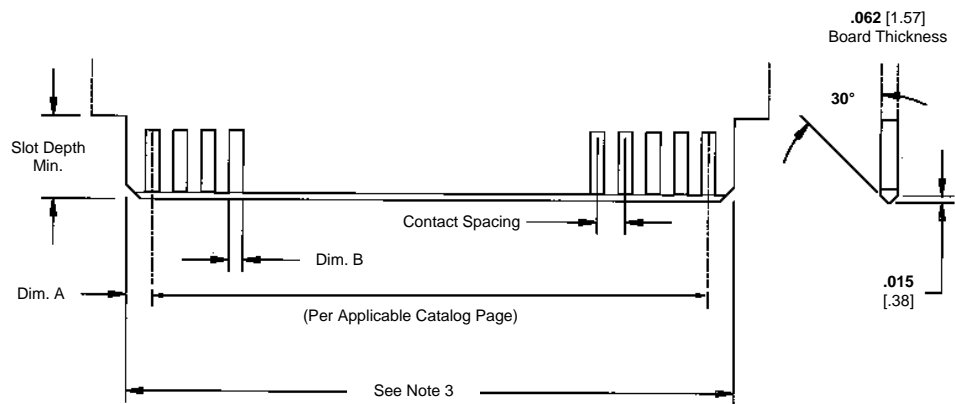

**Daughter Card**

Contact Spacing Non-Accum.	Dim A ±.005 (.13)	Dim B
.100 [2.54]	.093 [2.36]	.052 [1.32]
.125 [3.18]	.093 [2.36]	.052 [1.32]
.156 [3.96]	.105* [2.67]	.094 [2.39]

\* Except MIL-C-21097E 8-4 which is .070 [1.78]

**NOTES:**

- Dimensions are in inches
- Unless otherwise specified, tolerance is ±.005 [0.13 mm] for three place decimals.
- Number of contact fingers shall be the same as the corresponding printed wiring connector.

### Product Facts

- Low profile housing is .460 [11.68] deep
- 6 through 43 dual positions on .156 [3.96] centerline; 6 through 50 dual positions on .125 [3.18] centerline
- Solder eyelet for wire-to-board or solder post for mother-daughter board application
- Selective gold plating of contact area for high performance at low cost
- Alternate platings are available on request
- Contacts bifurcated for redundancy
- Tin plate for high solderability of solder eyelets and posts
- Accepts .055-.070 [1.40-1.78] thick printed circuit boards
- Housings available with or without mounting ears
- Intercontact keying available
- UL 94V-0 rated, glass-filled polyester housings
- Variety of solder post lengths
- 5 ampere current rating per contact\*
- Recognized under the Component Program of Underwriters Laboratories Inc. File No. E28476



For printed circuit board packaging, AMP Low Profile Edge Connectors provide high performance, low cost connections on .125 [3.18] and .156 [3.96] centerline spacings. .100 [2.54] centerline connectors can be made available, consult Tyco Electronics.

Mounted connector housings extend only .460 [11.68] from the mother board to allow efficient use of available space.

These low profile connectors are available in 6 through 43 dual position sizes on .156 [3.96] centerline spacing and with 6 through 50 dual positions on .125 [3.18] centers. Connectors are supplied

with either solder posts for mother-daughter board applications or solder eyelet contacts for wire-to-board use.

Low Profile Edge Connectors feature clear slot entry and accept .055-.070 [1.40-1.78] thick double-sided printed circuit boards. Solder posts are available with .150 [3.18] and .180 [4.57] long tails on .140 [3.56] or .200 [5.08] row-to-row spacing.

Impact-resistant thermo-plastic housing, UL rated 94V-0, have molded-in cavity identification and are available with or without mounting ears. Additional features of the housings include intercontact keying

provisions, probe slots and identification of number one position.

The precision formed contacts made of phosphor bronze are gold plated on the contact mating surface only. This selective plating provides high reliability while maintaining low cost. Solder eyelets and posts are tin plated for excellent solderability. The contact is bifurcated for redundancy. Shorting contacts are available.

All connector configurations are furnished preloaded. Selectively loaded connectors can be made available for added economy.

\*Consult Tyco Electronics engineering when paralleling contacts for power applications.

*Electronics*

**Low Profile Connectors, .125 [3.18] Centerline**

**Material and Finish:**

**Housing**—Green, glass-filled polyester

**Contacts**—Phosphor bronze, duplex plated .000030 [0.00076] gold in contact area; .000100 [0.00254] bright tin on posts, with entire contact under-plated .000030 [0.00076] nickel

**Related Product Data:**

**Keying Plug**—page 63

**PC Board Hole Layouts**—See below

**PC Board Edge Pattern**—page 63

**Technical Documents:**

(pages 186, 187):

Product Specification

108-9044

Instruction Sheet 408-7772

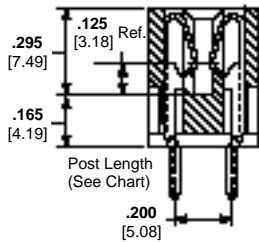
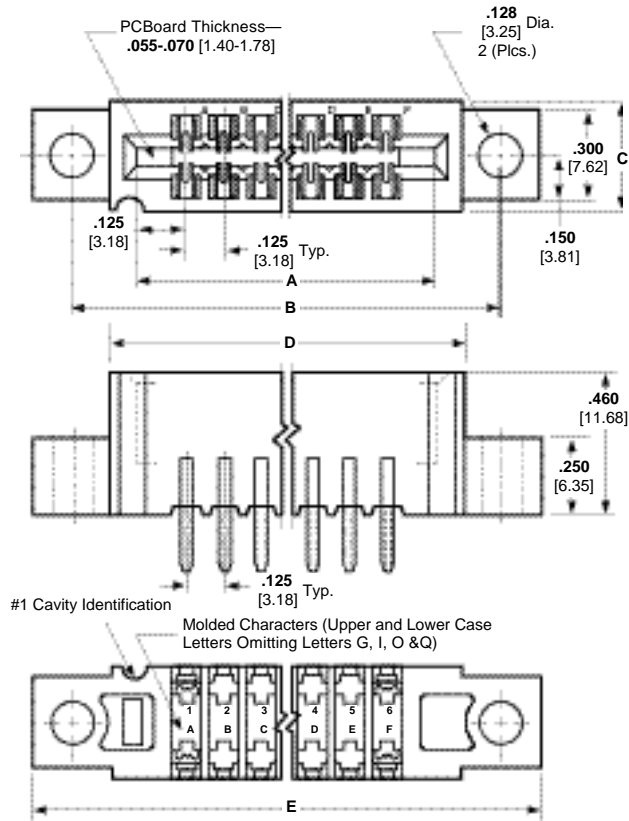

**Flow Solder Post**  
.200 [5.08] Row-to-Row Spacing

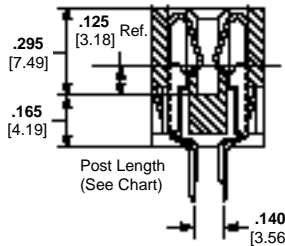

**Flow Solder Post**  
.140 [3.56] Row-to-Row Spacing

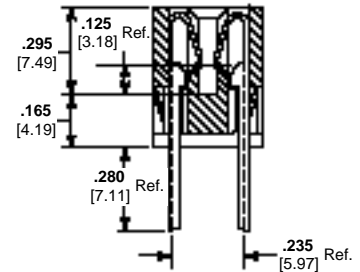

**Solder Eyelet Contact**  
.235 [5.97] Row-to-Row Spacing

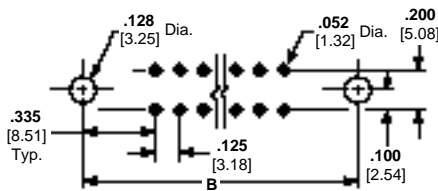

**Recommended PC Board Hole Layout**

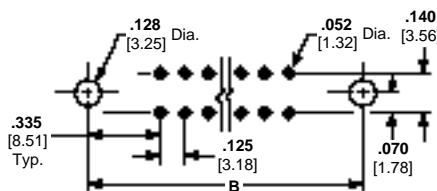

**Recommended PC Board Hole Layout**



**Flow Solder Post  
.200 [5.08] Row-to-Row  
Spacing**

**Low Profile Connectors, .125 [3.18] Centerline** (Continued)

Solder Type Board-to-Board Connectors

No. of Dual Positions	Dimensions					Post Length*	With Mounting Ears	Without Mounting Ears
	A	B	C	D	E			
6	.875	—	.370	1.035	—	.150	—	2-530671-1
	22.23		9.40	26.29				
10	1.375	1.795	.370	1.535	2.055	.150	—	2-530671-2
	34.93	45.59	9.40	38.99	52.20			
15	2.000	2.420	.370	2.160	2.680	.150	—	2-530671-3
	50.80	61.47	9.40	54.86	68.07			
18	2.375	2.795	.370	2.535	3.055	.180	2-530663-4	2-530671-4
	60.33	70.99	9.40	64.39	77.60			
22	2.875	3.295	.370	3.035	3.555	.150	2-530662-5	2-530671-5
	73.03	83.69	9.40	77.09	90.30			
24	3.125	—	.370	3.285	—	.150	—	3-530671-3
	79.38		9.40	83.44				
28	3.625	4.045	.370	3.785	4.305	.150	2-530662-6	2-530671-6
	92.08	102.74	9.40	96.14	109.35			
30	3.875	—	.370	4.035	—	.150	—	2-530671-7
	98.43		9.40	102.49				
36	4.625	5.045	.370	4.785	5.305	.150	—	2-530671-9
	117.48	128.14	9.40	121.54	134.75			
40	5.125	5.545	.437	5.285	5.805	.150	—	3-530671-0
	130.18	140.84	11.10	134.24	147.45			
50	6.375	6.795	.437	6.535	7.055	.150	3-530662-2	—
	161.93	172.59	11.10	165.99	179.20			

**Flow Solder Post  
.140 [3.56] Row-to-Row  
Spacing**

No. of Dual Positions	Dimensions					Post Length*	With Mounting Ears	Without Mounting Ears
	A	B	C	D	E			
15	2.000	—	.370	2.160	—	.150	—	2-530673-3
	50.80		9.40	54.86				
28	3.625	—	.370	3.785	—	.150	—	2-530673-6
	92.08		9.40	96.14				
50	6.375	6.795	.437	6.535	7.055	.180	2-530674-6	—
	161.93	172.59	11.10	165.99	179.20			

**Solder Eyelet Contact  
.235 [5.97] Row-to-Row  
Spacing**

No. of Dual Positions	Dimensions					With Mounting Ears
	A	B	C	D	E	
15	2.000	2.420	.370	2.160	2.680	2-530664-3
	50.80	61.47	9.40	54.86	68.07	
22	2.875	3.295	.370	3.035	3.555	2-530664-5
	73.02	83.69	9.40	77.08	90.29	
28	3.625	4.045	.370	3.785	4.305	2-530664-6
	92.08	102.74	9.40	96.14	109.35	
40	5.125	5.545	.437	5.285	5.805	3-530664-0
	130.17	140.84	11.10	134.23	147.44	
50	6.375	6.795	.437	6.535	7.055	3-530664-2
	161.92	172.59	11.10	165.98	179.19	

\*Metric equivalents for post length are .150 = [3.81]; .180 = [4.57].

**Note:** Other connector sizes can be made available, consult Tyco Electronics.

**Material and Finish:**

**Housing**—Green, glass-filled polyester

**Contacts**—Phosphor bronze, duplex plated .000030 [0.00076] gold in contact area; .000100 [0.00254] bright tin on posts, with entire contact under-plated .000030 [0.00076] nickel

**Insert**—Brass

**Related Product Data:**

**Keying Plug**—page 63

**PC Board Hole Layouts**—See below

**PC Board Edge Pattern**—page 63

**Technical Documents:**

(pages 186, 187):

Product Specification

108-9044

Instruction Sheet 408-7772

**Mounting Ear with Insert**



Threaded Inserts  
4-40 NC-2B  
(2 per connector)

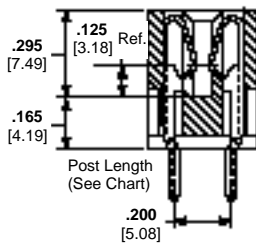
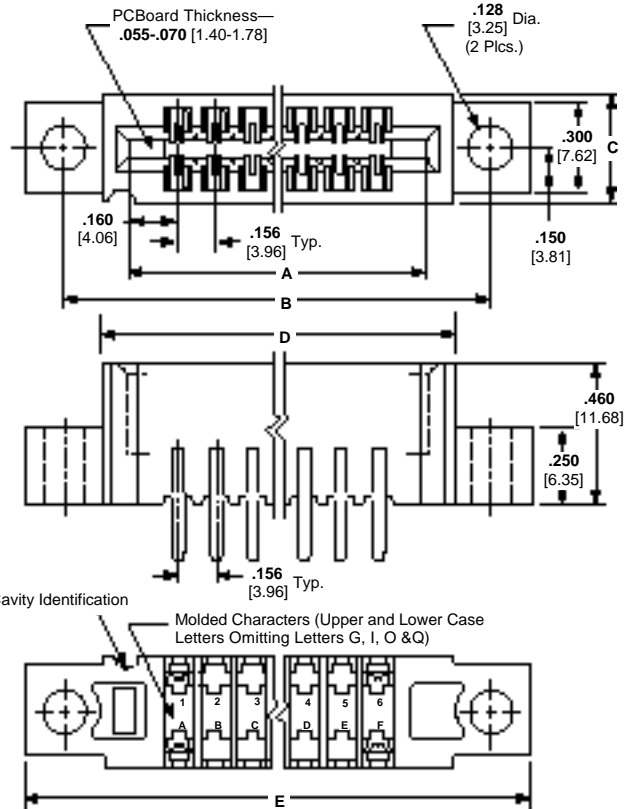

**Flow Solder Post**  
.200 [5.08] Row-to-Row Spacing

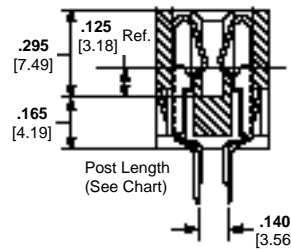

**Flow Solder Post**  
.140 [3.56] Row-to-Row Spacing

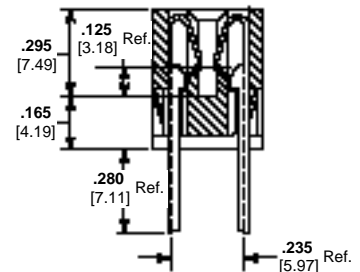

**Solder Eyelet Contact**  
.235 [5.97] Row-to-Row Spacing

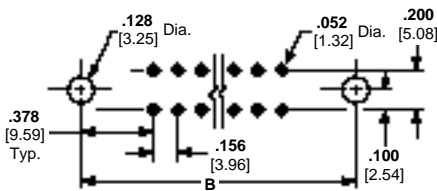

**Recommended PC Board Hole Layout**

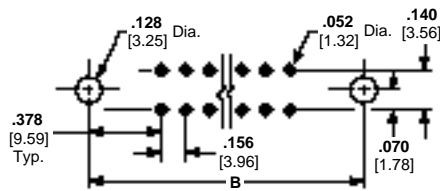

**Recommended PC Board Hole Layout**

**Flow Solder Post  
.200 [5.08] Row-to-Row  
Spacing**

**Low Profile Connectors, .156 [3.96] Centerline (Continued)**

Solder Type Board-to-Board Connectors

No. of Dual Positions	Dimensions					Post Length*	With Mounting Ears	With Mounting Ears and Inserts	Without Mounting Ears
	A	B	C	D	E				
6	<b>1.100</b>	<b>1.535</b>	<b>.370</b>	<b>1.240</b>	<b>1.785</b>	<b>.150</b>	2-530655-1	2-530677-1	—
	27.94	38.99	9.40	31.50	45.34		2-530689-11	—	2-530666-1
10	<b>1.724</b>	<b>2.159</b>	<b>.370</b>	<b>1.864</b>	<b>2.409</b>	<b>.150</b>	2-530655-2	—	2-530666-2
	43.79	54.84	9.40	47.35	61.19		<b>.180</b>	2-530656-2	—
12	<b>2.036</b>	<b>2.471</b>	<b>.370</b>	<b>2.176</b>	<b>2.721</b>	<b>.150</b>	2-530655-3	—	2-530666-3
	51.71	62.76	9.40	55.27	69.11		2-530655-4	—	2-530666-4
15	<b>2.504</b>	<b>2.939</b>	<b>.370</b>	<b>2.644</b>	<b>3.189</b>	<b>.150</b>	2-530689-4 <sup>1</sup>	—	—
	63.60	74.65	9.40	67.16	81.00		2-530655-5	—	2-530666-5
18	<b>2.972</b>	<b>3.407</b>	<b>.370</b>	<b>3.112</b>	<b>3.657</b>	<b>.150</b>	—	—	2-530667-5
	75.49	86.54	9.40	79.04	92.89		2-530655-6	—	2-530666-6
22	<b>3.596</b>	<b>4.031</b>	<b>.370</b>	<b>3.736</b>	<b>4.281</b>	<b>.150</b>	2-530689-6 <sup>1</sup>	—	531433-4 <sup>1</sup>
	91.34	102.39	9.40	94.89	108.74		<b>.180</b>	2-530656-6	2-530678-6
25	<b>4.064</b>	<b>4.499</b>	<b>.370</b>	<b>4.204</b>	<b>4.749</b>	<b>.150</b>	2-530655-8	—	531433-1 <sup>1</sup>
	103.23	114.27	9.40	106.78	120.62		<b>.180</b>	2-530656-8	—
28	<b>4.532</b>	<b>4.967</b>	<b>.370</b>	<b>4.672</b>	<b>5.217</b>	<b>.150</b>	3-530655-2	—	3-530666-2
	115.11	126.16	9.40	118.67	132.51		<b>.180</b>	3-530656-2	—
30	<b>4.844</b>	<b>5.279</b>	<b>.437</b>	<b>4.984</b>	<b>5.529</b>	<b>.150</b>	2-530655-9	—	2-530666-9
	123.04	134.09	11.10	126.59	140.44		2-530689-9 <sup>1</sup>	—	—
36	<b>5.780</b>	<b>6.215</b>	<b>.437</b>	<b>5.920</b>	<b>6.465</b>	<b>.150</b>	3-530655-0	—	531433-2 <sup>1</sup>
	146.18	157.86	11.10	150.37	164.21		<b>.180</b>	3-530689-0 <sup>1</sup>	—
43	<b>6.872</b>	<b>7.307</b>	<b>.437</b>	<b>7.012</b>	<b>7.557</b>	<b>.150</b>	3-530655-3	3-530677-3	3-530666-3
	174.55	185.60	11.10	178.10	191.95		<b>.180</b>	3-530656-3	—

**Flow Solder Post  
.140 [3.56] Row-to-Row  
Spacing  
and  
Solder Eyelet Contact  
.235 [5.97] Row-to-Row  
Spacing**

No. of Dual Positions	Dimensions					Post Length*	Flow Solder Post		Solder Eyelet Contact	
	A	B	C	D	E		With Mounting Ears	Without Mounting Ears	With Mounting Ears	Without Mounting Ears
6	<b>1.100</b>	<b>1.535</b>	<b>.370</b>	<b>1.240</b>	<b>1.785</b>	<b>.150</b>	—	—	2-530654-1	—
	27.94	38.99	9.40	31.50	45.34		2-530657-2	—	2-530654-2	—
10	<b>1.724</b>	<b>2.159</b>	<b>.370</b>	<b>1.864</b>	<b>2.409</b>	<b>.150</b>	2-530657-4	—	2-530654-4	2-530667-4
	43.79	54.84	9.40	47.35	61.19		<b>.180</b>	—	2-530669-4	—
15	<b>2.504</b>	<b>2.939</b>	<b>.370</b>	<b>2.644</b>	<b>3.189</b>	<b>.150</b>	—	2-530668-5	2-530654-5	—
	63.60	74.65	9.40	67.16	81.00		2-530657-6	2-530668-6	2-530654-6	—
18	<b>2.972</b>	<b>3.407</b>	<b>.370</b>	<b>3.112</b>	<b>3.657</b>	<b>.150</b>	—	—	—	—
	75.49	86.54	9.40	79.04	92.89		2-530657-6	2-530668-6	2-530654-6	—
22	<b>3.596</b>	<b>4.031</b>	<b>.370</b>	<b>3.736</b>	<b>4.281</b>	<b>.150</b>	—	—	2-530654-7	—
	91.34	102.39	9.40	94.89	108.74		—	—	—	—
24	<b>3.908</b>	<b>4.343</b>	<b>.370</b>	<b>4.048</b>	<b>4.593</b>	<b>.150</b>	—	—	—	—
	99.26	110.31	9.40	102.81	116.66		3-530657-2	3-530668-2	3-530654-2	—
28	<b>4.532</b>	<b>4.967</b>	<b>.370</b>	<b>4.672</b>	<b>5.217</b>	<b>.150</b>	—	—	—	—
	115.11	126.16	9.40	118.67	132.51		—	—	—	—
30	<b>4.844</b>	<b>5.279</b>	<b>.437</b>	<b>4.984</b>	<b>5.529</b>	<b>.150</b>	—	—	2-530654-9	—
	123.04	134.09	11.10	126.59	140.44		—	—	—	—
36	<b>5.780</b>	<b>6.215</b>	<b>.437</b>	<b>5.920</b>	<b>6.465</b>	<b>.150</b>	—	—	3-530654-0	—
	146.81	155.58	11.10	150.36	164.21		<b>.180</b>	—	3-530669-0	—
43	<b>6.872</b>	<b>7.307</b>	<b>.437</b>	<b>7.012</b>	<b>7.557</b>	<b>.150</b>	3-530657-3	—	3-530654-3	—
	174.55	185.60	11.10	178.10	191.95		—	—	—	—

\*Metric equivalents for post length are .150 = [3.81]; .180 = [4.57].

<sup>1</sup>For .040 [1.02] diameter hole.

**Note:** Other connector sizes can be made available, consult Tyco Electronics.

**Keying Plug**

**Material:** Glass-filled nylon  
**Part No.** 650025-2

**Intercontact Key**



**Recommended PC Board Edge Patterns**

**.125 [3.18] Centerline Boards**

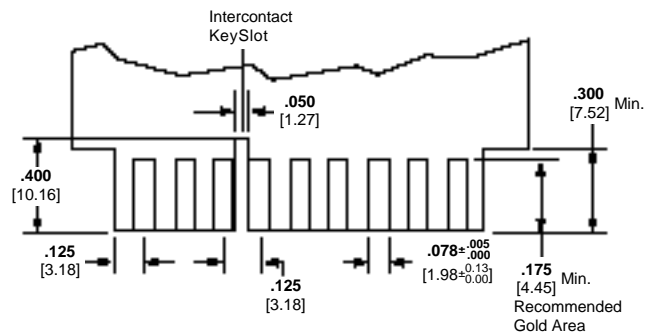

**.156 [3.96] Centerline Boards**

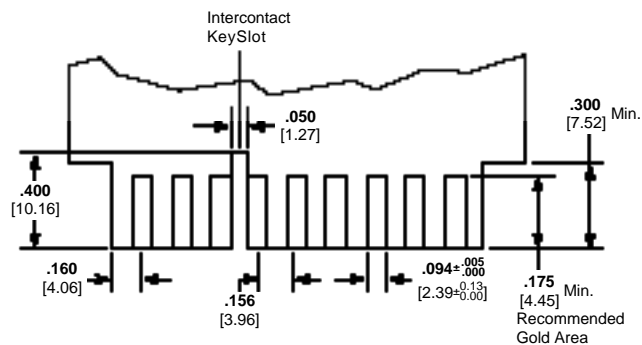

**Product Facts**

- Wide variety of sizes available from 3 dual positions and up—no initial tooling investment required for new versions
- Connectors can be selectively loaded with contacts in custom patterns
- Connectors tooled on all standard centerlines—  
.100 [2.54], .125 [3.18],  
.150 [3.81], .156 [3.96],  
and .200 [5.08]  
*Note:* .200 [5.08] centerline capabilities provided by loading every-other dual position of .100 [2.54] centerline housings.
- Closed card entry protects contacts and daughter board pads
- Adapts to a wide range of mother board thicknesses to .104 [2.64] maximum
- Phosphor bronze contacts selectively plated for top performance and maximum economy
- Protective channel helps prevent overstress of contacts
- Daughter board keying available in intercontact or on-contact styles
- Recognized under the Component Program of Underwriters Laboratories Inc.,  
File No. E28476



\*Consult Tyco Electronics engineering when paralleling contacts for power applications.

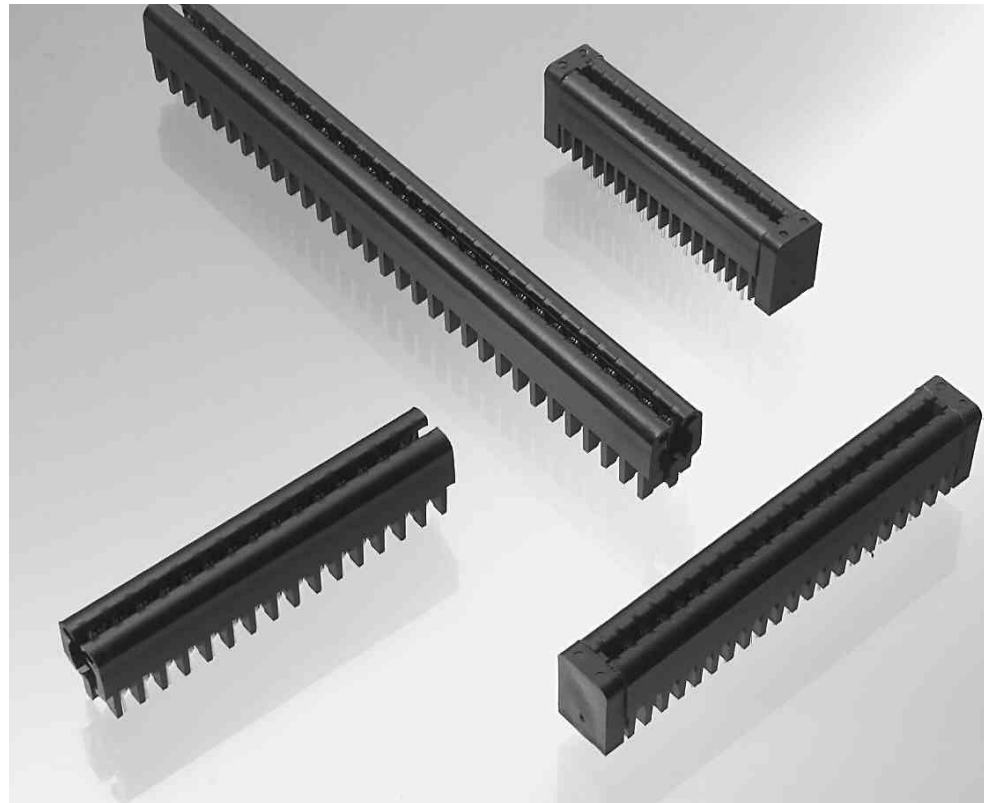

The AMP Twin Leaf Connector is a highly reliable, low-cost mother/daughter board connector designed for solid-state circuitry. The one-piece, multi-contact connector requires no front-end tooling. This versatile connector for double-sided printed circuit boards uses preloaded contacts and selective plating to give lowest applied cost. Critical contact areas are gold-over-nickel plated to provide positive electrical connection between contacts and daughter board pads. Contact posts are tin plated for efficient dip soldering to mother boards up to .104 [2.64] thick. The Twin Leaf Connector delivers high reliability because the contacts possess superior tolerance of environmental stresses including shock, vibration and variations of temperature and humidity. Other characteristics such as high insulation resistance, low

termination resistance, long life and moderate contact separation force meet industry requirements for reliability. Connectors are tooled in sizes from 3 through 80 dual-contact positions with contacts on .100 [2.54], .125 [3.18], .150 [3.81], .156 [3.96] or .200 [5.08] centers. Other sizes and custom-loaded contact patterns are available on request. The connector housing, made of glass-filled polyester with a UL 94V-0 rating, features a standoff which facilitates the use of a probe for electrical continuity checks without risk of damage to the contacts. A closed card-entry design of the housing protects the contacts and daughter board pads. Housings accept daughter boards ranging from .055 [1.40] to .070 [1.78] in thickness. Intercontact and on-contact keys are available for polarization of the housings.

Card guides or end caps make alignment of daughter board pads with Twin Leaf Connector contacts quick and easy.

**Performance Specifications**

**Contact Rating\*:**

3 amperes continuous

**Temperature Rating:**

-55°C to +105°C

**Insulation Resistance:**

5,000 megohms

**Dielectric Withstanding Voltage:**

Altitude	Test Voltage (AC, RMS)	
	.100 [2.54]	.150 [3.81]
Sea Level	1,000	1,500
50,000 ft 15 240 m	400	600
70,000 ft 21 336 m	280	400

**Termination Resistance:**

10 milliohms, max.

**Durability:** Tested to 100 cycles

(engage/withdraw)

**Contact Plating:** .000015 [0.00038]

selective gold plating on contact area; bright tin on solder tie

**Twin Leaf Mother Board Connectors Without End Caps**

**.100 [2.54], .125 [3.18],  
.150 [3.81] and  
.156 [3.96] Centerlines,  
With Solder Posts**

**Material and Finish:**

**Housing**—Glass-filled polyester, 94V-0 rated

**Contacts**—Phosphor bronze, plated .000015 [0.00038] gold in contact area; tin on posts, with entire contact under-plated .000030 [0.00076] nickel, except where noted

**Related Product Data:**

**Performance Specifications**—page 64

**Card Guides**—pages 70, 71

**Keying Plugs**—page 72

**PC Board Hole Layouts**—page 71

**Technical Documents:**

(pages 186, 187):

Product Specification  
108-9027

Instruction Sheets 408-7479,  
408-7498, 408-7506

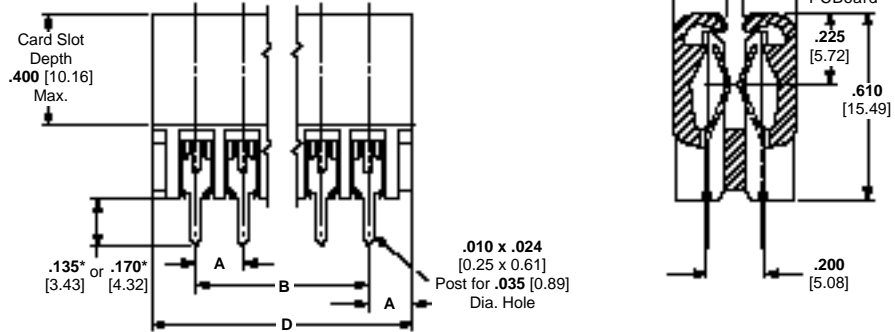

\*Post length: .135 [3.43] for .150 [3.81] and .156 [3.96] centerlines, except where noted;  
.170 [4.32] for .100 [2.54] and .125 [3.18] centerlines, except where noted.



**Twin Leaf Mother Board Connectors Without End Caps**

Solder Type Board-to-Board Connectors

No. of Dual Positions	A = .100 [2.54] Centerline Spacing			A = .125 [3.18] Centerline Spacing			A = .150 [3.81] Centerline Spacing			A = .156 [3.96] Centerline Spacing		
	B	D	Part Numbers	B	D	Part Numbers	B	D	Part Numbers	B	D	Part Numbers
2	—	—	—	—	—	—	.300 7.62	.600 15.24	1-583694-1	—	—	—
3	.200 5.08	.400 10.16	583485-6	—	—	—	.300 7.62	.600 15.24	645155-11 <sup>3</sup>	.312 7.92	.624 15.85	4-583486-8
4	—	—	—	—	—	—	.450 11.43	.750 19.05	583407-5	—	—	—
5	.400 10.16	.600 15.24	583485-7	—	—	—	.600 15.24	.900 22.86	583407-6	—	—	—
8	—	—	—	—	—	—	1.050 26.67	1.350 34.29	583407-9	—	—	—
9	—	—	—	1.000 25.40	1.250 31.75	583533-7	—	—	—	—	—	—
10	.900 22.86	1.100 27.94	1-583485-2	—	—	—	—	—	—	1.400 35.56	1.720 43.69	4-583486-1
11	—	—	—	—	—	—	1.500 38.10	1.800 45.72	1-583407-2	—	—	—
14	1.300 33.02	1.500 38.10	1-583485-6	—	—	—	—	—	—	—	—	—
15	—	—	—	—	—	—	2.100 53.34	2.400 60.96	1-583407-5	—	—	—
18	—	—	—	2.125 53.97	2.375 60.32	1-583533-6	—	—	—	2.652 67.36	2.964 75.28	3-583486-3
20	—	—	—	—	—	—	2.850 72.39	3.150 80.01	2-583407-0 530292-9 <sup>3</sup>	—	—	—
22	—	—	—	2.625 66.67	2.875 73.02	2-583533-0	—	—	—	—	—	—
28	—	—	—	—	—	—	4.050 102.87	4.350 110.49	583407-1	4.212 106.99	4.524 114.91	2-583486-3
30	—	—	—	3.625 92.08	3.875 98.43	531534-2 <sup>2</sup>	—	—	—	4.524 114.91	4.836 122.83	2-583486-1
31	—	—	—	—	—	—	4.500 53.34	4.800 60.96	530292-3 <sup>3</sup>	—	—	—
33	—	—	—	—	—	—	—	—	—	4.992 126.80	5.304 134.72	1-583486-8
36	—	—	—	—	—	—	—	—	—	5.460 138.68	5.772 146.61	1-583486-5
40	—	—	—	4.875 123.83	5.125 130.18	3-583533-8	5.850 148.59	6.150 156.21	3-583407-8	6.084 154.53	6.396 162.46	1-583486-1
43	—	—	—	—	—	—	—	—	—	6.552 166.42	6.864 174.35	583486-8
50	4.900 124.46	5.100 129.54	583485-3	6.130 155.70	6.380 162.05	5-583533-01	7.350 186.69	7.650 194.31	4-583407-8	7.640 194.06	7.960 202.18	583486-1
56	—	—	—	—	—	—	—	—	—	8.580 217.93	8.892 225.86	5-583486-0
65	6.400 162.56	6.600 167.64	5-583485-6	—	—	—	—	—	—	—	—	—
80	7.900 200.66	8.100 205.74	5-583485-5	—	—	—	—	—	—	—	—	—

<sup>1</sup>Contacts are plated .000030 [0.00076] gold in contact area, tin on posts, with entire contact underplated .000030 [0.00076] nickel.

<sup>2</sup>Post length .135 [3.43]

<sup>3</sup>Post length .170 [4.32]

**Note:** Other connector sizes can be made available, consult Tyco Electronics.

**Twin Leaf Mother Board Connectors With End Caps**

**.100 [2.54], .125 [3.18],  
.150 [3.81] and  
.156 [3.96] Centerlines,  
With Solder Posts**

**Material and Finish:**

**Housing**—Glass-filled polyester,  
94V-0 rated

**Contacts**—Phosphor bronze, plated  
.000015 [0.00038] gold in contact area;  
tin on posts, with entire contact under-  
plated .000030 [0.00076] nickel

**Related Product Data:**

**Performance Specifications**—  
page 64

**Keying Plugs**—page 72

**PC Board Hole Layouts**—page 71

**Technical Documents:**

(pages 186, 187):

Product Specification  
108-9027

Instruction Sheets 408-7479,  
408-7498, 408-7506

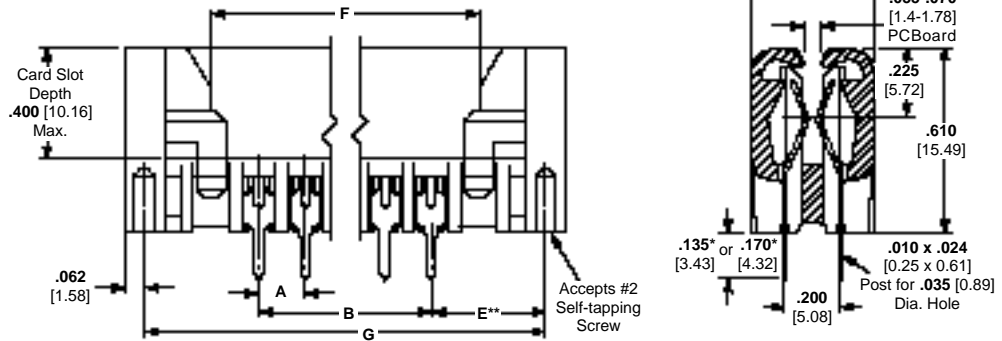

\*Post length: **.135 [3.43]** for **.150 [3.81]** and **.156 [3.96]** centerlines;  
**.170 [4.32]** for **.100 [2.54]** and **.125 [3.18]** centerlines.

\*\*See page 27 for dimensions.

Solder Type Board-to-Board  
Connectors

**Twin Leaf Mother Board Connectors With End Caps**

Solder Type Board-to-Board Connectors

No. of Dual Pos.	A = .100 [2.54] Centerline Spacing				A = .125 [3.18] Centerline Spacing				A = .150 [3.81] Centerline Spacing				A = .156 [3.96] Centerline Spacing			
	B	F	G	Part Numbers	B	F	G	Part Numbers	B	F	G	Part Numbers	B	F	G	Part Numbers
3	.200 5.03	.400 10.16	.734 18.64	583715-1	—	—	—	—	—	—	—	—	—	—	—	—
5	.400 10.16	.600 15.24	.934 23.72	583715-3	—	—	—	—	—	—	—	—	—	—	—	—
6	.500 12.70	.700 17.78	1.034 26.26	583715-4	.625 15.88	.875 22.23	1.259 31.96	583679-5	—	—	—	—	.780 19.81	1.092 27.74	1.538 39.07	583660-6
7	.600 15.24	.800 20.32	1.134 28.80	583715-5	—	—	—	—	—	—	—	—	—	—	—	—
9	.800 20.32	1.000 25.40	1.334 33.88	583715-7	—	—	—	—	—	—	—	—	—	—	—	—
10	.900 22.86	1.100 27.94	1.434 36.42	583715-8	—	—	—	—	—	—	—	—	1.404 35.66	1.716 43.59	2.162 54.91	1-583660-0
12	1.100 27.94	1.300 33.02	1.634 41.50	1-583715-0	—	—	—	—	—	—	—	—	1.716 43.58	2.028 51.51	2.474 62.84	1-583660-2
13	1.200 30.48	1.400 35.56	1.734 44.04	1-583715-1	—	—	—	—	—	—	—	—	—	—	—	—
14	—	—	—	—	—	—	—	—	1.950 49.53	2.250 57.15	2.684 68.17	1-583692-3	2.028 51.51	2.340 59.44	2.786 70.76	1-583660-4
15	1.400 35.56	1.600 40.64	1.934 49.12	1-583715-3	—	—	—	—	2.100 53.34	2.400 60.96	2.834 71.98	1-583692-4	2.184 55.47	2.496 63.40	2.942 74.73	583660-2
17	1.600 40.64	1.800 45.72	2.134 54.20	1-583715-5	2.000 50.80	2.250 57.15	2.634 66.90	1-583679-6	—	—	—	—	—	—	—	—
18	1.700 43.18	1.900 48.26	2.234 56.74	1-583715-6	2.125 53.98	2.375 60.33	2.759 70.08	1-583679-7	—	—	—	—	2.652 67.36	2.964 75.28	3.410 86.61	1-583660-7
20	1.900 48.26	2.100 53.34	2.434 61.82	1-583715-8	2.375 60.33	2.625 66.68	3.009 76.43	1-583679-9	—	—	—	—	—	—	—	—
22	—	—	—	—	—	—	—	—	—	—	—	—	3.276 83.21	3.588 91.14	4.034 102.46	2-583660-1
25	2.400 60.96	2.600 66.04	2.934 74.52	2-583715-3	3.000 76.20	3.250 82.55	3.634 92.30	2-583679-4	3.600 91.44	3.900 99.06	4.334 110.08	2-583692-4	3.744 95.10	4.065 103.02	4.502 114.35	2-583660-4
26	2.500 63.50	2.700 68.58	3.034 77.05	2-583715-4	—	—	—	—	—	—	—	—	—	—	—	—
28	2.700 68.58	2.900 73.66	3.234 82.14	2-583715-6	3.375 85.73	3.625 92.08	4.009 101.83	2-583679-6	—	—	—	—	4.212 106.98	4.524 114.91	4.979 126.24	2-583660-7
30	2.900 73.66	3.100 78.74	3.434 87.22	2-583715-8	—	—	—	—	4.350 110.49	4.650 118.11	5.084 129.13	583692-1	4.524 114.91	4.836 122.83	5.282 134.16	2-583660-9
31	3.000 76.20	3.200 81.28	3.534 89.76	2-583715-9	—	—	—	—	—	—	—	—	—	—	—	—
32	3.100 78.74	3.300 83.82	3.634 92.30	3-583715-0	—	—	—	—	—	—	—	—	4.836 122.83	5.148 130.76	5.594 142.09	3-583660-1
33	—	—	—	—	—	—	—	—	4.800 121.92	5.100 129.54	5.534 140.56	3-583692-1	—	—	—	—
34	3.300 83.82	3.500 88.90	3.834 97.38	3-583715-2	—	—	—	—	—	—	—	—	—	—	—	—
35	3.400 83.36	3.600 91.44	3.934 99.92	3-583715-3	—	—	—	—	5.100 129.54	5.400 137.16	5.834 148.18	3-583692-3	5.304 134.72	5.616 142.64	6.062 153.97	3-583660-4
36	3.500 88.90	3.700 93.98	4.034 102.46	3-583715-4	—	—	—	—	5.250 133.35	5.550 140.97	5.984 151.99	3-583692-4	5.460 138.68	5.772 146.61	6.218 157.94	583660-1
40	3.900 99.06	4.100 104.14	4.434 112.62	3-583715-8	4.875 123.83	5.125 130.18	5.509 139.93	3-583679-8	5.850 148.59	6.150 156.21	6.584 167.23	3-583692-8	—	—	—	—
41	4.000 101.60	4.200 106.68	4.534 115.16	3-583715-9	—	—	—	—	—	—	—	—	—	—	—	—
43	—	—	—	—	—	—	—	—	—	—	—	—	6.552 166.42	6.864 174.35	7.310 185.67	4-583660-1
50	4.900 124.46	5.100 129.54	5.434 138.02	4-583715-8	6.125 155.58	6.375 161.93	6.759 171.68	4-583679-8	7.350 186.69	7.650 194.31	8.084 205.33	4-583692-8	7.644 194.16	7.956 202.08	8.402 213.41	4-583660-8
80	7.900 200.66	8.100 205.74	8.434 214.22	5-583715-7	—	—	—	—	—	—	—	—	—	—	—	—

Note: Other connector sizes can be made available, consult Tyco Electronics.

**Twin Leaf Mother Board Connectors With End Caps** (Continued)

**Typical Connector and Card Guide Assembly**

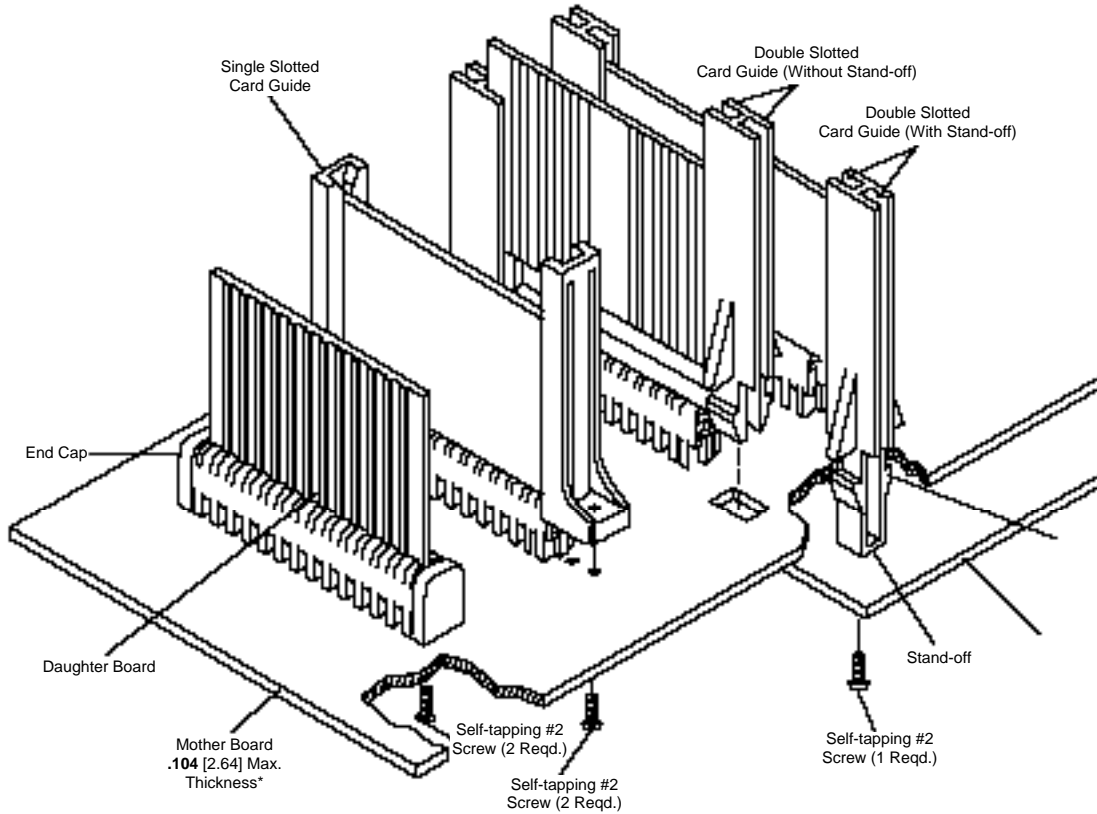

\*Must be .063 [1.59] thick for use with Double Slotted Card Guides.

**Card Guides**

**Material:** Glass-filled nylon, black  
**Part No. 583671-1**

**Related Product Data:**  
**Connectors used with**—page 65

**Technical Documents:**  
(pages 186, 187):  
Instruction Sheets 408-7498,  
408-7506

**Single Slotted**

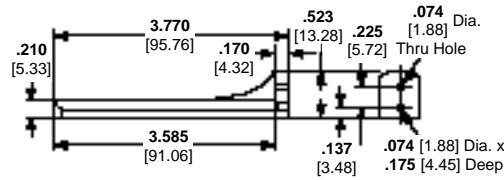

**Single Slotted Card Guide and Connector Mounting**

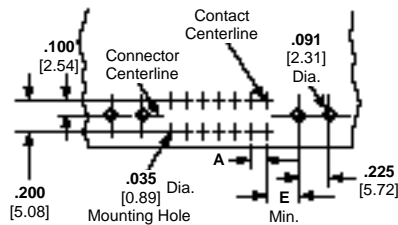

Dimensions	
A	E
.100	.263
2.54	6.68
.125	.288
3.18	7.31
.150	.313
3.81	7.95
.156	.319
3.96	8.10

*Electronics*

**Twin Leaf Mother Board Connectors** (Continued)

**Card Guides**

(Continued)

**Material:** Nylon, natural

**Part No. 583425-1**

**Related Product Data:**

**Connectors used with**—page 65

**Technical Documents:**

(pages 186, 187):

Instruction Sheets 408-7498,  
408-7506

**Double Slotted Without Stand-off**

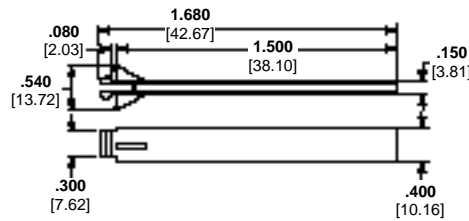

**Double Slotted Card Guide and Connector Mounting**

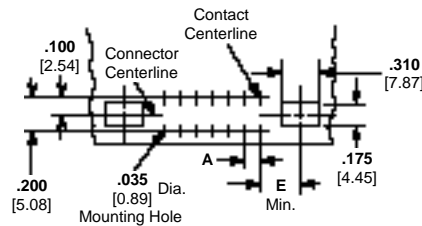

Dimensions	
A	E
.100 2.54	.328 8.33
.125 3.18	.353 8.96
.150 3.81	.376 9.60
.156 3.96	.384 9.75

**Note:** Mother Board must be **.063 [1.59]** thick for use with Double Slotted Card Guides.

**Recommended PC Board Layout for Connectors With End Caps**

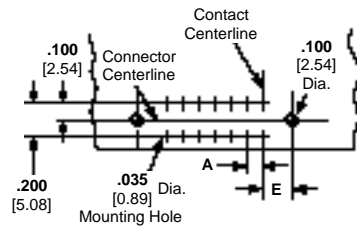

Dimensions	
A	E
.100 2.54	.267 6.78
.125 3.18	.317 8.05
.150 3.81	.367 9.32
.156 3.96	.379 9.62



**Keying Plugs**

**Material:** Nylon, natural

**Technical Documents:**

(pages 186, 187):

Instruction Sheet 408-7479



Type A



Type B



On-Contact

Intercontact

In-Row Contact Spacing	Type of Contact	Connector Style*		Intercontact Keying Plug			On-Contact Keying Plug	
		with End Caps	without End Caps	Type A Part Numbers	Type B Part Numbers	Insertion/Extraction Tool	Part Numbers	Insertion/Extraction Tool
.100 2.54	Solder Post	583715	583485	530286-3	—	91081-2	583714-1	91088-1
	Card Extender	530268	530291					
.125 3.18	Solder Post	583679	583533	530286-2	530030-1	91081-1	583714-1	91088-1
	Card Extender	530265	530290					
.150 3.81	Solder Post	583692	583407	530286-2	530030-1	91081-1	—	—
	Wrap-Type Post	583754	583752					
	Card Extender	530278	530270					
.156 3.96	Solder Post	583660	583486	530286-2	530030-1	91081-1	—	—
	Wrap-Type Post	583755	583753					
	Card Extender	530267	530282					

\*Refer to pages 66-68, as applicable, for specific connector sizes.

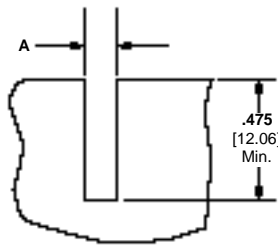

Connector Centerlines	Dimension A	
	Intercontact	On-Contact
.100	.040	.129
2.54	1.02	3.28
.125	.050	.129
3.18	1.27	3.28
.150	.050	.160
3.81	1.27	4.06
.156	.050	.160
3.96	1.27	4.06

Recommended PC Board Cutout for Keying Plugs

**Other Twin Leaf Mother Board Connectors**

For more information on the connectors shown here, consult Tyco Electronics.

**Card Extender Connectors**

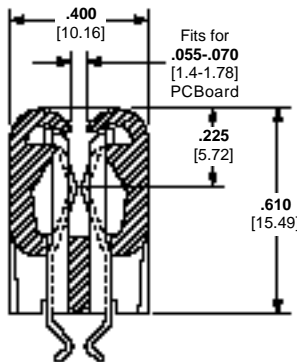

**Connectors With End Caps**

Centerlines	Part Number Series*
.150 3.81	530278
.156 3.96	530267

\*Consult Tyco Electronics for specific connector sizes.

**Rotary Cam ZIF Connectors**

Solder Type Board-to-Board Connectors

**Product Facts**

- Zero insertion force; little or no effort required to insert and withdraw PC boards
- Reduced pad wear for extended board life
- Allows all four sides of board to be used for input/output functions
- Accepts double-sided boards
- Three contact styles to choose from: vertical solder post, right-angle solder post and wrap-type post (2 and 3 high)
- Available in .100 [2.54], .125 [3.18] and .156 [3.96] centerlines
- Three configurations available: open one end, open both ends and closed both ends
- Products indicated are recognized under the Component Program of Underwriters Laboratories Inc., File No. E28476

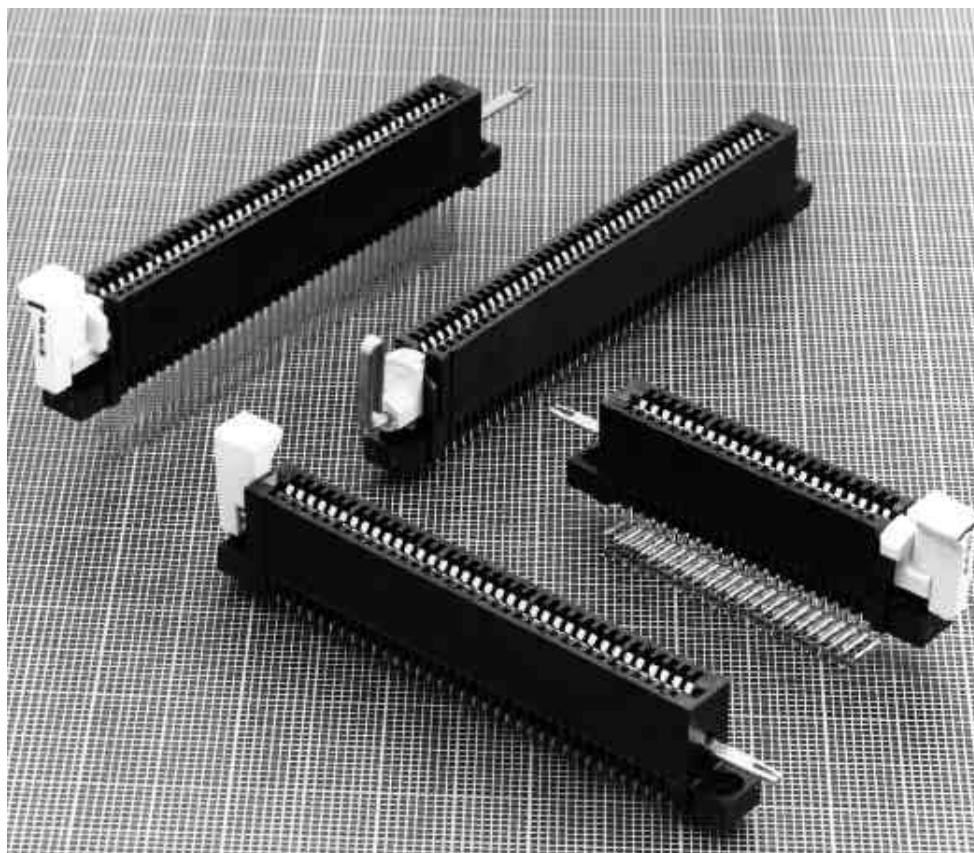

**Performance Specifications**

**Current vs. Temperature Rise\*:**  
3 amperes at 30°C

**Operating Temperature:**  
-55°C to +105°C

**Contact Resistance:**  
20 milliohms max.

**Durability:** Tested to 5000 cycles

AMP Rotary Cam Zero Insertion Force (ZIF) Card Edge Connectors are available in sizes to fit most industry-standard printed circuit boards. A clockwise rotation of the cam handle opens contacts to allow zero-force insertion or removal of PC boards—even boards with a large number of contacts. Turning the cam handle to close the connector locks the board securely in place. Rotary Cam ZIF Connectors accept double-sided PC boards .054-.070 [1.37-

1.78] thick, with contact centerline intervals of .100 [2.54], .125 [3.18] and .156 [3.96]. Row-to-row spacing of connector posts is .200 [5.08] for .100 [2.54] and .156 [3.96] connectors and .250 [6.35] for .125 [3.18] connectors.

Contacts are nickel underplated phosphor bronze with gold plate in the contact area and tin-lead plated posts. Contact configurations include vertical and right-angle solder posts and wrap-type posts. Preassembled connectors

feature housings made from 94V-0 rated glass-filled polyester and mounting ears for easy mounting to the mother board. Housings are available with one end open, both ends open and both ends closed for side and top daughter board insertion. Integral board locks secure boards in the connectors. Accessories include dust covers, cam rods (with and without boots) and cam keys for nut-driver actuation and for tandem operation of connectors.

\*Consult Tyco Electronics engineering when paralleling contacts for power applications.

**Rotary Cam ZIF Connectors, .100 x .200 [2.54 x 5.08] Centerline**

**Vertical Connector,  
Solder Post Terminals**

**Material and Finish:**

**Housing**—Glass-filled polyester, 94V-0 rated

**Contacts**—Phosphor bronze, plated .000030 [0.00076] gold per MIL-G-45204 in contact area; .000100 [0.00254] tin-lead per MIL-P-81728 on post with entire contact underplated .000050 [0.00127] nickel per QQ-N-290

**Related Product Data:**

**Board Lock Feature**—On connectors open one end and open both ends

**Daughter PC Board**—.054-.070 [1.37-1.78] thick

**Performance Specifications**—page 73

**Dust Cover**—page 79

**PC Board Hole Layout and Edge Patterns**—pages 81, 82

**Special Application**—pages 82, 96

**Technical Documents:**

(pages 186, 187):

Product Specification  
108-9048

Instruction Sheet 408-7911

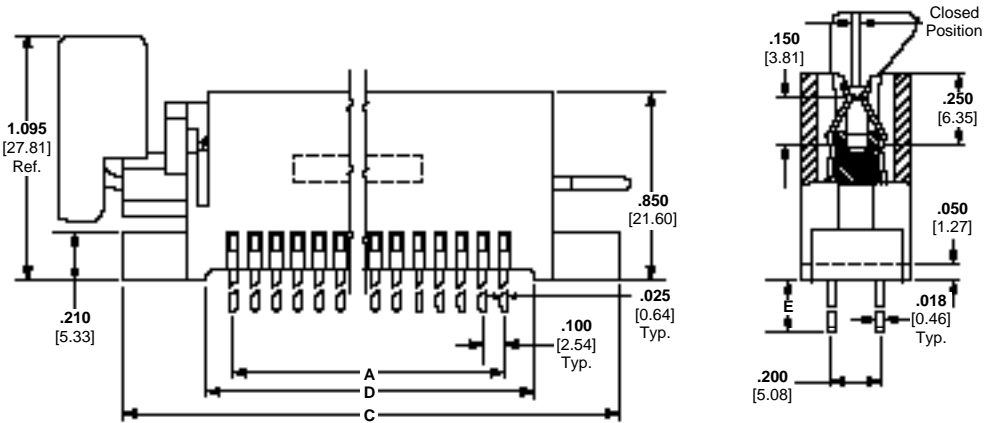
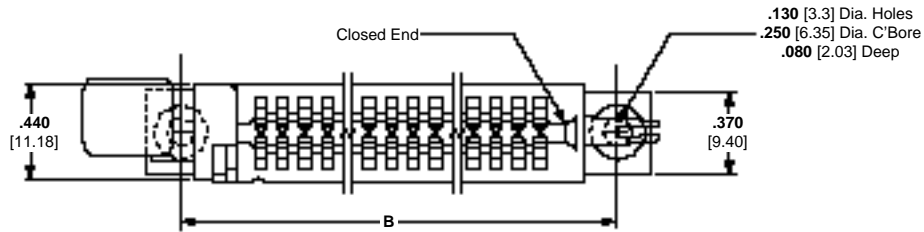

No. of Dual Positions	Dimensions					Part Numbers		
	A	B	C	D	E*	Open One End <sup>1</sup>	Open Both Ends <sup>1</sup>	Closed Both Ends
22	2.100	2.800	3.100	2.300	.125	531020-1	—	531019-1
	53.34	71.12	78.74	58.42	.160	1-531020-1	—	—
25	2.400	3.100	3.400	2.600	.125	531020-2	—	531019-2
	60.96	78.74	86.36	66.04	.160	1-531020-2	—	—
28	2.700	3.400	3.700	2.900	.160	1-531020-3	—	—
	68.58	86.36	93.98	73.66				
31	3.000	3.700	4.000	3.200	.160	2-531020-1	—	—
	76.20	93.98	101.60	81.28				
36	3.500	4.200	4.500	3.700	.125	3-531020-2	—	531019-4
	88.90	106.68	114.30	93.98	.160	1-531020-4	—	—
40	3.900	4.600	4.900	4.100	.125	531020-5	—	—
	99.06	116.84	124.46	104.14	.160	1-531020-5	—	—
43	4.200	4.900	5.200	4.400	.125	3-531020-3	—	—
	106.68	124.46	132.08	111.76	.160	1-531020-7	—	—
50	4.900	5.600	5.900	5.100	.125	531020-8	531021-8	—
	124.46	142.24	149.86	129.54	.160	1-531020-8	—	1-531019-8
60	5.900	6.600	6.900	6.100	.160	2-531020-9 <sup>2</sup>	—	—
	149.86	167.64	175.26	154.94		1-531020-9	1-531021-9	1-531019-9
65	6.400	7.100	7.400	6.600	.125	1-531020-0	—	—
	162.56	180.34	187.96	167.64	.160	2-531020-0	—	—
						3-531020-0 <sup>2</sup>	—	—

\*Metric equivalents in millimeters for post lengths E are .125 = [3.18]; .160 = [4.06].

<sup>1</sup>Recognized under the Component Program of Underwriters Laboratories Inc.

<sup>2</sup>Connectors without cam rod and boardlock.

**Notes:** 1. Connector with card slot open one end is shown for illustration purposes.  
2. Other connector sizes can be made available, consult Tyco Electronics.

**Right-Angle Connector, Solder Post Terminals**

**Material and Finish:**

**Housing**—Glass-filled polyester, 94V-0 rated

**Contacts**—Phosphor bronze, plated .000030 [0.00076] gold per MIL-G-45204 in contact area; .000100 [0.00254] tin-lead per MIL-P-81728 on post with entire contact underplated .000050 [0.00127] nickel per QQ-N-290

**Related Product Data:**

**Board Lock Feature**—On connectors open one end and open both ends

**Daughter PC Board**—.054-.070 [1.37-1.78] thick

**Performance Specifications**—page 73

**Dust Cover**—page 79

**PC Board Hole Layout and Edge Patterns**—pages 81, 82

**Special Application**—page 82, 96

**Technical Documents:**

(pages 186, 187):

Product Specification 108-9048

Instruction Sheet 408-7911

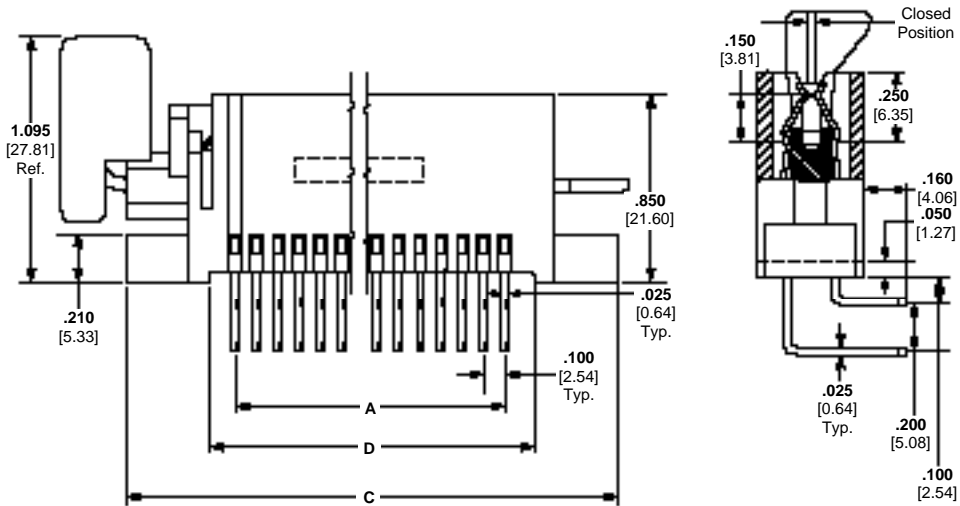
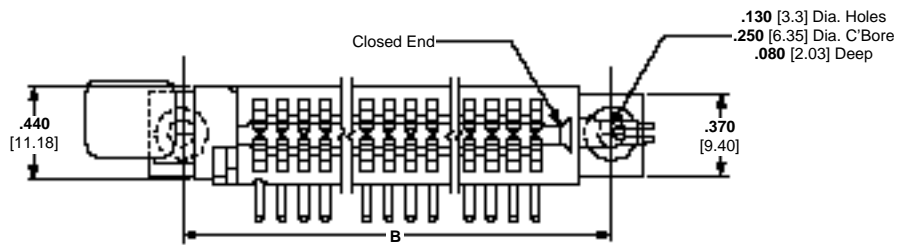
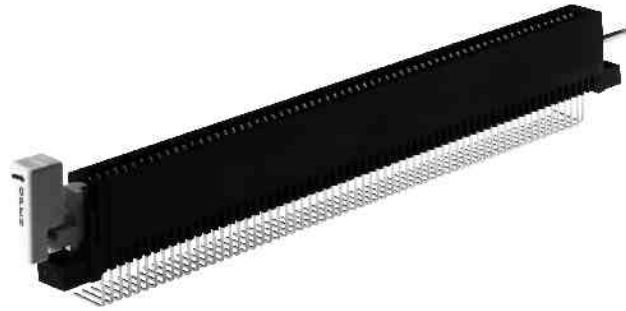

No. of Dual Positions	Dimensions				Bend Right	Part Numbers (Open End <sup>1</sup> )
	A	B	C	D		
25	2.400 60.96	3.100 78.74	3.400 86.36	2.800 71.12	R	531395-2 <sup>3</sup>
36	3.500 88.90	4.200 106.68	4.500 114.30	3.700 93.98	R	531396-4
50	4.900 124.56	5.600 142.24	5.900 149.86	5.100 129.54	L	1-531396-8
65	6.400 162.56	7.100 180.34	7.400 187.96	6.600 167.64	R	1-531396-0

<sup>1</sup>Recognized under the Component Program of Underwriters Laboratories Inc.

- Notes:**
1. Connector with card slot open one end is shown.
  2. Other connector sizes can be made available, consult Tyco Electronics.
  3. Open both ends.

**Vertical Connector,  
Wrap-Type Post Terminals**

**Material and Finish:**

**Housing**—Glass-filled polyester, 94V-0 rated

**Contacts**—Phosphor bronze, plated .000030 [0.00076] gold per MIL-G-45204 in contact area; .000100 [0.00254] tin-lead per MIL-P-81728 on post with entire contact underplated .000050 [0.00127] nickel per QQ-N-290

**Related Product Data:**

**Board Lock Feature**—On connectors open one end and open both ends

**Daughter PC Board**—.054-.070 [1.37-1.78] thick

**Performance Specifications**—page 73

**Dust Cover**—page 79

**PC Board Hole Layout and Edge Patterns**—pages 81, 82

**Special Application**—pages 82, 96

**Technical Documents:**

(pages 186, 187):

Product Specification 108-9048

Instruction Sheet 408-7911

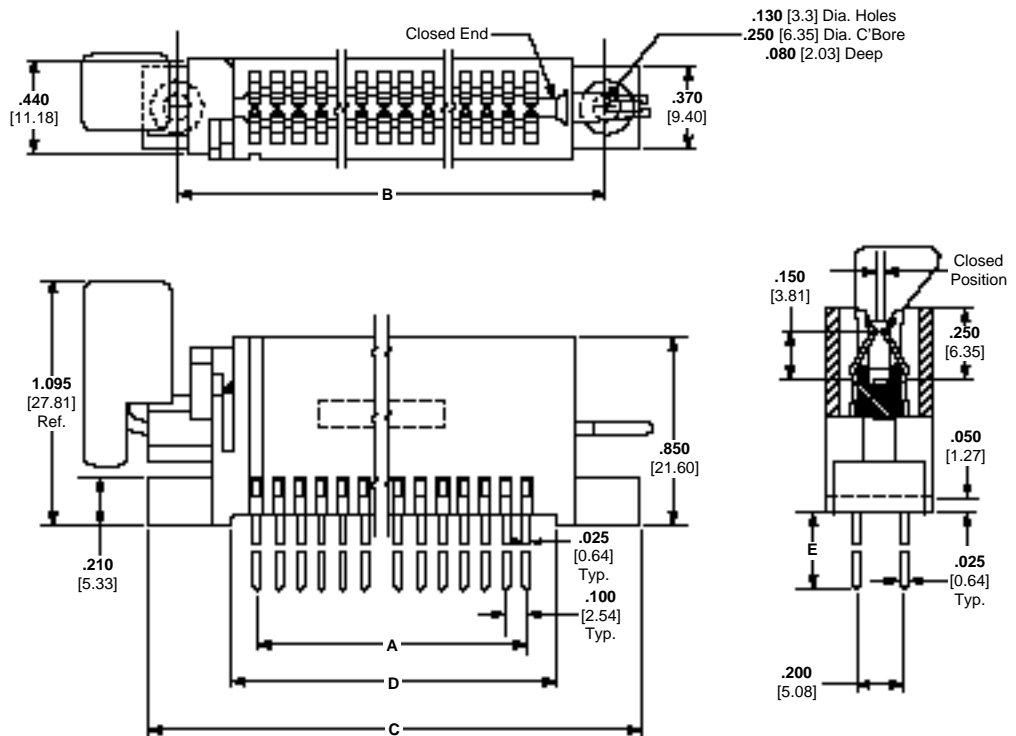

No. of Dual Positions	Dimensions					Part Numbers	
	A	B	C	D	E*	Open One End <sup>1</sup>	Open Both Ends <sup>1</sup>
25	2.400 60.96	3.100 78.74	3.400 86.36	2.600 66.04	.380	1-531414-2	—
36	3.500 88.90	4.200 106.68	4.500 114.30	3.700 93.98	.580 .380	531414-4 1-531414-4	531415-4 —
40	3.900 99.06	4.600 116.84	4.900 124.46	4.100 104.14	.580	531414-5	—
42	4.100 104.14	4.800 121.92	5.100 129.54	4.300 109.22	.380	1-531414-6	—
50	4.900 124.46	5.600 142.24	5.900 149.86	5.100 129.54	.580	2-531414-4	531415-8
60	5.900 149.86	6.600 167.64	6.900 175.26	6.100 154.94	.580	531414-9	—
65	6.400 162.56	7.100 180.34	7.400 187.96	6.600 167.64	.580	1-531414-0	—

\*Metric equivalents in millimeters for post lengths E are .580 = [14.73] (3-high wrap-type); .380 = [9.65] (2-high wrap-type).

<sup>1</sup>Recognized under the Component Program of Underwriters Laboratories Inc.

**Notes:** 1. Connector with card slot open one end is shown for illustration purposes.  
2. Other connector sizes can be made available, consult Tyco Electronics.



**Rotary Cam ZIF Connectors, .125 x .250 [3.18 x 6.35] Centerline**

**Vertical Connector, Solder Post Terminals**

**Material and Finish:**

**Housing**—Glass-filled polyester, 94V-0 rated  
**Contacts**—Phosphor bronze, plated .000030 [0.00076] gold per MIL-G-45204 in contact area; .000100 [0.00254] tin-lead per MIL-P-81728 on post with entire contact underplated .000050 [0.00127] nickel per QQ-N-290

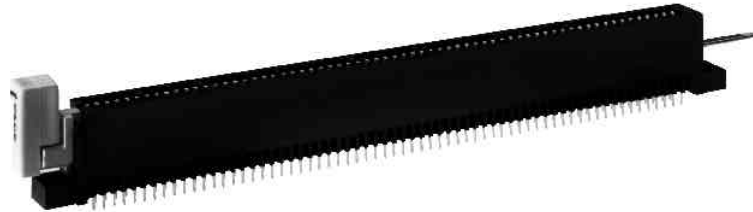

**Related Product Data:**

- Board Lock Feature**—On connectors open one end and open both ends
- Daughter PC Board**—.054-.070 [1.37-1.78] thick
- Performance Specifications**—page 73
- Dust Cover**—page 79
- PC Board Hole Layout and Edge Patterns**—pages 81, 82
- Special Application**—pages 82, 96

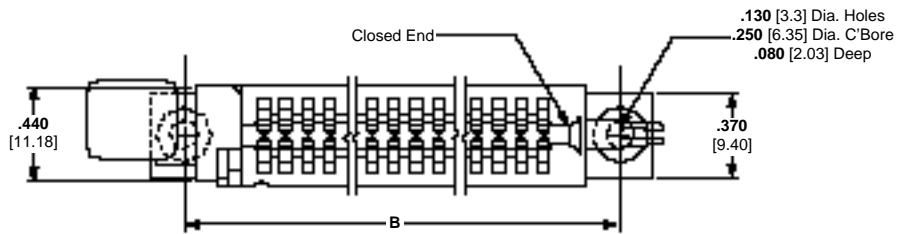

**Technical Documents:**

- (pages 186,187):
- Product Specification 108-9048
- Instruction Sheet 408-7911

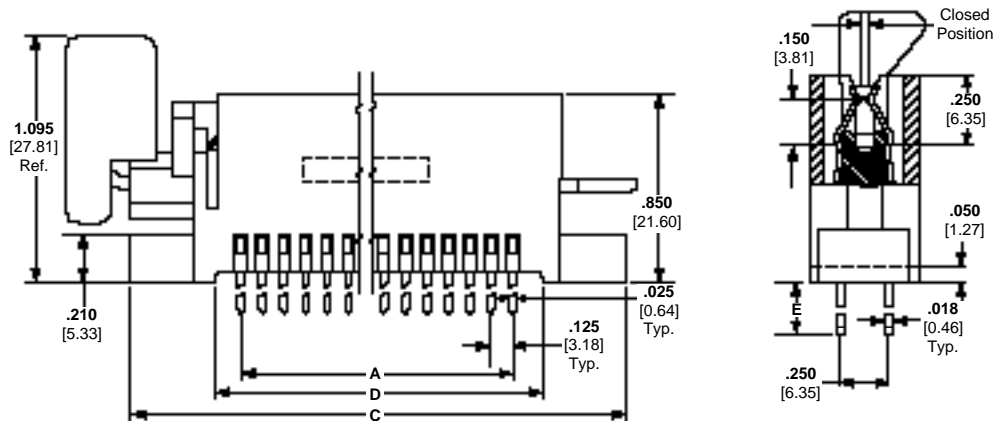

No. of Dual Positions	Dimensions					Part Numbers	
	A	B	C	D	E*	Open One End <sup>1</sup>	Open Both Ends <sup>1</sup>
28	3.375 85.73	4.125 104.76	4.425 112.40	3.625 92.08	.125	—	531024-3
30	3.625 92.08	4.375 111.13	4.675 118.75	3.875 98.43	.125	531023-4	—
40	4.875 123.83	5.625 142.88	5.925 150.50	5.125 130.18	.160	1-531023-4	1-531024-4

\*Metric equivalents in millimeters for post lengths E are .125 = [3.18]; .160 = [4.06].

<sup>1</sup>Recognized under the Component Program of Underwriters Laboratories Inc.

**Notes:** 1. Connector with card slot open one end is shown for illustration purposes.  
 2. Other connector sizes can be made available, consult Tyco Electronics.



**Rotary Cam ZIF Connectors, .156 x .200 [3.96 x 5.08] Centerline**

**Vertical Connector,  
Solder Post Terminals**

**Material and Finish:**

**Housing**—Glass-filled polyester, 94V-0 rated  
**Contacts**—Phosphor bronze, plated .000030 [0.00076] gold per MIL-G-45204 in contact area; .000100 [0.00254] tin-lead per MIL-P-81728 on post with entire contact underplated .000050 [0.00127] nickel per QQ-N-290

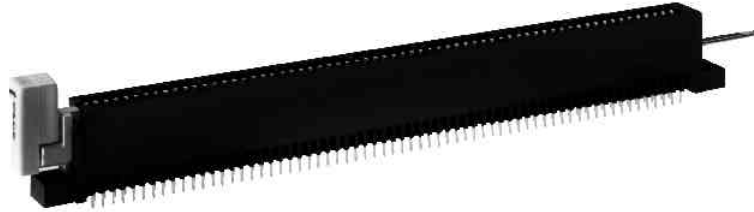

**Related Product Data:**

**Board Lock Feature**—On connectors open one end and open both ends  
**Daughter PC Board**—.054-.070 [1.37-1.78] thick  
**Performance Specifications**—page 73  
**Dust Cover**—page 79  
**PC Board Hole Layout and Edge Patterns**—pages 81, 82  
**Special Application**—pages 82, 96

**Technical Documents:**

(pages 186, 187):  
 Product Specification 108-9048  
 Instruction Sheet 408-7911

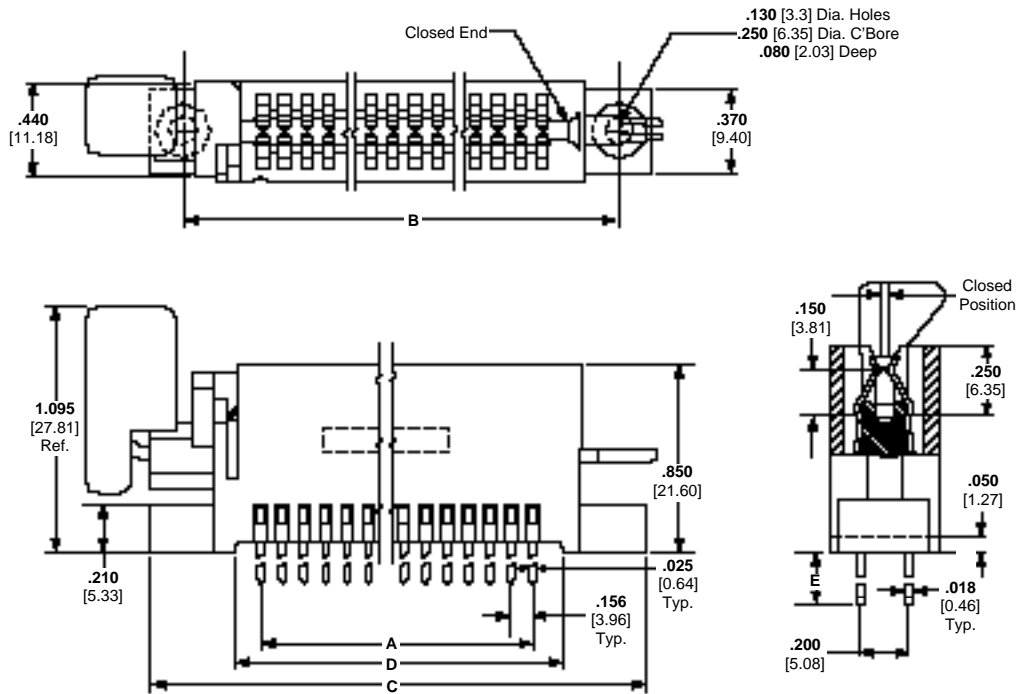

No. of Dual Positions	Dimensions					Part Numbers		
	A	B	C	D	E*	Open One End <sup>1</sup>	Open Both Ends <sup>1</sup>	Closed Both Ends
22	3.276	4.088	4.388	3.588	.125	531025-3	—	—
	83.21	103.83	111.46	91.14	.160	531025-9	—	531007-9
36	5.460	6.272	6.572	5.772	.160	—	1-531026-1	—
	138.68	159.31	166.93	146.61	.160	—	—	—
43	6.552	7.364	7.664	6.864	.125	531025-6	—	—
	166.42	187.05	194.67	174.35	.125	531025-6	—	—

\*Metric equivalents in millimeters for post lengths E are .125 = [3.18]; .160 = [4.06].

<sup>1</sup>Recognized under the Component Program of Underwriters Laboratories Inc.

**Notes:** 1. Connector with card slot open one end is shown for illustration purposes.  
 2. Other connector sizes can be made available, consult Tyco Electronics.

**Accessories**

**Dust Covers**

**Material:** Rigid vinyl, black

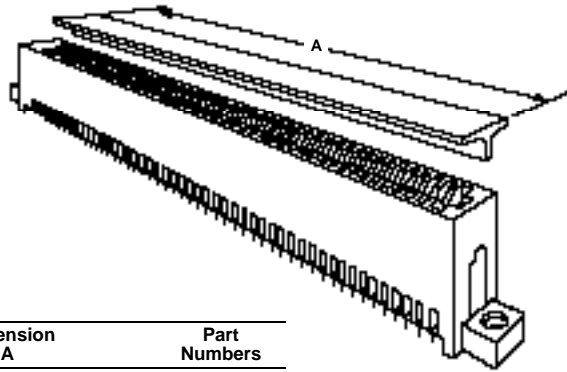

Dimension A	Part Numbers
11.050 280.67	531863-2
48.000 1219.20	531863-1

**Note:** Other lengths can be made available upon request, consult Tyco Electronics.

**Cam Rods with Boot**

**Material:**

**Cam Rod**—Stainless steel

**Boot**—Glass-filled polyester, yellow

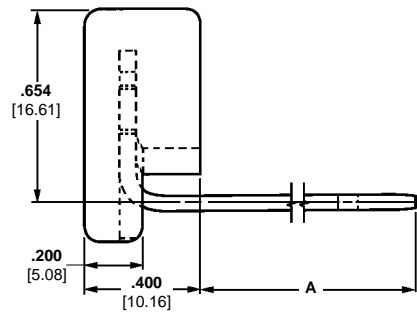
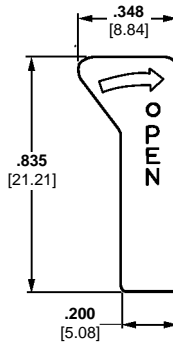

Dimension A	Part Numbers
3.185 80.90	650083-1
3.705 94.11	650083-2
4.470 113.54	650083-3
5.285 134.24	650083-4
5.900 149.86	650083-6
5.975 151.77	532563-7

Dimension A	Part Numbers
6.385 162.18	650083-7
6.985 177.42	650083-8
7.485 190.12	650083-9
7.725 196.22	1-532563-0
8.320 211.34	1-650083-7

**Note:** Other lengths can be made available upon request, consult Tyco Electronics.

**Cam Rods without Boot**

**Material:** Stainless steel

Solder Type Board-to-Board Connectors

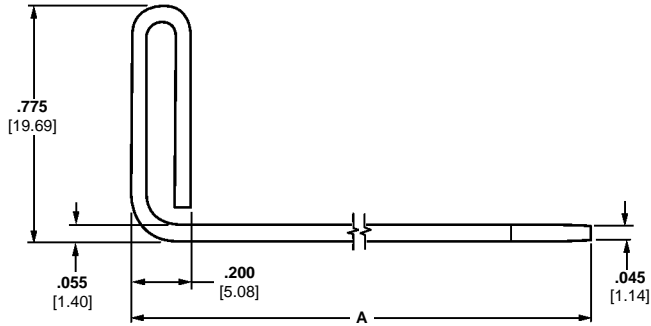
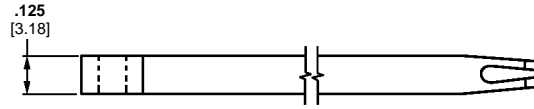

Dimension A	Part Numbers
2.200 55.88	2-531004-8
2.700 68.58	2-531004-9
3.300 83.82	3-531004-0
4.750 120.65	531004-4
5.000 127.00	1-531004-4
5.500 139.70	531004-6

Dimension A	Part Numbers
6.000 152.40	531004-7
6.250 158.75	1-531004-6
6.750 171.45	1-531004-7
8.250 209.55	3-531004-2
12.500 317.50	2-531004-0

**Note:** Other lengths can be made available upon request, consult Tyco Electronics.

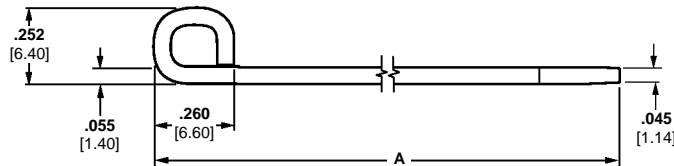
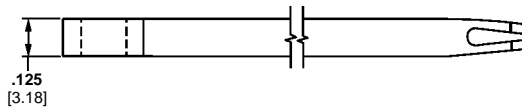

Dimension A	Part Numbers
3.380 85.85	645293-3
4.50 114.30	645293-8
5.200 132.08	645293-6
6.90 175.30	645293-7
13.120 333.25	645293-5

**Note:** Other lengths can be made available upon request, consult Tyco Electronics.

**Recommended PC Board Hole Layouts**

**Mother Board Hole Layout, Vertical Through-Board Connectors**

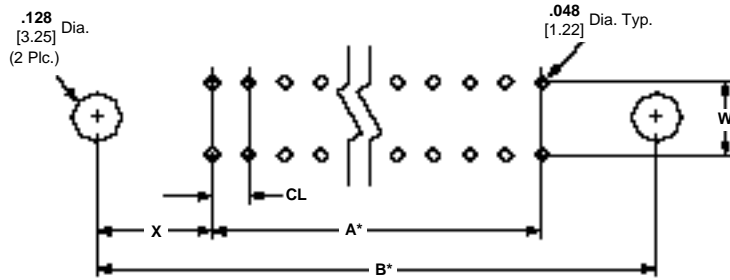

\*Refer to individual connector specifications.

CL	W	X
.100 2.54	.200 5.08	.350 8.89
.125 2.18	.250 6.35	.375 9.53
.156 3.96	.200 5.08	.406 10.31

**Mother Board Hole Layout, Right-Angle Through-Board Connectors**

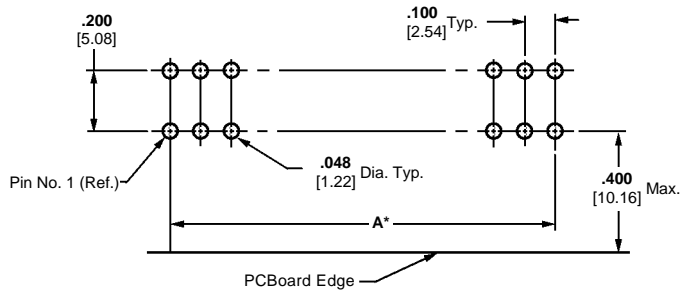

\*Refer to individual connector specifications.

**Recommended PC Board Edge Pattern**

**Daughter Board Edge Pattern**

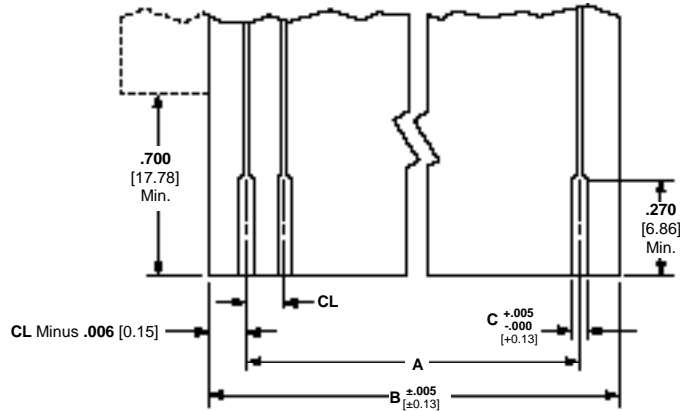

No. of Dual Positions	CL = .100 [2.54] C = .050 [1.27]		CL = .125 [3.18] C = .078 [1.98]		CL = .156 [3.96] C = .094 [2.39]	
	A	B	A	B	A	B
22	2.100 53.34	2.288 58.12	—	—	3.267 83.21	3.576 90.83
25	2.400 60.96	2.588 65.74	—	—	—	—
28	2.700 68.58	2.888 73.36	3.375 85.73	3.613 91.77	—	—
30	—	—	3.625 92.08	3.863 98.12	—	—
31	3.000 76.20	3.188 80.98	—	—	—	—
36	3.500 88.90	3.688 93.68	—	—	5.460 138.68	5.760 146.30
40	3.900 99.06	4.088 103.84	4.875 123.83	5.113 129.87	—	—
43	4.200 106.68	4.388 111.46	—	—	6.552 166.42	6.852 174.04
50	4.900 124.46	5.088 129.24	—	—	—	—
60	5.900 149.86	6.088 154.64	—	—	—	—
65	6.400 162.56	6.588 167.34	—	—	—	—

**Special Application**

**Tandem Application**



**Note:** Contact Tyco Electronics for information concerning special tandem connectors.

**Linear ZIF Connectors**

**Product Facts**

- Minimizes force needed to install and remove printed circuit boards
- Available in lever and bell crank styles
- Lever styles allow side and top card entry
- Wiping action contacts enhance electrical properties
- Contacts on .100 x .100 [2.54 x 2.54] or .125 x .125 [3.18 x 3.18] centers
- .025 [0.64] square posts
- Accepts PC boards from .054 to .070 [1.37 to 1.78] in thickness
- Normally closed design leaves springs in relaxed position
- 50 to 175 dual positions available on .100 [2.54] centerline connectors and 40 to 140 dual positions available on .125 [3.18] centerline connectors



**Performance Specifications**

**Current vs. Temperature Rise\*:**  
3 amperes at 30°C

**Operating Temperature:**  
-65°C to +85°C

**Contact Resistance:**  
16 milliohms max.

**Durability:** Tested to 250 cycles  
(board-to-contact actuation)

AMP Linear Zero Insertion Force (ZIF) PC Board Edge Connectors are available in both lever and bell crank actuated styles and can be provided as panel assemblies, separate housings and contacts or as pre-assembled with solder post terminals.

Panel assemblies include a housing with ACTION PIN press-fit solderless contacts mounted on an epoxy board for rack application. Separate housing assemblies and ACTION PIN contacts allow customer assembly. These can be mounted as close as .625 [15.88]. More design latitude for high density application is provided by the side entry lever-type connector, permitting use of all sides of the PC board for edge-type I/O connections (see page 133). Where solder applications are

required, Tyco Electronics has a line of preassembled connectors with tin-plated solder terminals. All these configurations are available in a broad range of sizes.

With ZIF style connectors, intermittencies can occur if a contact comes to rest on a piece of foreign matter (dust and dirt particles) found on PC boards. To decrease the probability of this happening, all connectors have been designed to include a wiping contact which produces a wiping action. This action, produced by the geometry and bending movements of the beam, pushes aside debris and allows for good electrical connection by cleaning the actual point of contact.

In addition, all connectors have removable wings which make it possible to repair or replace damaged cam rails, handles, contacts

and housing modules without removing the entire housing assembly from the board.

\*Consult Tyco Electronics engineering when paralleling contacts for power applications.



**Linear ZIF Connectors, .100 x .100 [2.54 x 2.54] Centerline**

**Housing with Solder Posts**

**Lever Style, Side Entry**

**Material and Finish:**

**Housing**—Glass-filled polyester, black

**Contacts**—Copper alloy 725, plated .000015 [0.00038] min. gold per MIL-G-45204 in contact area; .000100 [0.00254] min. tin-lead on post with entire contact underplated .000050 [0.00127] min. nickel per QQ-N-290

**Related Product Data:**

**Daughter PC Board**—.054-.070 [1.37-1.78] thick

**Performance Specifications**—page 83

**PC Board Hole Layout and Edge Pattern**—page 88

**Special Application**—page 96



**Technical Documents:**

(pages 186, 187):

Product Specification  
108-14015

Application Specification  
114-26003

Instruction Sheets 408-2995,  
408-2999, 408-6915

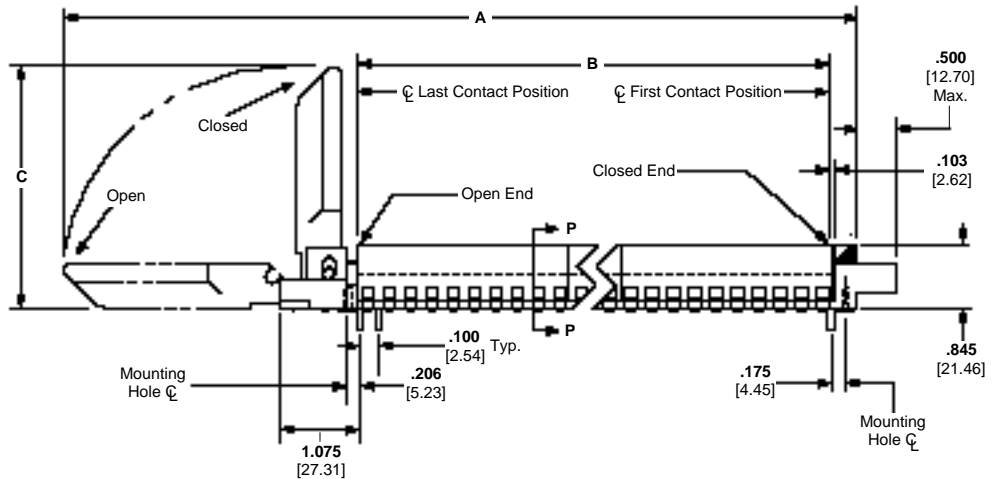
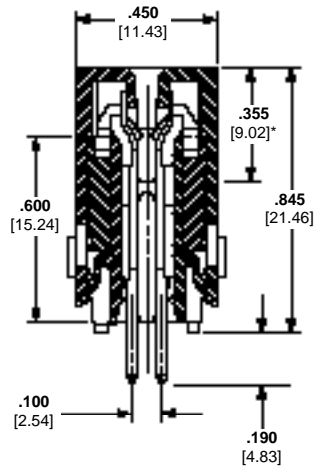

\*Card slot depth.

No. of Dual Positions	Dimensions			Part Number
	A	B	C	
35	6.113 155.27	3.400 86.36	2.000 50.80	645135-2
80	11.613 294.97	7.900 200.66	3.000 76.20	1-645135-1
100	13.613 345.77	9.900 251.46	3.000 76.20	1-645135-5

**Note:** Other connector sizes can be made available, consult Tyco Electronics.

**Linear ZIF Connectors, .100 x .100 [2.54 x 2.54] Centerline** (Continued)

Solder Type Board-to-Board Connectors

**Panel Assembly**

**Material and Finish:**

**Housing**—Glass-filled polyester, black

**Contacts**—Copper alloy 725, plated .000015 [0.00038] gold per MIL-G-45204 in contact area; .000001 [0.00003] min. gold flash per MIL-G-45204 on post with entire contact under-plated .000050 [0.00127] nickel per QQ-N-290

**Related Product Data:**

**Daughter PC Board**—.054-.070 [1.37-1.78] thick

**Performance Specifications**—page 83

**PC Board Hole Layout and Edge Pattern**—page 88

**ACTION PIN Contacts**—pages 88, 94

**Tooling**—page 95

**Special Application**—page 96

**Technical Documents:**

(pages 186, 187):

Product Specification  
108-14015

Application Specification  
114-26003

Instruction Sheets 408-2995,  
408-2999, 408-6915

**Lever Style, Side Entry**

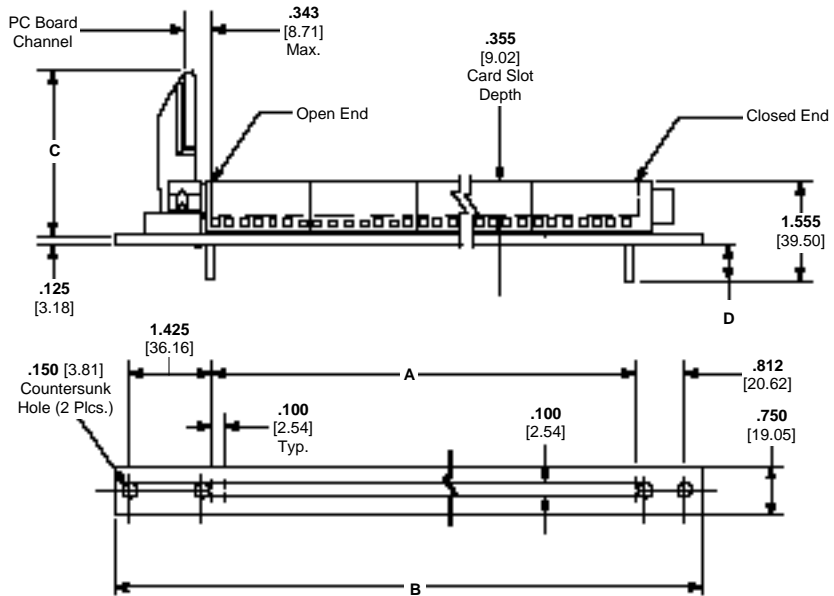

No. of Dual Positions	Dimensions				Part Numbers
	A	B	C	D	
75	7.400 251.46	10.125 320.68	3.000 76.20	.615 15.62	1-645145-0
100	9.900 251.46	12.625 320.68	3.000 76.20	.615 15.62	1-645145-5
130	12.900 251.46	15.625 320.68	3.000 76.20	.615 15.62	2-645145-1
140	13.900 353.06	16.625 422.28	3.000 76.20	.615 15.62	2-645145-3
150	14.900 251.46	17.625 320.68	3.000 76.20	.615 15.62	2-645145-5
160	15.900 403.86	18.625 473.07	3.000 76.20	.615 15.62	2-645145-7
160	15.900 403.86	18.625 473.07	3.000 76.20	.455 11.56	147400-1

**Note:** Other connector sizes can be made available, consult Tyco Electronics.

**Panel Assembly**

**Lever Style, Top Entry**

**Material and Finish:**

**Housing**—Glass-filled polyester, black

**Contacts**—Copper alloy 725, plated .000015 [0.00038] gold per MIL-G-45204 in contact area; .000001 [0.00003] min. gold flash per MIL-G-45204 on post with entire contact under-plated .000050 [0.00127] nickel per QQ-N-290

**Related Product Data:**

**Daughter PC Board**—.054-.070 [1.37-1.78] thick

**Performance Specifications**—page 83

**PC Board Hole Layout and Edge Pattern**—page 88

**ACTION PIN Contacts**—pages 88, 94

**Tooling**—page 95

**Technical Documents:**

(pages 186, 187):

Product Specifications  
108-14015, 108-26003

Application Specification  
114-26003

Instruction Sheets 408-2995,  
408-2999, 408-6915

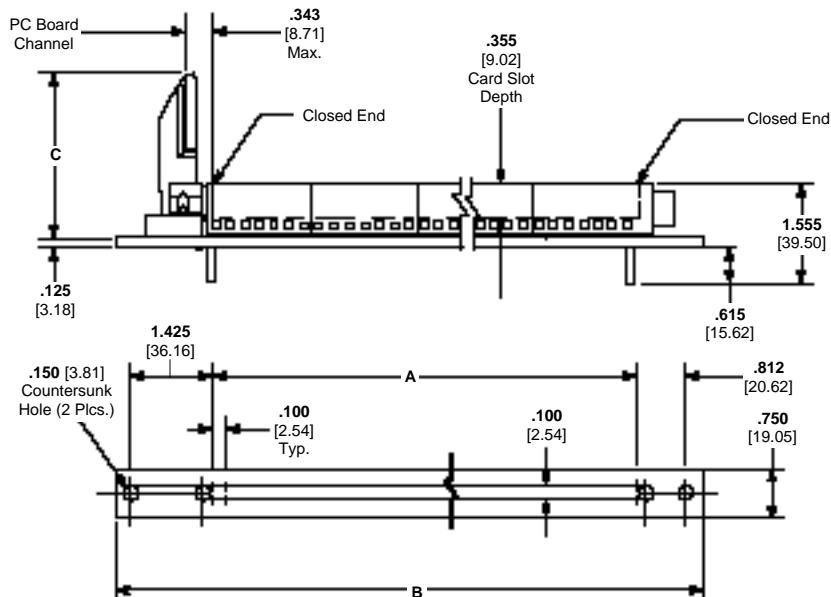
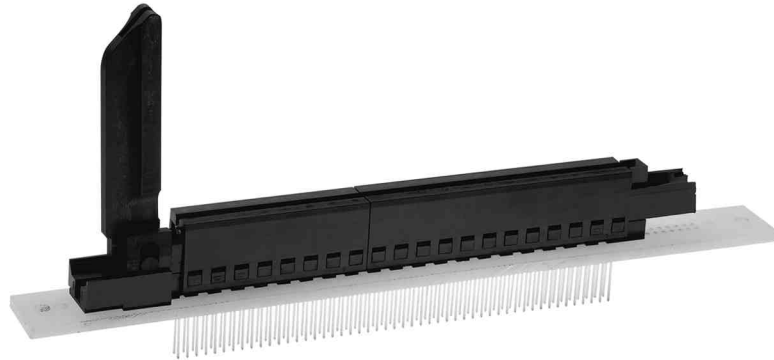

No. of Dual Positions	Dimensions			Part Numbers
	A	B	C	
110	10.900 276.86	13.625 346.08	3.000 76.20	1-645147-7
120	11.900 302.26	14.625 371.48	3.000 76.20	1-645147-9

**Note:** Other connector sizes can be made available, consult Tyco Electronics.

**Linear ZIF Connectors, .100 x .100 [2.54 x 2.54] Centerline** (Continued)

**Housing**

**Material:** Glass-filled polyester, black

**Related Product Data:**

**Daughter PC Board**—.054-.070 [1.37-1.78] thick

**Mounting Screws**—Customer supplies, must be applied before opening connector

**Performance Specifications**—page 83

**PC Board Hole Layout and Edge Pattern**—page 88

**ACTION PIN Contacts**—pages 88, 94

**Tooling**—page 95

**Special Application**—page 96

**Technical Documents:**

(pages 186, 187):

Product Specifications  
108-14015, 108-26003

Application Specification  
108-26003

Instruction Sheets 408-2995,  
408-2999, 408-6915

**Lever Style, Side Entry**

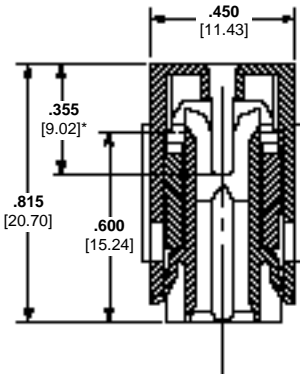
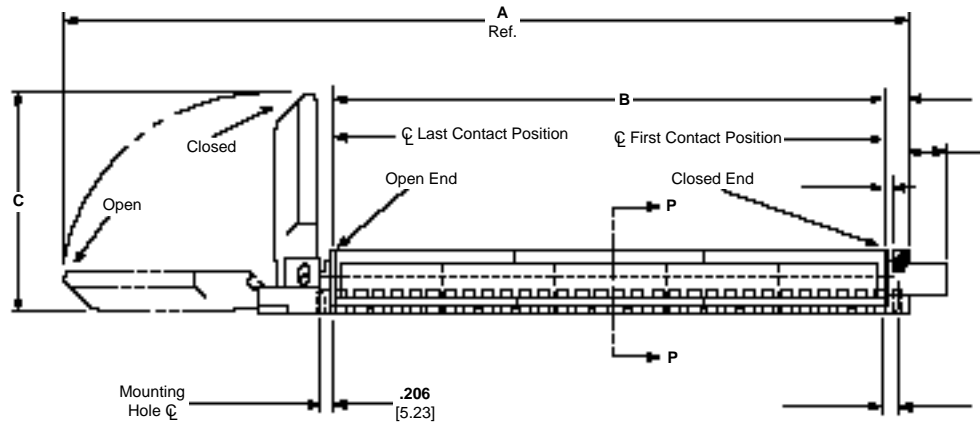

Section P-P

\*Card slot depth.

No. of Dual Positions	Dimensions			Part Numbers
	A	B	C	
50	7.613 193.37	4.900 124.46	2.000 50.80	645115-5
75	11.113 282.27	7.400 187.96	3.000 76.20	1-645115-0
80	11.613 294.97	7.900 200.66	3.000 76.20	1-645115-1
100	13.613 345.77	9.900 251.46	3.000 76.20	1-645115-5
110	14.613 371.17	10.900 276.86	3.000 76.20	1-645115-7 3-645115-2
115	15.113 383.87	11.400 289.56	3.000 76.20	1-645115-8
125	16.113 409.27	12.400 314.96	3.000 76.20	2-645115-0
130	16.613 421.97	12.900 327.66	3.000 76.20	2-645115-1
140	17.613 447.37	13.900 353.06	3.000 76.20	2-645115-3
160	19.613 498.17	15.900 403.86	3.000 76.20	3-645115-3
175	21.113 536.27	17.400 441.96	3.000 76.20	3-645115-0

**Note:** Other connector sizes can be made available, consult Tyco Electronics.

**ACTION PIN Contacts with Wiping Feature,  
.100 [2.54] Centerline**

**Material and Finish:**

Copper alloy 725, plated .000015 [0.00038] gold per MIL-G-45204 in contact area; .000001 [0.00003] min. gold flash per MIL-G-45204 on post with entire contact underplated .000050 [0.00127] nickel per QQ-N-290

**Related Product Data:**

**Performance Specifications—**  
page 83

**ACTION PIN Contact Description and Application Specification—**  
page 94

**Tooling—**page 95

**Technical Documents:**

(pages 186, 187):  
Instruction Sheet 408-2665

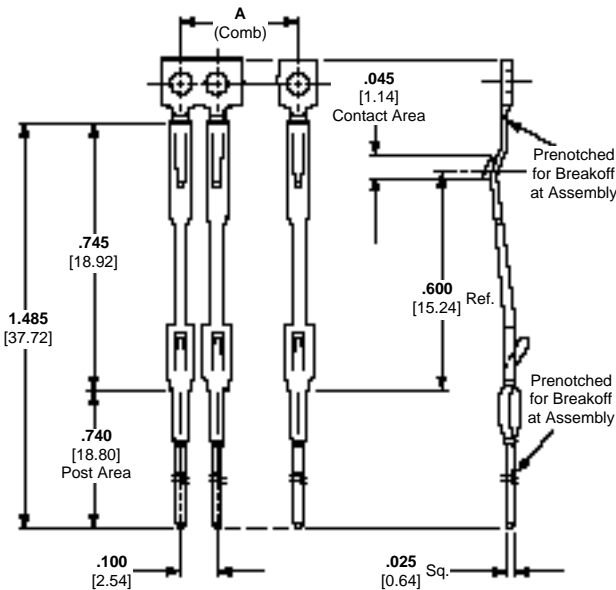

**Contact Combs**

Number of Contacts Per Comb*	Dimension A		Part Number
	Inches	Millimeters	
55	5.400	137.16	4-119311-1

\*At least two (2) contact combs required per housing.  
**Note:** Other sizes can be made available, consult Tyco Electronics.

**Reeled Contacts**

Number of Contacts Per Reel	Part Number
35,000	119196-6

**Note:** Other plating combinations and thicknesses can be made available, consult Tyco Electronics.

**Recommended PC Board Hole Layout and Edge Pattern,  
.100 [2.54] Centerline**

**Mother Board Hole Layout**

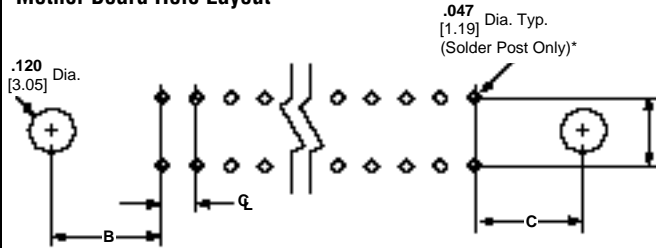

\*For ACTION PIN post hole diameter, see page 94.

Connector Style	Dimensions			
	CL	A	B	C
Lever	.100 2.54	.100 2.54	.206 5.23	.175 4.45

**Daughter Board Edge Pattern**

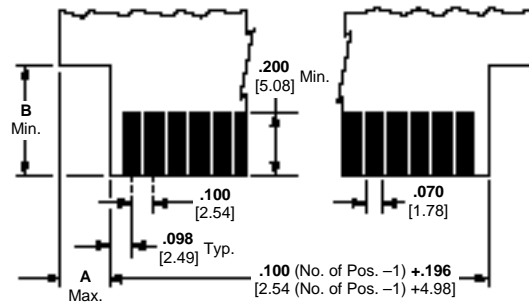

Connector Style	Entry Style	Dimensions	
		A	B
Lever	Side	.240 6.10	—
	Top	.240 6.10	.320 8.13

**Linear ZIF Connectors, .125 x .125 [3.18 x 3.18] Centerline**

**Panel Assembly**

**Lever Style, Side Entry**

**Material and Finish:**

**Housing**—Glass-filled polyester, black

**Contacts**—Copper alloy 725, plated .000015 [0.00038] gold per MIL-G-45204 in contact area; .000001 [0.00003] min. gold flash per MIL-G-45204 on post with entire contact under-plated .000050 [0.00127] nickel per QQ-N-290

**Related Product Data:**

**Daughter PC Board**—.054-.070 [1.37-1.78] thick

**Performance Specifications**—page 83

**PC Board Hole Layout and Edge Pattern**—page 93

**ACTION PIN Contacts**—pages 93, 94

**Tooling**—page 95

**Special Application**—page 96

**Technical Documents:**

(pages 186, 187):

Instruction Sheets 408-2995, 408-6915, 408-6916

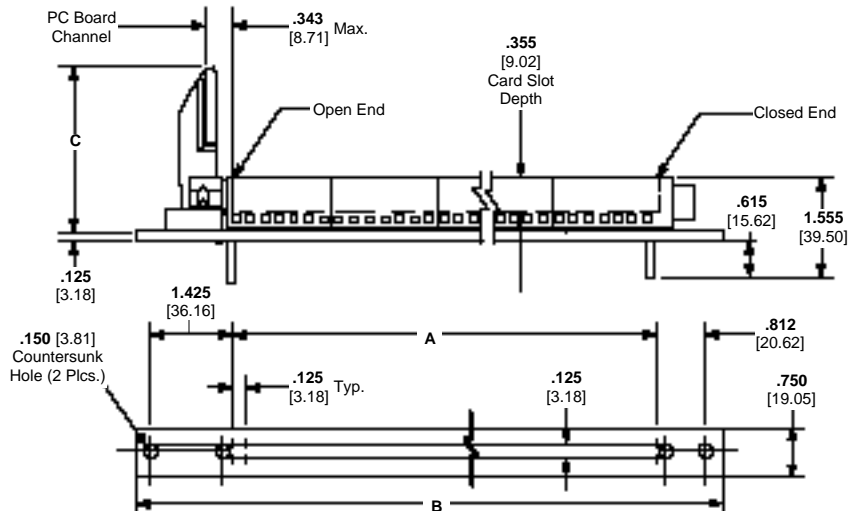

No. of Dual Positions	Dimensions			Part Numbers
	A	B	C	
40	4.875 123.83	7.625 193.68	2.000 50.80	645146-5
56	6.875 174.63	9.625 244.48	3.000 76.20	645146-9
60	7.375 187.32	10.125 257.17	3.000 76.20	1-645146-0
72	8.875 225.43	11.625 295.28	3.000 76.20	1-645146-3
84	10.375 250.83	13.125 320.68	3.000 76.20	1-645146-6
124	15.375 390.53	18.125 460.38	3.000 76.20	2-645146-6

**Note:** Other connector sizes can be made available, consult Tyco Electronics.



**Panel Assembly**

**Bell Crank Style, Top Entry**

**Material and Finish:**

**Housing**—Glass-filled polyester, black

**Contacts**—Copper alloy 725, plated .000015 [0.00038] gold per MIL-G-45204 in contact area; .000001 [0.00003] min. gold flash per MIL-G-45204 on post with entire contact under-plated .000050 [0.00127] nickel per QQ-N-290

**Related Product Data:**

**Daughter PC Board**—.054-.070 [1.37-1.78] thick

**Performance Specifications**—page 83

**PC Board Hole Layout and Edge Pattern**—page 93

**ACTION PIN Contacts**—pages 93, 94

**Tooling**—page 95

**Technical Documents:**

(pages 186, 187):

Instruction Sheets 408-2995, 408-6915, 408-6916

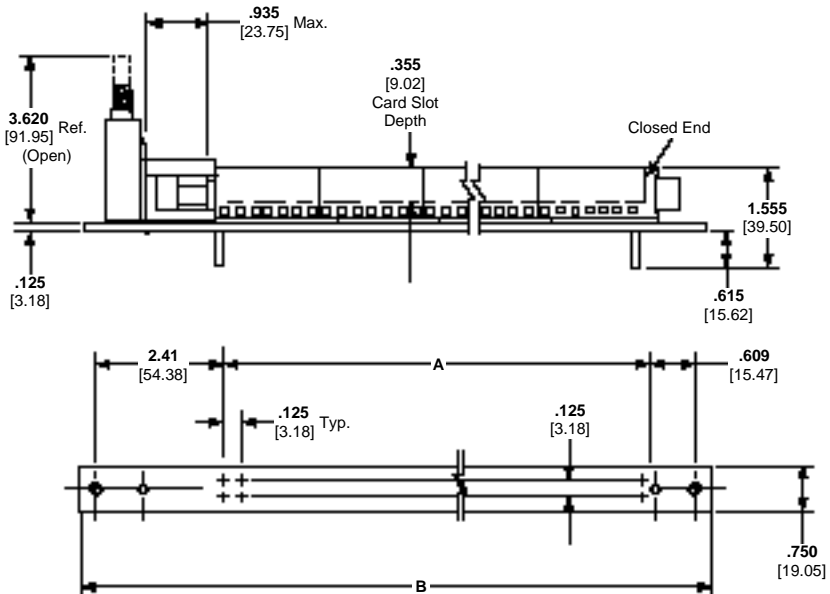

No. of Dual Positions	Dimensions		Part Numbers
	A	B	
60	7.375 187.33	10.625 269.88	1-645149-0
80	9.875 250.82	13.125 333.38	1-645149-5
112	13.875 352.43	17.125 434.98	2-645149-3
140	17.375 441.33	20.625 523.88	3-645149-0

**Note:** Other connector sizes can be made available, consult Tyco Electronics.

**Linear ZIF Connectors, .125 x .125 [3.18 x 3.18] Centerline** (Continued)

**Housing**

**Material:** Glass-filled polyester, black

**Related Product Data:**

**Daughter PC Board**—.054-.070 [1.37-1.78] thick

**Mounting Screws**—Customer supplied, must be applied before opening connector

**Performance Specifications**—page 83

**PC Board Hole Layout and Edge Pattern**—page 93

**ACTION PIN Contacts**—pages 93, 94

**Tooling**—page 95

**Special Application**—page 96

**Lever Style, Side Entry**



**Technical Documents:**

(pages 186, 187):

Instruction Sheets 408-2995, 408-6915, 408-6916

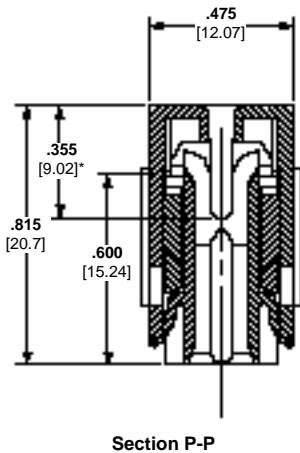

\*Card slot depth.

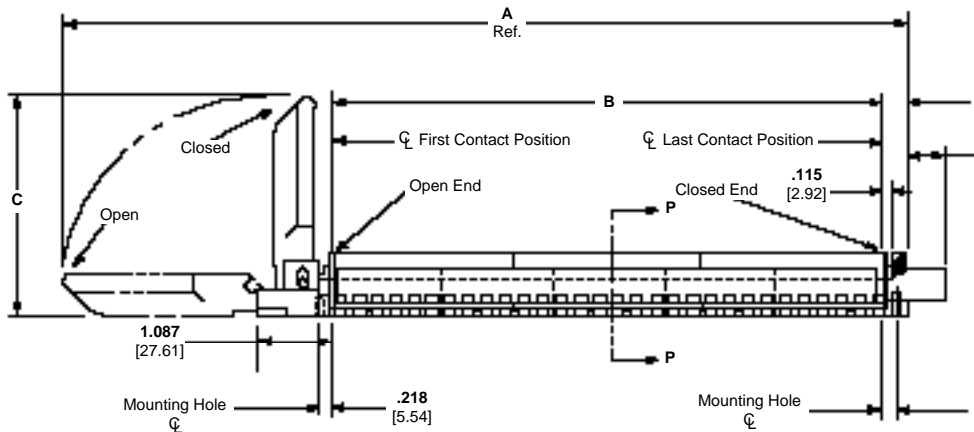

No. of Dual Positions	Dimensions			Part Number
	A	B	C	
84	14.112 358.44	10.375 263.52	3.000 76.20	1-645116-6
100	16.112 409.24	12.375 314.33	3.000 76.20	2-645116-0
112	17.612 447.34	15.775 400.68	3.000 76.20	2-645116-3
124	19.112 485.44	17.275 438.78	3.000 76.20	2-645116-6

**Note:** Other connector sizes can be made available, consult Tyco Electronics.

**Housing**

**Bell Crank Style, Top Entry**

**Material:** Glass-filled polyester, black

**Related Product Data:**

**Daughter PC Board**—.054-.070 [1.37-1.78] thick

**Mounting Screws**—Customer supplied, must be applied before opening connector

**Performance Specifications**—page 83

**PC Board Hole Layout and Edge Pattern**—page 93

**ACTION PIN Contacts**—pages 93, 94

**Tooling**—page 95

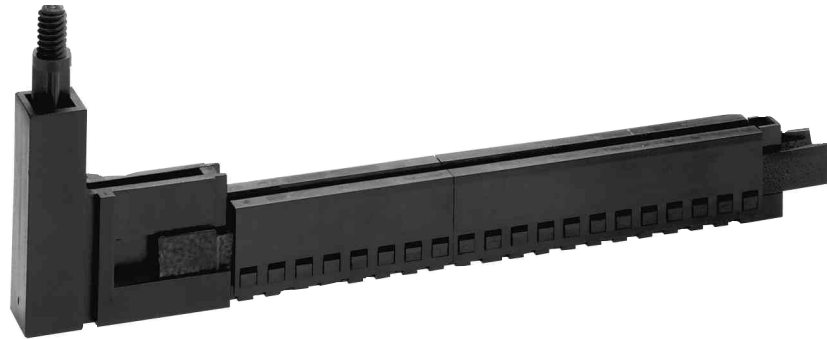

**Technical Documents:**

(pages 186, 187):

Instruction Sheets 408-2995, 408-6915, 408-6916

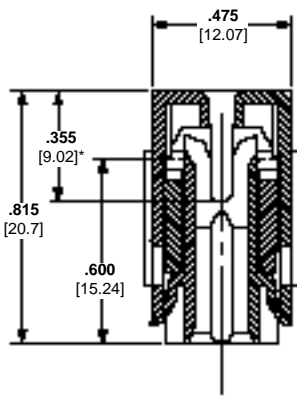

Section P-P

\*Card slot depth.

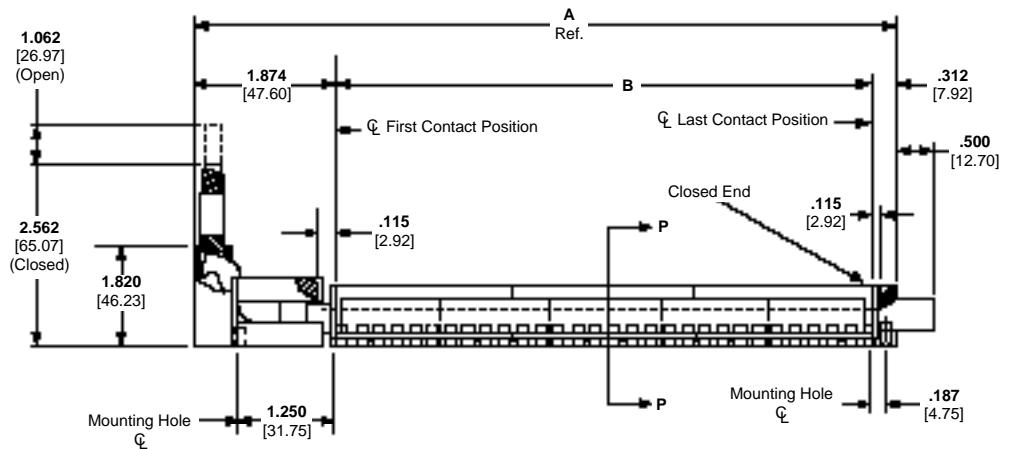

No. of Dual Positions	Dimensions		Part Numbers
	A	B	
52	<b>8.562</b> 217.47	<b>6.375</b> 161.93	645142-8
60	<b>9.562</b> 242.87	<b>7.375</b> 187.32	1-645142-0
80	<b>13.125</b> 333.37	<b>9.875</b> 250.82	1-645142-5
112	<b>16.062</b> 407.97	<b>13.875</b> 352.43	2-645142-3

**Note:** Other connector sizes can be made available, consult Tyco Electronics.

**ACTION PIN Contacts with Wiping Feature, .125 [3.18] Centerline**

**Material and Finish:**

Copper alloy 725, plated .000015 [0.00038] gold per MIL-G-45204 in contact area; .000001 [0.00003] min. gold flash per MIL-G-45204 on post with entire contact underplated .000050 [0.00127] nickel per QQ-N-290

**Related Product Data:**

**Performance Specifications**—page 83

**ACTION PIN Contact Description and Application Specification**—page 94

**Tooling**—page 95

**Technical Documents:**

(pages 186, 187):  
Instruction Sheet 408-2665

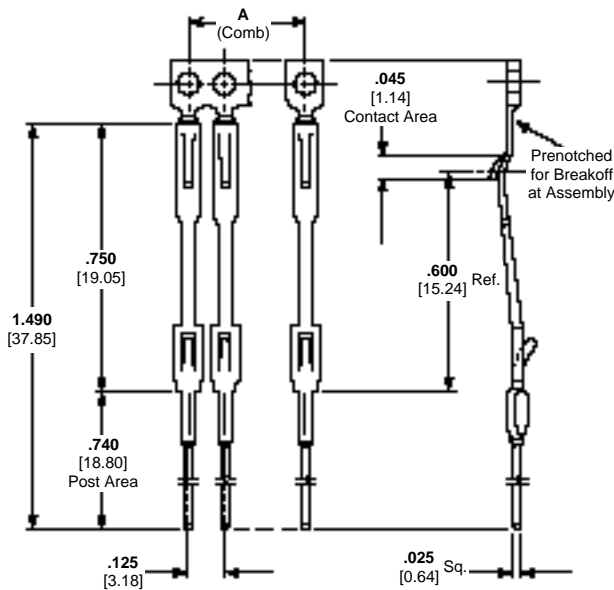

**Contact Combs**

Number of Contacts Per Comb*	Dimension A	Part Number
56	6.875 174.63	1-119950-2

\*At least two (2) contact combs required per housing.

**Note:** Other sizes can be made available, consult Tyco Electronics.

**Recommended PC Board Hole Layout and Edge Pattern, .125 [3.18] Centerline**

**Mother Board Hole Layout**

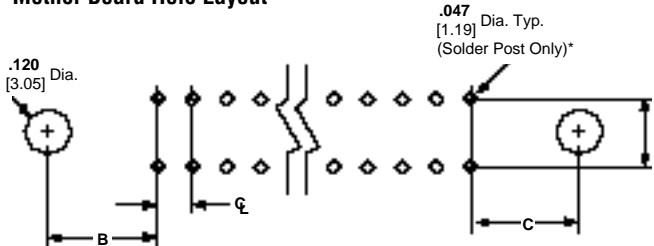

\*For ACTION PIN post hole diameter, see page 94.

Connector Style	Dimensions			
	ϕ	A	B	C
Lever	.125 3.18	.125 3.18	.218 5.54	.187 4.75
Bell-Crank	.125 3.18	.125 3.18	1.250 31.75	.187 4.75

**Daughter Board Edge Pattern**

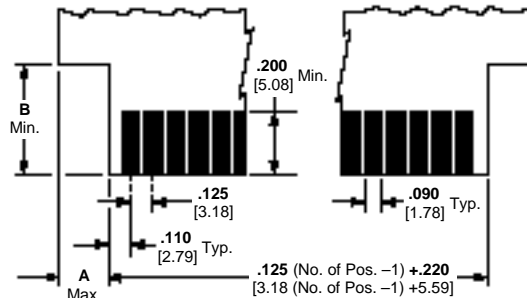

Connector Style	Entry Style	Dimensions	
		A	B
Lever	Side	.240 6.10	—
	Top	.240 6.10	.320 8.13
Bell-Crank	Top	.775 19.68	.600 15.24

**AMP ACTION PIN  
Press-Fit Contacts**

Solder Type Board-to-Board  
Connectors

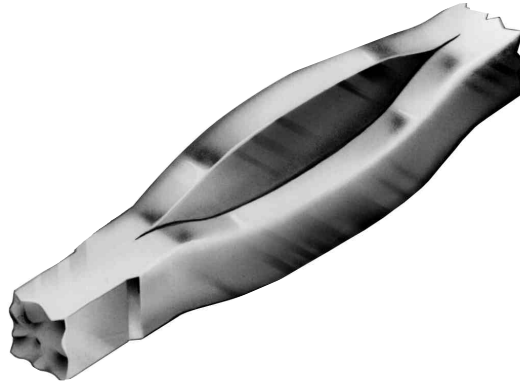

ACTION PIN contacts provide a reliable press-fit connection. Localized pressure in the interface area entails oxide break-through and helps prevent corrosion in the harshest environments to provide a reliable connection virtually every time. Also, radial and axial distortion are controlled to meet today's standards for multilayer board applications.

**PC Board Thickness**

ACTION PIN contacts are designed for use in a variety of PC board thicknesses. However, certain ACTION PIN contacts are to be used in specific ranges of board thicknesses. To promote optimum performance, the recommended board thicknesses provided with the connector being used must be followed.

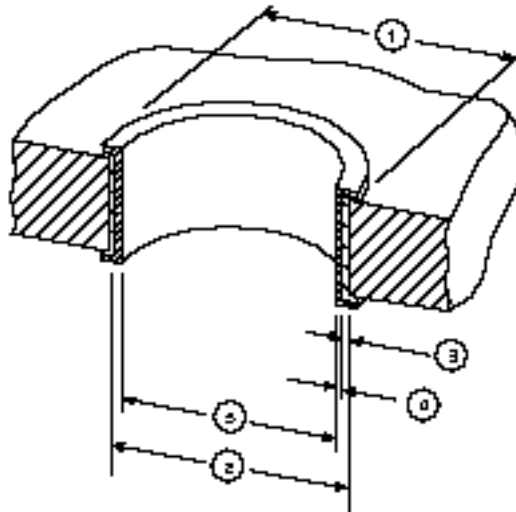

- ① Annular Ring (See Note)
- ② Drilled Hole
- ③ Copper Thickness
- ④ Tin-Lead Thickness
- ⑤ Plated Through-Hole

**ACTION PIN Contact/PC Board Applications**

Connector Type	ACTION PIN Contact Material Thickness	Drilled Hole Diameter <sup>②</sup>	Plating Thicknesses		Plated Through-Hole Diameter <sup>⑤</sup>	Radial Hole Distortion	
			Copper <sup>③*</sup>	Tin-Lead <sup>④</sup>		Average	Maximum
Linear ZIF	.025 0.64	.0453±.001 1.151±0.03	.001-.003 0.03-0.08	.0003 0.008 Min.	.037-.043 0.94-1.09	Not Specified	Not Specified

\*Maximum hardness of copper layer is 150 Knoop.

**Note:** Recommended annular ring diameter is hole diameter plus .020 [0.51].

**Linear ZIF Connectors** (Continued)

**Tooling**

Assembly tooling is not required except when using connectors with ACTION PIN contacts. ACTION PIN contact assembly requires an arbor-style bench tool with a capacity of 40 lb [178 N] per contact, a support fixture, contact applicator, carrier removal tool and housing assembly tool.

Typical procedure is to place a PC board on the support fixture, insert contact combs into the printed circuit board with the contact applicator and seat with the arbor tool. Next, remove the carrier strip from the contact combs with the carrier break-off tool. Place the housing over the contacts with the housing assembly tool, and repeat the entire process until the board is complete.

**.100 x .100 [2.54 x 2.54] Centerline Connectors**

No. of Dual Positions	T-Bar Applicator	Carrier Removal Tool	Housing Assembly Tool	Housing Removal Tool	Wing Removal/Replacement Tool	Housing Insertion Tool	Contact Replacement Tools	
							With Housing	Without Housing
50	266267-4	265924-4	313136-1					
80	266267-3	265924-4	313136-2					
100	266267-4	265924-4						
110	266267-5	265924-4	313136-3					
115	266267-5	265924-4		313256-1	266233-1	266264-1	266235-1	3-265871-2
120	266267-5	265924-4						
125	266267-4	265924-4	313136-4					
140	266267-4	265924-4						
175	266267-5	265924-4	313136-5					

**.125 x .125 [3.18 x 3.18] Centerline Connectors**

No. of Dual Positions	T-Bar Applicator	Carrier Removal Tool	Housing Assembly Tool	Housing Removal Tool	Wing Removal/Replacement Tool	Housing Insertion Tool	Contact Replacement Tools	
							With Housing	Without Housing
40	313139-1	265924-4	313136-1					
52	313139-2	265924-6						
56	313139-2	265924-6	313136-2					
60	313139-2	265924-7						
72	313139-3	265924-4		313256-1	266233-1	266264-1	266235-1	3-265871-2
84	313139-2	265924-5	313136-3					
112	313139-2	265924-7	313136-4					
124	313139-2	265924-5						
140	313139-2	265924-5	313136-5					



**Linear ZIF Connectors** (Continued)**Special Application**

Use Linear and Rotary ZIF Connectors as Card Guides to access more sides of the Daughter Board.

