

Features

- 9 mm Round / Single-Turn / Cermet Industrial / Open Frame
- Both sides adjust
- Horizontal and vertical mounting styles
- Dust resistant/splash resistant covers
- PC board stand-offs
- Lead free terminals

■ RoHS compliant*

TC89 - 9 mm Round Trimpot® Trimming Potentiometer

Electrical Characteristics

Standard Resistance Range 100 ohms to 1 megohm
 (see standard resistance table)
 Resistance Tolerance ±20 % std.
 Absolute Minimum Resistance
 ≤500 Ohms 10 ohms max.
 >500 Ohms 2 % max. of TR
 Contact Resistance Variation .. 5 % max.
 Resolution Infinite
 Adjustment Angle 270 ° ±15 °

Environmental Characteristics

Power Rating (250 VDC max.)
 70 °C 0.5 watt
 Temperature Range ... -30 °C to +100 °C
 Temperature Coefficient ... ±250 ppm/°C
 Humidity 95 % RH
 TRS ±5 %
 Load Life..... 500 hours @ 70 °C
 TRS ±5 %
 Rotational Cycling 50 cycles
 TRS ±10 %

Physical Characteristics

Torque..... 50-350 gf-cm
 Mechanical Angle 270 ° ±15 °
 Marking..... Part marking code
 Standard Packaging..... 500 pcs./bag
 Adjustment Tool..... H-90
 Aqueous cleaning not recommended

How To Order

TC89 P - 1 - 103

Model _____
 Style _____
 Standard Product Indicator _____
 Resistance Code _____

Standard Resistance Table

Resistance (Ohms)	Resistance Code
100	101
200	201
500	501
1,000	102
2,000	202
5,000	502
10,000	103
20,000	203
50,000	503
100,000	104
200,000	204
500,000	504
1,000,000	105

Popular distribution resistance values listed in boldface.

10/09

*RoHS Directive 2002/95/EC Jan 27 2003 including Annex.
 "Trimpot" is a registered trademark of Bourns, Inc.
 Specifications are subject to change without notice.
 Customers should verify actual device performance in their specific applications.

Product Dimensions

Top Adjust
TC89P

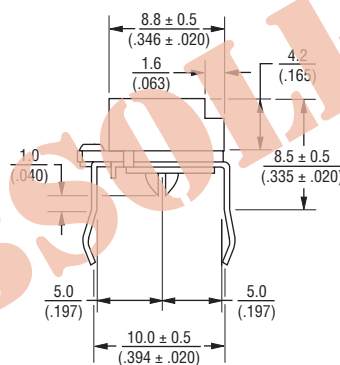
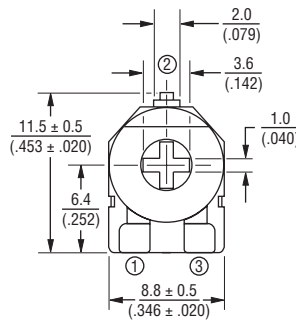

Packaging Specifications

Side Adjust
TC89W

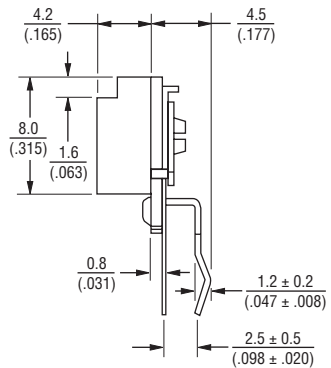
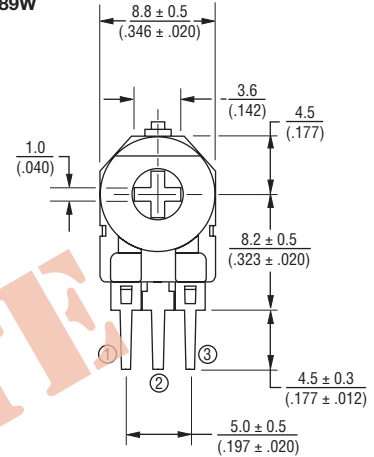

Suggested PCB Layout

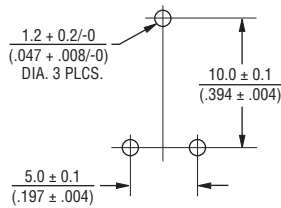

Suggested PCB Layout

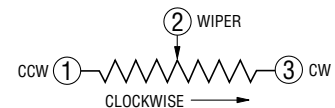
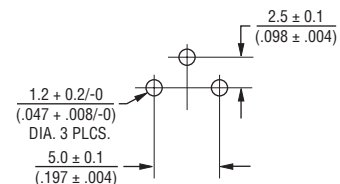

DIMENSIONS: $\frac{\text{MM}}{\text{(INCHES)}}$

TOLERANCES: ± $\frac{0.25}{(.010)}$ EXCEPT WHERE NOTED