

Surface Mount Cermet Trimmers (single turn)

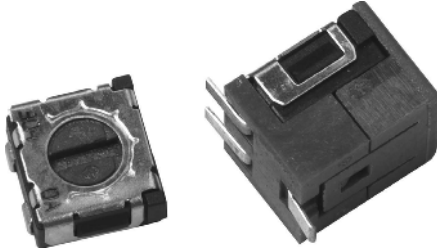

FEATURES

- Lead (Pb)-free soldering, Cadmium-free
- Wide variety (7 types) to choose from
- Automatic mounting is possible (Taping)
- Flow/reflow soldering is possible
- Sealed construction (Washable)
- Stopper structure prevents terminal pin from being open
- Cross slot totor suitable for automatic adjustment
- RoHS compliant



DIMENSIONS in millimeters

RECOMMENDED P.C.B. PAD OUTLINE DIMENSIONS

ST-4A, 4EA

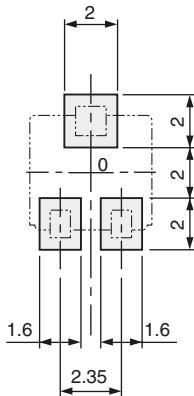

ST-4B, 4EB

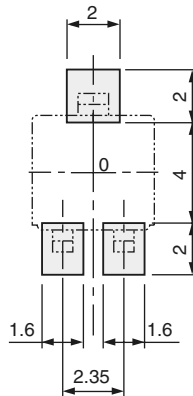

ST-4D, 4ED

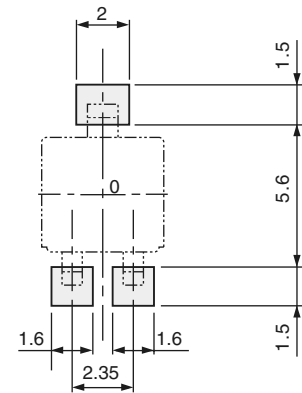

(Unit: mm)

ST-4G, 4EG

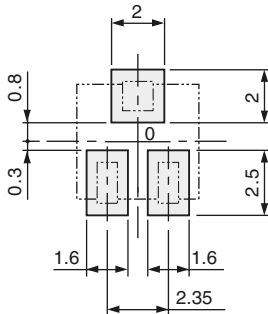

ST-4H, 4EH

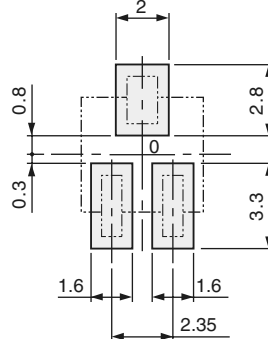

Note) The zero point is the center of mounting.

Specifications are subject to change without notice. Specifications in this catalog are for reference. The formal specification sheets will be submitted upon request.

DIMENSIONS in millimeters

Unless otherwise specified, tolerance: ± 0.3 (Unit: mm)

OUTLINE DIMENSIONS

ST-4A, 4EA
Top adjustment

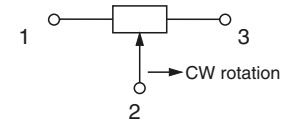
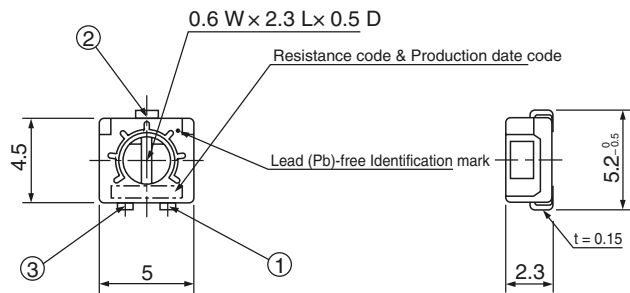

*: Note the terminal position.

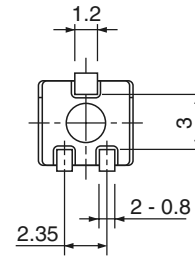

ST-4B, 4EB
Top adjustment

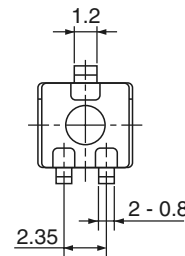
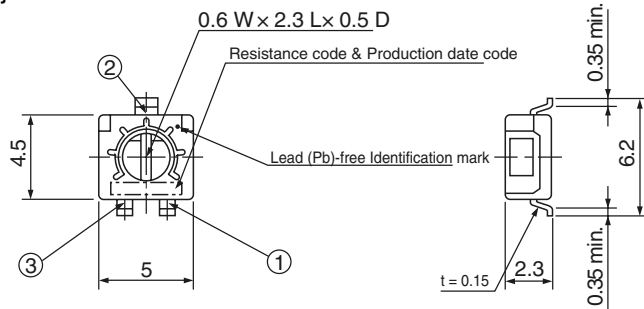

ST-4C, 4EC
Top adjustment

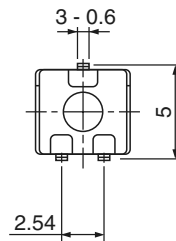
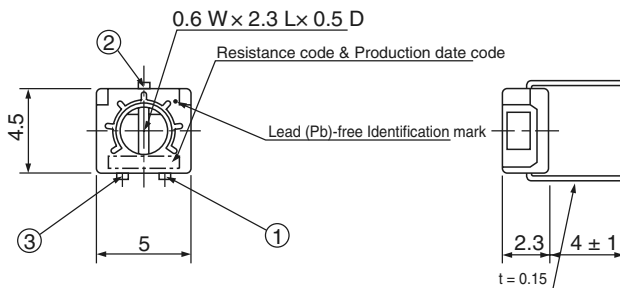

ST-4G, 4EG
Side adjustment

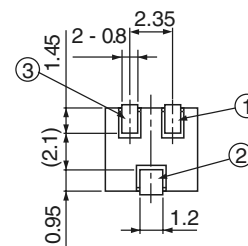
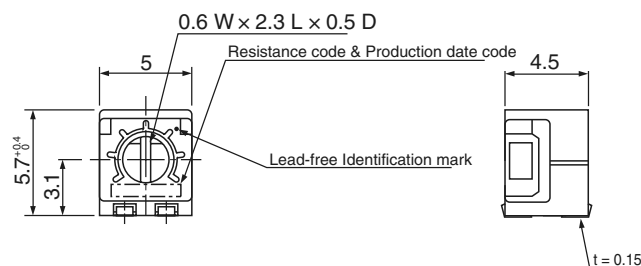

Specifications are subject to change without notice. Specifications in this catalog are for reference. The formal specification sheets will be submitted upon request.

DIMENSIONS in millimeters

OUTLINE DIMENSIONS

Unless otherwise specified, tolerance: ± 0.3 (Unit: mm)

ST-4H, 4EH
Side adjustment

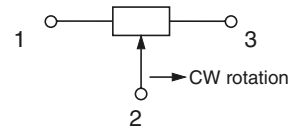
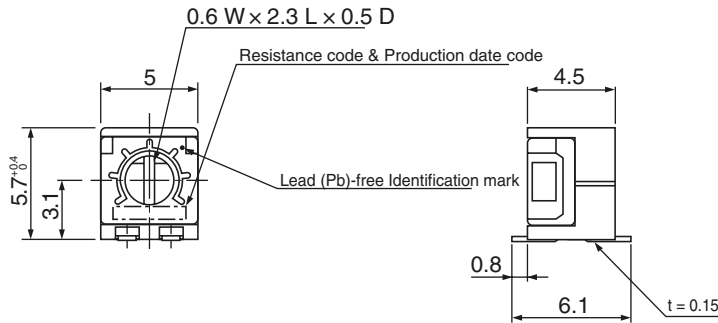

*: Note the terminal position.

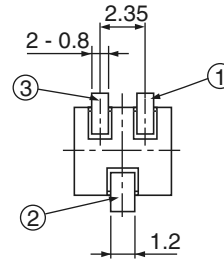

ST-4D, 4ED
Rear adjustment

<Semi-standard products>

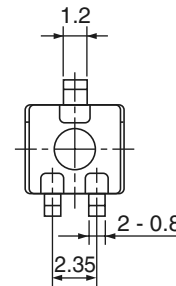
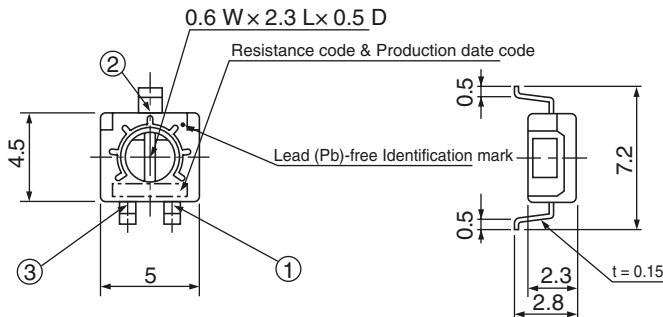

ST-4F, 4EF
Rear adjustment

<Semi-standard products>

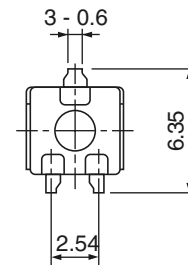
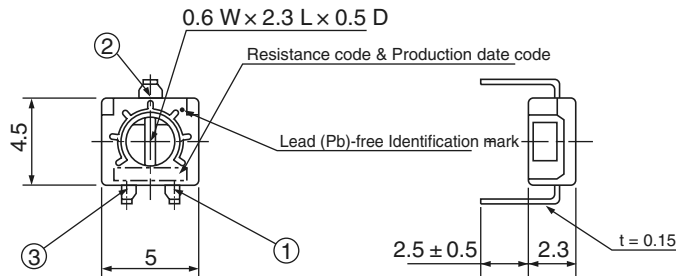

ST-42, 42E
CROSS SLOT DIMENSION

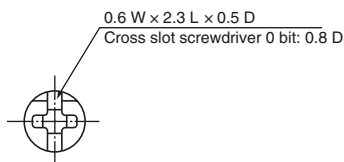

Specifications are subject to change without notice. Specifications in this catalog are for reference. The formal specification sheets will be submitted upon request.

PACKAGING SPECIFICATIONS

Taping packaging specifications

- Taping version is packaged in 500 pcs. per reel.
- Orders will be accepted for units of 500 pcs., i.e., 500, 1000, 1500 pcs., etc.
- ST-4TA, TB, TD, ETA, ETB and ETD versions are boxed with 4 reels (2000 pcs.).
- ST-4TG, TH, ETG and ETH versions are boxed with one reel (500 pcs.).

Maximum number of consecutive missing pieces = 2
 Leader length and reel dimension are shown in the dia-grams below.

EMBOSSED TAPE DIMENSIONS

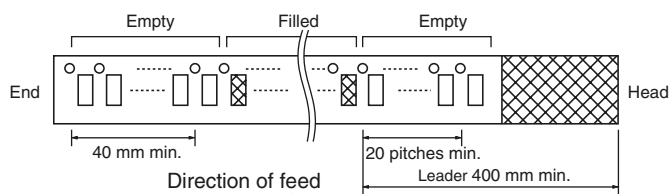

REEL DIMENSIONS

(Conforms to JIS C 0806-3)
 (In accordance with EIAJ ET-7200A)

(Unit: mm)

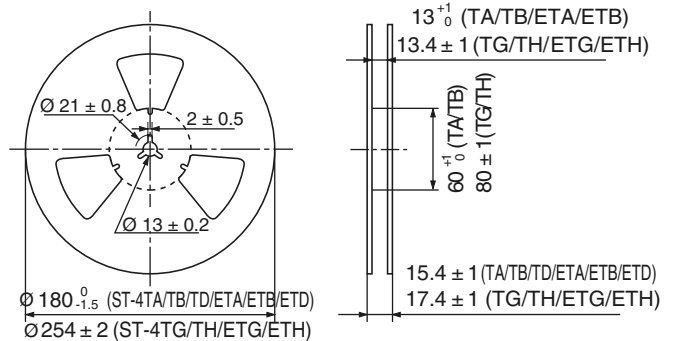

ST-4TA/TB/TD/ETA/ETB/ETD

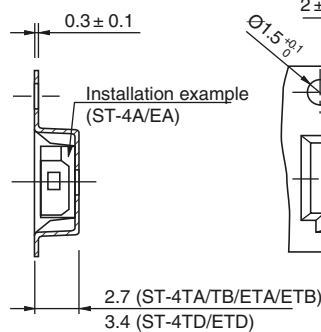
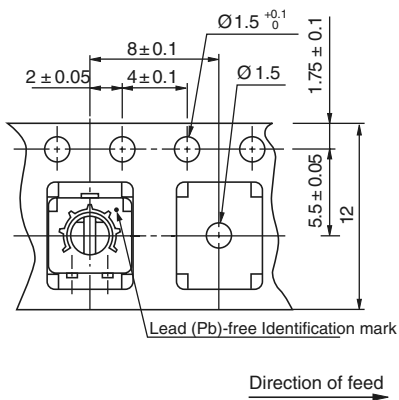

ST-4TG/TH/ETG/ETH

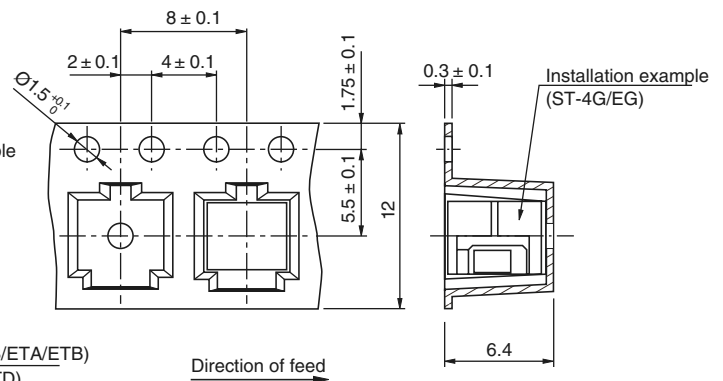

Vinyl bag packaging specifications

- Unit of bulk in vinyl bag packaging is 100 pcs. per pack.
- Boxing of bulk in vinyl bags is performed with 500 pcs. per box.

MECHANICAL SPECIFICATIONS

Mechanical angle	240° (1 turn)
Operating torque	10 mN m {102 gf cm} maximum
Stop strength	30 mN m {306 gf cm} minimum
Rotational life	100 cycles [$\Delta R/R \leq \pm (2 \Omega + 3 \%)$]
Thrust to rotor	5 N {0.51 kgf} minimum
Solderability	Sn-Pb: 235 °C, 2 s Sn-Cu (Lead (Pb)-free): 245 ± 3 °C, 2 ~ 3 s
Shear (Adhesion)	5 N {0.51 kgf} 10 s
Substrate bending	Width 90 mm, bend 3 mm, 5 s, 1 time
Pull-off strength	5 N {0.51 kgf} 10 s

ELECTRICAL SPECIFICATIONS

Nominal resistance range	10 Ω ~ 2 M Ω
Resistance tolerance	± 20 %
Power ratings	0.25 W (70 °C) 0 W (125 °C)
Resistance law	Linear law (B)
Maximum input voltage	DC200 V or power rating, whichever is smaller
Maximum wiper current	100 mA or power rating, whichever is smaller
Effective electrical turn	210° (1 turn)
End resistance	1 % or 2 Ω , whichever is greater
C.R.V.	1 % or 3 Ω , whichever is greater
Operating temp. range	- 55 ~ 125 °C
Temp. coefficient	10 Ω ~ 50 Ω : ± 250 10 ⁻⁶ /°C maximum 100 Ω ~ 2M Ω : ± 100 10 ⁻⁶ /°C maximum
Insulation resistance	1000 M Ω minimum (DC500 V)
Dielectric strength	AC500 V, 60 s
Net weight	Approx. 0.12 g (ST-4A, B, C, D, F, EA, EB, EC, ED, EF) Approx. 0.22 g (ST-4G, H, EG, EH)

Reflow profile for soldering heat evolution

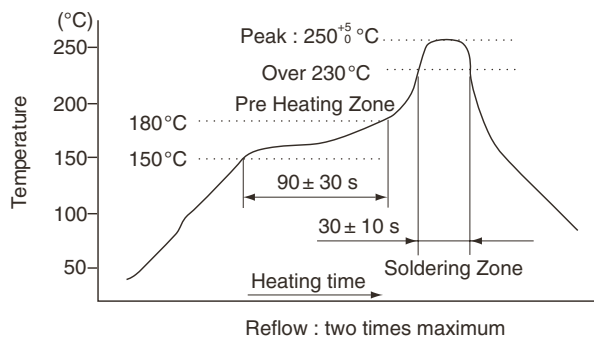
**ENVIRONMENTAL SPECIFICATIONS**

Test item	Test conditions	Specifications
Thermal shock	- 65 ~ 125 °C (0.5 h), 5 cycles	[$\Delta R/R \leq 2 \%$] [S.S. ≤ 1 %]
Humidity	- 10 ~ 65 °C (Relative humidity 80 ~ 98 %), 10 cycles, 240 h	[$\Delta R/R \leq 2 \%$]
Shock	981 m/s ² , 6 ms 6 directions for 3 times each	[$\Delta R/R \leq 1 \%$] [S.S. ≤ 1 %]
Vibration	Amplitude 1.52 mm or Acceleration 196 m/s ² , 10 ~ 2000 Hz, 3 directions, 12 times each	
Load Life	70 °C, 0.25 W, 1000 h	[$\Delta R/R \leq 3 \%$] [S.S. ≤ 1 %]
Low temperature operation	- 55 °C, 2 h	[$\Delta R/R \leq 2 \%$] [S.S. ≤ 2 %]
High temperature exposure	125 °C, 250 h	[$\Delta R/R \leq 3 \%$] [S.S. ≤ 2 %]
Immersion seal	85 °C, 60 s	No leaks (No continuous bubbles)
Soldering heat	Sn-Pb 260 °C, 10 s or 215 °C, 35 s Sn-Cu Flow: 260 °C ± 3 °C as the temperature in a pot of molten solder, immersion from head of terminal to backside of board, 5 ~ 6 s, two times maximum Reflow: Peak temperature 255 °C (Please refer to the profile below.) Manual soldering: 350 ± 10 °C, 3 ~ 4 s	[$\Delta R/R \leq 1 \%$]

MAXIMUM INPUT RATINGS			
Nominal resistance values (Ω)	Resistance code	Maximum input voltage (V)	Maximum wiper current (mA)
10*	100	1.00	100
20*	200	2.00	100
50	500	3.53	70.7
100	101	5.00	50.0
200	201	7.07	35.4
500	501	11.2	22.4
<hr/>			
1 k	102	15.8	15.8
2 k	202	22.4	11.2
5 k	502	35.4	7.07
10 k	103	50.0	5.00
20 k	203	70.7	3.54
50 k	503	112	2.24
<hr/>			
100 k	104	158	1.58
200 k	204	200	1.00
500 k	504	200	0.40
1 M	105	200	0.20
2 M	205	200	0.10

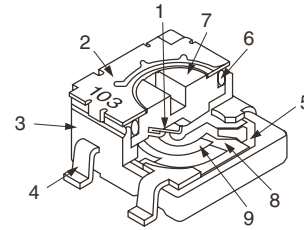

CONSTRUCTION			
Part Name		Material	Flammability
1	Wiper	Multi metal alloy	-
2	Cover	Stainless steel (SUS 304)	
3	Housing	Epoxy	UL-94V-O
4	Terminal pin	Sn-Pb	-
		Sn-Cu	
5	Base element	Ceramic	
6	"O" ring	Silicone rubber	UL-94HB
7	Rotor	Polyphenylenesulphide	UL-94V-O
8	Electrode	Ag-Pd cermet	-
9	Resistive element	RuO2 cermet	

The products indicated by * mark are manufactured upon receipt of order basis

CFC's, Halon, Carbon tetrachloride and designated bromic flame retardant PBBs and PBBs are not used in our products.

LIST OF PART NUMBERS					
Adjustment position	Shape of terminal	Form of packing			
		Taping (reel)		Magazine (stick)	
		Sn-Pb	Sn (Lead (Pb)-free)	Sn-Pb	Sn (Lead (Pb)-free)
Top adjustment	A (J-hook)	ST-4/42TA	ST-4/42ETA	ST-4/42A	ST-4/42EA
	B (Gull wing)	ST-4/42TB	ST-4/42ETB	ST-4/42B	ST-4/42EB
	C (Through hole pins)	-	-	ST-4/42C	ST-4/42EC
Rear adjustment	D (Gull-wing)	ST-4/42TD*	ST-4/42ETD*	ST-4/42D*	ST-4/42ED*
	F (Through hole pins)	-	-	ST-4/42F*	ST-4/42EF*
Side adjustment	G (J-hook)	ST-54/42TG	ST-4/42ETG	ST-4/42G	ST-4/42EG
	H (Gull-wing)	ST-4/42TH	ST-4/42ETH	ST-4/42H	ST-4/42EH
Pieces in package		500 pcs./reel		100 pcs./reel	

The products indicated by * mark are manufactured upon receipt of order basis.

* Slot: ST-4 □ □ Slot: -42 □ □



FIG.1: NOMINAL RESISTANCE VALUES								
10 Ω*	20 Ω*	50 Ω	100 Ω	200 Ω	500 Ω	1 kΩ	2 kΩ	5 kΩ
10 kΩ	20 kΩ	50 kΩ	100 kΩ	200 kΩ	500 kΩ	1 MΩ	2 MΩ	-

Not manufactured

* The above part numbers are all available with the respective combination of <Nominal resistance values> (Fig.1)

* Verify the above part numbers when placing orders.

* Taping specification is not sold separately and must be purchased in reel units.

ORDERING INFORMATION				
ST-4		T	A	204
SERIES NAME (MINUS SLOT)	TERMINAL PIN	FORM OF PACKAGING	PRODUCT SHAPE (SHAPE OF TERMINAL)	RESISTANCE CODE
	Blank: Sn-Pb E: Sn (Lead(Pb)-free)	T: Taping (Reel) Blank: Bulk in vinyl bags	A, G: J-hook B, D, H: Gull wing C; F: Through hole pins	

ORDERING INFORMATION				
ST-4 2		T	A	204
SERIES NAME (CROSS SLOT)	TERMINAL PIN	FORM OF PACKAGING	PRODUCT SHAPE (SHAPE OF TERMINAL)	RESISTANCE CODE
	Blank: Sn-Pb E: Sn (Lead-free)	T: Taping (Reel) Blank: Bulk in vinyl bags	A, G: J-hook B, D, H: Gull wing C; F: Through hole pins	

This product is manufactured by Copal Electronics Co. Ltd. of Tokyo, Japan and is distributed by Vishay in North and South America only. This product is not available from Vishay outside of North or South America.



Notice

Specifications of the products displayed herein are subject to change without notice. Vishay Intertechnology, Inc., or anyone on its behalf, assumes no responsibility or liability for any errors or inaccuracies.

Information contained herein is intended to provide a product description only. No license, express or implied, by estoppel or otherwise, to any intellectual property rights is granted by this document. Except as provided in Vishay's terms and conditions of sale for such products, Vishay assumes no liability whatsoever, and disclaims any express or implied warranty, relating to sale and/or use of Vishay products including liability or warranties relating to fitness for a particular purpose, merchantability, or infringement of any patent, copyright, or other intellectual property right.

The products shown herein are not designed for use in medical, life-saving, or life-sustaining applications. Customers using or selling these products for use in such applications do so at their own risk and agree to fully indemnify Vishay for any damages resulting from such improper use or sale.